

December 1993

Low Voltage Reference

Features

- **Low Bias Current - 50µA Min**
- **Low Dynamic Impedance**
- **Low Reverse Voltage**
- **Low Cost**

Description

The ICL8069 is a 1.2V temperature compensated voltage reference. It uses the band-gap principle to achieve excellent stability and low noise at reverse currents down to 50µA. Applications include analog-to-digital converters, digital-to-analog converters, threshold detectors, and voltage regulators. Its low power consumption makes it especially suitable for battery operated equipment.

Ordering Information

PART NUMBER	MAXIMUM TEMPCO	TEMPERATURE RANGE	PACKAGE
ICL8069CCZR	0.005%/°C	0°C to +70°C	TO-92
ICL8069CCSQ	0.005%/°C	0°C to +70°C	TO-52
ICL8069DCZR	0.01%/°C	0°C to +70°C	TO-92
ICL8069DCSQ	0.01%/°C	0°C to +70°C	TO-52
ICL8069CCBA	0.005%/°C	0°C to +70°C	8 Lead SOIC
ICL8069DCBA	0.01%/°C	0°C to +70°C	8 Lead SOIC
ICL8069CMSQ	0.005%/°C	-55°C to +125°C	TO-52
ICL8069DMSQ	0.01%/°C	-55°C to +125°C	TO-52

Pinouts

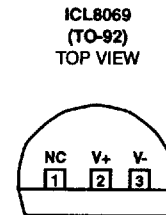
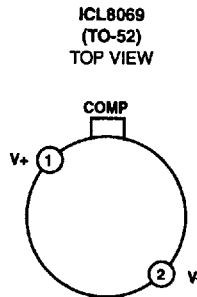
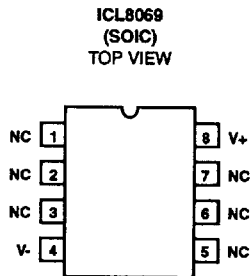

Functional Block Diagrams

SIMPLE REFERENCE (1.2V OR LESS)

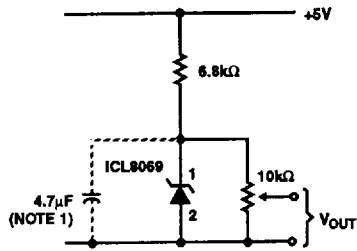

BUFFERED 10V REFERENCE USING A SINGLE SUPPLY

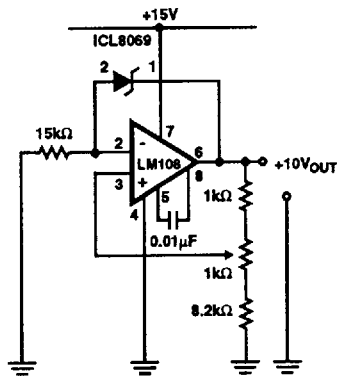

DOUBLE REGULATED 100mV REFERENCE FOR ICL7107 ONE-CHIP DPM CIRCUIT

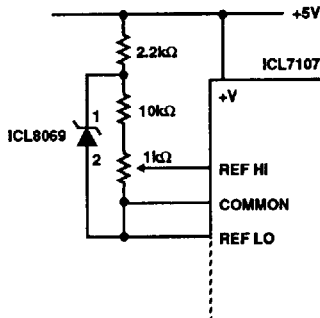

Specifications ICL8069

Absolute Maximum Ratings

Reverse Voltage See Note 2
 Forward Current 10mA
 Reverse Current 10mA
 Storage Temperature -65°C to +150°C
 Lead Temperature (Soldering, 10s) +300°C
 Junction Temperature
 SOP +150°C

Thermal Information

Thermal Resistance θ_{JA}
 SOIC Package 160°C/W
 Operating Temperature
 ICL8069C 0°C to +70°C
 ICL8069M -55°C to +125°C
 Power Dissipation Limited by MAX Forward/Reverse Current

Electrical Specifications $T_A = +25^\circ\text{C}$ Unless Otherwise Specified

PARAMETERS	TEST CONDITIONS	MIN	TYP	MAX	UNITS
Reverse Breakdown Voltage	$I_R = 500\mu\text{A}$	1.20	1.23	1.25	V
Reverse Breakdown Voltage Change	$50\mu\text{A} \leq I_R \leq 5\text{mA}$	-	15	20	mV
Reverse Dynamic Impedance	$I_R = 50\mu\text{A}$	-	1	2	Ω
	$I_R = 500\mu\text{A}$	-	1	2	Ω
Forward Voltage Drop	$I_F = 500\mu\text{A}$	-	0.7	1	V
RMS Noise Voltage	$10\text{Hz} \leq F \leq 10\text{kHz}$ $I_R = 500\mu\text{A}$	-	5	-	μV
Long Term Stability	$I_R = 4.75\text{mA}$ $T_A = +25^\circ\text{C}$	-	1	-	ppm/kHR
Breakdown Voltage Temperature Coefficient	$I_R = 500\mu\text{A}$, $T_A = \text{Operating Temperature Range (Note 3)}$	-	-	0.005	%/°C
		-	-	0.01	%/°C
Reverse Current Range	1.18V to 1.27V	0.050	-	5	mA

NOTES:

1. If circuit strays in excess of 200pF are anticipated, a 4.7 μF shunt capacitor will ensure stability under all operating conditions.
2. In normal use, the reverse voltage cannot exceed the reference voltage. However when plugging units into a powered-up test fixture, an instantaneous voltage equal to the compliance of the test circuit will be seen. This should not exceed 20V.
3. For the military part, measurements are made at +25°C, -55°C, and +125°C. The unit is then classified as a function of the worst case TC from +25°C to -55°C, or +25°C to +125°C.

14
SPECIAL PURPOSE

Typical Performance Curves

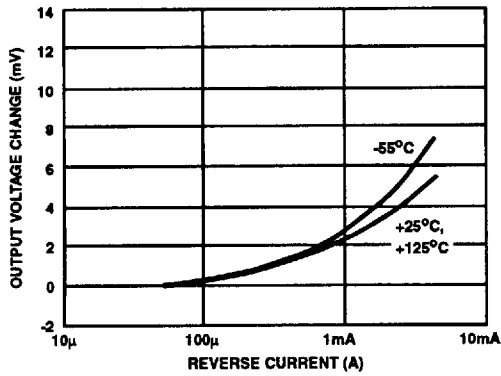

FIGURE 1. VOLTAGE CHANGE AS A FUNCTION OF REVERSE CURRENT

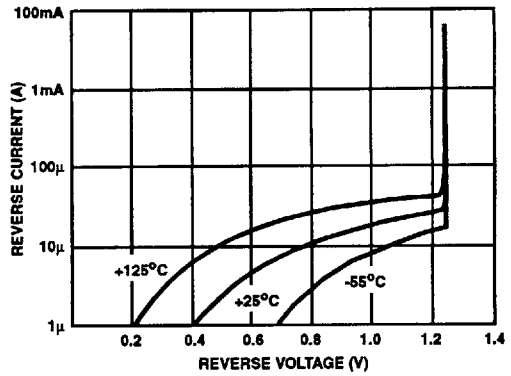

FIGURE 2. REVERSE VOLTAGE AS A FUNCTION OF CURRENT

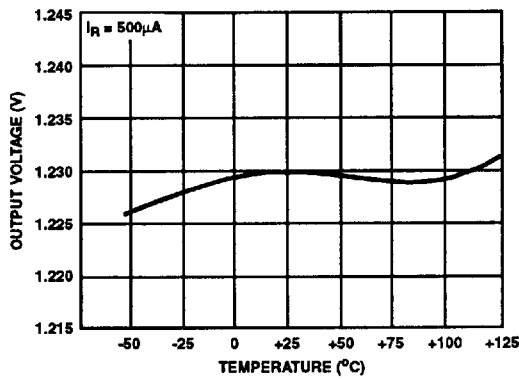

FIGURE 3. REVERSE VOLTAGE AS A FUNCTION OF TEMPERATURE