



PBL2004D

20 V PNP BISS loadswitch

Rev. 01 — 23 June 2005

Product data sheet

1. Product profile

1.1 General description

PNP low V_{CEsat} Breakthrough in Small Signal (BISS) transistor and NPN Resistor-Equipped Transistor (RET) in a SOT457 (SC-74) small Surface Mounted Device (SMD) plastic package.

1.2 Features

- Low V_{CEsat} (BISS) and resistor-equipped transistor in one package
- Low threshold voltage (< 1 V) compared to MOSFET
- Low drive power required
- Space-saving solution
- Reduction of component count

1.3 Applications

- Supply line switches
- Battery charger switches
- High-side switches for LEDs, drivers and backlights
- Portable equipment

1.4 Quick reference data

Table 1: Quick reference data

Symbol	Parameter	Conditions	Min	Typ	Max	Unit
TR1; PNP low V_{CEsat} transistor						
V_{CEO}	collector-emitter voltage	open base	-	-	-20	V
I_C	collector current (DC)		-	-	-1	A
R_{CEsat}	collector-emitter saturation resistance	$I_C = -1$ A; $I_B = -100$ mA	[1]	185	280	m Ω
TR2; NPN resistor-equipped transistor						
V_{CEO}	collector-emitter voltage	open base	-	-	50	V
I_O	output current		-	-	100	mA
R1	bias resistor 1 (input)		15.4	22	28.6	k Ω
R2/R1	bias resistor ratio		0.8	1	1.2	

[1] Pulse test: $t_p \leq 300$ μ s; $\delta \leq 0.02$.

PHILIPS

2. Pinning information

Table 2: Pinning

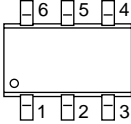
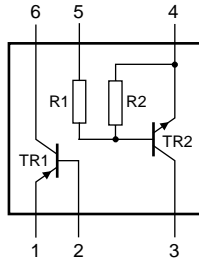
Pin	Description	Simplified outline	Symbol
1	emitter TR1		
2	base TR1		
3	output (collector) TR2		
4	GND (emitter) TR2		
5	input (base) TR2		
6	collector TR1		

sym036

3. Ordering information

Table 3: Ordering information

Type number	Package		
	Name	Description	Version
PBLS2004D	SC-74	plastic surface mounted package; 6 leads	SOT457

4. Marking

Table 4: Marking codes

Type number	Marking code
PBLS2004D	F9

5. Limiting values

Table 5: Limiting values

In accordance with the Absolute Maximum Rating System (IEC 60134).

Symbol	Parameter	Conditions	Min	Max	Unit	
TR1; PNP low V_{CEsat} transistor						
V_{CBO}	collector-base voltage	open emitter	-	-20	V	
V_{CEO}	collector-emitter voltage	open base	-	-20	V	
V_{EBO}	emitter-base voltage	open collector	-	-5	V	
I_C	collector current (DC)		-	-1	A	
I_{CM}	peak collector current	$t_p \leq 300 \mu s$	-	-2	A	
I_B	base current (DC)		-	-0.3	A	
I_{BM}	peak base current	$t_p \leq 300 \mu s$	-	-0.6	A	
P_{tot}	total power dissipation	$T_{amb} \leq 25 \text{ }^\circ\text{C}$	[1]	-	250	mW
			[2]	-	350	mW
			[3]	-	400	mW

Table 5: Limiting values ...continued

In accordance with the Absolute Maximum Rating System (IEC 60134).

Symbol	Parameter	Conditions	Min	Max	Unit
TR2; NPN resistor-equipped transistor					
V_{CBO}	collector-base voltage	open emitter	-	50	V
V_{CEO}	collector-emitter voltage	open base	-	50	V
V_{EBO}	emitter-base voltage	open collector	-	10	V
V_I	input voltage				
	positive		-	+40	V
	negative		-	-10	V
I_O	output current		-	100	mA
I_{CM}	peak collector current	$t_p \leq 300 \mu s$	-	100	mA
P_{tot}	total power dissipation	$T_{amb} \leq 25 \text{ }^\circ\text{C}$	[1]	200	mW
Per device					
P_{tot}	total power dissipation		[1]	400	mW
			[2]	530	mW
			[3]	600	mW
T_{stg}	storage temperature		-65	+150	$^\circ\text{C}$
T_j	junction temperature		-	150	$^\circ\text{C}$
T_{amb}	ambient temperature		-65	+150	$^\circ\text{C}$

- [1] Device mounted on an FR4 Printed-Circuit Board (PCB), single-sided copper, tin-plated and standard footprint.
- [2] Device mounted on an FR4 PCB, single-sided copper, tin-plated, mounting pad for collector 1 cm².
- [3] Device mounted on a ceramic PCB, Al₂O₃, standard footprint.

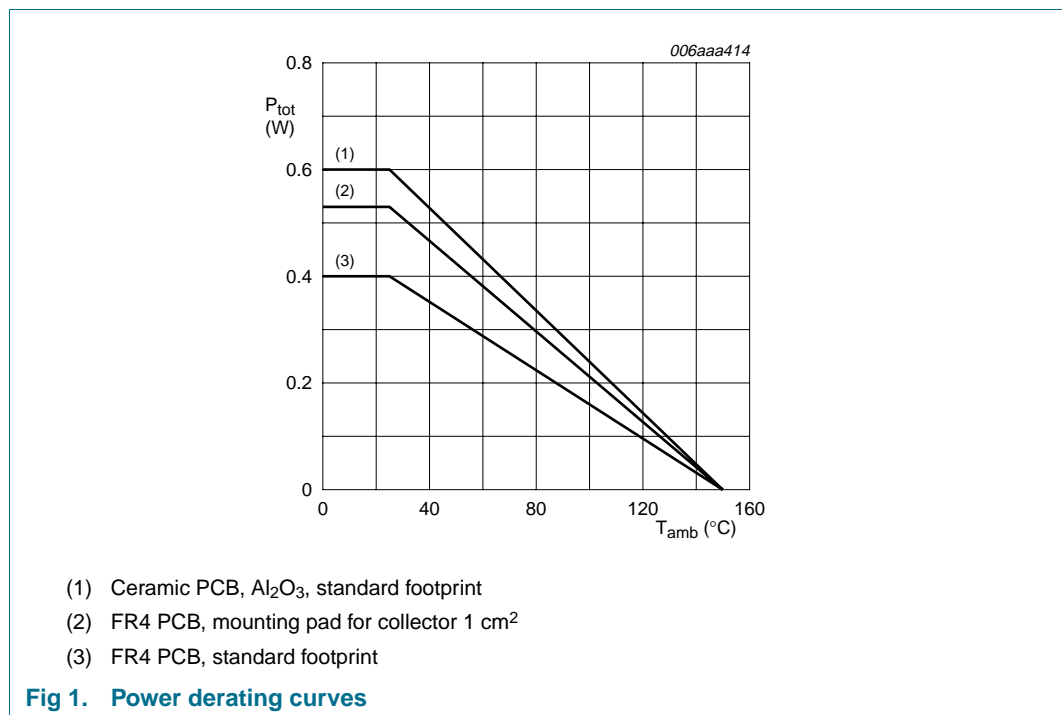

6. Thermal characteristics

Table 6: Thermal characteristics

Symbol	Parameter	Conditions	Min	Typ	Max	Unit	
Per device							
$R_{th(j-a)}$	thermal resistance from junction to ambient	in free air	[1]	-	-	315	K/W
			[2]	-	-	236	K/W
			[3]	-	-	210	K/W

- [1] Device mounted on an FR4 PCB, single-sided copper, tin-plated and standard footprint.
- [2] Device mounted on an FR4 PCB, single-sided copper, tin-plated, mounting pad for collector 1 cm².
- [3] Device mounted on a ceramic PCB, Al₂O₃, standard footprint.

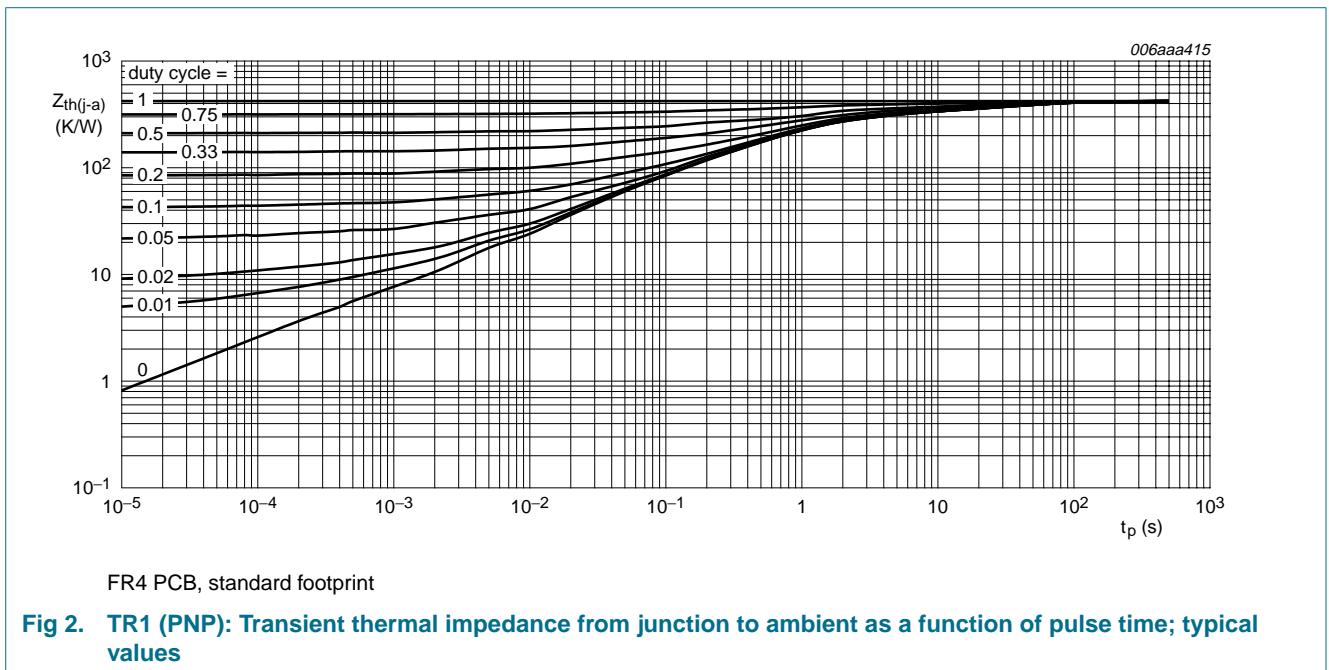

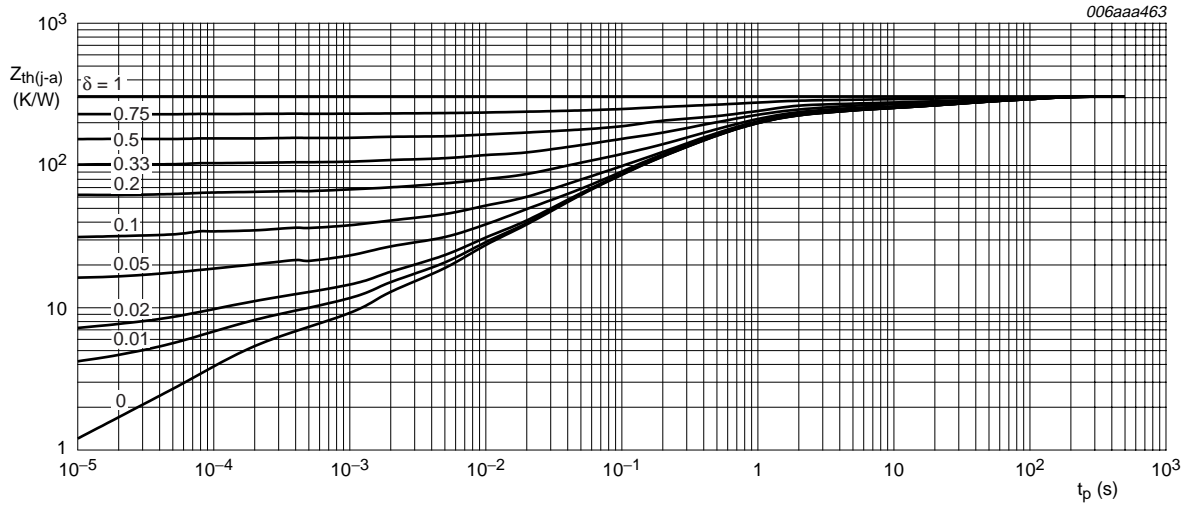

FR4 PCB, mounting pad for collector 1 cm²

Fig 3. TR1 (PNP): Transient thermal impedance from junction to ambient as a function of pulse time; typical values

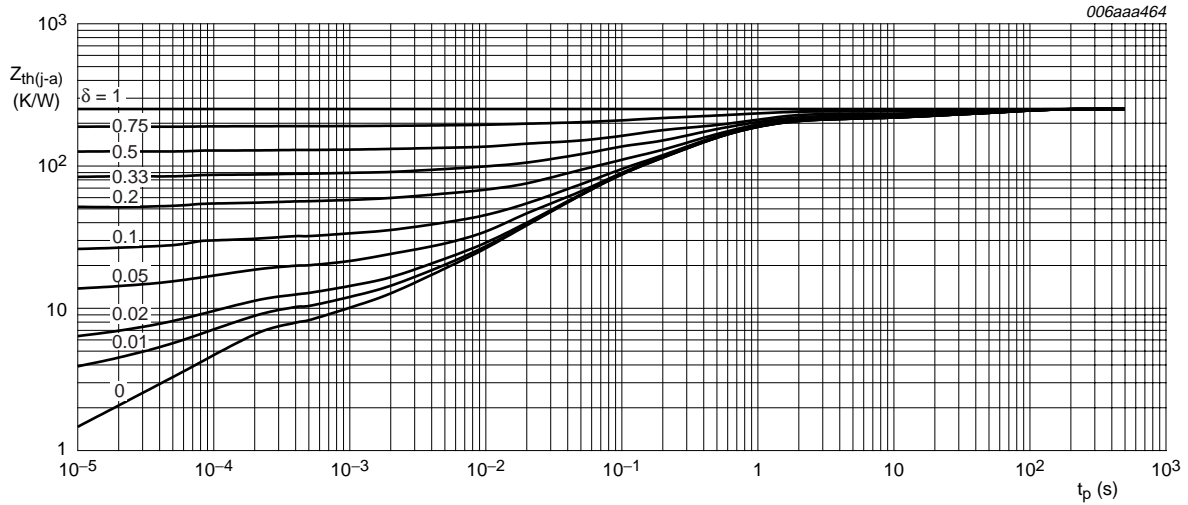

Ceramic PCB, Al₂O₃, standard footprint

Fig 4. TR1 (PNP): Transient thermal impedance from junction to ambient as a function of pulse time; typical values

7. Characteristics

Table 7: Characteristics
T_{amb} = 25 °C unless otherwise specified.

Symbol	Parameter	Conditions	Min	Typ	Max	Unit	
TR1; PNP low V_{CEsat} transistor							
I _{CBO}	collector-base cut-off current	V _{CB} = -20 V; I _E = 0 A	-	-	-0.1	μA	
		V _{CB} = -20 V; I _E = 0 A; T _j = 150 °C	-	-	-50	μA	
I _{CES}	collector-emitter cut-off current	V _{CE} = -20 V; V _{BE} = 0 V	-	-	-0.1	μA	
I _{EBO}	emitter-base cut-off current	V _{EB} = -5 V; I _C = 0 A	-	-	-0.1	μA	
h _{FE}	DC current gain	V _{CE} = -2 V; I _C = -1 mA	220	495	-		
		V _{CE} = -2 V; I _C = -100 mA	220	440	-		
		V _{CE} = -2 V; I _C = -500 mA	[1]	220	310	-	
		V _{CE} = -2 V; I _C = -1 A	[1]	155	220	-	
		V _{CE} = -2 V; I _C = -2 A	[1]	60	120	-	
V _{CEsat}	collector-emitter saturation voltage	I _C = -100 mA; I _B = -1 mA	-	-55	-90	mV	
		I _C = -500 mA; I _B = -50 mA	[1]	-	-100	-150	mV
		I _C = -1 A; I _B = -50 mA	[1]	-	-200	-300	mV
		I _C = -1 A; I _B = -100 mA	[1]	-	-185	-280	mV
R _{CEsat}	collector-emitter saturation resistance	I _C = -1 A; I _B = -100 mA	[1]	-	185	280	mΩ
V _{BEsat}	base-emitter saturation voltage	I _C = -1 A; I _B = -50 mA	[1]	-	-0.95	-1.1	V
		I _C = -1 A; I _B = -100 mA	[1]	-	-1	-1.1	V
V _{BEon}	base-emitter turn-on voltage	V _{CE} = -5 V; I _C = -1 A	[1]	-	-0.85	-1.1	V
t _d	delay time	I _C = -1 A; I _{Bon} = -50 mA;	-	8	-	ns	
t _r	rise time	I _{Boff} = 50 mA	-	34	-	ns	
t _{on}	turn-on time		-	42	-	ns	
t _s	storage time		-	140	-	ns	
t _f	fall time		-	45	-	ns	
t _{off}	turn-off time		-	185	-	ns	
f _T	transition frequency	I _C = -50 mA; V _{CE} = -10 V; f = 100 MHz	150	185	-	MHz	
C _c	collector capacitance	V _{CB} = -10 V; I _E = I _e = 0 A; f = 1 MHz	-	15	20	pF	

Table 7: Characteristics ...continued $T_{amb} = 25\text{ °C}$ unless otherwise specified.

Symbol	Parameter	Conditions	Min	Typ	Max	Unit
TR2; NPN resistor-equipped transistor						
I_{CBO}	collector-base cut-off current	$V_{CB} = 50\text{ V}; I_E = 0\text{ A}$	-	-	100	nA
I_{CEO}	collector-emitter cut-off current	$V_{CE} = 30\text{ V}; I_B = 0\text{ A}$	-	-	1	μA
		$V_{CE} = 30\text{ V}; I_B = 0\text{ A}; T_j = 150\text{ °C}$	-	-	50	μA
I_{EBO}	emitter-base cut-off current	$V_{EB} = 5\text{ V}; I_C = 0\text{ A}$	-	-	180	μA
h_{FE}	DC current gain	$V_{CE} = 5\text{ V}; I_C = 5\text{ mA}$	60	-	-	
V_{CEsat}	collector-emitter saturation voltage	$I_C = 10\text{ mA}; I_B = 0.5\text{ mA}$	-	-	150	mV
$V_{I(off)}$	off-state input voltage	$V_{CE} = 5\text{ V}; I_C = 100\text{ }\mu\text{A}$	-	1.1	0.8	V
$V_{I(on)}$	on-state input voltage	$V_{CE} = 0.3\text{ V}; I_C = 5\text{ mA}$	2.5	1.7	-	V
R1	bias resistor 1 (input)		15.4	22	28.6	k Ω
R2/R1	bias resistor ratio		0.8	1	1.2	
C_c	collector capacitance	$V_{CB} = 10\text{ V}; I_E = i_e = 0\text{ A}; f = 1\text{ MHz}$	-	-	2.5	pF

[1] Pulse test: $t_p \leq 300\text{ }\mu\text{s}; \delta \leq 0.02$.

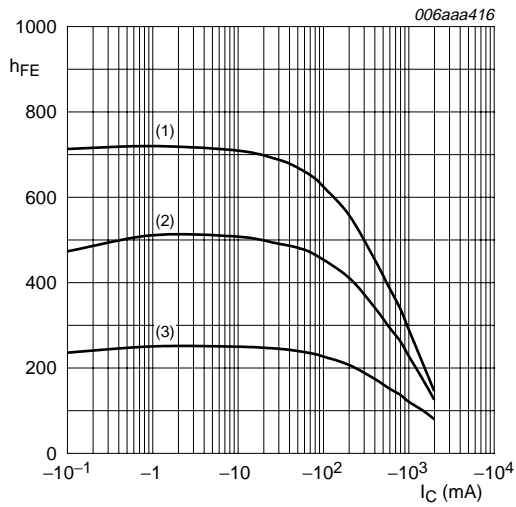

$V_{CE} = -2\text{ V}$
 (1) $T_{amb} = 100\text{ }^{\circ}\text{C}$
 (2) $T_{amb} = 25\text{ }^{\circ}\text{C}$
 (3) $T_{amb} = -55\text{ }^{\circ}\text{C}$

Fig 5. TR1 (PNP): DC current gain as a function of collector current; typical values

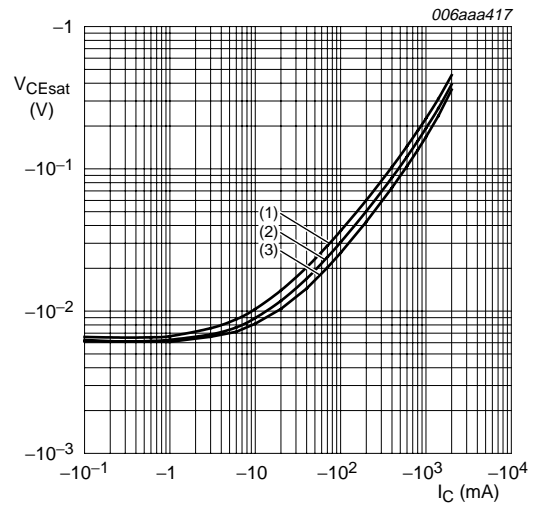

$I_C/I_B = 20$
 (1) $T_{amb} = 100\text{ }^{\circ}\text{C}$
 (2) $T_{amb} = 25\text{ }^{\circ}\text{C}$
 (3) $T_{amb} = -55\text{ }^{\circ}\text{C}$

Fig 6. TR1 (PNP): Collector-emitter saturation voltage as a function of collector current; typical values

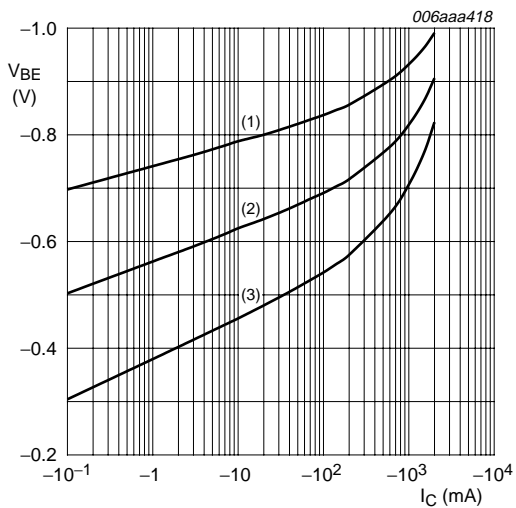

$V_{CE} = -5\text{ V}$
 (1) $T_{amb} = -55\text{ }^{\circ}\text{C}$
 (2) $T_{amb} = 25\text{ }^{\circ}\text{C}$
 (3) $T_{amb} = 100\text{ }^{\circ}\text{C}$

Fig 7. TR1 (PNP): Base-emitter voltage as a function of collector current; typical values

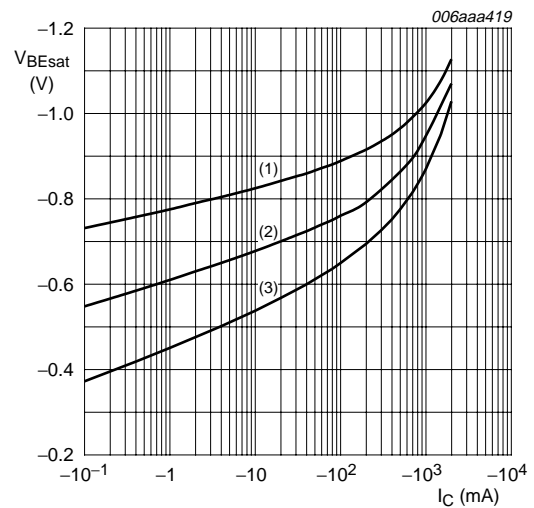

$I_C/I_B = 20$
 (1) $T_{amb} = -55\text{ }^{\circ}\text{C}$
 (2) $T_{amb} = 25\text{ }^{\circ}\text{C}$
 (3) $T_{amb} = 100\text{ }^{\circ}\text{C}$

Fig 8. TR1 (PNP): Base-emitter saturation voltage as a function of collector current; typical values

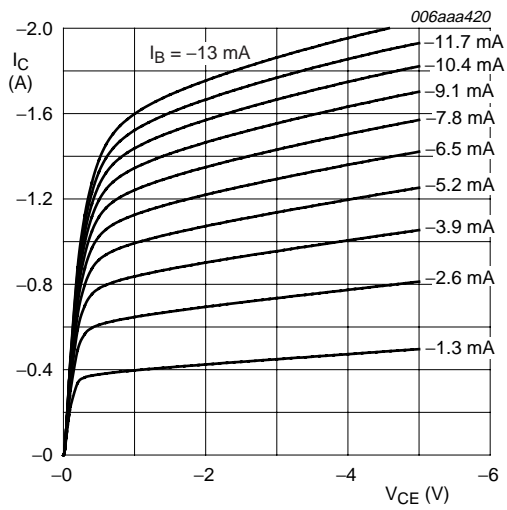

$T_{amb} = 25$ °C

Fig 9. TR1 (PNP): Collector current as a function of collector-emitter voltage; typical values

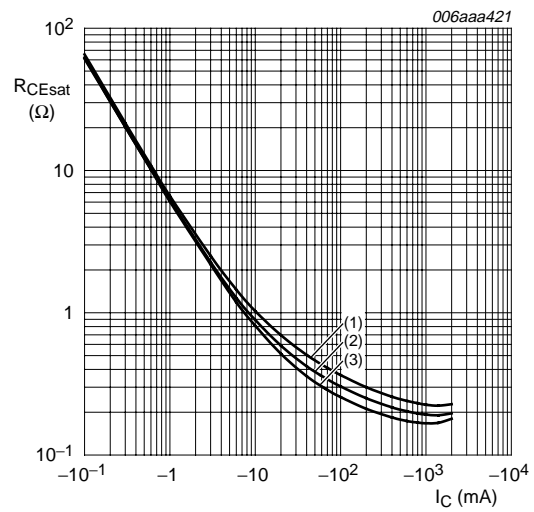

$I_C/I_B = 20$

- (1) $T_{amb} = 100$ °C
- (2) $T_{amb} = 25$ °C
- (3) $T_{amb} = -55$ °C

Fig 10. TR1 (PNP): Collector-emitter saturation resistance as a function of collector current; typical values

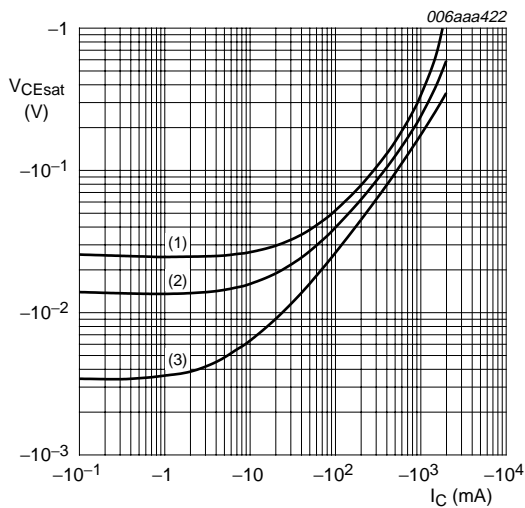

$T_{amb} = 25$ °C

- (1) $I_C/I_B = 100$
- (2) $I_C/I_B = 50$
- (3) $I_C/I_B = 10$

Fig 11. TR1 (PNP): Collector-emitter saturation voltage as a function of collector current; typical values

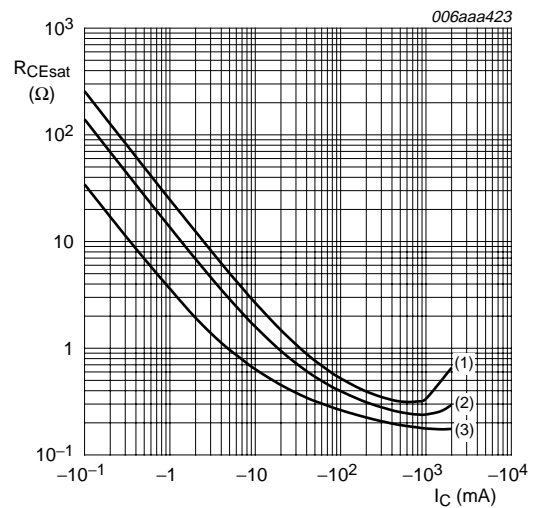

$T_{amb} = 25$ °C

- (1) $I_C/I_B = 100$
- (2) $I_C/I_B = 50$
- (3) $I_C/I_B = 10$

Fig 12. TR1 (PNP): Collector-emitter saturation resistance as a function of collector current; typical values

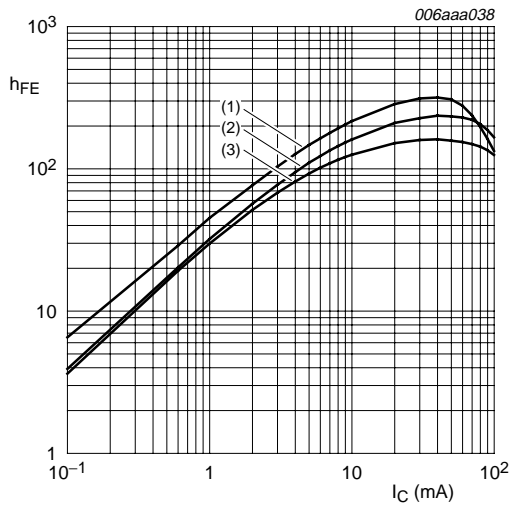

$V_{CE} = 5 \text{ V}$
 (1) $T_{amb} = 150 \text{ }^\circ\text{C}$
 (2) $T_{amb} = 25 \text{ }^\circ\text{C}$
 (3) $T_{amb} = -40 \text{ }^\circ\text{C}$

Fig 13. TR2 (NPN): DC current gain as a function of collector current; typical values

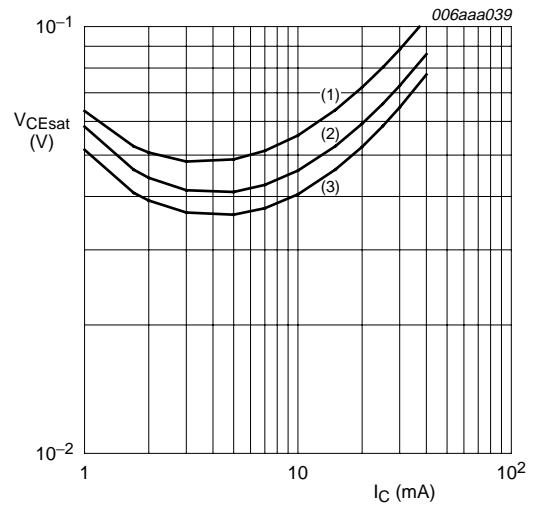

$I_C/I_B = 20$
 (1) $T_{amb} = 100 \text{ }^\circ\text{C}$
 (2) $T_{amb} = 25 \text{ }^\circ\text{C}$
 (3) $T_{amb} = -40 \text{ }^\circ\text{C}$

Fig 14. TR2 (NPN): Collector-emitter saturation voltage as a function of collector current; typical values

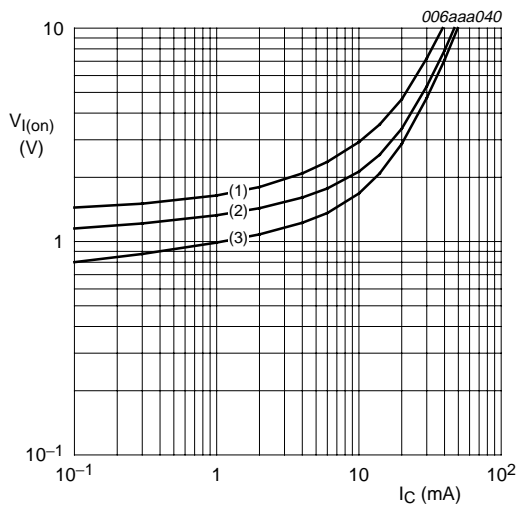

$V_{CE} = 0.3 \text{ V}$
 (1) $T_{amb} = -40 \text{ }^\circ\text{C}$
 (2) $T_{amb} = 25 \text{ }^\circ\text{C}$
 (3) $T_{amb} = 100 \text{ }^\circ\text{C}$

Fig 15. TR2 (NPN): On-state input voltage as a function of collector current; typical values

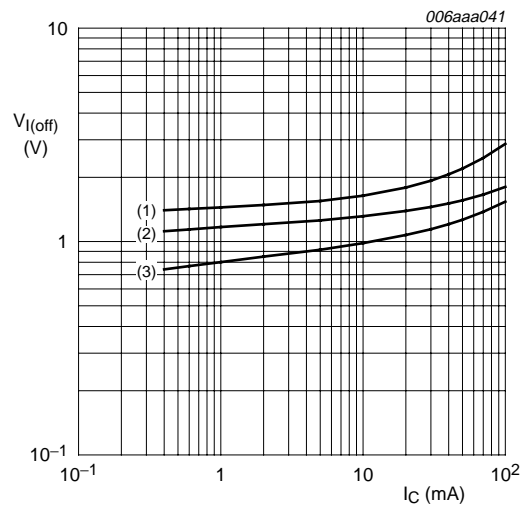

$V_{CE} = 5 \text{ V}$
 (1) $T_{amb} = -40 \text{ }^\circ\text{C}$
 (2) $T_{amb} = 25 \text{ }^\circ\text{C}$
 (3) $T_{amb} = 100 \text{ }^\circ\text{C}$

Fig 16. TR2 (NPN): Off-state input voltage as a function of collector current; typical values

8. Test information

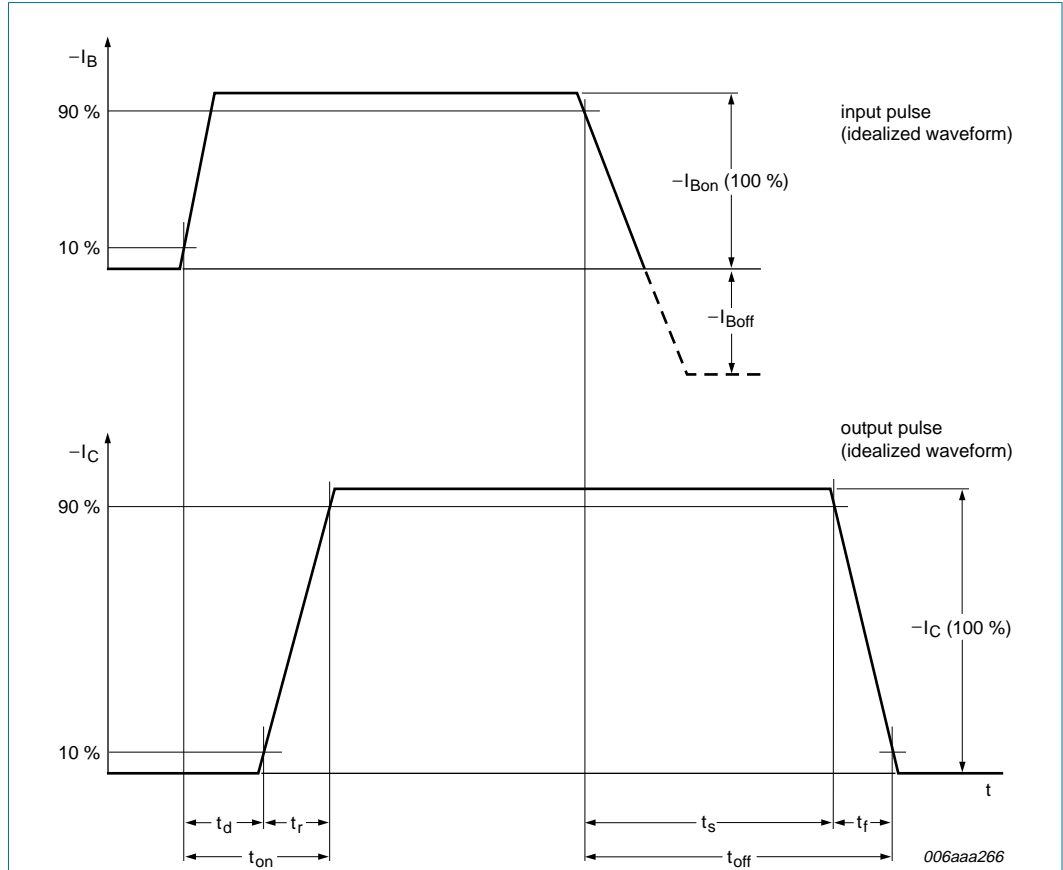
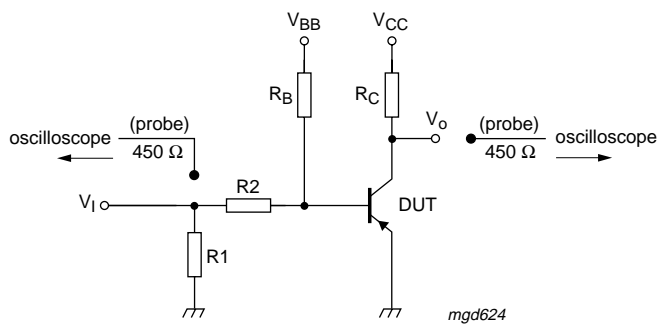

Fig 17. BISS transistor switching time definition



$I_C = -1\text{ A}$; $I_{B_{on}} = -50\text{ mA}$; $I_{B_{off}} = 50\text{ mA}$; $R_1 = \text{open}$; $R_2 = 45\ \Omega$; $R_B = 145\ \Omega$; $R_C = 10\ \Omega$

Fig 18. Test circuit for switching times

9. Package outline

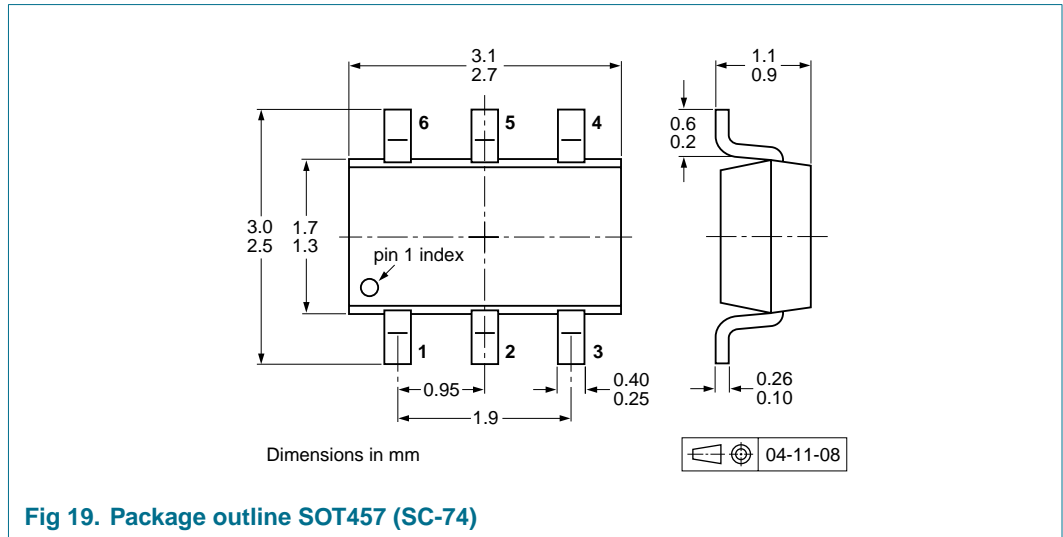

10. Packing information

Table 8: Packing methods

The indicated -xxx are the last three digits of the 12NC ordering code. [\[1\]](#)

Type number	Package	Description	Packing quantity	
			3000	10000
PBLS2004D	SOT457	4 mm pitch, 8 mm tape and reel; T1	[2] -115	-135
		4 mm pitch, 8 mm tape and reel; T2	[3] -125	-165

[1] For further information and the availability of packing methods, see [Section 17](#).

[2] T1: normal taping

[3] T2: reverse taping

11. Soldering

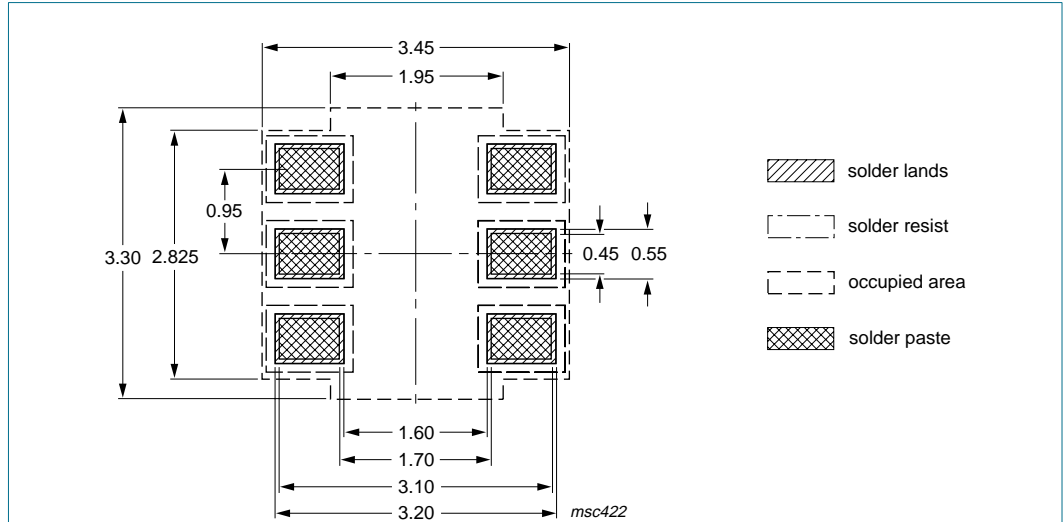

Dimensions in mm

Fig 20. Reflow soldering footprint

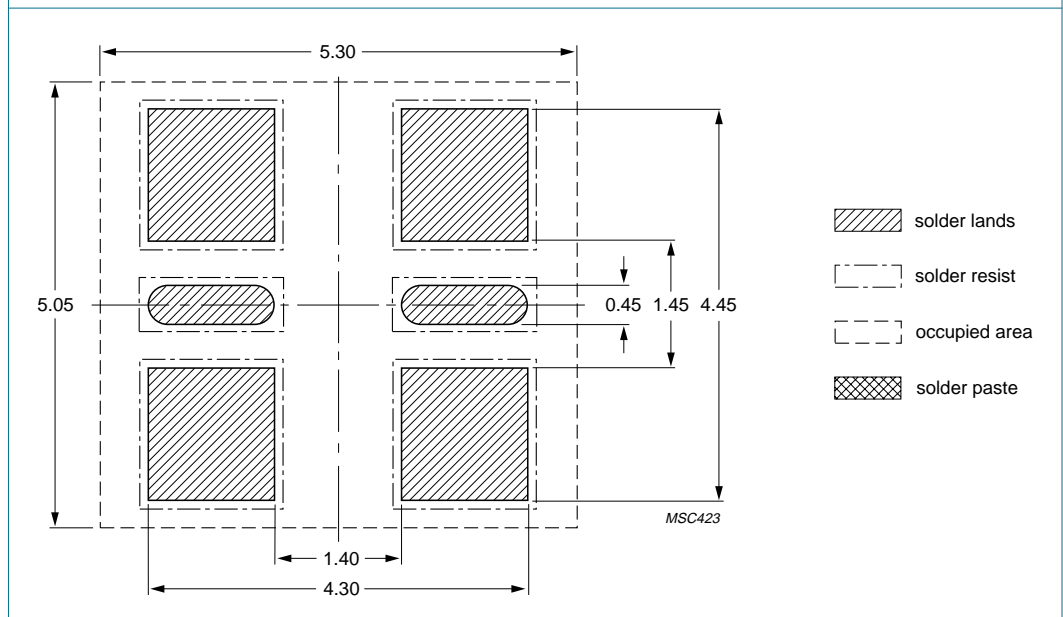

Dimensions in mm

Fig 21. Wave soldering footprint



12. Revision history

Table 9: Revision history

Document ID	Release date	Data sheet status	Change notice	Doc. number	Supersedes
PBLS2004D_1	20050623	Product data sheet	-	-	-

13. Data sheet status

Level	Data sheet status ^[1]	Product status ^{[2] [3]}	Definition
I	Objective data	Development	This data sheet contains data from the objective specification for product development. Philips Semiconductors reserves the right to change the specification in any manner without notice.
II	Preliminary data	Qualification	This data sheet contains data from the preliminary specification. Supplementary data will be published at a later date. Philips Semiconductors reserves the right to change the specification without notice, in order to improve the design and supply the best possible product.
III	Product data	Production	This data sheet contains data from the product specification. Philips Semiconductors reserves the right to make changes at any time in order to improve the design, manufacturing and supply. Relevant changes will be communicated via a Customer Product/Process Change Notification (CPCN).

[1] Please consult the most recently issued data sheet before initiating or completing a design.

[2] The product status of the device(s) described in this data sheet may have changed since this data sheet was published. The latest information is available on the Internet at URL <http://www.semiconductors.philips.com>.

[3] For data sheets describing multiple type numbers, the highest-level product status determines the data sheet status.

14. Definitions

Short-form specification — The data in a short-form specification is extracted from a full data sheet with the same type number and title. For detailed information see the relevant data sheet or data handbook.

Limiting values definition — Limiting values given are in accordance with the Absolute Maximum Rating System (IEC 60134). Stress above one or more of the limiting values may cause permanent damage to the device. These are stress ratings only and operation of the device at these or at any other conditions above those given in the Characteristics sections of the specification is not implied. Exposure to limiting values for extended periods may affect device reliability.

Application information — Applications that are described herein for any of these products are for illustrative purposes only. Philips Semiconductors make no representation or warranty that such applications will be suitable for the specified use without further testing or modification.

15. Disclaimers

Life support — These products are not designed for use in life support appliances, devices, or systems where malfunction of these products can reasonably be expected to result in personal injury. Philips Semiconductors

17. Contact information

For additional information, please visit: <http://www.semiconductors.philips.com>

For sales office addresses, send an email to: sales.addresses@www.semiconductors.philips.com

customers using or selling these products for use in such applications do so at their own risk and agree to fully indemnify Philips Semiconductors for any damages resulting from such application.

Right to make changes — Philips Semiconductors reserves the right to make changes in the products - including circuits, standard cells, and/or software - described or contained herein in order to improve design and/or performance. When the product is in full production (status 'Production'), relevant changes will be communicated via a Customer Product/Process Change Notification (CPCN). Philips Semiconductors assumes no responsibility or liability for the use of any of these products, conveys no license or title under any patent, copyright, or mask work right to these products, and makes no representations or warranties that these products are free from patent, copyright, or mask work right infringement, unless otherwise specified.

16. Trademarks

Notice — All referenced brands, product names, service names and trademarks are the property of their respective owners.

18. Contents

1	Product profile	1
1.1	General description	1
1.2	Features	1
1.3	Applications	1
1.4	Quick reference data	1
2	Pinning information	2
3	Ordering information	2
4	Marking	2
5	Limiting values	2
6	Thermal characteristics	4
7	Characteristics	6
8	Test information	11
9	Package outline	12
10	Packing information	12
11	Soldering	13
12	Revision history	14
13	Data sheet status	15
14	Definitions	15
15	Disclaimers	15
16	Trademarks	15
17	Contact information	15



© Koninklijke Philips Electronics N.V. 2005

All rights are reserved. Reproduction in whole or in part is prohibited without the prior written consent of the copyright owner. The information presented in this document does not form part of any quotation or contract, is believed to be accurate and reliable and may be changed without notice. No liability will be accepted by the publisher for any consequence of its use. Publication thereof does not convey nor imply any license under patent- or other industrial or intellectual property rights.

Date of release: 23 June 2005
Document ID: PBL2004D_1

Published in The Netherlands