

FEATURES

- Single Input, Triple Output Design
 - Three Video Tuner Outputs
- Wideband Operation: To Above 1 GHz
- 5 dB Typical Noise Figure at 5 dB Gain
- Extended Dynamic Range AGC Control, Independent for each Tuner Path
- High Linearity, Low Distortion
- Single +5 V Supply
- Balanced 75 Ohm Inputs/Outputs
- RoHS Compliant/Lead Free

APPLICATIONS

- CATV Set-Top Boxes with Multiple Tuners

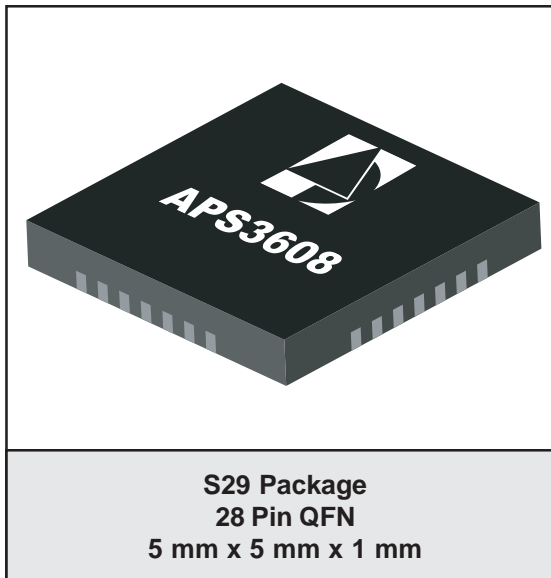

PRODUCT DESCRIPTION

This active splitter from ANADIGICS accepts a balanced RF input in the 50 MHz to 1.1 GHz frequency range and provides three balanced RF outputs with minimal degradation in signal quality. The single-package surface mount device amplifies the input signals using highly linear, low noise amplification stages, and couples the amplified signal to three separate output paths to drive video tuner inputs.

Each of the output paths includes independent Automatic Gain Control (AGC). The overall linearity

of each tuner path is maintained across a wide AGC range, ensuring low distortion effects on each output signal.

Requiring only a single +5 Volt supply, the active splitter design is implemented using the ANADIGICS GaAs MESFET process. The surface mount packaging makes the device ideal for use in today's multiple-tuner set-top boxes for Cable TV.

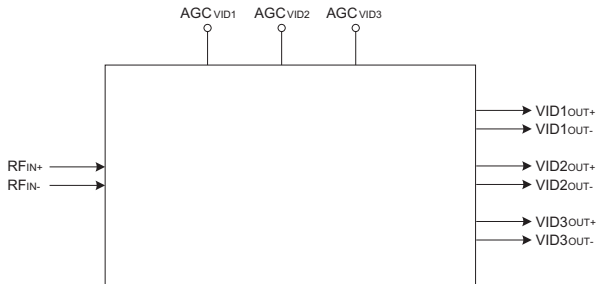

Figure 1: Functional Block Diagram

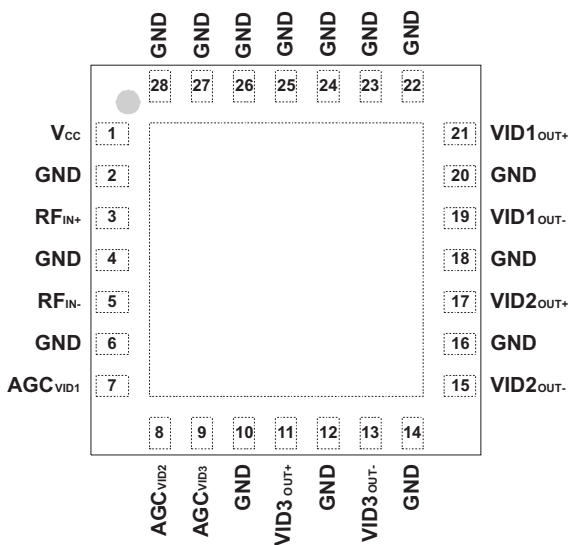

Figure 2: Pinout (X-ray Top View)

Table 1: Pin Description

PIN	NAME	DESCRIPTION	PIN	NAME	DESCRIPTION
1	V _{CC}	Supply Voltage	28	GND	Ground
2	GND	Ground	27	GND	Ground
3	RF _{IN+}	RF Input (+)	26	GND	Ground
4	GND	Ground	25	GND	Ground
5	RF _{IN-}	RF Input (-)	24	GND	Ground
6	GND	Ground	23	GND	Ground
7	AGC _{VID1}	Video 1 AGC Control Input	22	GND	Ground
8	AGC _{VID2}	Video 2 AGC Control Input	21	VID1 _{OUT+}	Video 1 Output (+)
9	AGC _{VID3}	Video 3 AGC Control Input	20	GND	Ground
10	GND	Ground	19	VID1 _{OUT-}	Video 1 Output (-)
11	VID3 _{OUT+}	Data Path Output (+)	18	GND	Ground
12	GND	Ground	17	VID2 _{OUT+}	Video 2 Output (+)
13	VID3 _{OUT-}	Data Path Output (-)	16	GND	Ground
14	GND	Ground	15	VID2 _{OUT-}	Video 2 Output (-)

ELECTRICAL CHARACTERISTICS

Table 2: Absolute Minimum and Maximum Ratings

PARAMETER	MIN	MAX	UNIT	COMMENTS
Supply Voltage (V_{CC})	0	+8	V	
AGC Input Voltage (V_{AGC})	0	+5	V	
RF Input Power (P_{IN})	-	+25	dBmV	differential into 75 Ω

Stresses in excess of the absolute ratings may cause permanent damage. Functional operation is not implied under these conditions. Exposure to absolute ratings for extended periods of time may adversely affect reliability.

Table 3: Operating Ranges

PARAMETER	MIN	TYP	MAX	UNIT	COMMENTS
Operating Frequency (f)	50	-	1100	MHz	
Supply Voltage (V_{CC})	-	+5	-	V	
AGC Input Voltage (V_{AGC})	+0.3	-	+3.0	V	max. gain at +3 V
RF Input Power (P_{IN})	-15	-	+15	dBmV	differential into 75 Ω
Case Temperature (T_C)	-20	-	+85	$^{\circ}$ C	

The device may be operated safely over these conditions; however, parametric performance is guaranteed only over the conditions defined in the electrical specifications.

Table 4: DC Electrical Specifications
(T_c = +25 °C, V_{cc} = +5 V, 75 Ω system)

PARAMETER	MIN	TYP	MAX	UNIT	COMMENTS
Current Consumption	-	175	-	mA	from +5 V supply
AGC Input Leakage Current	-	50	-	μA	each AGC input

Table 5: Video Tuner Path AC Electrical Specifications
(T_c = +25 °C, V_{cc} = +5 V, 75 Ω system)

PARAMETER	MIN	TYP	MAX	UNIT	COMMENTS
Gain at Maximum AGC	4.5	5.5	-	dB	at 1 GHz
Gain at Minimum AGC	-	-24	-	dB	at 1 GHz
AGC Range	28.0	29.5	-	dB	at 1 GHz
Noise Figure	-	4.8	6	dB	at maximum gain
CTB ⁽¹⁾	-	-70	-66	dBc	
CSO ⁽¹⁾	-	-70	-66	dBc	
XMOD ⁽¹⁾	-	-67	-	dBc	
Isolation Between Output and Any Other Output Port	-	30	-	dB	
Isolation Between Input and Output	-	30	-	dB	
Input Return Loss	-	-8	-	dB	75 Ω differential input
Output Impedance	-	75	-	Ω	differential

Notes:

(1) 132 channels, +6 dBmV flat output, up to +15 dBmV flat input

PERFORMANCE DATA

Figure 3: Gain vs. Frequency
($T_c = +25\text{ }^\circ\text{C}$, $V_{CC} = +5\text{ V}$)

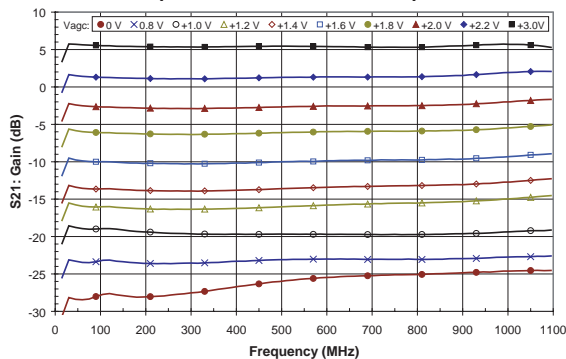

Figure 4: Input Return Loss vs. Frequency
($T_c = +25\text{ }^\circ\text{C}$, $V_{CC} = +5\text{ V}$)

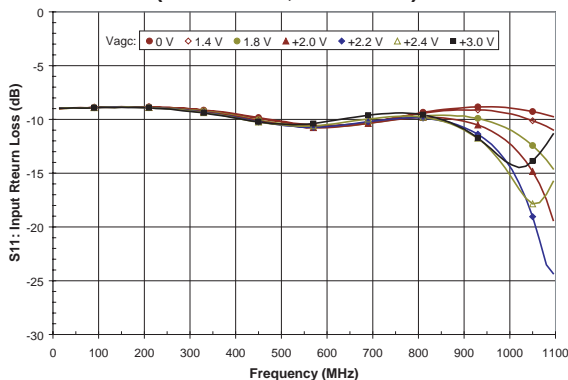

Figure 5: Output Return Loss vs. Frequency
($T_c = +25\text{ }^\circ\text{C}$, $V_{CC} = +5\text{ V}$)

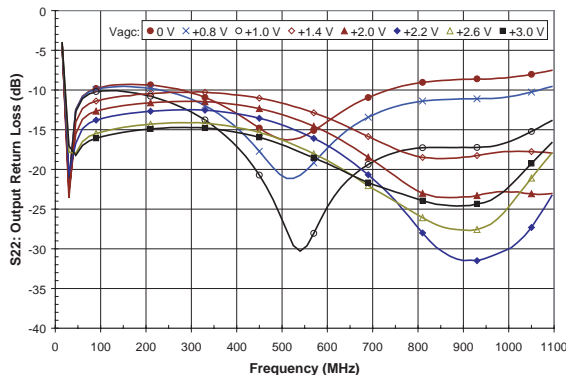

Figure 6: Reverse Isolation vs. Frequency
($T_c = +25\text{ }^\circ\text{C}$, $V_{CC} = +5\text{ V}$)

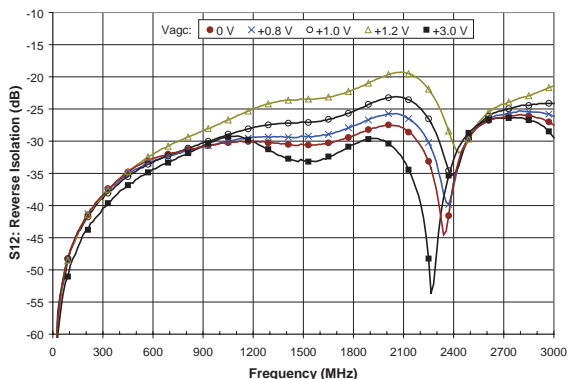

Figure 7: Noise Figure vs. Frequency
($T_c = +25\text{ }^\circ\text{C}$, $V_{CC} = +5\text{ V}$, $V_{AGC} = +3\text{ V}$)

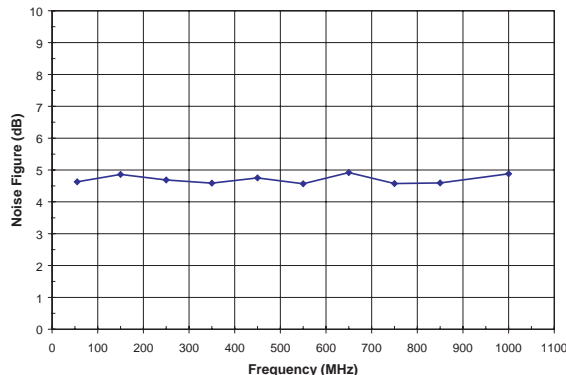

Figure 8: CSO vs. Input Power
 (T_C = +25 °C, V_{CC} = +5 V, f = 77 MHz,
 P_{OUT} = +6 dBmV, 135 channel flat input)

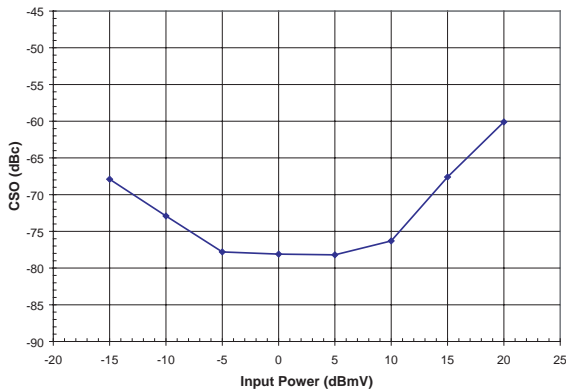

Figure 9: CTB vs. Input Power
 (T_C = +25 °C, V_{CC} = +5 V, f = 439 MHz,
 P_{OUT} = +6 dBmV, 135 channel flat input)

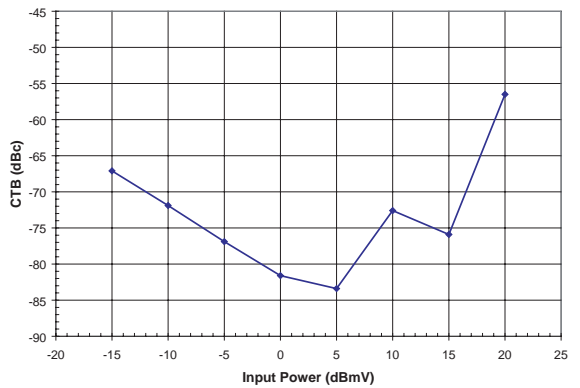

Figure 10: Output Port-to-Port Isolation vs. Frequency
 (T_C = +25 °C, V_{CC} = +5 V)

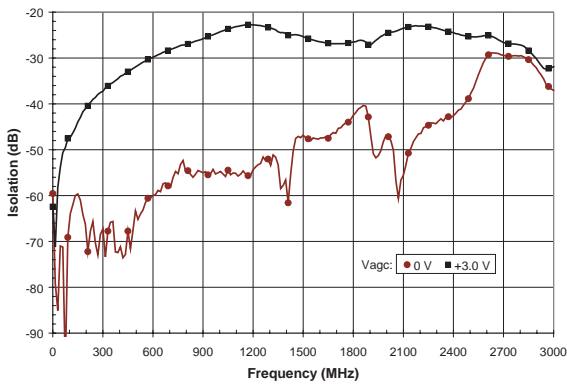
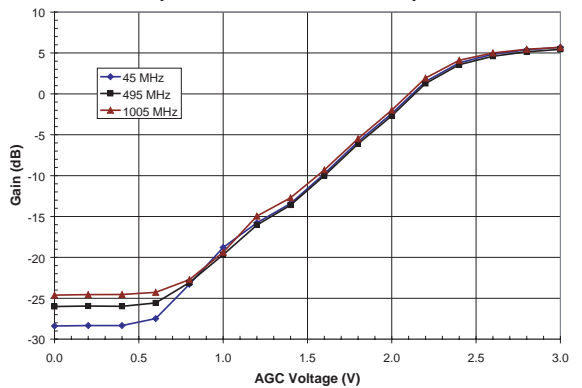
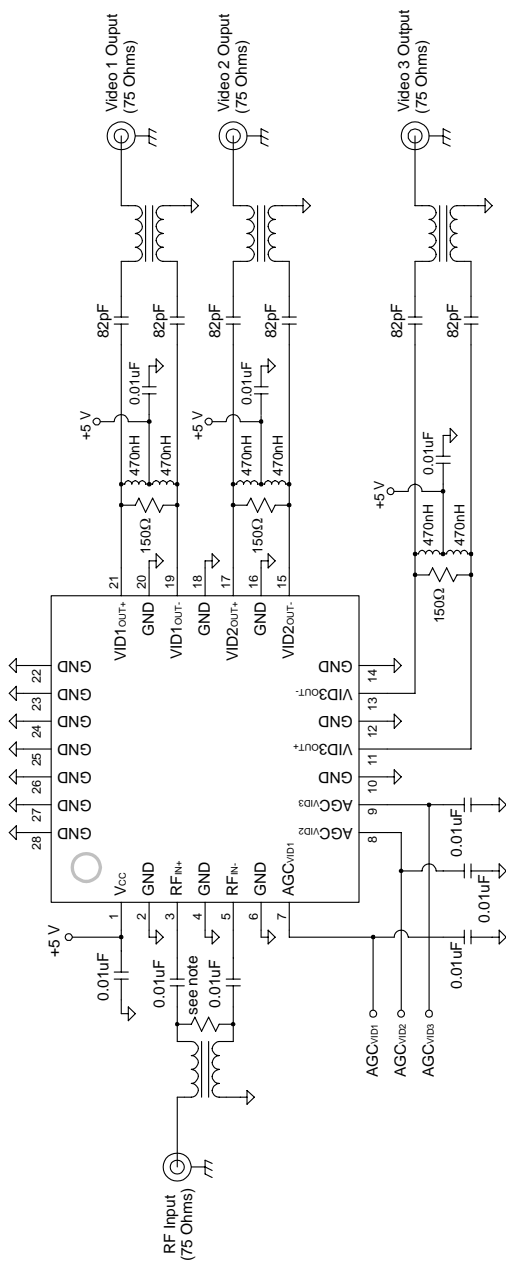

Figure 11: Gain vs. AGC Voltage
 (T_C = +25 °C, V_{CC} = +5 V)



APPLICATION INFORMATION



NOTE: Optional resistor across input pins may be used to tune input return loss.

Figure 12: Application Circuit

PACKAGE OUTLINE

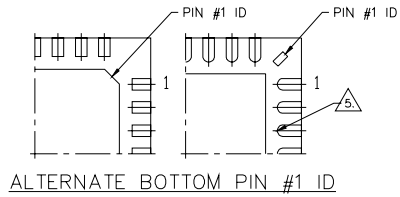
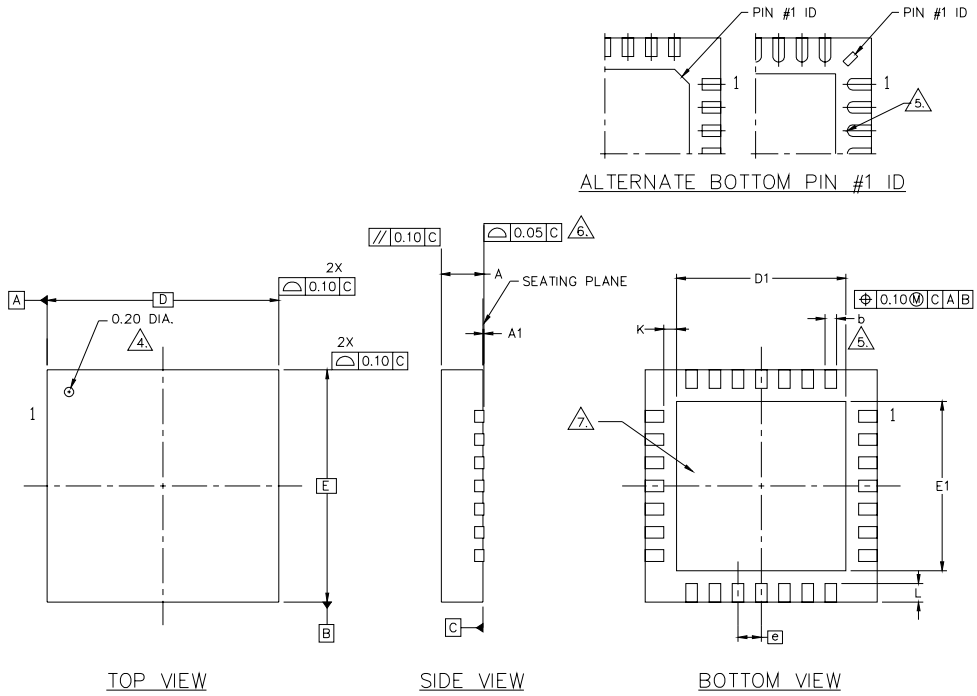

S V W G	DIMENSIONS—MM		N _o T _ε	S V W G	DIMENSIONS—INCHES		N _o T _ε
	MIN.	MAX.			MIN.	MAX.	
A	0.80	1.00	A	0.031	0.039		
A1	0.00	0.05	A1	0.000	0.002		
b	0.18	0.30	b	0.007	0.012		
D	5.00 BSC		D	0.197 BSC			
D1	3.40	3.80	D1	0.134	0.149		
E	5.00 BSC		E	0.197 BSC			
E1	3.40	3.80	E1	0.134	0.149		
⊕	0.50 BSC		⊕	0.020 BSC			
K	0.20 MIN.		K	0.007 MIN.			
L	0.35	0.57	L	0.014	0.022		

NOTES :

1. ALL DIMENSIONS ARE IN MILLIMETERS.
2. MAX. PACKAGE WARPAGE IS 0.05 mm.
3. MAXIMUM ALLOWABLE BURRS IS 0.076 mm IN ALL DIRECTIONS.
4. PIN #1 ID ON TOP WILL BE LASER MARKED.
5. DIMENSION b APPLIES TO METALLIZED TERMINAL AND IS MEASURED BETWEEN 0.25 AND 0.30mm FROM TERMINAL TIP. RADIUS OPTIONAL. DIMENSION b SHOULD NOT BE MEASURED IN RADIUS AREA.
6. BILATERAL COPLANARITY ZONE APPLIES TO THE EXPOSED HEAT SINK SLUG AS WELL AS THE TERMINALS.
7. REFERENCE JEDEC OUTLINE MO-220.

Figure 13: S29 Package Outline - 28 Pin 5 mm x 5 mm x 1 mm QFN

NOTES

NOTES

ORDERING INFORMATION

ORDER NUMBER	TEMPERATURE RANGE	PACKAGE DESCRIPTION	COMPONENT PACKAGING
APS3608RS29P8	-20 °C to +85 °C	RoHS Compliant 28 Pin 5 mm x 5 mm x 1 mm QFN Package	Tape and Reel, 2500 pieces per Reel



ANADIGICS, Inc.

141 Mount Bethel Road
Warren, New Jersey 07059, U.S.A.
Tel: +1 (908) 668-5000
Fax: +1 (908) 668-5132

URL: <http://www.anadigics.com>
E-mail: Mktg@anadigics.com

IMPORTANT NOTICE

ANADIGICS, Inc. reserves the right to make changes to its products or to discontinue any product at any time without notice. The product specifications contained in Advanced Product Information sheets and Preliminary Data Sheets are subject to change prior to a product's formal introduction. Information in Data Sheets have been carefully checked and are assumed to be reliable; however, ANADIGICS assumes no responsibilities for inaccuracies. ANADIGICS strongly urges customers to verify that the information they are using is current before placing orders.

WARNING

ANADIGICS products are not intended for use in life support appliances, devices or systems. Use of an ANADIGICS product in any such application without written consent is prohibited.