

F100155

Quad Multiplexer/Latch

General Description

The F100155 contains four transparent latches, each of which can accept and store data from two sources. When both Enable (\bar{E}_n) inputs are LOW, the data that appears at an output is controlled by the Select (S_n) inputs, as shown in the Operating Mode table. In addition to routing data from either D_0 or D_1 , the Select inputs can force the outputs LOW for the case where the latch is transparent (both Enables are LOW) and can steer a HIGH signal from either D_0 or D_1 to an output. The Select inputs can be tied together for applications requiring only that data be steered from ei-

ther D_0 or D_1 . A positive-going signal on either Enable input latches the outputs. A HIGH signal on the Master Reset (MR) input overrides all the other inputs and forces the Q outputs LOW. All inputs have 50 k Ω pulldown resistors.

Refer to the F100355 datasheet for:

- PCC packaging
- Lower power
- Military versions
- Extended voltage specs (-4.2V to -5.7V)

Ordering Code: See Section 8

Logic Symbol

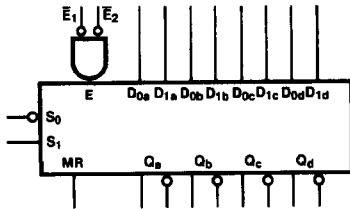

TL/F/9860-3

Pin Names	Description
\bar{E}_1, \bar{E}_2	Enable Inputs (Active LOW)
\bar{S}_0, S_1	Select Inputs
MR	Master Reset
$D_{na}-D_{nd}$	Data Inputs
Q_a-Q_d	Data Outputs
$\bar{Q}_a-\bar{Q}_d$	Complementary Data Outputs

Connection Diagrams

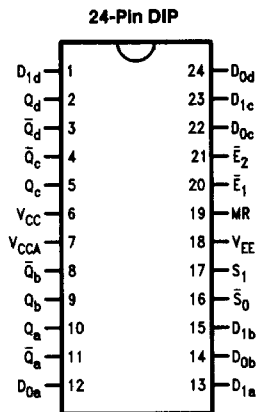

TL/F/9860-1

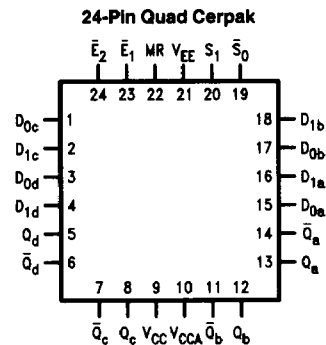

TL/F/9860-2

Logic Diagram

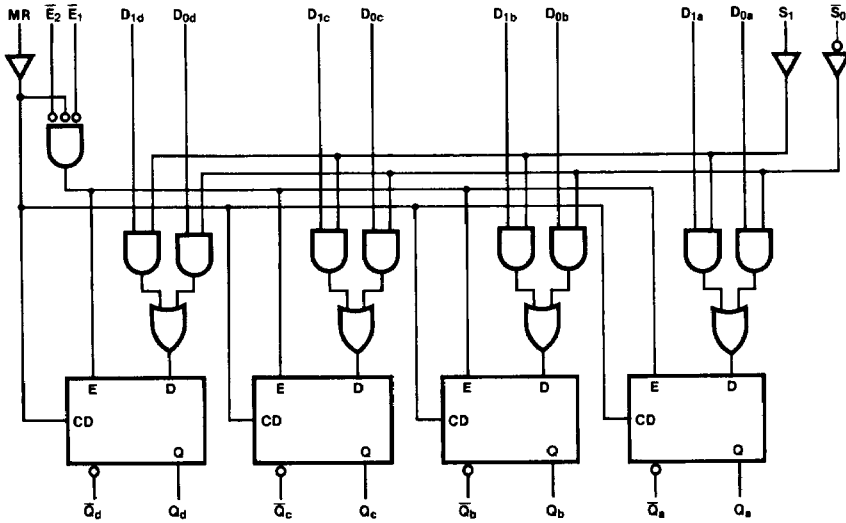

TL/F/9860-5

Operating Mode Table

Controls				Outputs
\bar{E}_1	\bar{E}_2	S_1	\bar{S}_0	Q_n
H	X	X	X	Latched*
X	H	X	X	Latched*
L	L	L	L	D_{0x}
L	L	H	L	$D_{0x} + D_{1x}$
L	L	L	H	L
L	L	H	H	D_{1x}

*Stores data present before \bar{E} went HIGH
 H = HIGH Voltage Level
 L = LOW Voltage Level
 X = Don't Care

Truth Table

MR	Inputs					Outputs		
	\bar{E}_1	\bar{E}_2	S_1	\bar{S}_0	D_{1x}	D_{0x}	\bar{Q}_x	Q_x
H	X	X	X	X	X	X	H	L
L	L	L	H	H	H	X	L	H
L	L	L	H	H	L	X	H	L
L	L	L	L	L	X	H	L	H
L	L	L	L	L	X	L	H	L
L	L	L	L	H	X	X	H	L
L	L	L	H	L	H	X	L	H
L	L	L	H	L	X	H	L	H
L	L	L	H	L	L	L	H	L
L	H	X	X	X	X	X	Latched*	Latched*
L	X	H	X	X	X	X	Latched*	Latched*

Absolute Maximum Ratings

Above which the useful life may be impaired. (Note 1)

If Military/Aerospace specified devices are required, please contact the National Semiconductor Sales Office/Distributors for availability and specifications.

Storage Temperature -65°C to $+150^{\circ}\text{C}$

Maximum Junction Temperature (T_J) $+150^{\circ}\text{C}$

Case Temperature under Bias (T_C) 0°C to $+85^{\circ}\text{C}$

V_{EE} Pin Potential to Ground Pin -7.0V to $+0.5\text{V}$

Input Voltage (DC) V_{EE} to $+0.5\text{V}$

Output Current (DC Output HIGH) -50mA

Operating Range (Note 2) -5.0V to -4.2V

DC Electrical Characteristics

$V_{EE} = -4.5\text{V}$, $V_{CC} = V_{CCA} = \text{GND}$, $T_C = 0^{\circ}\text{C}$ to $+85^{\circ}\text{C}$ (Note 3)

Symbol	Parameter	Min	Typ	Max	Units	Conditions (Note 4)	
V_{OH}	Output HIGH Voltage	-1025	-955	-880	mV	$V_{IN} = V_{IH}(\text{Max})$ or $V_{IL}(\text{Min})$	Loading with 50Ω to -2.0V
V_{OL}	Output LOW Voltage	-1810	-1705	-1620			
V_{OHC}	Output HIGH Voltage	-1035			mV	$V_{IN} = V_{IH}(\text{Min})$ or $V_{IL}(\text{Max})$	Loading with 50Ω to -2.0V
V_{OLC}	Output LOW Voltage			-1610			
V_{IH}	Input HIGH Voltage	-1165		-880	mV	Guaranteed HIGH Signal for All Inputs	
V_{IL}	Input LOW Voltage	-1810		-1475	mV	Guaranteed LOW Signal for All Inputs	
I_{IL}	Input LOW Current	0.50			μA	$V_{IN} = V_{IL}(\text{Min})$	

DC Electrical Characteristics

$V_{EE} = -4.2\text{V}$, $V_{CC} = V_{CCA} = \text{GND}$, $T_C = 0^{\circ}\text{C}$ to $+85^{\circ}\text{C}$ (Note 3)

Symbol	Parameter	Min	Typ	Max	Units	Conditions (Note 4)	
V_{OH}	Output HIGH Voltage	-1020		-870	mV	$V_{IN} = V_{IH}(\text{Max})$ or $V_{IL}(\text{Min})$	Loading with 50Ω to -2.0V
V_{OL}	Output LOW Voltage	-1810		-1605			
V_{OHC}	Output HIGH Voltage	-1030			mV	$V_{IN} = V_{IH}(\text{Min})$ or $V_{IL}(\text{Max})$	Loading with 50Ω to -2.0V
V_{OLC}	Output LOW Voltage			-1595			
V_{IH}	Input HIGH Voltage	-1150		-870	mV	Guaranteed HIGH Signal for All Inputs	
V_{IL}	Input LOW Voltage	-1810		-1475	mV	Guaranteed LOW Signal for All Inputs	
I_{IL}	Input LOW Current	0.50			μA	$V_{IN} = V_{IL}(\text{Min})$	

DC Electrical Characteristics

$V_{EE} = -4.8\text{V}$, $V_{CC} = V_{CCA} = \text{GND}$, $T_C = 0^{\circ}\text{C}$ to $+85^{\circ}\text{C}$ (Note 3)

Symbol	Parameter	Min	Typ	Max	Units	Conditions (Note 4)	
V_{OH}	Output HIGH Voltage	-1035		-880	mV	$V_{IN} = V_{IH}(\text{Max})$ or $V_{IL}(\text{Min})$	Loading with 50Ω to -2.0V
V_{OL}	Output LOW Voltage	-1830		-1620			
V_{OHC}	Output HIGH Voltage	-1045			mV	$V_{IN} = V_{IH}(\text{Min})$ or $V_{IL}(\text{Max})$	Loading with 50Ω to -2.0V
V_{OLC}	Output LOW Voltage			-1610			
V_{IH}	Input HIGH Voltage	-1165		-880	mV	Guaranteed HIGH Signal for All Inputs	
V_{IL}	Input LOW Voltage	-1830		-1490	mV	Guaranteed LOW Signal for All Inputs	
I_{IL}	Input LOW Current	0.50			μA	$V_{IN} = V_{IL}(\text{Min})$	

Note 1: Absolute maximum ratings are those values beyond which the device may be damaged or have its useful life impaired. Functional operation under these conditions is not implied.

Note 2: Parametric values specified at -4.2V to -4.8V .

Note 3: The specified limits represent the "worst case" value for the parameter. Since these "worst case" values normally occur at the temperature extremes, additional noise immunity and guard banding can be achieved by decreasing the allowable system operating ranges.

Note 4: Conditions for testing shown in the tables are chosen to guarantee operation under "worst case" conditions.

DC Electrical Characteristics $V_{EE} = -4.2V$ to $-4.8V$ unless otherwise specified, $V_{CC} = V_{CCA} = GND$, $T_C = 0^\circ C$ to $+85^\circ C$

Symbol	Parameter	Min	Typ	Max	Units	Conditions
I_{IH}	Input HIGH Current S_0, S_1 \bar{E}_1, \bar{E}_2 $D_{na}-D_{nd}$ MR			220 350 340 430	μA	$V_{IN} = V_{IH}(\text{Max})$
I_{EE}	Power Supply Current	-133	-95	-66	mA	Inputs Open

Ceramic Dual-In-Line Package AC Electrical Characteristic $V_{EE} = -4.2V$ to $-4.8V$, $V_{CC} = V_{CCA} = GND$

Symbol	Parameter	$T_C = 0^\circ C$		$T_C = +25^\circ C$		$T_C = +85^\circ C$		Units	Conditions
		Min	Max	Min	Max	Min	Max		
t_{PLH} t_{PHL}	Propagation Delay $D_{na}-D_{nd}$ to Output (Transparent Mode)	0.50	1.90	0.60	1.85	0.50	1.90	ns	Figures 1 and 2
t_{PLH} t_{PHL}	Propagation Delay \bar{S}_0, S_1 to Output (Transparent Mode)	1.50	3.50	1.50	3.40	1.50	3.50	ns	
t_{PLH} t_{PHL}	Propagation Delay \bar{E}_1, \bar{E}_2 to Output	0.90	2.50	1.00	2.40	1.00	2.50	ns	
t_{PLH} t_{PHL}	Propagation Delay MR to Output	0.90	3.00	0.90	2.90	0.90	3.00	ns	Figures 1 and 3
t_{TLH} t_{THL}	Transition Time 20% to 80%, 80% to 20%	0.60	2.30	0.60	2.20	0.45	2.30	ns	Figures 1 and 2
t_s	Setup Time $D_{na}-D_{nd}$ \bar{S}_0, S_1 MR (Release Time)	0.90 2.40 1.50		0.90 2.40 1.50		0.90 2.70 1.50		ns	Figure 4 Figure 3
t_H	Hold Time $D_{na}-D_{nd}$ \bar{S}_0, S_1	0.40 -0.70		0.40 -0.70		0.40 -0.70		ns	Figure 4
$t_{pw}(L)$	Pulse Width LOW \bar{E}_1, \bar{E}_2	2.00		2.00		2.00		ns	Figure 2
$t_{pw}(H)$	Pulse Width HIGH MR	2.00		2.00		2.00		ns	Figure 3

Cerpak AC Electrical Characteristics $V_{EE} = -4.2V$ to $-4.8V$, $V_{CC} = V_{CCA} = GND$

Symbol	Parameter	$T_C = 0^\circ C$		$T_C = +25^\circ C$		$T_C = +85^\circ C$		Units	Conditions
		Min	Max	Min	Max	Min	Max		
t_{PLH} t_{PHL}	Propagation Delay $D_{na}-D_{nd}$ to Output (Transparent Mode)	0.50	1.70	0.60	1.65	0.50	1.70	ns	Figures 1 and 2
t_{PLH} t_{PHL}	Propagation Delay \bar{S}_1, S_1 to Output (Transparent Mode)	1.50	3.30	1.50	3.20	1.50	3.30	ns	
t_{PLH} t_{PHL}	Propagation Delay \bar{E}_1, \bar{E}_2 to Output	0.90	2.30	1.00	2.20	1.00	2.30	ns	

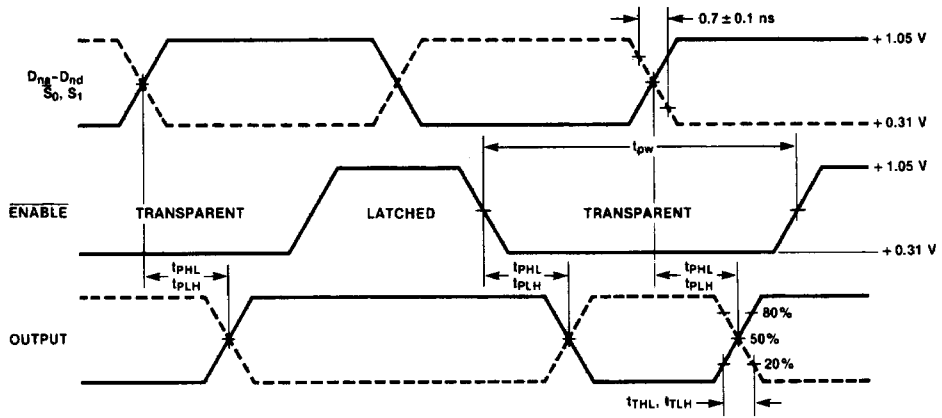

FIGURE 2. Enable Timing

TL/F/9860-7

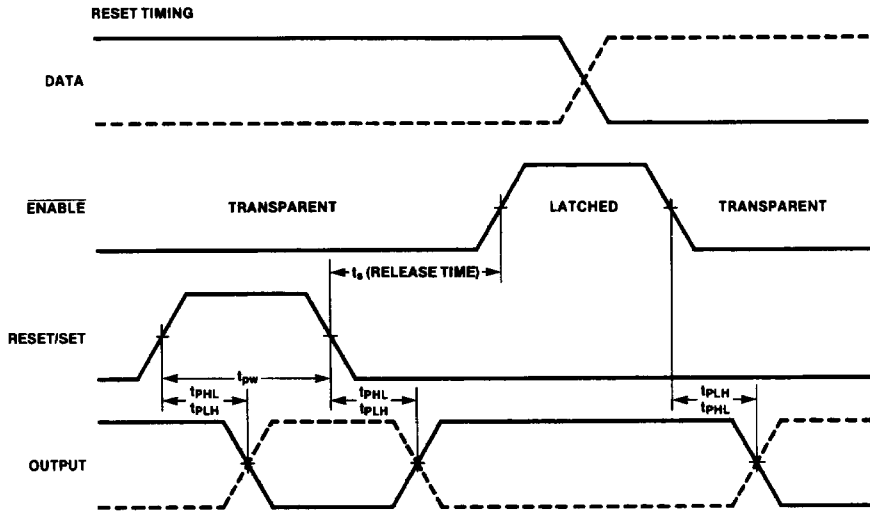

FIGURE 3. Reset Timing

TL/F/9860-8

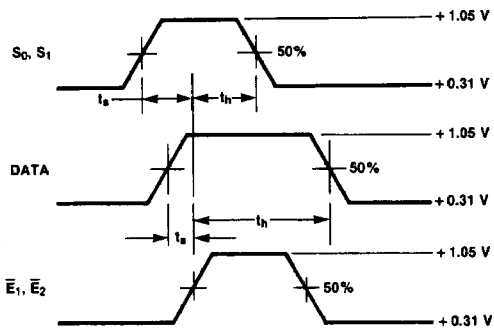

FIGURE 4. Data Setup and Hold Times

TL/F/9860-9

Notes:

- t_s is the minimum time before the transition of the enable that information must be present at the data input.
- t_h is the minimum time after the transition of the enable that information must remain unchanged at the data input.