

General Description

The MIC5202 is a dual linear voltage regulator with low dropout voltage (typically 17mV at light loads and 210mV at 100mA), and low ground current (1mA at 100mA per output). Ideal for battery-operated applications, the MIC5202 offers 1% output voltage accuracy and dual enable pins. The enable pins may be driven individually or tied directly to V_{IN} . When the part is disabled, power consumption drops to nearly zero. The MIC5202 ground current increases slightly in dropout, which minimizes power consumption and increases battery life. Some key features include reversed battery protection, current limit, and overtemperature protection.

The MIC5202 is available in fixed output voltages in the small 8-pin SOIC package.

Datasheets and support documentation are available on Micrel's web site at: www.micrel.com.

Features

- High output voltage accuracy
- Variety of output voltages
- Up to 100mA of continuous output current
- Low ground current
- Low dropout voltage
- Excellent line and load regulations
- Extremely low temperature coefficient
- Current and thermal limit protections
- Reverse-battery protection
- Zero-off mode current
- Logic-controlled electronic shutdown
- 8-Pin SOIC package

Applications

- Cell phones
- Laptop, notebook, and palmtop computers
- Battery-powered equipment
- PCMCIA VCC and VPP regulation/switching
- Bar code scanners
- SMPS post-regulator/ DC to DC modules
- High-efficiency linear power supplies

Typical Application

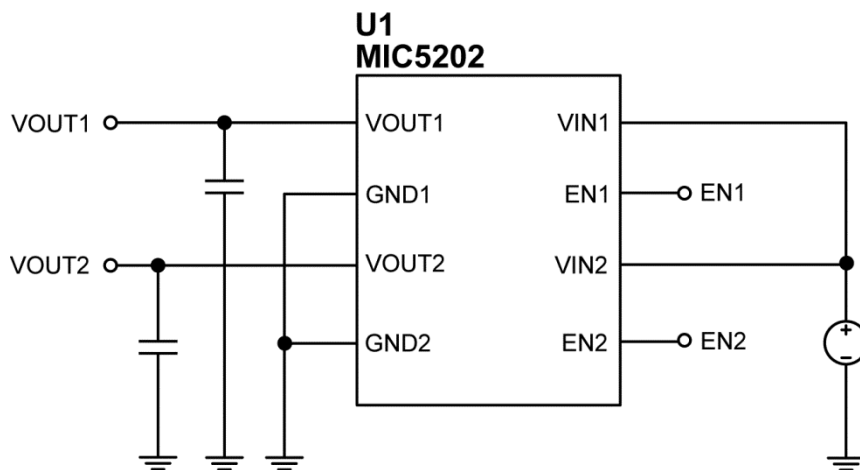

Ordering Information

Part Number ⁽¹⁾	Marking	VOUT1	VOUT2	Accuracy	Junction Temperature Range	Package
MIC5202-3.0YM	30YM	3V	3V	1%	-40°C to +125°C	8-Pin SOIC
MIC5202-3.3YM	33YM	3.3V	3.3V	1%	-40°C to +125°C	8-Pin SOIC
MIC5202-4.8YM	48YM	4.85V	4.85V	1%	-40°C to +125°C	8-Pin SOIC
MIC5202-5.0YM	50YM	5V	5V	1%	-40°C to +125°C	8-Pin SOIC

Note:

1. Other voltages are available. Contact Micrel for details.

Pin Configuration

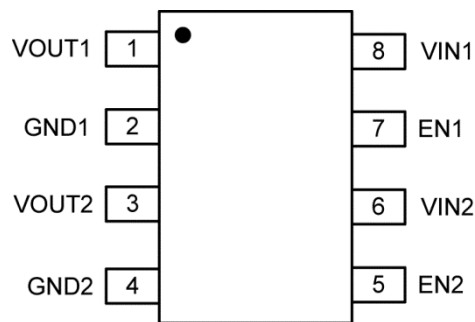

8-Pin SOIC (M)
(Top View)

Pin Description

Pin Number	Pin Name	Pin Function
1	VOUT1	Output of regulator 1.
2	GND1	Ground pin of LDO1.
3	VOUT2	Output of regulator 2.
4	GND2	Ground pin of LDO2.
5	EN2	Enable input for LDO2. Active-high Input. Logic high = On, logic low = Off. Do not leave floating.
6	VIN2	Voltage input for LDO2.
7	EN1	Enable input for LDO1. Active-high Input. Logic high = On, logic low = Off. Do not leave floating.
8	VIN1	Voltage input for LDO1.

Absolute Maximum Ratings⁽²⁾

Input Supply Voltage (VIN1, VIN2)..... –20V to +60V
 Enable Input Voltage (EN1, EN2) –20V to +60V
 Lead Temperature (soldering, 10s)..... 260°C
 Storage Temperature (Ts)..... –65°C to +150°C
 ESD Rating⁽⁴⁾..... ESD Sensitive

Operating Ratings⁽³⁾

Input Supply Voltage (VIN1, VIN2) +2.5V to +26V
 Enable Input Voltage (EN1, EN2) 0V to VIN
 Junction Temperature (TJ) –40°C to 125°C
 Junction Thermal Resistance
 SOIC (θJA) 63°C/W

Electrical Characteristics⁽⁵⁾

VIN = VOUT + 1V; COUT = 10μF; IOUT = 1mA; TJ = 25°C, **bold** values indicate –40°C ≤ TJ ≤ +125°C, unless otherwise noted.
 Specifications are for one LDO.

Symbol	Parameter	Condition	Min.	Typ.	Max.	Units
VOUT	Output Voltage Accuracy		–1 –2		1 2	%
ΔVOUT/ΔT	Output Voltage Temperature Coefficient ⁽⁶⁾			40	150	ppm/°C
ΔVOUT/VOUT	Line Regulation	VIN = VOUT + 1V to 26V		0.004	0.10 0.40	%
ΔVOUT/VOUT	Load Regulation ⁽⁷⁾	IOUT = 0.1mA to 100mA		0.04	0.16 0.30	%
VIN – VOUT	Dropout Voltage ⁽⁸⁾	IOUT = 100μA IOUT = 20mA IOUT = 30mA IOUT = 50mA IOUT = 100mA		17 130 150 180 225	350	mV
ISHUTDOWN	Ground Pin Current in Shutdown	VEN ≤ 0.7V (shutdown)		0.01		μA
IGND	Ground Pin Current ⁽⁹⁾	VEN ≥ 2.0V, IOUT = 100μA IOUT = 20mA IOUT = 30mA IOUT = 50mA IOUT = 100mA I		170 270 330 500 1200	1500	μA

Notes:

- Exceeding the absolute maximum ratings may damage the device.
- The device is not guaranteed to function outside its operating ratings.
- Devices are ESD sensitive. Handling precautions are recommended. Human body model, 1.5kΩ in series with 100pF.
- Specification for packaged product only.
- Output voltage temperature coefficient is defined as the worst case voltage change divided by the temperature range.
- Load regulation is measured at a constant junction temperature using low duty cycle pulse testing. Parts are tested for load regulation in the load range from 0.1mA to 100mA. Changes in output voltage caused by heating effects are covered by the thermal regulation specification.
- Dropout voltage is defined as the input to output differential at which the output voltage drops 2% below its nominal value measured at 1V differential.
- Ground pin current is the regulator quiescent current plus pass transistor base current. The total current drawn from the supply is the sum of the load current plus the ground pin current.

Electrical Characteristics⁽⁵⁾ (Continued)

$V_{IN} = V_{OUT} + 1V$; $C_{OUT} = 10\mu F$; $I_{OUT} = 1mA$; $T_J = 25^\circ C$, **bold** values indicate $-40^\circ C \leq T_J \leq +125^\circ C$, unless otherwise noted. Specifications are for one LDO.

Symbol	Parameter	Condition	Min.	Typ.	Max.	Units
I_{GNDDO}	Ground Pin Current in Dropout	$V_{IN} = 0.5V$ less than V_{OUT} , $I_{OUT} = 100\mu A$		270	330	μA
PSRR	Power Supply Rejection Ratio			75		dB
I_{LIMIT}	Short Circuit Current Limit	$V_{OUT} = 0V$		280		mA
$\Delta V_{OUT}/\Delta P_D$	Thermal Regulation ⁽¹⁰⁾			0.05		%/W
e_n	Output Noise			100		μV
Enable Input						
V_{EN}	Enable Input Voltage	Logic low = Off Logic high = On	2.0		0.7	V
I_{ENL} I_{ENH}	Enable Input Current	$V_{EN} \leq 0.7V$ $V_{EN} \geq 2.0V$		0.01 8	50	μA

Note:

10. Thermal regulation is defined as the change in output voltage at a time "t" after a change in power dissipation is applied, excluding load or line regulation effects. Specifications are for a 100mA load pulse at $V_{IN} = 26V$ for $t = 10ms$.

Typical Characteristics

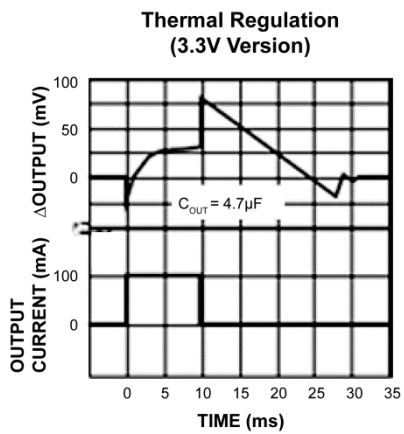
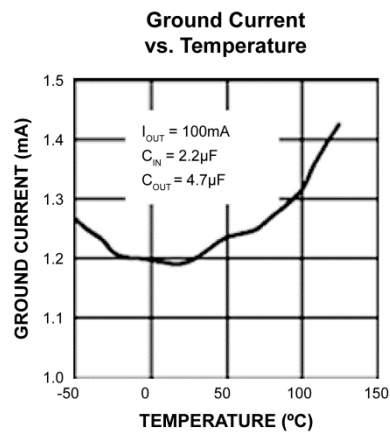
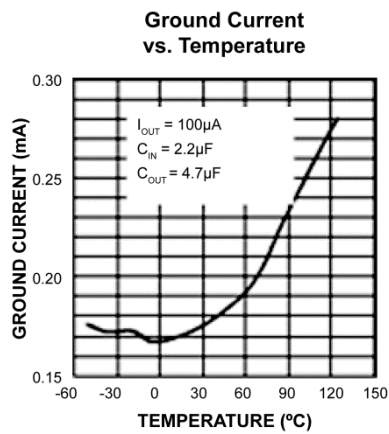
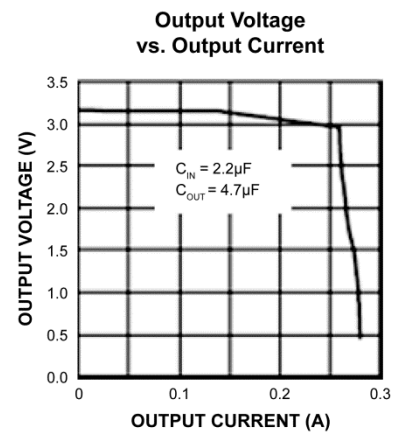
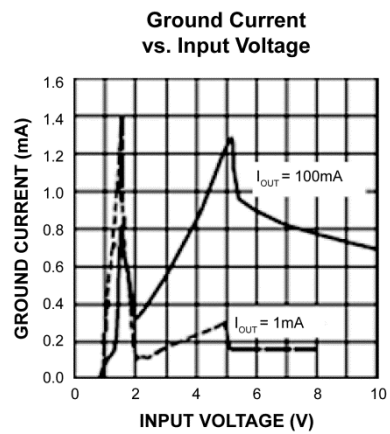
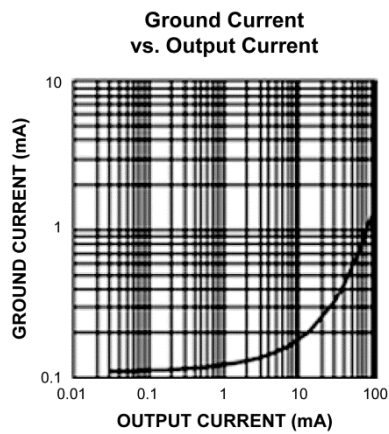
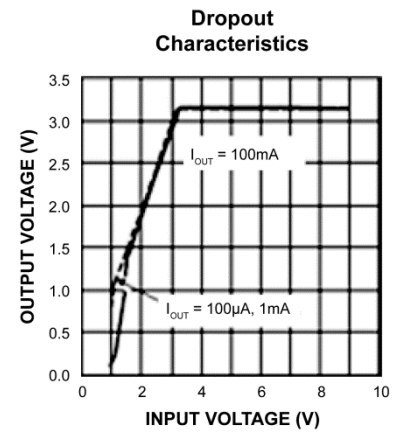
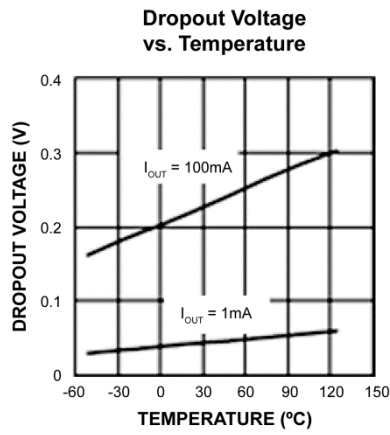
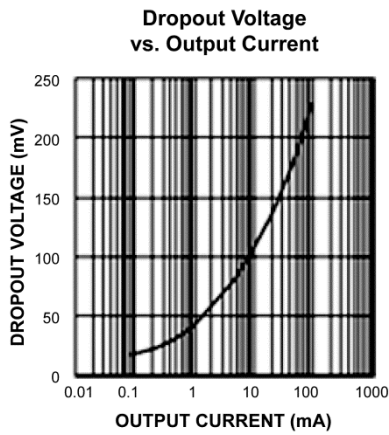

Typical Characteristics (Continued)

**Output Voltage vs. Temperature
(3.3V Version)**

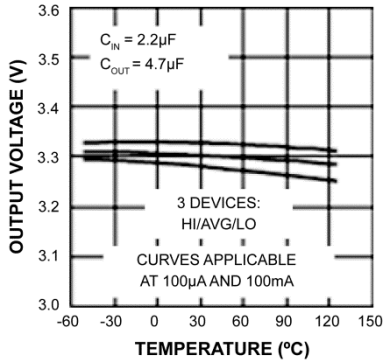

Output Current vs. Temperature

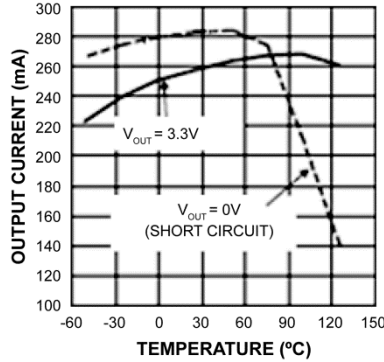

Minimum Input Voltage vs. Temperature

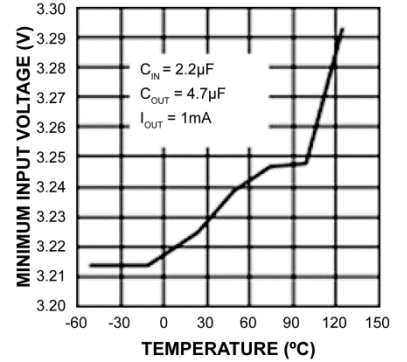

Short Circuit Current vs. Input Voltage

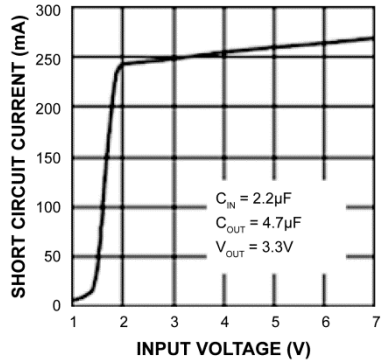

Load Transient

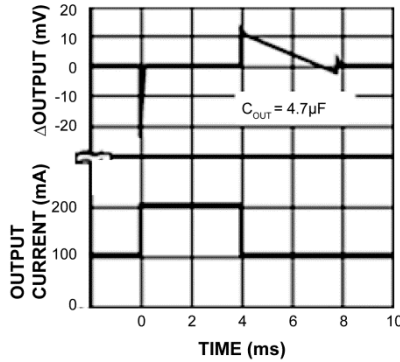

Load Transient

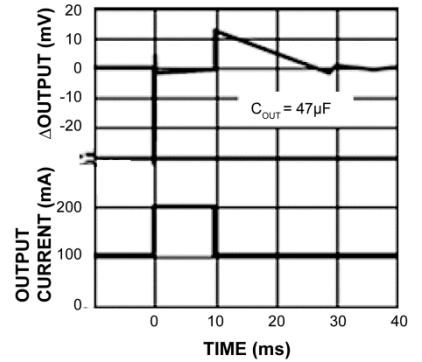

Input Current vs. Input Voltage (3.3V Version)

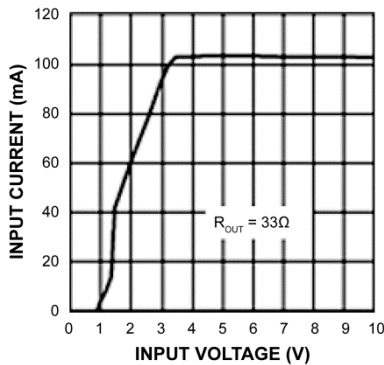

Line Transient

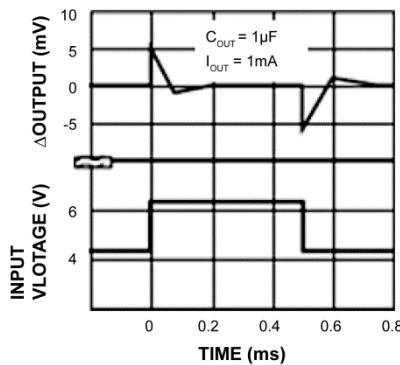

Line Transient

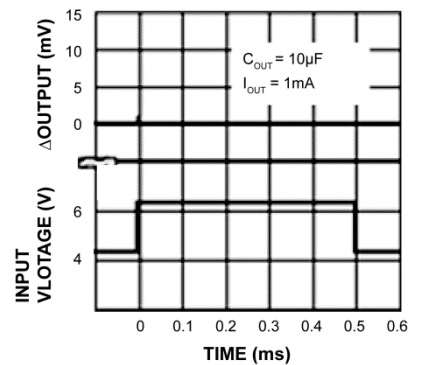

Typical Characteristics (Continued)

Input Current vs. Input Voltage (3.3V Version)

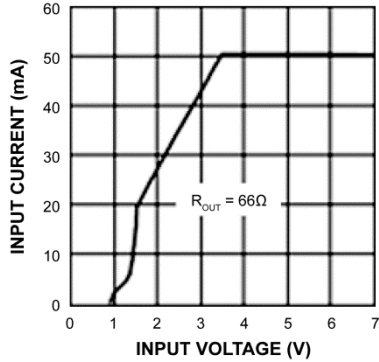

Enable Transient (3.3V Version)

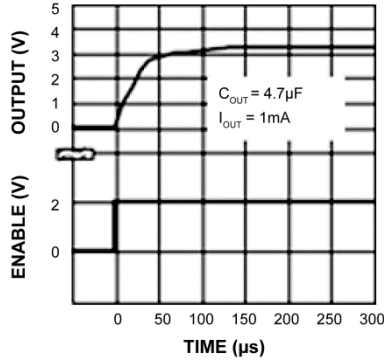

Enable Transient (3.3V Version)

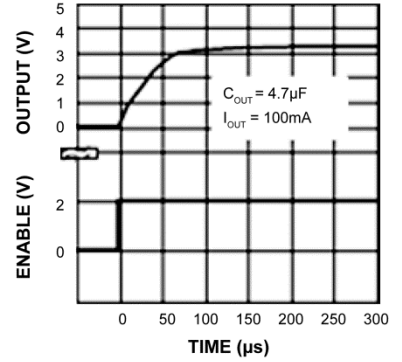

Output Impedance

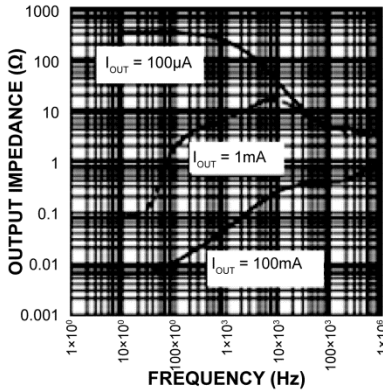

Enable Current Threshold vs. Temperature

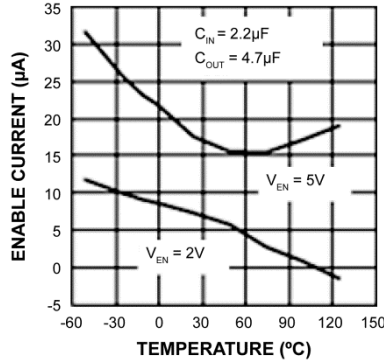

Enable Voltage Threshold vs. Temperature

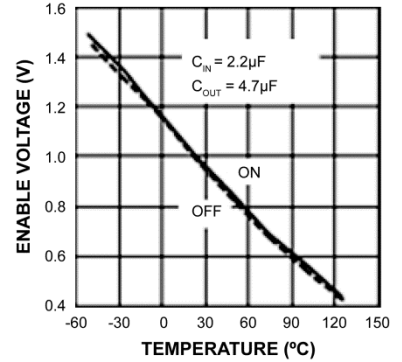

Ripple vs. Frequency

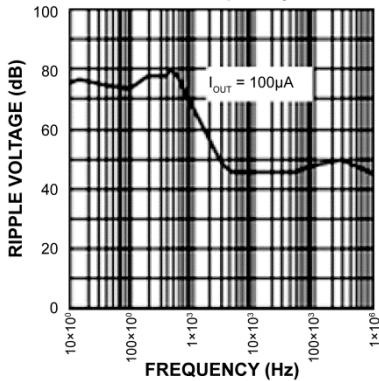

Ripple vs. Frequency

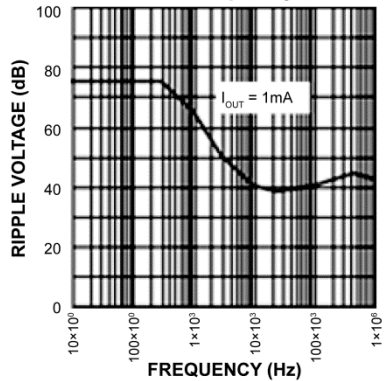

Ripple vs. Frequency

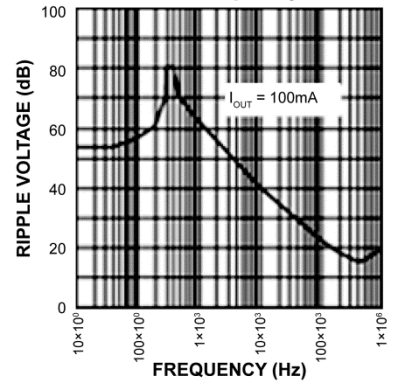

Application Information

The MIC5202 is a dual linear voltage regulator with low dropout voltage and low ground current features. Ideal for battery operated applications, the MIC5202 offers 1% output voltage accuracy, two independent enable pins, reversed battery protection, short circuit current limit and overtemperature protection. When the MIC5202 is disabled, the ground pin current drops to sub-micro amp and prolongs the battery life.

Input Supply Voltage

VIN1 and VIN2 provide power to each internal circuit and may be tied together.

Ground

Both ground pins (pin 2 and 4) must be tied to the same ground potential when using a single power supply.

Input Capacitor

A 1 μ F tantalum or aluminum electrolytic capacitor should be placed close to each VIN pin if there is more than 10 inches of copper between the input and the capacitor, or if a battery is used as the supply.

Output Capacitor

The MIC5202 requires an output capacitor of 1 μ F or greater to maintain stability. Increasing the output capacitor leads to an improved transient response; however, the size and cost also increase. Most tantalum and aluminum electrolytic capacitors are adequate; film capacitors will work as well, but at a higher cost. Many aluminum electrolytics have electrolytes that freeze at –

30°C, so tantalum capacitors are recommended for operations below –25°C. An equivalent series resistance (ESR) of 5 Ω or less with a resonance frequency above 500 kHz is recommended. The output capacitor value may be increased without limit.

At lower output loads, a smaller output capacitor value is required for output stability. The capacitor can be reduced to 0.47 μ F for current below 10mA or 0.33 μ F for current below 1mA.

No-Load Stability

Unlike many other voltage regulators, the MIC5202 remains stable and in regulation with no load. This is especially important in CMOS RAM keep-alive applications.

Enable Input

The MIC5202 features dual active-high enable pins that allow each regulator to be enabled and disabled independently. Forcing the enable pin low disables the regulator and sends it to a “zero” off-mode-current state. In this state, current consumed by the regulator goes nearly to zero. Forcing the enable pin high enables the output voltage. The active-high enable pin typically consumes 8 μ A of current and cannot be left floating; a floating enable pin may cause an indeterminate state on the output.

Thermal Shutdown

When the internal die temperature of MIC5202 reaches the limit, the internal driver is disabled until the die temperature falls.

Thermal Considerations

Part I. Layout

The MIC5202 (8-pin SOIC package) has the thermal characteristics shown in [Table 1](#), when mounted on a single-layer copper-clad printed circuit board.

Table 1. Thermal Characteristic Consideration

PC Board Dielectric	θ_{JA}
FR4	160°C/W
Ceramic	120°C/W

Multi-layer boards with a dedicated ground plane, wide traces, and large supply bus lines provide better thermal conductivity.

The “worst case” value of 160°C/W assumes no ground plane, minimum trace widths, and a FR4 material board.

Part II. Nominal Power Dissipation and Die Temperature

At 25°C ambient temperature, the MIC5202 operates reliably at up to 625mW when mounted in the “worst case” manner described in [Part I. Layout](#). At an ambient temperature of 55°C, the device can safely dissipate 440mW. These power levels are equivalent to a die temperature of 125°C, which corresponds to the recommended maximum temperature for non-military grade silicon integrated circuits.

Package Information⁽¹¹⁾ and Recommended Landing Pattern

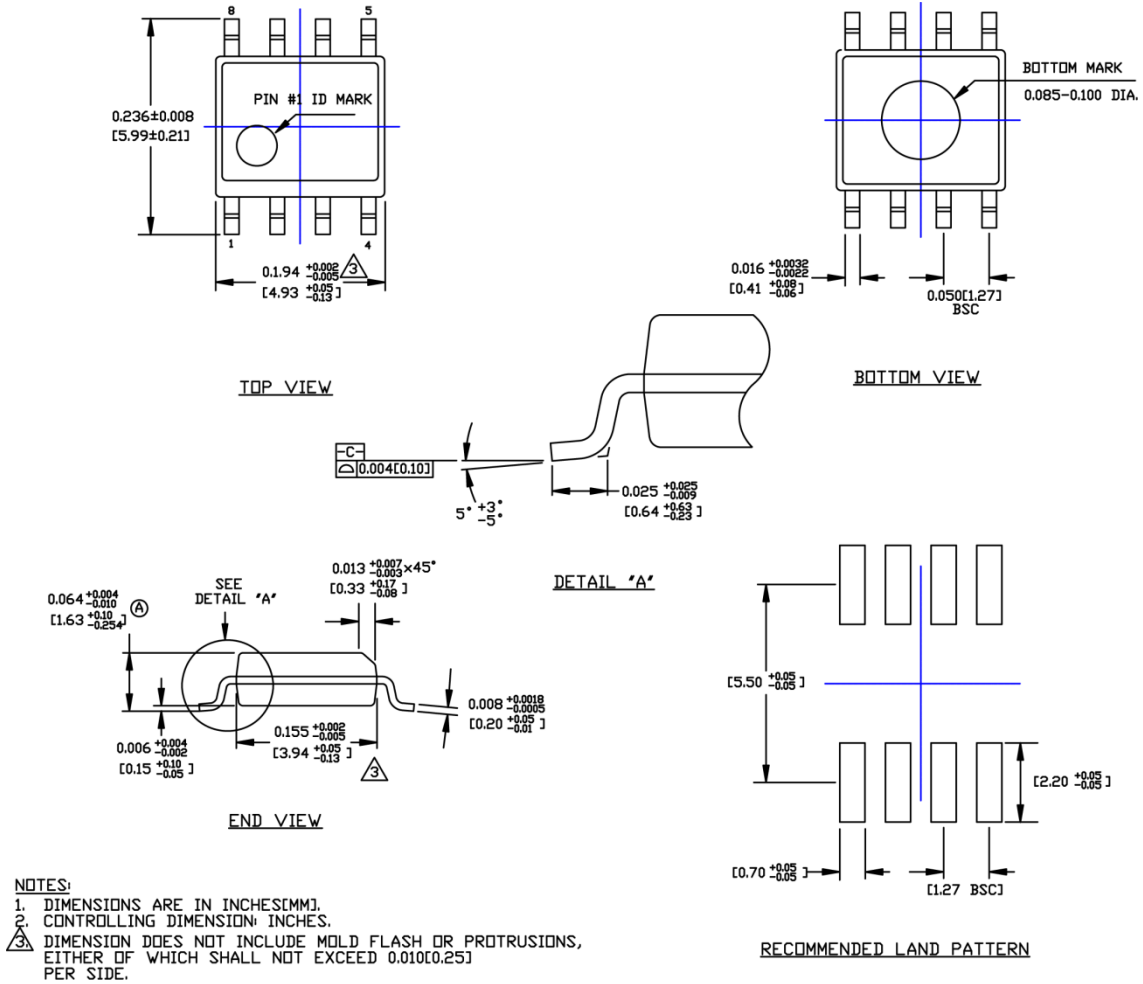

8-Pin SOIC Package (M)

Note:

11. Package information is correct as of the publication date. For updates and most current information, go to www.micrel.com.

MICREL, INC. 2180 FORTUNE DRIVE SAN JOSE, CA 95131 USA
 TEL +1 (408) 944-0800 FAX +1 (408) 474-1000 WEB <http://www.micrel.com>

Micrel makes no representations or warranties with respect to the accuracy or completeness of the information furnished in this data sheet. This information is not intended as a warranty and Micrel does not assume responsibility for its use. Micrel reserves the right to change circuitry, specifications and descriptions at any time without notice. No license, whether express, implied, arising by estoppel or otherwise, to any intellectual property rights is granted by this document. Except as provided in Micrel's terms and conditions of sale for such products, Micrel assumes no liability whatsoever, and Micrel disclaims any express or implied warranty relating to the sale and/or use of Micrel products including liability or warranties relating to fitness for a particular purpose, merchantability, or infringement of any patent, copyright or other intellectual property right.

Micrel Products are not designed or authorized for use as components in life support appliances, devices or systems where malfunction of a product can reasonably be expected to result in personal injury. Life support devices or systems are devices or systems that (a) are intended for surgical implant into the body or (b) support or sustain life, and whose failure to perform can be reasonably expected to result in a significant injury to the user. A Purchaser's use or sale of Micrel Products for use in life support appliances, devices or systems is a Purchaser's own risk and Purchaser agrees to fully indemnify Micrel for any damages resulting from such use or sale.