

CMOS DUAL TIMER CIRCUIT

The μ PD5556 is a dual circuit version of the μ PD5555 timer IC. Being a CMOS circuit, the μ PD5556 circuit requires only a little current, and outperforms the bipolar version in characteristics such as operating voltage, reset pin function, input current, and oscillation frequency. Moreover, its circuit configuration is highly immune to chattering, so it is best suited for applications such as a one-shot multivibrator and pulse generator.

TYPICAL CHARACTERISTICS

- Recommended operating voltage : 3 to 16 V
- Circuit current : 150 μ A ($V_{DD} = 5$ V)
- Output saturation voltage : 0.14 V ($I_{SINK} = 3.2$ mA)

FEATURES

- Pin-compatible with the 556 type timer
- Requires only a small power supply bypass capacitance because of only a little switching noise occurring
0.047 μ F for $V_{DD} < 10$ V
0.1 μ F for $V_{DD} \geq 10$ V
- No interference occurs even if two or more units of this model are connected to the same power supply line.
- Setting the reset pin to a low level stops oscillation, thus clamping the output to a low level.
- Can drive both CMOS and TTL circuits.
- Sufficient provision to prevent electrostatic breakdown

PIN CONFIGURATION

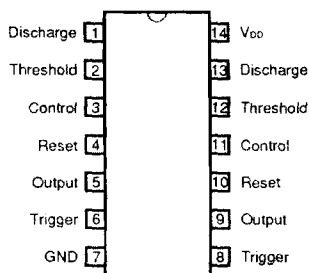

ORDERING INFORMATION

Part number	Package
μ PD5556C	14-pin plastic DIP (300 mil)
μ PD5556G	14-pin plastic SOP (225 mil)

EQUIVALENT CIRCUIT (1/2 CIRCUIT)

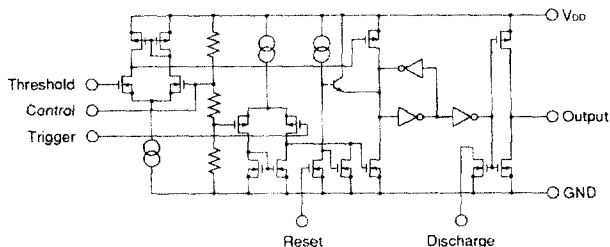

ABSOLUTE MAXIMUM RATINGS ($T_A = 25^\circ\text{C}$)

Parameter		Symbol	Rated value	Unit
Supply voltage		V_{DD}	-0.3 to +18	V
Input voltage (trigger, threshold, reset, control)		V_{IN}	$-0.3 \leq V_{IN} \leq V_{DD} + 0.3$	V
Output voltage (output and discharge) Note 4		V_O	$-0.3 \leq V_O \leq V_{DD} + 0.3$	V
Output current		I_O	100 Note 1	mA
Operating temperature range		T_A	-20 to +70	$^\circ\text{C}$
Storage temperature range		T_{stg}	-55 to +125	$^\circ\text{C}$
Power dissipation	(C package)	P_T	570 Note 2	mW
	(G package)		550 Note 3	

Notes 1. Be sure to use the product within the Power dissipation.

- The listed total loss applies when the ambient temperature is below 50°C . If the ambient temperature is 50°C or higher, the total loss should be derated at $-7.6 \text{ mW}/^\circ\text{C}$.
- The listed total loss applies when the ambient temperature is below 25°C . If the ambient temperature is 25°C or higher, the total loss should be derated at $-5.5 \text{ mW}/^\circ\text{C}$.
- This is an external voltage that can be applied to the output pin without deteriorating the quality of the product or causing damage to the product.

Be sure to use the product within the rated value under any conditions including power-on/off transitions. The output voltage that can be obtained during normal operation is within the output saturation voltage range.

RECOMMENDED OPERATING CONDITIONS ($T_A = 25^\circ\text{C}$)

Parameter	Symbol	Conditions	MIN	MAX.	Unit
Supply voltage	V_{DD}		3	16	V
Oscillation frequency	f	$V_{DD} = 3 \text{ to } 15 \text{ V}$	0.1	500 k	Hz
Output pulse width	$t_{W(OUT)}$	$V_{DD} = 3 \text{ to } 15 \text{ V}$	2 μ	10	Sec
Input voltage (trigger, threshold)	V_{IN}		0	V_{DD}	V
Input voltage Note 5 (control)	V_{IN}		2.0	$V_{DD} - 1$	V
Reset voltage (high level)	V_{RESETH}	$V_{DD} = 3 \text{ to } 15 \text{ V}$	2.0	V_{DD}	V
Reset voltage (low level)	V_{RESETL}	$V_{DD} = 3 \text{ to } 15 \text{ V}$	0	0.6	V
Output sink current	$I_{O(SINK)}$		0	3.2	mA
Output source current	$I_{O(SOURCE)}$		0	1	mA
Operating temperature range	T_A		-20	+70	$^\circ\text{C}$

Note 5. This parameter defines the voltage that can be applied when a PWM mode application circuit is configured by applying an external voltage to the control pin. Usually, a capacitance of $0.01 \mu\text{F}$ is connected as shown in the application circuit.

ELECTRICAL CHARACTERISTICS ($T_A = 25^\circ\text{C}$, $V_{DD} = +3$ to $+15$ V, unless otherwise specified)

Parameter	Symbol	Conditions	MIN.	TYP.	MAX.	Unit
Supply current	I_{DD}	$V_{DD} = 5$ V	0	150	500	μA
		$V_{DD} = 15$ V	0	200	700	
Threshold voltage	V_{in}			$2/3V_{DD}$		V
Threshold current	I_{in}	$V_{DD} = 15$ V		50		μA
		$V_{DD} = 5$ V		10		
		$V_{DD} = 3$ V		1		
Trigger voltage	V_{tr}			$1/3V_{DD}$		V
Trigger current	I_{tr}	$V_{DD} = 15$ V		50		μA
		$V_{DD} = 5$ V		10		
		$V_{DD} = 3$ V		1		
Reset voltage (Voltage used to set the output to a low level)	V_{reset}	$V_{DD} = 15$ V	0.6	1.1	2.0	V
		$V_{DD} = 3$ V	0.6	1.1	2.0	
Reset current	I_{reset}	$V_{RESET} = \text{GND}$, $V_{DD} = 15$ V		100		μA
		$V_{RESET} = \text{GND}$, $V_{DD} = 5$ V		20		
		$V_{RESET} = \text{GND}$, $V_{DD} = 3$ V		2		
Output saturation voltage (low)	V_{OL}	$V_{DD} = 15$ V, $I_{SINK} = 3.2$ mA	0	0.06	0.4	V
		$V_{DD} = 5$ V, $I_{SINK} = 3.2$ mA	0	0.14	0.4	
Output saturation voltage (high)	V_{OH}	$V_{DD} = 15$ V, $I_{SOURCE} = 1$ mA	14.25	14.85	15.00	V
		$V_{DD} = 5$ V, $I_{SOURCE} = 1$ mA	4.0	4.7	5.0	
Output rise time	t_{rise}	$R_L = 10$ M Ω , $C_L = 7$ pF, $V_{DD} = 5$ V		60		ns
Output fall time	t_{fall}	$R_L = 10$ M Ω , $C_L = 7$ pF, $V_{DD} = 5$ V		60		ns
Maximum oscillation frequency	f_{MAX}	Astable vibration	500			kHz
Propagation delay	t_{pd}	Monostable multivibration Minimum trigger voltage = $0.1 \cdot V_{DD}$		400		ns
Minimum trigger pulse width	$t_{w(trig)}$	$V_{DD} = 5$ V Minimum trigger voltage = $0.1 \cdot V_{DD}$		190		ns
Minimum reset pulse width	$t_{w(reset)}$	$V_{DD} = 5$ V Reset voltage = 0.6 V		0.6		μs
Control voltage	V_{CONT}			$2/3V_{DD}$		V
Timing error		$R_1, R_2 = 1$ k to 100 k Ω $C = 0.1$ μF $V_{DD} = 5$ to 15 V		2		%
Initial accuracy				50		ppm/ $^\circ\text{C}$
Temperature drift				1		%/V
Supply voltage drift						%/V

Notes 1. To prevent output switching pass-through current from causing noise on the power supply line, connect a bypass capacitor (having the capacitance listed below) to the V_{DD} pin (pin 14).

Capacitance: $C \geq 0.047 \mu\text{F}$ for $V_{DD} \leq 10 \text{ V}$
 $C \geq 0.1 \mu\text{F}$ for $V_{DD} > 10 \text{ V}$

2. If a reset signal for this IC is supplied from an external digital device operating on a supply voltage other than the one to which this IC is connected, Connect a resistor of $4.7 \text{ k}\Omega$ or higher in series to the reset pin.

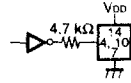
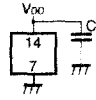

TYPICAL CHARACTERISTIC CURVES ($T_A = 25^\circ\text{C}$, TYP.)

I_{DD} - V_{DD} characteristic

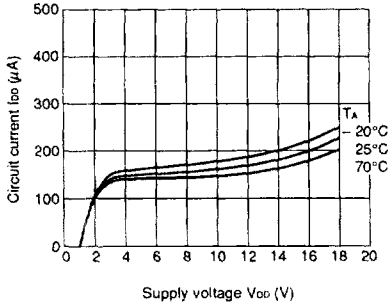

I_O SINK- V_{OL} characteristic

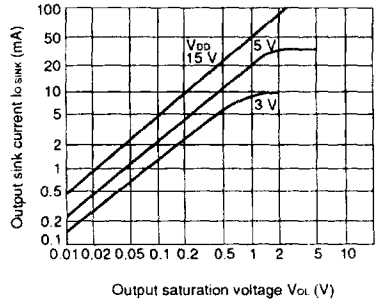

I_O SOURCE- ΔV characteristic

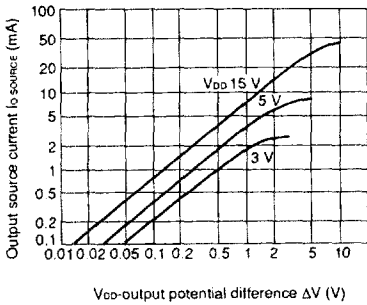

I_{DIS} SINK- V_{DIS} LOW characteristic

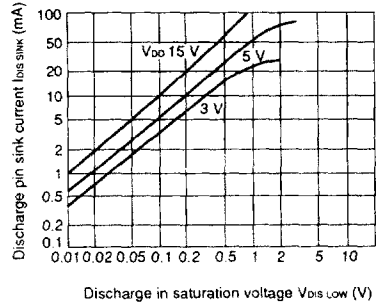

V_{OL} - T_A characteristic

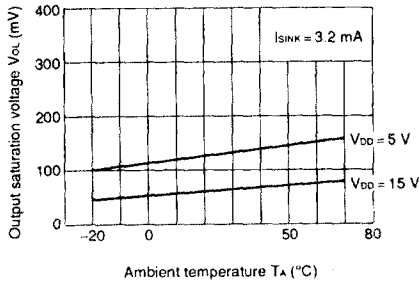

ΔV - T_A characteristic

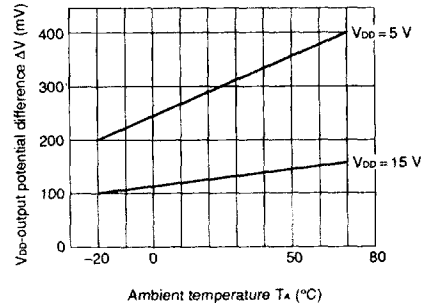

V_{DS} low- T_A characteristic

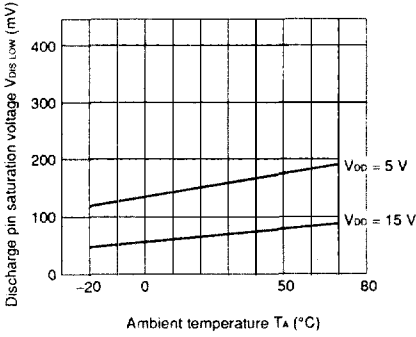

I_{DD} -f characteristic

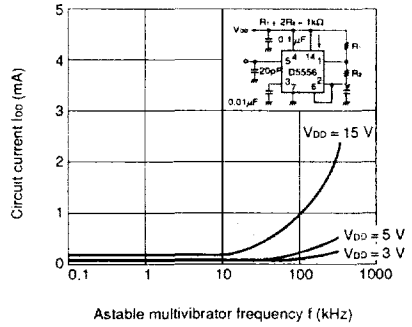

t_{pd} - V_{tr} characteristic

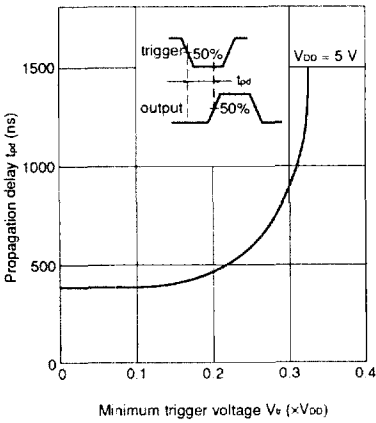

$t_w(t_r)$ - V_{tr} characteristic (monostable multivibrator)

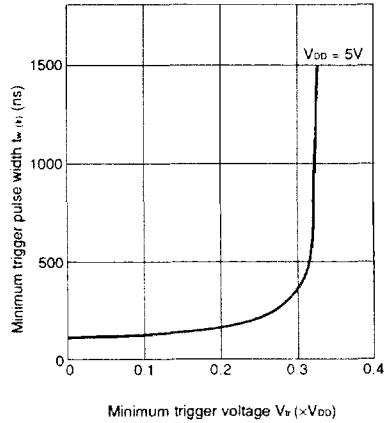

t_{pd} - T_A characteristic

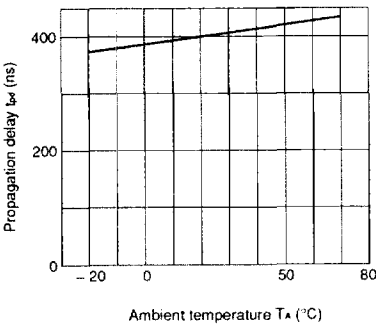

$t_w(t_r)$ - T_A characteristic

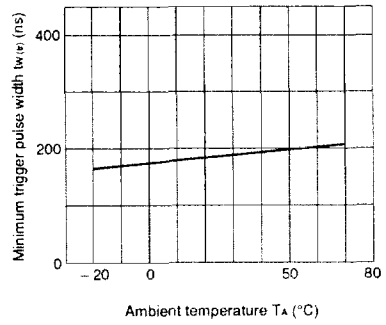

APPLICATION CIRCUITS

(1) Monostable multivibrator

Fig. a Monostable Multivibrator Example

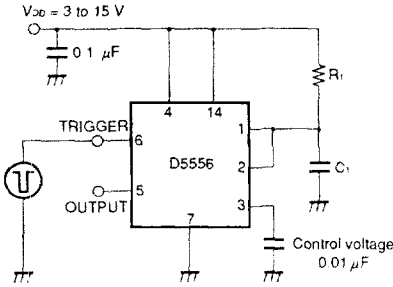

When the μPD5556 is configured as shown in Fig. a, it functions as a monostable multivibrator. Applying a voltage one-third as high as V_{DD} or less (trigger pulse*) to pin 6 (trigger pin) drives the output to a high level. Under this condition, capacitor C_1 starts charging through resistor R_1 . When C_1 is charged up to two-thirds as high as V_{DD} , pin 2 (threshold pin) is turned on and inverted to a low level. At this point, C_1 starts discharging through pin 1. When a trigger pulse is applied to pin 6 again, the same operation is repeated. Fig. b shows this operation. A capacitor connected to pin 3 functions as a nose filter for the control voltage. If pin 4 (reset pin) is connected to 2 V or higher (for example, by being connected to V_{DD}), the circuit operation can be stopped by switching it from 2 V or higher to a GND level.

The output pulse width (delay) is determined theoretically by (see Fig. c):

$$t = 1.1 \cdot C_1 \cdot R_1$$

The value obtained by this equation is only an approximate value, however. If it is necessary to obtain an accurate output pulse width, determine R_1 and C_1 through actual measurement and confirmation; a trimmer should be used as required. Moreover, R_1 should be 300 Ω or higher.

* Keep the trigger pulse width smaller than the output pulse width.

The application circuits and their parameters are for references only and are not intended for use in actual design-in's.

Fig. b Monostable Response Waveform

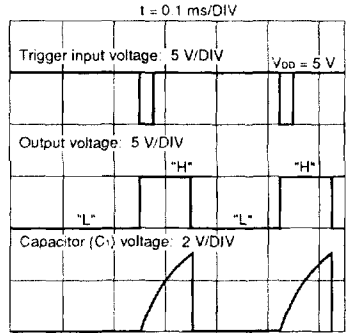

($R_1 = 9.1 \text{ k}\Omega$, $C_1 = 0.01 \text{ }\mu\text{F}$, $R_L = 1 \text{ k}\Omega$)

Fig. c Interrelationships among Output Pulse Width, R_1 , and C_1

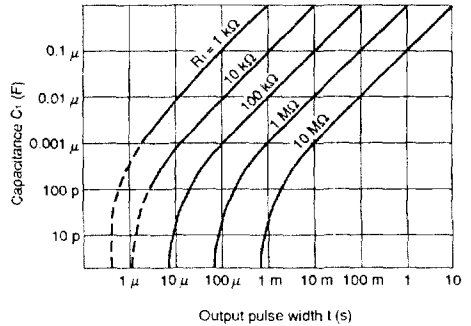

(2) Astable multivibrator example

Fig. d Astable Multivibrator Example

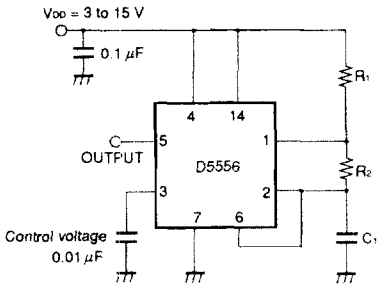

When the μPD5556 is used in a circuit configuration shown in Fig. d, the circuit is triggered by itself to operate as an astable multivibrator, because pin 6 (trigger pin) and pin 2 (threshold pin) are connected to each other. When the output voltage is high, capacitor C₁ is charged through R₁ and R₂. When C₁ is charged up to a voltage two-thirds as high as V_{DD}, the threshold pin is turned on, and the output pin becomes low. At this point C₁ starts discharging through R₂. When C₁ discharges, and the voltage across C₁ decreases to a voltage one-third as high as V_{DD}, the trigger pin is turned on, and the output voltage becomes high, causing the charge current to flow into C₁ through R₁ and R₂ again. This operation is shown in Fig. e. Because C₁ repeats charging and discharging between one-third as high as V_{DD} and two-thirds as high as V_{DD}, the oscillation frequency is not affected by the supply voltage.

Oscillation is represented theoretically using the following expressions.

When the output voltage is high, the charge time is : $t_1 = 0.693 (R_1 + R_2) C_1$ (1)

When the output voltage is low, the discharge time is : $t_2 = 0.693 \cdot R_2 \cdot C_1$ (2)

Adding expressions (1) and (2) determines period T : $T = t_1 + t_2 = 0.693 (R_1 + 2R_2) C_1$ (3)

Therefore, the oscillation frequency is

(see Fig. f for reference)

$$f = \frac{1}{T} = \frac{1.44}{(R_1 + 2R_2) C_1} \quad \text{..... (4)}$$

The duty cycle is determined by the equation (5)

$$D = \frac{R_2}{R_1 + 2R_2} \quad \text{..... (5)}$$

The values obtained this way are approximate values, however. If it is necessary to obtain an accurate oscillation frequency, determine R₁, R₂, and C₁ through actual measurement and confirmation; a trimmer should be used as required. Moreover, R₁ and R₂ should be 300 Ω or higher.

Fig. e Astable Multivibrator Response Waveform

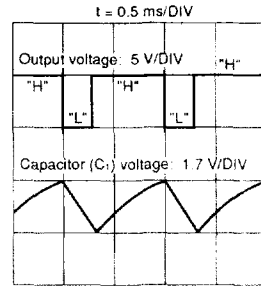

(R₁ = R₂ = 4.8 kΩ, C₁ = 0.1 μF, R_L = 1 kΩ)

Fig. f Interrelationships among Oscillation Frequency, R₁, R₂, and C₁

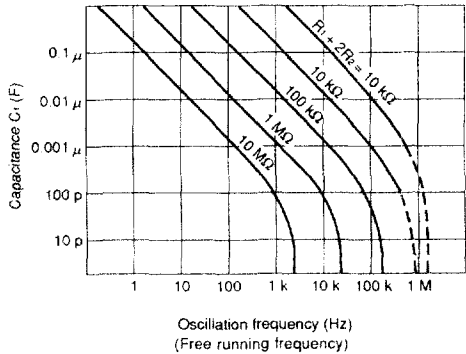

14PIN PLASTIC DIP (300 mil)

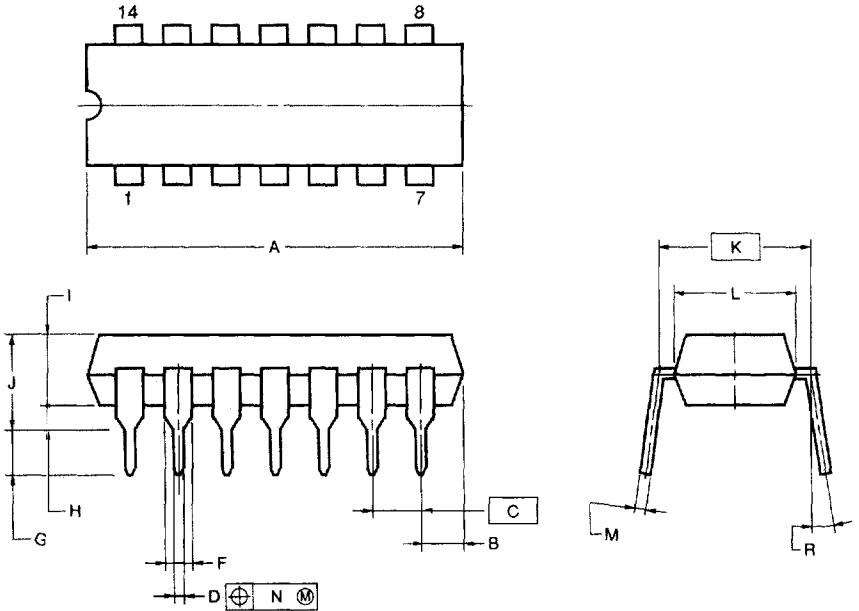

NOTES

- 1) Each lead centerline is located within 0.25 mm (0.01 inch) of its true position (T.P.) at maximum material condition.
- 2) Item "K" to center of leads when formed parallel.

ITEM	MILLIMETERS	INCHES
A	20.32 MAX.	0.800 MAX.
B	2.54 MAX.	0.100 MAX.
C	2.54 (T.P.)	0.100 (T.P.)
D	0.50±0.10	0.020 ^{+0.004} _{-0.005}
F	1.2 MIN.	0.047 MIN.
G	3.6±0.3	0.142±0.012
H	0.51 MIN.	0.020 MIN.
J	4.31 MAX.	0.170 MAX.
K	7.62 (T.P.)	0.300 (T.P.)
L	6.4	0.252
M	0.25 ^{+0.10} _{-0.05}	0.010 ^{+0.004} _{-0.003}
N	0.25	0.01
R	0-15°	0-15°

P14C-100-300B1-1

14 PIN PLASTIC SOP (225 mil)

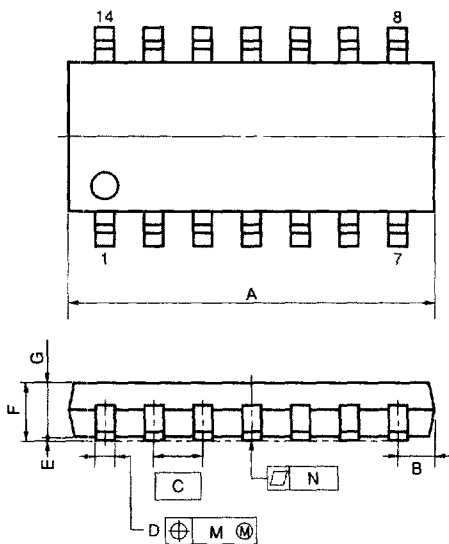

detail of lead end

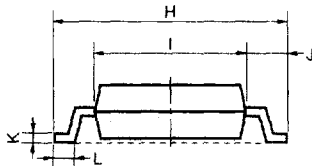

NOTE

Each lead centerline is located within 0.12 mm (0.005 inch) of its true position (T.P.) at maximum material condition.

ITEM	MILLIMETERS	INCHES
A	10.46 MAX.	0.412 MAX.
B	1.42 MAX.	0.056 MAX.
C	1.27 (T.P.)	0.050 (T.P.)
D	0.40 ^{+0.10} _{-0.05}	0.016 ^{+0.004} _{-0.003}
E	0.1±0.1	0.004±0.004
F	1.8 MAX.	0.071 MAX.
G	1.49	0.059
H	6.5±0.3	0.256±0.012
I	4.4	0.173
J	1.1	0.043
K	0.15 ^{+0.10} _{-0.05}	0.006 ^{+0.004} _{-0.002}
L	0.6±0.2	0.024 ^{+0.008} _{-0.009}
M	0.12	0.005
N	0.10	0.004
P	3° ^{+7°} _{-3°}	3° ^{+7°} _{-3°}

S14GM-50-225B, C-4

RECOMMENDED SOLDERING CONDITIONS

The conditions listed below shall be met when soldering the μPD5556.

Please consult with our sales offices in case any other soldering process is used, or in case soldering is done under different conditions.

Surface-Mount Devices

For details of the recommended soldering conditions, refer to our document *SMD Surface Mount Technology Manual* (IEI-1207).

μPD5556G

Soldering process	Soldering conditions	Symbol
Infrared reflow	Peak package's surface temperature: 230°C Reflow time: 30 seconds or less (at 210°C or more) Maximum allowable number of reflow processes: 1 Exposure limit: None Note	IR30-00
VPS	Peak package's surface temperature: 215°C Reflow time: 40 seconds or less (at 200°C or more) Maximum allowable number of reflow processes: 1 Exposure limit: None Note	VP15-00
Wave soldering	Temperature in the soldering vessel: 260°C or less Soldering time: 10 seconds or less Maximum allowable number of reflow processes: 1 Exposure limit: None Note	WS60-00
Partial heating method	Pin temperature: 300°C or less Flow time: 10 seconds or less Exposure limit: None Note	

Note Exposure limit before soldering after dry-pack package is opened.

Storage conditions: Temperature of 25°C or less and maximum relative humidity of 65% or less

Caution Do not apply more than a single process at once, except for "Partial heating method."

Through-Hole Mount Devices

μPD5556C

Soldering process	Soldering conditions
Wave soldering	Temperature in the soldering vessel: 260°C or less Soldering time: 10 seconds or less