

DS26F32C/DS26F32M Quad Differential Line Receiver

General Description

The DS26F32 is a quad differential line receiver designed to meet the requirements of EIA Standards RS-422 and RS-423, and Federal Standards 1020 and 1030 for balanced and unbalanced digital data transmission.

The DS26F32 offers improved performance due to the use of state-of-the-art L-FAST bipolar technology. The L-FAST technology allows for higher speeds and lower currents by utilizing extremely short gate delay times. Thus, the DS26F32 features lower power, extended temperature range, and improved specifications.

The device features an input sensitivity of 200 mV over the input common mode range of $\pm 7.0V$. The DS26F32 provides an enable function common to all four receivers and TRI-STATE® outputs with 8.0 mA sink capability. Also, a fail-safe input/output relationship keeps the outputs high when the inputs are open.

The DS26F32 offers optimum performance when used with the DS26F31 Quad Differential Line Driver.

Features

- Military temperature range
- Input voltage range of $\pm 7.0V$ (differential or common mode) $\pm 0.2V$ sensitivity over the input voltage range
- Meets all the requirements of EIA standards RS-422 and RS-423
- High input impedance (18k typical)
- 30 mV input hysteresis
- Operation from single +5.0V supply
- Input pull-down resistor prevents output oscillation on unused channels
- TRI-STATE outputs, with choice of complementary enables, for receiving directly onto a data bus
- Propagation delay 15 ns typical

Connection Diagrams

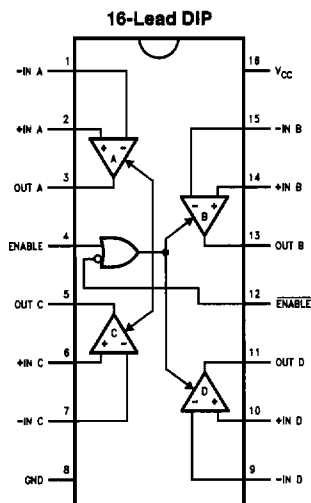

Top View

TL/F/9615-1

Order Number DS26F32CJ or DS26F32MJ
See NS Package Number J16A

For Complete Military 883 Specifications,
see RETS Datasheet.

Order Number DS26F32ME/883,
DS26F32MJ/883 or DS26F32MW/883
See NS Package Number E20A, J16A or W16A

20-Lead Ceramic Leadless Chip Carrier

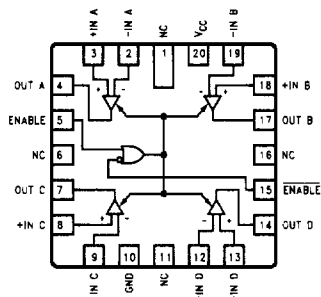

TL/F/9615-7

Function Table (Each Receiver)

Differential Inputs	Enables		Outputs
$V_{ID} = (V_{IN+}) - (V_{IN-})$	E	\bar{E}	OUT
$V_{ID} \geq 0.2V$	H	X	H
	X	L	H
$V_{ID} \leq -0.2V$	H	X	L
	X	L	L
X	L	H	Z

H = High Level
L = Low Level
X = Immaterial

Absolute Maximum Ratings (Note 1)

If Military/Aerospace specified devices are required, please contact the National Semiconductor Sales Office/Distributors for availability and specifications.

Storage Temperature Range	Ceramic DIP	-65°C to +175°C
Operating Temperature Range	DS26F32M	-55°C to +125°C
	DS26F32C	0°C to +70°C
Lead Temperature	Ceramic DIP (soldering, 60 sec)	300°C
Maximum Power Dissipation* at 25°C	Cavity Package	1500 mW
Supply Voltage		7.0V

*Derate cavity package 10 mW/°C above 25°C.

Common Mode Voltage Range	±25V
Differential Input Voltage	±25V
Enable Voltage	7.0V
Output Sink Current	50 mA

Operating Range

DS26F32C	Temperature	0°C to +70°C
	Supply Voltage	4.75V to 5.25V
DS26F32M	Temperature	-55°C to +125°C
	Supply Voltage	4.5V to 5.5V

Electrical Characteristics Over operating range, unless otherwise specified (Notes 2 and 3)

Symbol	Parameter	Conditions	Min	Typ	Max	Units
V _{TH}	Differential Input Voltage	-7.0V ≤ V _{CM} ≤ +7.0V, V _O = V _{OL} or V _{OH}	-0.2	±0.06	+0.2	V
R _I	Input Resistance	-15V ≤ V _{CM} ≤ +15V, One Input AC Ground	14	18		kΩ
I _I	Input Current (under Test)	V _I = +15V, Other Input -15V ≤ V _I ≤ +15V			2.3	mA
		V _I = -15V, Other Input -15V ≤ V _I ≤ +15V			-2.8	
V _{OH}	Output Voltage HIGH	V _{CC} = Min, ΔV _I = +1.0V, V _{ENABLE} = 0.8V, I _{OH} = -440 μA	0°C to +70°C	2.8	3.4	V
			-55°C to +125°C	2.5	3.4	
V _{OL}	Output Voltage LOW	V _{CC} = Min, ΔV _I = -1.0V, V _{ENABLE} = 0.8V	I _{OL} = 4.0 mA		0.4	V
			I _{OL} = 8.0 mA		0.45	
V _{IL}	Enable Voltage LOW				0.8	V
V _{IH}	Enable Voltage HIGH		2.0			V
V _{IC}	Enable Clamp Voltage	V _{CC} = Min, I _I = -18 mA			-1.5	V
I _{OZ}	Off State (High Impedance) Output Current	V _{CC} = Max	V _O = 2.4V		20	μA
			V _O = 0.4V		-20	
I _{IL}	Enable Current LOW	V _I = 0.4V		-0.2	-0.36	mA
I _{IH}	Enable Current HIGH	V _I = 2.7V		0.5	10	μA
I _I	Enable Input High Current	V _I = 5.5V		1.0	50	μA
I _{OS}	Output Short Circuit Current	V _O = 0V, V _{CC} = Max, (Note 4) ΔV _I = +1.0V	-15	-50	-85	mA
I _{CC}	Supply Current	V _{CC} = Max, All V _I = GND, Outputs Disabled		30	50	mA
V _{HYST}	Input Hysteresis	T _A = 25°C, V _{CC} = 5.0V, V _{CM} = 0V		30		mV

Note 1: "Absolute Maximum Ratings" are those values beyond which the safety of the device cannot be guaranteed. They are not meant to imply that the devices should be operated at these limits. The tables of "Electrical Characteristics" provide conditions for actual device operation.

Note 2: Unless otherwise specified min/max limits apply across the -55°C to +125°C temperature range for the DS26F32M and across the 0°C to +70°C range for the DS26F32C. All typicals are given for V_{CC} = 5V and T_A = 25°C.

Note 3: All currents into the device pins are positive; all currents out of the device pins are negative. All voltages are reference to ground unless otherwise specified.

Note 4: Only one output at a time should be shorted.

Switching Characteristics $V_{CC} = 5.0V, T_A = 25^\circ C$

Symbol	Parameter	Conditions	Min	Typ	Max	Units
t_{PLH}	Input to Output	Figures 2, 3		15	22	ns
t_{PHL}	Input to Output					
t_{LZ}	Enable to Output	Figures 2, 4		14	18	ns
t_{HZ}	Enable to Output					
t_{ZL}	Enable to Output					
t_{ZH}	Enable to Output			13	18	ns
				12	16	ns

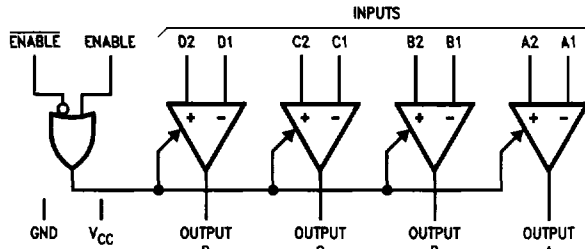

FIGURE 1. Logic Symbol

TL/F/9615-2

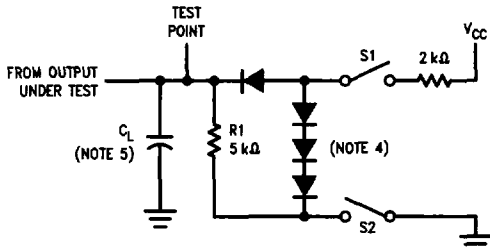

FIGURE 2. Load Test Circuit for Three-State Outputs

TL/F/9615-3

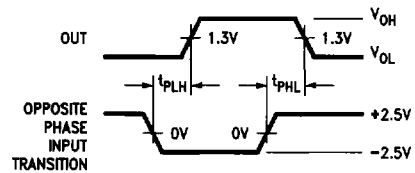

FIGURE 3. Propagation Delay (Notes 1, 2 and 3)

TL/F/9615-4

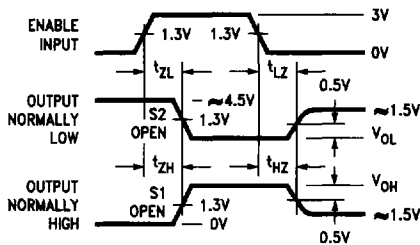

FIGURE 4. Enable and Disable Times (Notes 1, 2 and 3)

TL/F/9615-5

Note 1: Diagram shown for ENABLE Low.

Note 2: S1 and S2 of Load Circuit are closed except where shown.

Note 3: Pulse Generator of all Pulses: Rate ≤ 1.0 MHz, $Z_O = 50\Omega$, $t_r \leq 6.0$ ns, $t_f \leq 6.0$ ns.

Note 4: All diodes are IN916 or IN3064.

Note 5: C_L includes probe and jig capacitance.

Typical Application

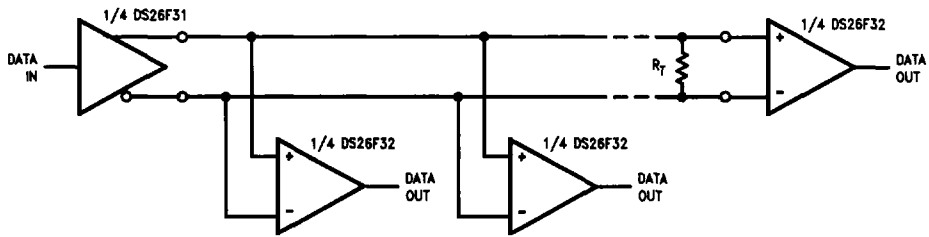

FIGURE 5

TL/F/9615-6