

MMBT3906-G (PNP) RoHS Device

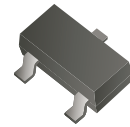

Features

- Epitaxial planar die construction
- As complementary type, the NPN transistor MMBT3904-G is recommended

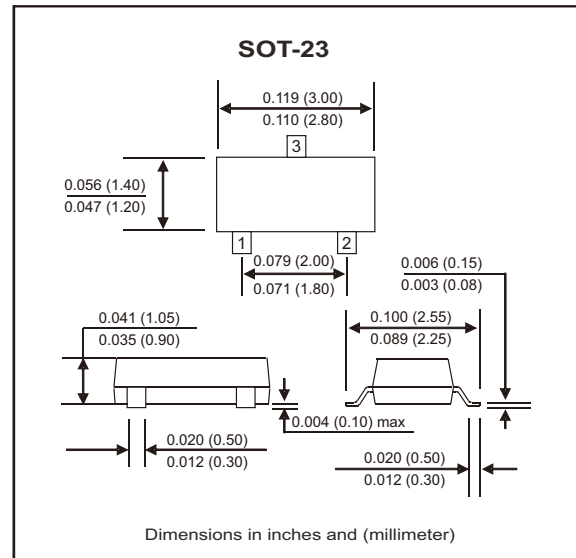
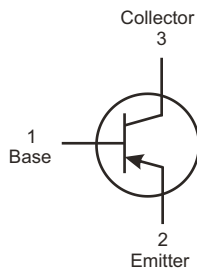

Maximum Ratings (at TA=25°C unless otherwise noted)

Parameter	Symbol	Min	Typ	Max	Unit
Collector-Base voltage	V _{CB0}			-40	V
Collector-Emitter voltage	V _{CE0}			-40	V
Emitter-Base voltage	V _{EB0}			-5	V
Collector current-Continuous	I _C			-0.2	A
Collector dissipation	P _C			0.2	W
Storage temperature and junction temperature	T _{STG} , T _J	-55		+150	°C

Electrical Characteristics (at TA=25°C unless otherwise noted)

Parameter	Conditions	Symbol	Min	Max	Unit
Collector-Base breakdown voltage	I _C = -100μA , I _E = 0	V _{(BR)CB0}	-40		V
Collector-Emitter breakdown voltage	I _C = -1mA , I _B = 0	V _{(BR)CE0}	-40		V
Emitter-Base breakdown voltage	I _E = -100μA , I _C = 0	V _{(BR)EB0}	-5		V
Collector cut-off current	V _{CB} = -40V , I _E = 0	I _{CB0}		-0.1	μA
Collector cut-off current	V _{CE} = -40V , I _B = 0	I _{CE0}		-0.1	μA
Emitter cut-off current	V _{EB} = -5V , I _C = 0	I _{EB0}		-0.1	μA
DC current gain	V _{CE} = -1V , I _C = -10mA	h _{FE(1)}	100	300	
	V _{CE} = -1V , I _C = -50mA	h _{FE(2)}	60		
	V _{CE} = -1V , I _C = -100mA	h _{FE(3)}	30		
Collector-Emitter saturation voltage	I _C = -50mA , I _B = -5mA	V _{CE(sat)}		-0.4	V
Base-Emitter saturation voltage	I _C = -50mA , I _B = -5mA	V _{BE(sat)}		-0.95	V
Transition frequency	V _{CE} = -20V , I _C = -10mA f = 100MHz	f _T	300		Mhz
Delay time	V _{CC} = -3.0V , V _{BE} = -0.5V	t _d		35	nS
Rise time	I _C = -10mA , I _{B1} = -1.0mA	t _r		35	nS
Storage time	V _{CC} = -3.0V _{dc} , I _C = -10mA	t _s		225	nS
Fall time	I _{B1} = I _{B2} = -1.0mA	t _f		75	nS

Company reserves the right to improve product design , functions and reliability without notice.

REV:B

RATING AND CHARACTERISTIC CURVES (MMBT3906-G)

Fig.1 - Static Characteristic

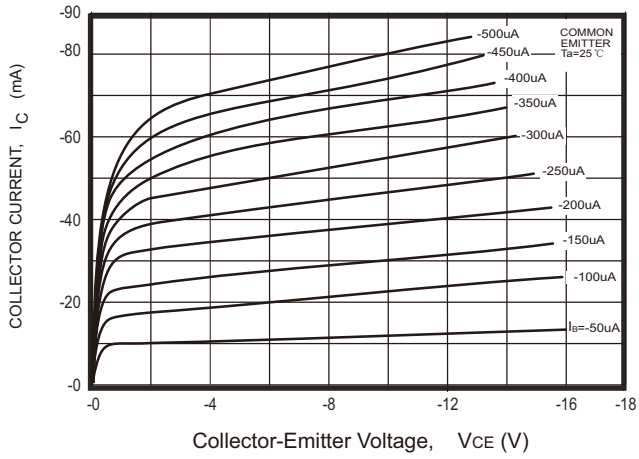

Fig.2 - $h_{FE} - I_c$

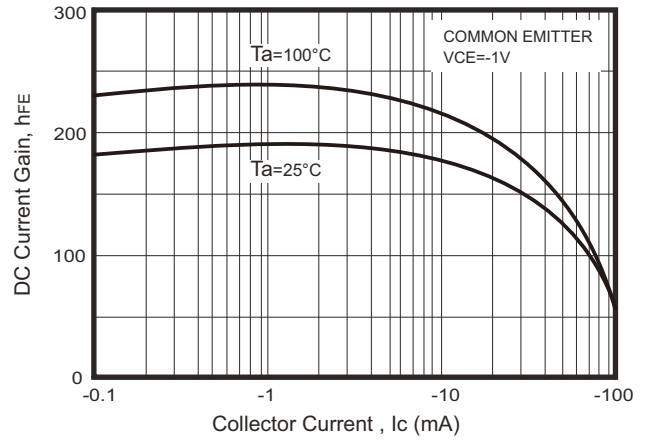

Fig.3 - $V_{CEsat} - I_c$

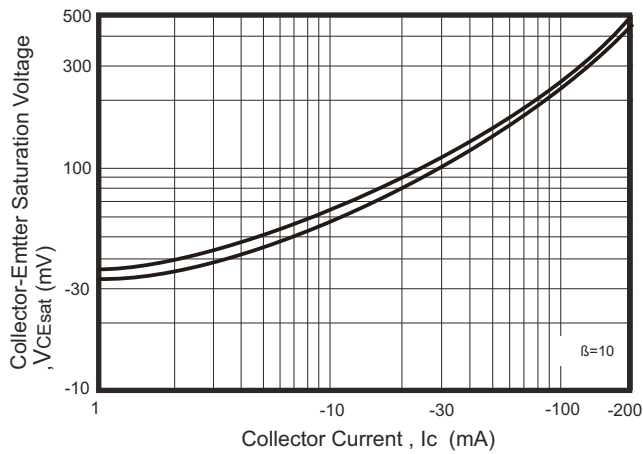

Fig.4 - $V_{BEsat} - I_c$

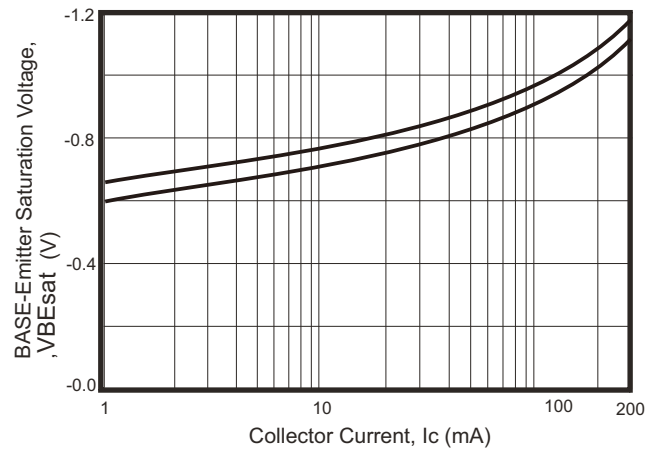

Fig.5 - $I_c - V_{BE}$

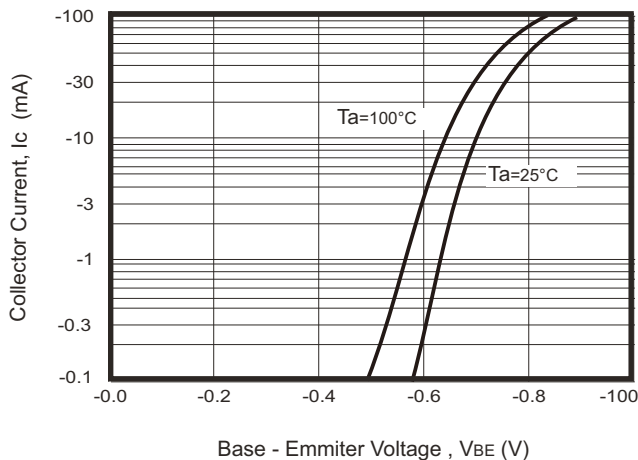
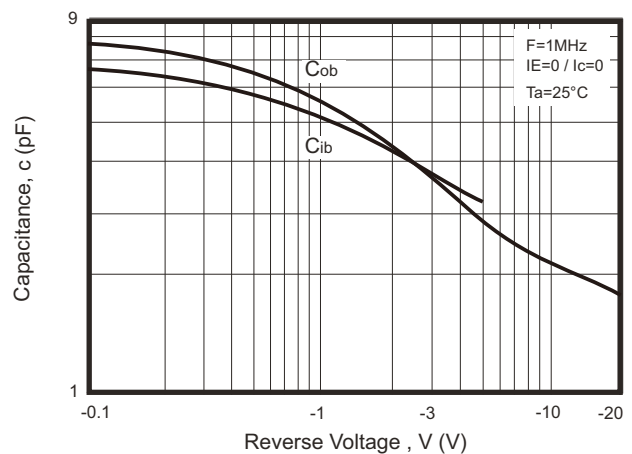

Fig.6 - $C_{ob}/C_{ib} - V_{CB}/V_{EB}$



Company reserves the right to improve product design, functions and reliability without notice.

RATING AND CHARACTERISTIC CURVES (MMBT3906-G)

Fig.7 - f_r — I_c

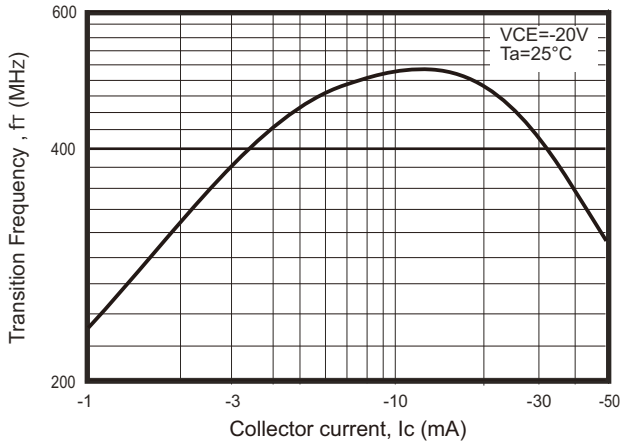
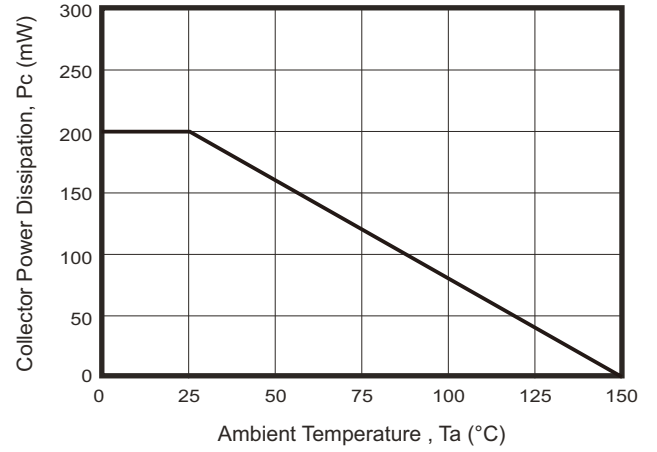
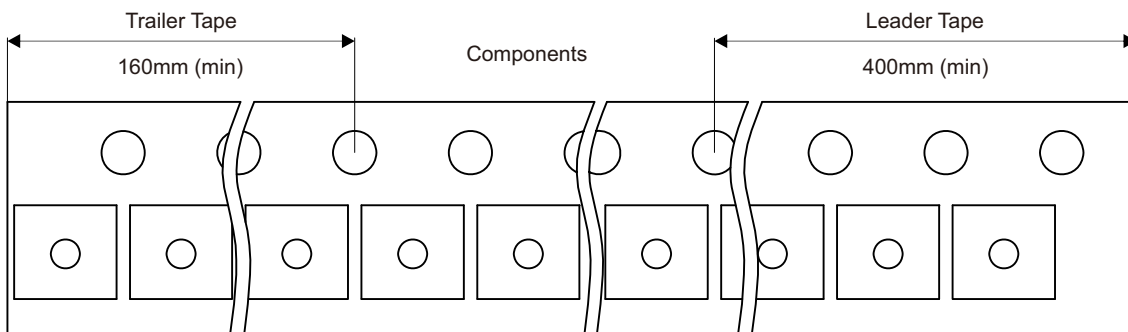
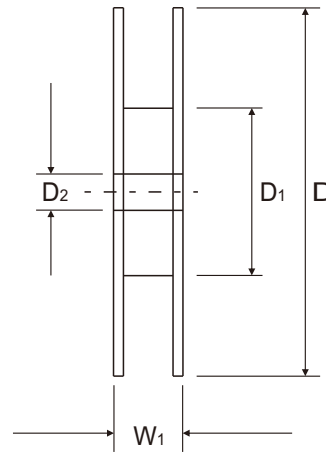
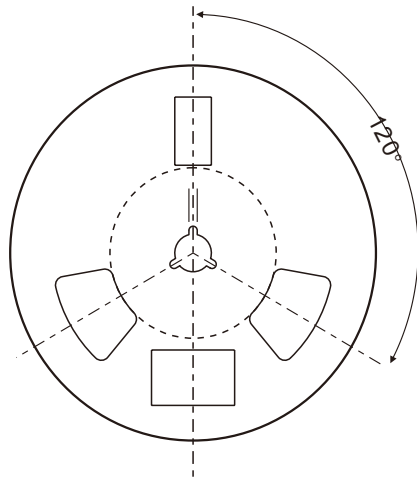
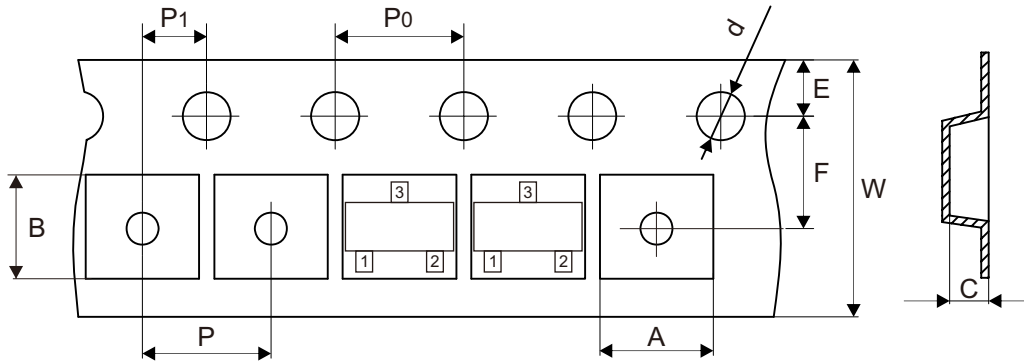

Fig.8 - P_c — T_a



Reel Taping Specification



SOT-23	SYMBOL	A	B	C	d	D	D1	D2
	(mm)	3.15 ± 0.10	2.77 ± 0.10	1.22 ± 0.10	1.50 ± 0.10	178 ± 1.00	54.40 ± 0.40	13.00 ± 0.20
	(inch)	0.124 ± 0.004	0.109 ± 0.004	0.048 ± 0.004	0.059 ± 0.004	7.008 ± 0.039	2.142 ± 0.016	0.512 ± 0.008

SOT-23	SYMBOL	E	F	P	P0	P1	W	W1
	(mm)	1.75 ± 0.10	3.50 ± 0.05	4.00 ± 0.10	4.00 ± 0.10	2.00 ± 0.10	8.00 + 0.30 / - 0.10	9.50 ± 1.00
	(inch)	0.069 ± 0.004	0.138 ± 0.002	0.157 ± 0.004	0.157 ± 0.004	0.079 ± 0.004	0.315 + 0.012 / - 0.004	0.374 ± 0.039

Company reserves the right to improve product design, functions and reliability without notice.

Marking Code

Code: Per A. D.

Part Number	Marking Code
MMBT3906-G	2A

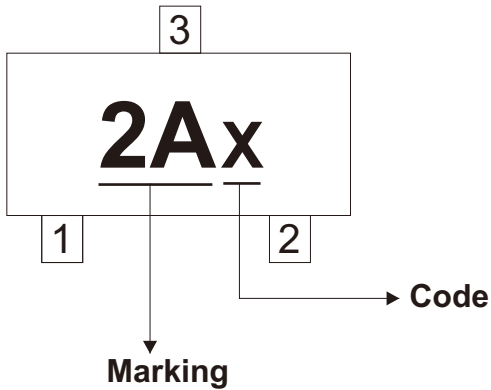

Year(odd)-Month	Code	Year(Even)-Month	Code
XXX1-01	J	XXX2-01	W
XXX1-02	O	XXX2-02	N
XXX1-03	L	XXX2-03	Y
XXX1-04	C	XXX2-04	T
XXX1-05	K	XXX2-05	R
XXX1-06	B	XXX2-06	H
XXX1-07	P	XXX2-07	A
XXX1-08	D	XXX2-08	I
XXX1-09	M	XXX2-09	U
XXX1-010	E	XXX2-010	X
XXX1-011	G	XXX2-011	Z
XXX1-012	F	XXX2-012	S

Suggested PAD Layout

SIZE	SOT-23	
	(mm)	(inch)
A	0.80	0.031
B	1.90	0.075
C	2.02	0.080
D	2.82	0.111

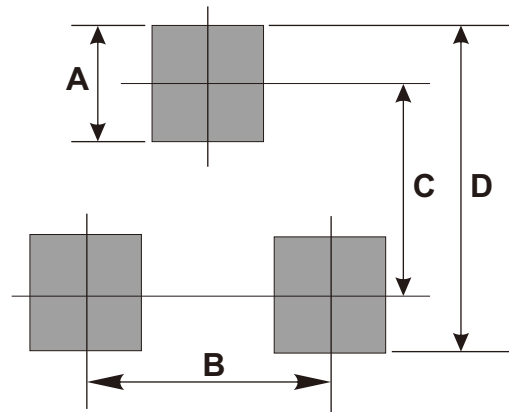

Standard Packaging

Case Type	REEL PACK	
	REEL (pcs)	Reel Size (inch)
SOT-23	3,000	7

Company reserves the right to improve product design , functions and reliability without notice.