



CY7C243
CY7C244

4K x 8 Reprogrammable PROM

Features

- CMOS for optimum speed/power
- Windowed for reprogrammability
- High speed
 - 20 ns (commercial)
 - 25 ns (military)
- Low power
 - 550 mW (commercial)
 - 660 mW (military)
- EPROM technology 100% programmable
- 300-mil or 600-mil packaging available
- $5V \pm 10\% V_{CC}$, commercial and military

- Capable of withstanding greater than 2001V static discharge
- TTL-compatible I/O
- Direct replacement for bipolar PROMs

Functional Description

The CY7C243 and CY7C244 are high-performance 4K x 8 CMOS PROMs. The CY7C243 and CY7C244 are packaged in 300-mil-wide and 600-mil-wide packages respectively. The reprogrammable packages are equipped with an erasure window. When exposed to UV light, these PROMs are erased and can then be reprogrammed. The memory cells utilize proven EPROM floating-gate technology and byte-wide intelligent programming algorithms.

The CY7C243 and CY7C244 are plug-in replacements for bipolar devices and offer the advantages of lower power, superior performance and programming yield. The EPROM cell requires only 12.5V for the supervoltage and low current requirements allow for gang programming. The EPROM cells allow for each memory location to be tested 100%, as each cell is programmed, erased, and repeatedly exercised prior to encapsulation. Each PROM is also tested for AC performance to guarantee that after customer programming the product will meet DC and AC specification limits.

Read is accomplished by placing an active LOW signal on \overline{CS}_1 and an active HIGH on \overline{CS}_2 . The contents of the memory location addressed by the address line ($A_0 - A_{11}$) will become available on the output lines ($O_0 - O_7$).

Logic Block Diagram

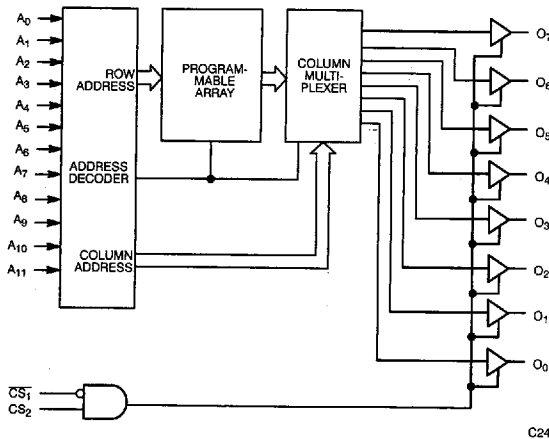

Pin Configurations

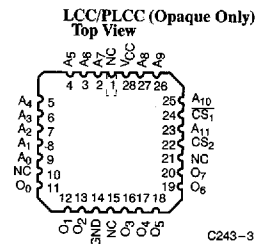
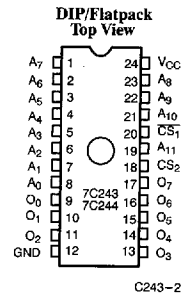

Selection Guide

		7C243-20 7C244-20	7C243-25 7C244-25	7C243-35 7C244-35	7C243-45 7C244-45	7C243-55 7C244-55
Maximum Access Time (ns)		20	25	35	45	55
Maximum Operating Current (mA)	Commercial	100	100	80	80	80
	Military		120	100	100	100

Maximum Ratings

(Above which the useful life may be impaired. For user guidelines, not tested.)

Storage Temperature	-65°C to +150°C
Ambient Temperature with Power Applied	-55°C to +125°C
Supply Voltage to Ground Potential (V _{CC} to GND)	-0.5V to +7.0V
DC Voltage Applied to Outputs in High Z State	-0.5V to +7.0V
DC Input Voltage	-3.0V to +7.0V
DC Program Voltage (Pin 19 DIP, Pin 23 LCC)	13.0V

Static Discharge Voltage (per MIL-STD-883, Method 3015)	>2001V
Latch-Up Current	>200 mA
UV Exposure	7258 Wsec/cm ²

Operating Range

Range	Ambient Temperature	V _{CC}
Commercial	0°C to +70°C	5V ± 10%
Industrial ^[1]	-40°C to +85°C	5V ± 10%
Military ^[2]	-55°C to +125°C	5V ± 10%

Electrical Characteristics Over the Operating Range^[3, 4]

Parameter	Description	Test Conditions	7C243-20, 25 7C244-20, 25		7C243-35, 45, 55 7C244-35, 45, 55		Unit
			Min.	Max.	Min.	Max.	
V _{OH}	Output HIGH Voltage	V _{CC} = Min., I _{OH} = -2.0 mA	2.4				V
V _{OH}	Output HIGH Voltage	V _{CC} = Min., I _{OH} = -4.0 mA			2.4		V
V _{OL}	Output LOW Voltage	V _{CC} = Min., I _{OL} = 8 mA (6 mA Mil)		0.4			V
V _{OL}	Output LOW Voltage	V _{CC} = Min., I _{OL} = 16 mA				0.4	V
V _{IH}	Input HIGH Level		2.0	V _{CC} + 0.3	2.0	V _{CC} + 0.3	V
V _{IL}	Input LOW Level			0.8		0.8	V
I _{IX}	Input Current	GND ≤ V _{IN} ≤ V _{CC}	-10	+10	-10	+10	μA
V _{CD}	Input Diode Clamp Voltage		Note 4		Note 4		
I _{OZ}	Output Leakage Current	0 ≤ V _{OUT} ≤ V _{CC} , Output Disabled	-10	+10	-10	+10	μA
I _{OS}	Output Short Circuit Current ^[5]	V _{CC} = Max., V _{OUT} = GND	-20	-90	-20	-90	mA
I _{CC}	Power Supply Current	V _{CC} = Max., I _{OUT} = 0 mA	Com'l	100		80	mA
			Mil		120	100	
V _{PP}	Programming Supply Voltage		12	13	12	13	V
I _{PP}	Programming Supply Current			50		50	mA

Capacitance^[4]

Parameter	Description	Test Conditions	Max.	Unit
C _{IN}	Input Capacitance	T _A = 25°C, f = 1 MHz, V _{CC} = 5.0V	10	pF
C _{OUT}	Output Capacitance		10	pF

Notes:

- See the Ordering Information section regarding industrial temperature range specification.
- T_A is the "instant on" case temperature.
- See the last page of this specification for Group A subgroup testing information.
- See the "Introduction to CMOS PROMs" section of the Cypress Data Book for general information on testing.
- For test purposes, not more than one output at a time should be shorted. Short circuit test duration should not exceed 30 seconds.

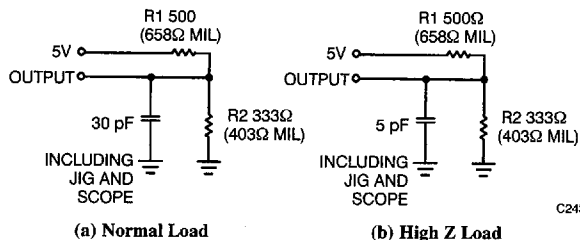
AC Test Loads and Waveforms^[4]
Test Load for -20 through -25 speeds

C243-4

C243-5

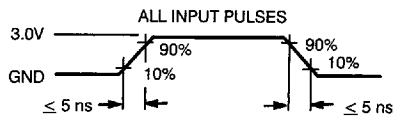

Equivalent to: THÉVENIN EQUIVALENT

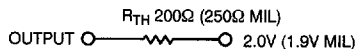
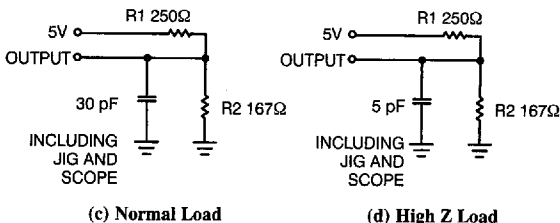

Test Load for -35 through -55 speeds

C243-6

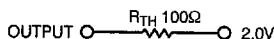
Equivalent to: THÉVENIN EQUIVALENT

Switching Characteristics Over the Operating Range^[2, 3, 4]

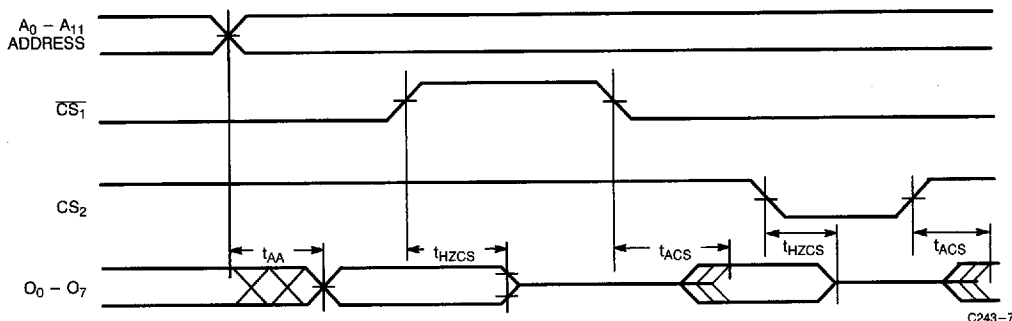
Parameter	Description	7C243-20 7C244-20		7C243-25 7C244-25		7C243-35 7C244-35		7C243-45 7C244-45		7C243-55 7C244-55		Unit
		Min.	Max.	Min.	Max.	Min.	Max.	Min.	Max.	Min.	Max.	
t_{AA}	Address to Output Valid		20		25		35		45		55	ns
t_{HZCS} (Com'l)	Chip Select Inactive to High Z		12		12		20		25		25	ns
t_{HZCS} (Mil)	Chip Select Inactive to High Z				15		20		25		25	ns
t_{ACS} (Com'l)	Chip Select Active to Output Valid		12		12		20		25		25	ns
t_{ACS} (Mil)	Chip Select Active to Output Valid				15		20		25		25	ns

Switching Waveforms^[4]

C243-7

4

Erase Characteristics

Wavelengths of light less than 4000 Å begin to erase the devices in the windowed package. For this reason, an opaque label should be placed over the window if the PROM is exposed to sunlight or fluorescent lighting for extended periods of time.

The recommended dose of ultraviolet light for erasure is a wavelength of 2537 Å for a minimum dose (UV intensity multiplied by exposure time) of 25 Wsec/cm². For an ultraviolet lamp with a 12 mW/cm² power rating, the exposure time would be approximately 35 minutes. The CY7C243 or CY7C244 needs to be within 1 inch of the lamp during erasure. Permanent damage may result if the PROM is exposed to high-intensity UV light for an extended period of time. 7258 Wsec/cm² is the recommended maximum dosage.

Operating Modes

Read is the normal operating mode for a programmed device. In this mode, all signals are normal TTL levels. The PROM is addressed with a 12-bit field, an active LOW signal is applied to \overline{CS}_1 , an active HIGH is applied to CS₂, and the contents of the addressed location appear on the data out pins.

Programming Information

Programming support is available from Cypress as well as from a number of third-party software vendors. For detailed programming information, including a listing of software packages, please see the PROM Programming Information located at the end of this section. Programming algorithms can be obtained from any Cypress representative.

Table 1. Mode Selection

Mode	Pin Function ^[6]							
	Read or Output Disable	A ₁₁	A ₁₀	A ₉	A ₈	\overline{CS}_1	CS ₂	O ₇ - O ₀
Program		V _{PP}	LATCH	PGM	\overline{VFY}	\overline{CS}_1	NA	D ₇ - D ₀
Read		A ₁₁	A ₁₀	A ₉	A ₈	V _{IL}	V _{IH}	O ₇ - O ₀
Output Disable		A ₁₁	A ₁₀	A ₉	A ₈	V _{IH}	X	High Z
Output Disable		A ₁₁	A ₁₀	A ₉	A ₈	X	V _{IL}	High Z

Notes:

 6. X can be V_{IL} or V_{IH}.

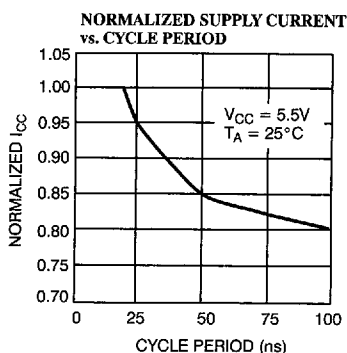
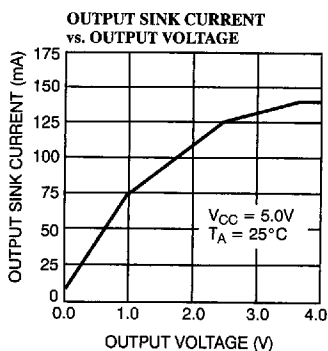
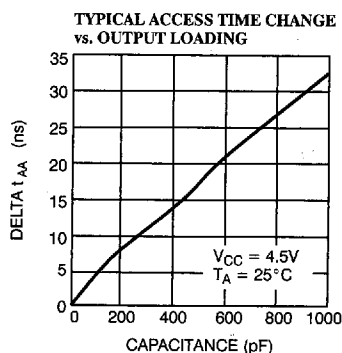
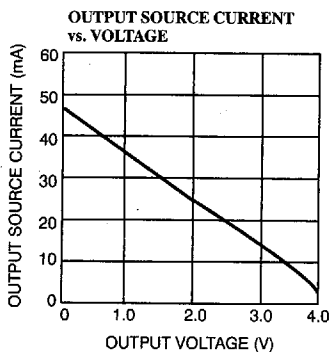
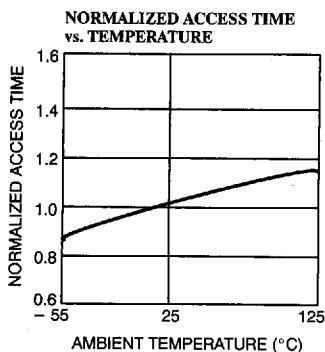
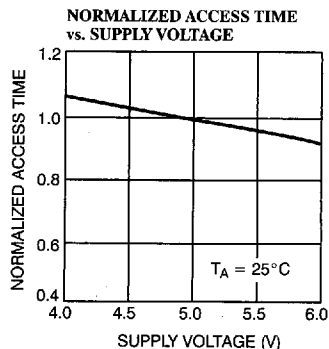
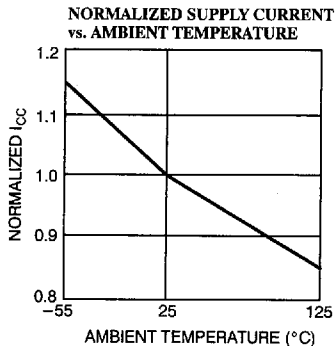
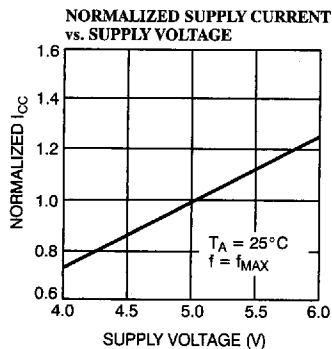
Typical DC and AC Characteristics

Ordering Information^[7]

Speed (ns)	Ordering Code	Package Name	Package Type	Operating Range
20	CY7C243-20JC	J64	28-Lead Plastic Leaded Chip Carrier	Commercial
	CY7C243-20PC	P13	24-Lead (300-Mil) Molded DIP	
	CY7C243-20WC	W14	24-Lead (300-Mil) Windowed CerDIP	
25	CY7C243-25JC	J64	28-Lead Plastic Leaded Chip Carrier	Commercial
	CY7C243-25PC	P13	24-Lead (300-Mil) Molded DIP	
	CY7C243-25WC	W14	24-Lead (300-Mil) Windowed CerDIP	
	CY7C243-25DMB	D14	24-Lead (300-Mil) CerDIP	Military
	CY7C243-25LMB	L64	28-Square Leadless Chip Carrier	
	CY7C243-25QMB	Q64	28-Pin Windowed Leadless Chip Carrier	
	CY7C243-25WMB	W14	24-Lead (300-Mil) Windowed CerDIP	
35	CY7C243-35JC	J64	28-Lead Plastic Leaded Chip Carrier	Commercial
	CY7C243-35PC	P13	24-Lead (300-Mil) Molded DIP	
	CY7C243-35WC	W14	24-Lead (300-Mil) Windowed CerDIP	
	CY7C243-35DMB	D14	24-Lead (300-Mil) CerDIP	Military
	CY7C243-35LMB	L64	28-Square Leadless Chip Carrier	
	CY7C243-35QMB	Q64	28-Pin Windowed Leadless Chip Carrier	
	CY7C243-35WMB	W14	24-Lead (300-Mil) Windowed CerDIP	
45	CY7C243-45JC	J64	28-Lead Plastic Leaded Chip Carrier	Commercial
	CY7C243-45PC	P13	24-Lead (300-Mil) Molded DIP	
	CY7C243-45WC	W14	24-Lead (300-Mil) Windowed CerDIP	
	CY7C243-45DMB	D14	24-Lead (300-Mil) CerDIP	Military
	CY7C243-45LMB	L64	28-Square Leadless Chip Carrier	
	CY7C243-45QMB	Q64	28-Pin Windowed Leadless Chip Carrier	
	CY7C243-45WMB	W14	24-Lead (300-Mil) Windowed CerDIP	
55	CY7C243-55JC	J64	28-Lead Plastic Leaded Chip Carrier	Commercial
	CY7C243-55PC	P13	24-Lead (300-Mil) Molded DIP	
	CY7C243-55WC	W14	24-Lead (300-Mil) Windowed CerDIP	
	CY7C243-55DMB	D14	24-Lead (300-Mil) CerDIP	Military
	CY7C243-55LMB	L64	28-Square Leadless Chip Carrier	
	CY7C243-55QMB	Q64	28-Pin Windowed Leadless Chip Carrier	
	CY7C243-55WMB	W14	24-Lead (300-Mil) Windowed CerDIP	

Note:

7. Most of these products are available in industrial temperature range. Contact a Cypress representative for specifications and product availability.



Ordering Information (continued)^[7]

Speed (ns)	Ordering Code	Package Name	Package Type	Operating Range
20	CY7C244-20PC	P11	24-Lead (600-Mil) Molded DIP	Commercial
	CY7C244-20WC	W12	24-Lead (600-Mil) Windowed CerDIP	
25	CY7C244-25PC	P11	24-Lead (600-Mil) Molded DIP	Commercial
	CY7C244-25WC	W12	24-Lead (600-Mil) Windowed CerDIP	
	CY7C244-25DMB	D12	24-Lead (600-Mil) CerDIP	Military
	CY7C244-25WMB	W12	24-Lead (600-Mil) Windowed CerDIP	
35	CY7C244-35PC	P11	24-Lead (600-Mil) Molded DIP	Commercial
	CY7C244-35WC	W12	24-Lead (600-Mil) Windowed CerDIP	
	CY7C244-35DMB	D12	24-Lead (600-Mil) CerDIP	Military
	CY7C244-35WMB	W12	24-Lead (600-Mil) Windowed CerDIP	
45	CY7C244-45PC	P11	24-Lead (600-Mil) Molded DIP	Commercial
	CY7C244-45WC	W12	24-Lead (600-Mil) Windowed CerDIP	
	CY7C244-45DMB	D12	24-Lead (600-Mil) CerDIP	Military
	CY7C244-45WMB	W12	24-Lead (600-Mil) Windowed CerDIP	
55	CY7C244-55PC	P11	24-Lead (600-Mil) Molded DIP	Commercial
	CY7C244-55WC	W12	24-Lead (600-Mil) Windowed CerDIP	
	CY7C244-55DMB	D12	24-Lead (600-Mil) CerDIP	Military
	CY7C244-55WMB	W12	24-Lead (600-Mil) Windowed CerDIP	

MILITARY SPECIFICATIONS
Group A Subgroup Testing

DC Characteristics

Parameter	Subgroups
V _{OH}	1, 2, 3
V _{OL}	1, 2, 3
V _{IH}	1, 2, 3
V _{IL}	1, 2, 3
I _{Ix}	1, 2, 3
I _{OZ}	1, 2, 3
I _{CC}	1, 2, 3

Switching Characteristics

Parameter	Subgroups
t _{AA}	7, 8, 9, 10, 11
t _{ACS}	7, 8, 9, 10, 11

Document #: 38-00360-A