

## 8MHz, Precision, JFET Input Operational Amplifier

November 1996

### Features

- Low Offset Voltage ..... 100 $\mu$ V
- Low Offset Voltage Drift ..... 2 $\mu$ V/ $^{\circ}$ C
- Low Noise ..... 10nV/ $\sqrt{\text{Hz}}$
- High Open Loop Gain ..... 600kV/V
- Wide Bandwidth ..... 8MHz
- Unity Gain Stable

### Applications

- High Gain Instrumentation Amplifiers
- Precision Data Acquisition
- Precision Integrators
- Precision Threshold Detectors
- For Further Design Ideas, Refer to Application Note 540

### Ordering Information

| PART NUMBER | TEMP. RANGE ( $^{\circ}$ C) | PACKAGE         | PKG. NO. |
|-------------|-----------------------------|-----------------|----------|
| HA2-5170-2  | -55 to 125                  | 8 Pin Metal Can | T8.C     |
| HA2-5170-5  | 0 to 75                     | 8 Pin Metal Can | T8.C     |
| HA7-5170-2  | -55 to 125                  | 8 Ld CERDIP     | F8.3A    |
| HA7-5170-5  | 0 to 75                     | 8 Ld CERDIP     | F8.3A    |

### Description

The Harris HA-5170 is a precision, JFET input, operational amplifier which features low noise, low offset voltage and low offset voltage drift. Constructed using FET/Bipolar technology, the Harris Dielectric Isolation (DI) process, and laser trimming this amplifier offers low input bias and offset currents. This operational amplifier design also completely eliminates the troublesome errors due to warm-up drift.

Complementing these excellent input characteristics are dynamic performance characteristics never before available from precision operational amplifiers. An 8V/ $\mu$ s slew rate and 8MHz bandwidth allow the designer to extend precision instrumentation applications in both speed and bandwidth. These characteristics make the HA-5170 well suited for precision integrator amplifier designs.

The superior input characteristics also make the HA-5170 ideally suited for transducer signal amplifiers, precision voltage followers and precision data acquisition systems. For application assistance, please refer to Application Note AN540 addressing specifically this device.

Military version (-8) product and data sheets available upon request.

**3**  
**OPERATIONAL AMPLIFIERS**

### Pinouts

HA-5170  
(CERDIP)  
TOP VIEW

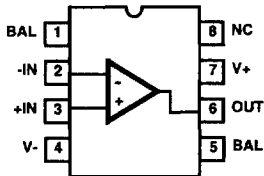

HA-5170  
(METAL CAN)  
TOP VIEW

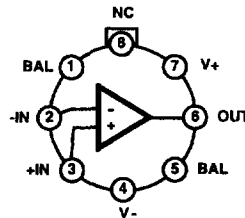

# HA-5170

## Absolute Maximum Ratings

|                                     |            |
|-------------------------------------|------------|
| Voltage Between V+ and V- Terminals | 44V        |
| Differential Input Voltage          | 30V        |
| Output Short Circuit Duration       | Indefinite |

## Thermal Information

|  |                      |                      |
|--|----------------------|----------------------|
| Thermal Resistance (Typical, Note 1)     | $\theta_{JA}$ (°C/W) | $\theta_{JC}$ (°C/W) |
| CERDIP Package                           | 135                  | 50                   |
| Metal Can Package                        | 155                  | 67                   |
| Maximum Junction Temperature             | 175°C                |                      |
| Maximum Storage Temperature Range        | -65°C to 150°C       |                      |
| Maximum Lead Temperature (Soldering 10s) | 300°C                |                      |

## Operating Conditions

|                   |                |
|-------------------|----------------|
| Temperature Range |                |
| HA-5170-2         | -55°C to 125°C |
| HA-5170-5         | 0°C to 75°C    |

*CAUTION: Stresses above those listed in "Absolute Maximum Ratings" may cause permanent damage to the device. This is a stress only rating and operation of the device at these or any other conditions above those indicated in the operational sections of this specification is not implied.*

### NOTE:

- $\theta_{JA}$  is measured with the component mounted on an evaluation PC board in free air.

## Electrical Specifications $V_{SUPPLY} = \pm 15V$ , Unless Otherwise Specified

| PARAMETER                              | TEST CONDITIONS | TEMP. (°C) | HA-5170-2<br>-55°C to 125°C |                    |     | HA-5170-5<br>0°C to 75°C |                    |     | UNITS            |
|--|-----------------|------------|-----------------------------|--------------------|-----|--------------------------|--------------------|-----|------------------|
|  |                 |            | MIN                         | TYP                | MAX | MIN                      | TYP                | MAX |                  |
| <b>INPUT CHARACTERISTICS</b>           |                 |            |                             |                    |     |                          |                    |     |                  |
| Offset Voltage                         |                 | 25         | -                           | 0.1                | 0.3 | -                        | 0.1                | 0.3 | mV               |
|  |                 | Full       | -                           | -                  | 0.5 | -                        | -                  | 0.5 | mV               |
| Average Offset Voltage Drift (Note 3)  |                 | Full       | -                           | 2                  | 5   | -                        | 2                  | 5   | $\mu V/^\circ C$ |
| Bias Current                           |                 | 25         | -                           | 20                 | 100 | -                        | 20                 | 100 | pA               |
|  |                 | Full       | -                           | 3                  | 30  | -                        | 0.1                | 2   | nA               |
| Bias Current Average Drift             |                 | Full       | -                           | 3                  | -   | -                        | 3                  | -   | $pA/^\circ C$    |
| Offset Current                         |                 | 25         | -                           | 3                  | 30  | -                        | 3                  | 60  | pA               |
|  |                 | Full       | -                           | -                  | 5   | -                        | -                  | 0.1 | nA               |
| Offset Current Average Drift (Note 3)  |                 | Full       | -                           | 0.3                | 1   | -                        | 0.3                | 1   | $pA/^\circ C$    |
| Common Mode Range                      |                 | Full       | $\pm 10$                    | +15.1              | -   | $\pm 10$                 | +15.1              | -   | V                |
|  |                 | Full       |                             | -12                | -   | -                        | -12                | -   | V                |
| Differential Input Capacitance         |                 | 25         | -                           | 80                 | 100 | -                        | 80                 | 100 | pF               |
| Differential Input Resistance (Note 3) |                 | 25         | $1 \times 10^{10}$          | $6 \times 10^{10}$ | -   | $1 \times 10^{10}$       | $6 \times 10^{10}$ | -   | $\Omega$         |
| Input Capacitance (Single Ended)       |                 | 25         | -                           | 12                 | -   | -                        | 12                 | -   | pF               |
| Input Noise Voltage (Note 3)           | 0.1Hz to 10Hz   | 25         | -                           | 0.5                | 5   | -                        | 0.5                | 5   | $\mu V_{p-p}$    |
| Input Noise Voltage Density (Note 3)   | f = 10Hz        | 25         | -                           | 20                 | 150 | -                        | 20                 | 150 | $nV/\sqrt{Hz}$   |
|  | f = 100Hz       | 25         | -                           | 12                 | 50  | -                        | 12                 | 50  | $nV/\sqrt{Hz}$   |
|  | f = 1000Hz      | 25         | -                           | 10                 | 25  | -                        | 10                 | 25  | $nV/\sqrt{Hz}$   |
| Input Noise Current Density (Note 3)   | f = 10Hz        | 25         | -                           | 0.05               | -   | -                        | 0.05               | -   | $pA/\sqrt{Hz}$   |
|  | f = 100Hz       | 25         | -                           | 0.01               | -   | -                        | 0.01               | -   | $pA/\sqrt{Hz}$   |
|  | f = 1000Hz      | 25         | -                           | 0.01               | 0.1 | -                        | 0.01               | 0.1 | $pA/\sqrt{Hz}$   |

# HA-5170

## Electrical Specifications $V_{SUPPLY} = \pm 15V$ , Unless Otherwise Specified (Continued)

| PARAMETER                             | TEST CONDITIONS                           | TEMP. (°C) | HA-5170-2<br>-55°C to 125°C |          |     | HA-5170-5<br>0°C to 75°C |          |     | UNITS      |
|---------------------------------------|---|------------|-----------------------------|----------|-----|--------------------------|----------|-----|------------|
|                                       |   |            | MIN                         | TYP      | MAX | MIN                      | TYP      | MAX |            |
| <b>TRANSFER CHARACTERISTICS</b>       |   |            |                             |          |     |                          |          |     |            |
| Large Signal Voltage Gain             | $V_{OUT} = \pm 10V$ ,<br>$R_L = 2k\Omega$ | 25         | 300                         | 600      | -   | 300                      | 600      | -   | kV/V       |
|                                       |   | Full       | 200                         | -        | -   | 250                      | -        | -   | kV/V       |
| Common Mode Rejection Ratio           | $\Delta V_{CM} = \pm 10V$                 | Full       | 85                          | 100      | -   | 90                       | 100      | -   | dB         |
| Minimum Stable Gain                   |   | 25         | 1                           | -        | -   | 1                        | -        | -   | V/V        |
| Closed Loop Bandwidth                 | $A_{VCL} = +1$                            | 25         | 4                           | 8        | -   | 4                        | 8        | -   | MHz        |
| <b>OUTPUT CHARACTERISTICS</b>         |   |            |                             |          |     |                          |          |     |            |
| Output Voltage Swing                  | $R_L = 2k\Omega$                          | 25         | $\pm 10$                    | $\pm 12$ | -   | $\pm 10$                 | $\pm 12$ | -   | V          |
| Full Power Bandwidth (Note 4)         | $R_L = 2k\Omega$                          | 25         | 80                          | 120      | -   | 80                       | 120      | -   | kHz        |
| Output Current (Note 5)               | $V_{OUT} = \pm 10V$                       | 25         | $\pm 10$                    | $\pm 15$ | -   | $\pm 10$                 | $\pm 15$ | -   | mA         |
| Output Resistance (Note 3)            | Open Loop, 100Hz                          | 25         | -                           | 45       | 100 | -                        | 45       | 100 | $\Omega$   |
| <b>TRANSIENT RESPONSE</b>             |   |            |                             |          |     |                          |          |     |            |
| Rise Time                             | Note 2                                    | 25         | -                           | 45       | 100 | -                        | 45       | 100 | ns         |
| Slew Rate                             | Note 2                                    | 25         | 5                           | 8        | -   | 5                        | 8        | -   | V/ $\mu s$ |
| Settling Time (Notes 3, 7)            |   | 25         | -                           | 1        | 5   | -                        | 1        | 5   | $\mu s$    |
| <b>POWER SUPPLY CHARACTERISTICS</b>   |   |            |                             |          |     |                          |          |     |            |
| Supply Current                        |   | Full       | -                           | 1.9      | 2.5 | -                        | 1.9      | 2.5 | mA         |
| Power Supply Rejection Ratio (Note 8) |   | Full       | 85                          | 105      | -   | 90                       | 105      | -   | dB         |

**NOTES:**

2. See "Test Circuits and Waveforms" section.
3. Parameter is not 100% tested. 90% of all units meet or exceed these specifications.
4. Full power bandwidth guaranteed based on slew rate measurement using:  $FPBW = \frac{\text{Slew Rate}}{2\pi V_{PEAK}}$ .
5.  $I_{SC}$  turns on at  $\approx 23mA$ .
6. Settling time is measured to 0.1% of final value for a 10V output step and  $A_V = -1$ .
7.  $V_+ = +15V$ ,  $V_- = -10V$  to  $-20V$  and  $V_- = -15V$ ,  $V_+ = +10V$  to  $+20V$ .

**3**  
OPERATIONAL  
AMPLIFIERS

**Test Circuits and Waveforms**

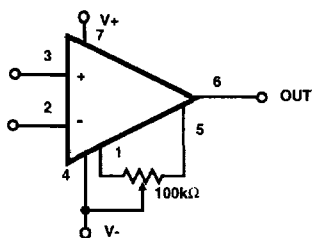

Tested Offset Adjustment Range is  $IV_{OS} + 1mV$  minimum referred to output. Typical range is  $\pm 5mV$  with  $R_T = 1k\Omega$  and  $\pm 15mV$  with  $R_T = 100k\Omega$ .

**FIGURE 1.  $V_{OS}$  ADJUSTMENT**

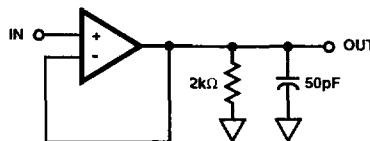

**FIGURE 2. LARGE AND SMALL SIGNAL RESPONSE CIRCUIT**



Vertical Scale: 5V/Div.  
Horizontal Scale: 1μs/Div.

**LARGE SIGNAL RESPONSE**



Vertical Scale: 10mV/Div.  
Horizontal Scale: 100ns/Div.

**SMALL SIGNAL RESPONSE**

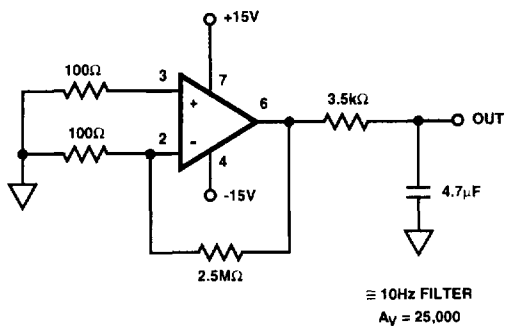

**FIGURE 3. LOW FREQUENCY NOISE TEST CIRCUIT**

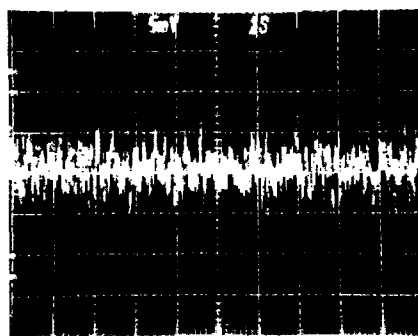

Vertical Scale: 200nV/Div. (Noise Referred to Input)  
5mV/Div. at Output,  $A_{VCL} = 25,000$   
Horizontal Scale: 1s/Div.

**HA-5170 LOW FREQUENCY NOISE (0.1Hz TO 10Hz)**

Schematic Diagram

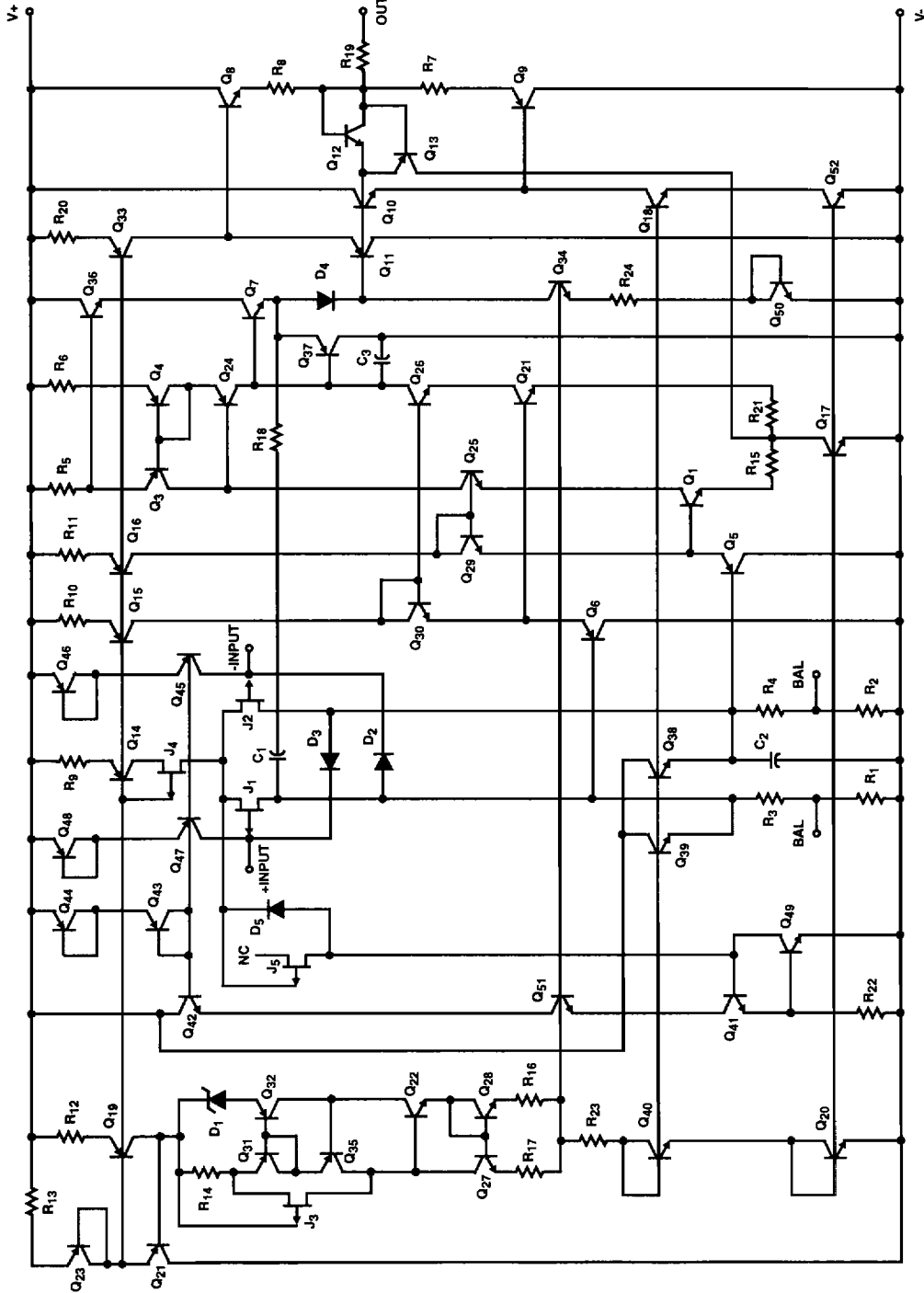

Typical Performance Curves

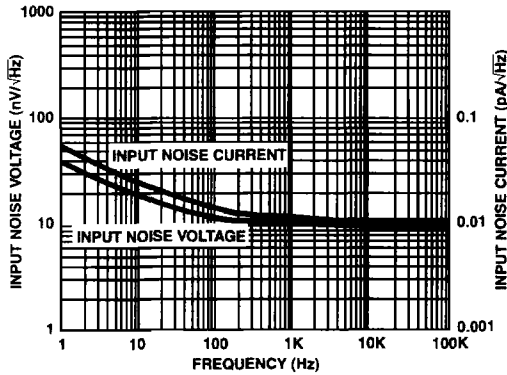

FIGURE 4. INPUT NOISE vs FREQUENCY

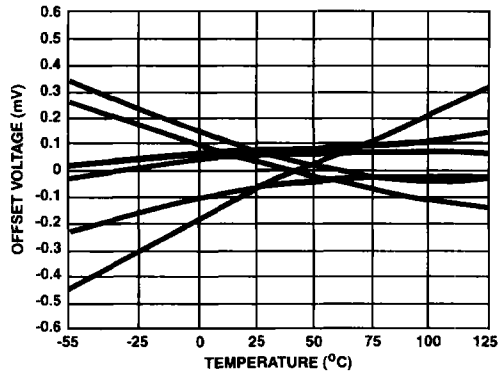

FIGURE 5. OFFSET VOLTAGE DRIFT vs TEMPERATURE OF REPRESENTATIVE UNITS

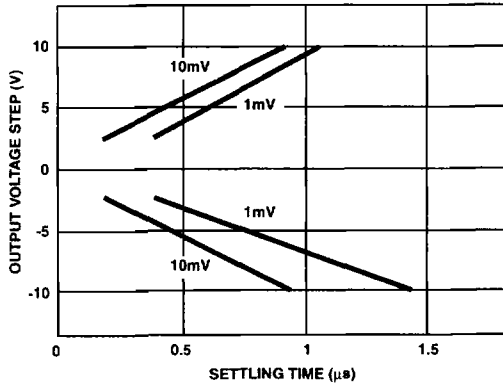

FIGURE 6. SETTLING TIME FOR VARIOUS OUTPUT STEP VOLTAGES

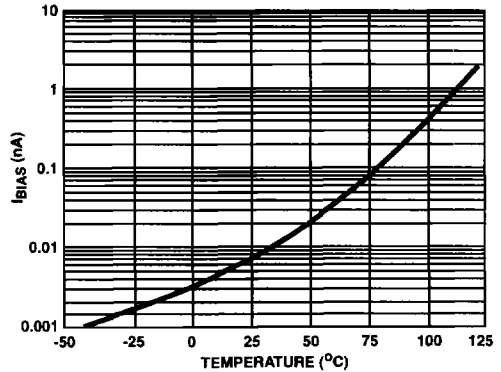

FIGURE 7. BIAS CURRENT vs TEMPERATURE

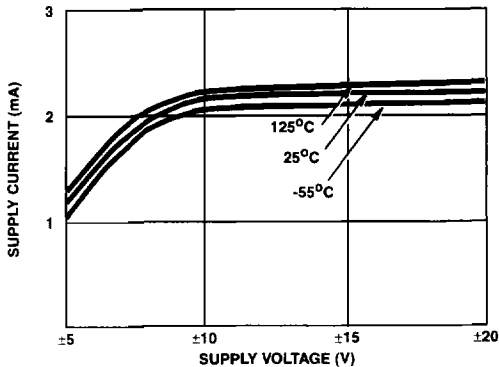

FIGURE 8. POWER SUPPLY CURRENT vs SUPPLY VOLTAGE

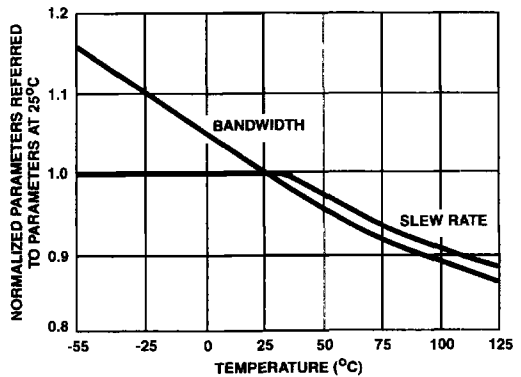

FIGURE 9. NORMALIZED AC PARAMETERS vs TEMPERATURE

Typical Performance Curves (Continued)

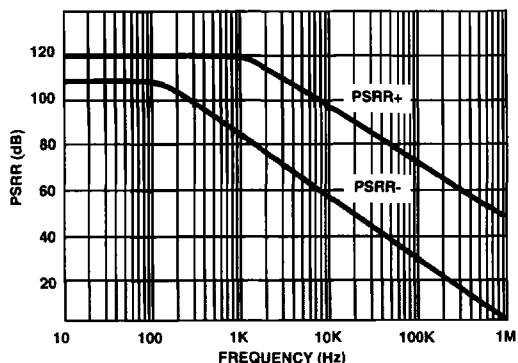

FIGURE 10. POWER SUPPLY REJECTION RATIO vs FREQUENCY

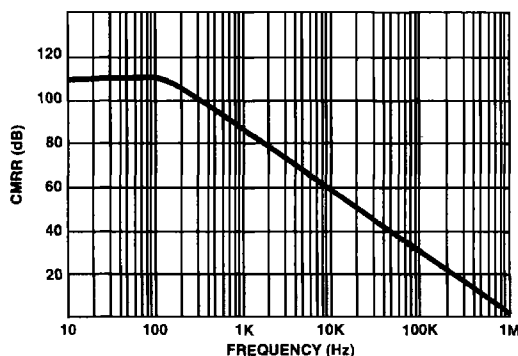

FIGURE 11. COMMON MODE REJECTION RATIO vs FREQUENCY

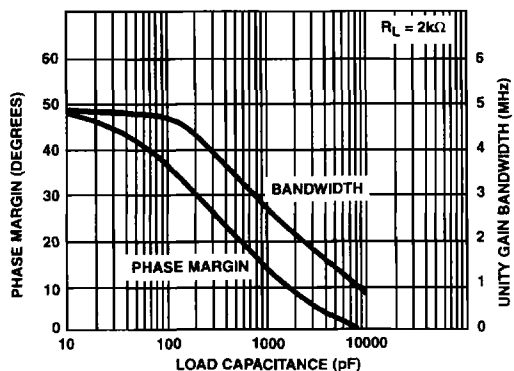

FIGURE 12. SMALL SIGNAL BANDWIDTH AND PHASE MARGIN vs LOAD CAPACITANCE

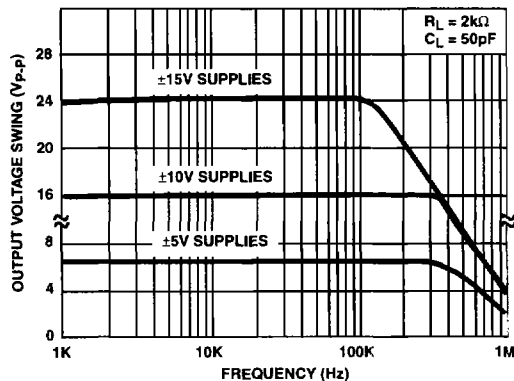

FIGURE 13. OUTPUT VOLTAGE SWING vs FREQUENCY AND SUPPLY VOLTAGE

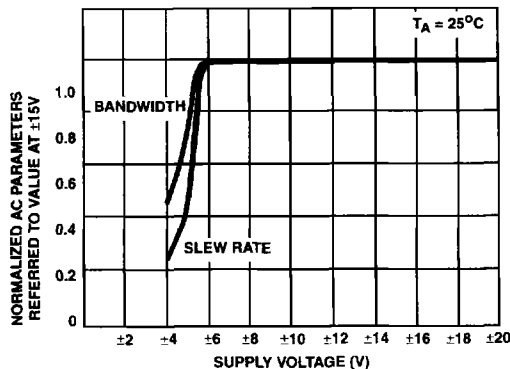

FIGURE 14. NORMALIZED AC PARAMETERS vs SUPPLY VOLTAGE

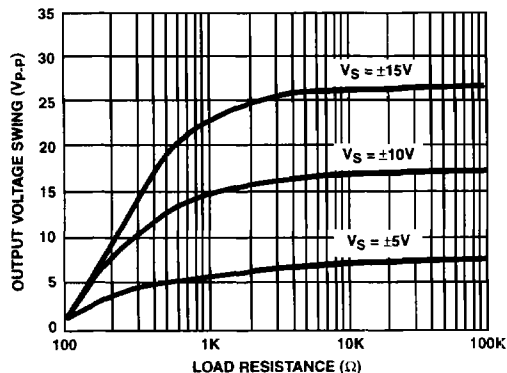

FIGURE 15. MAXIMUM OUTPUT VOLTAGE SWING vs LOAD RESISTANCE

Typical Performance Curves (Continued)

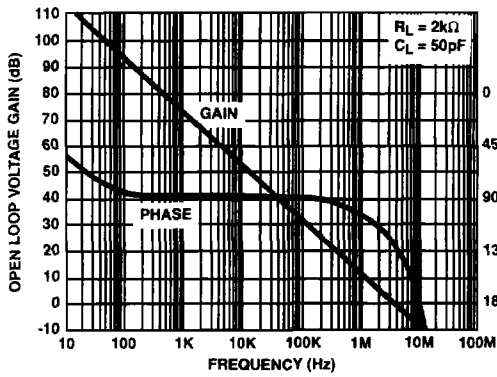

FIGURE 16. OPEN LOOP FREQUENCY RESPONSE

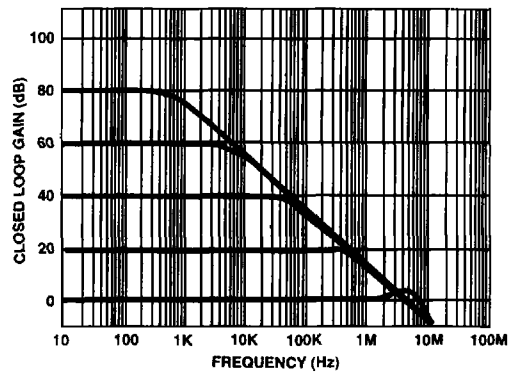

FIGURE 17. CLOSED LOOP FREQUENCY RESPONSE FOR VARIOUS CLOSED LOOP GAINS