

FAN7171_F085 High-Current High-Side Gate Drive IC

Features

- Floating Channel for Bootstrap Operation to +600V
- 4A/4A Sourcing/Sinking Current Driving Capability
- Common-Mode dv/dt Noise Canceling Circuit
- 3.3V and 5V Input Logic Compatible
- Output In-phase with Input Signal
- Under- Voltage Lockout for V_{BS}
- 25V Shunt Regulator on V_{DD} and V_{BS}
- 8-Lead Small Outline Package (SOP)
- Qualified to AEC Q100

Applications

- High-Speed Gate Driver
- High-Power Buck Converter
- Motor Drive Inverter

Description

The FAN7171_F085 is a monolithic high-side gate drive IC, which can drive high-speed MOSFETs and IGBTs that operate up to +600V. It has a buffered output stage with all NMOS transistors designed for high pulse current driving capability and minimum cross-conduction.

Fairchild's high-voltage process and common-mode noise canceling techniques provide stable operation of the high-side driver under high dv/dt noise circumstances. An advanced level-shift circuit offers high-side gate driver operation up to $V_S = -9.8V$ (typical) for $V_{BS} = 15V$.

The UVLO circuit prevents malfunction when V_{BS} is lower than the specified threshold voltage.

The high-current and low-output voltage drop feature makes this device suitable for sustaine switch driver and energy recovery switch driver in the Plasma Display Panel application, motor drive inverter, switching power supply, and high-power DC-DC converter applications.

8-SOP



Ordering Information

Part Number	Package	Operating Temperature Range	 Eco Status	Packing Method
FAN7171M ⁽¹⁾	8-SOP	-40°C ~ 125°C	RoHS	Tube
FAN7171MX ⁽¹⁾				Tape & Reel

Note:

1. These devices passed wave soldering test by JESD22A-111.



For Fairchild's definition of "green" Eco Status, please visit: http://www.fairchildsemi.com/company/green/rohs_green.html.

Typical Application Diagrams

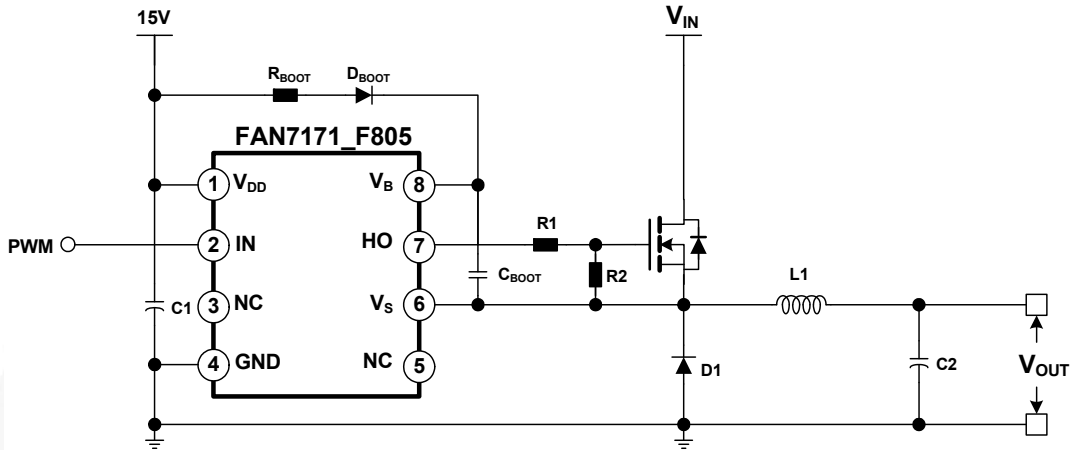

Figure 1. Application Circuit for Step-Down (Buck) DC-DC Converter

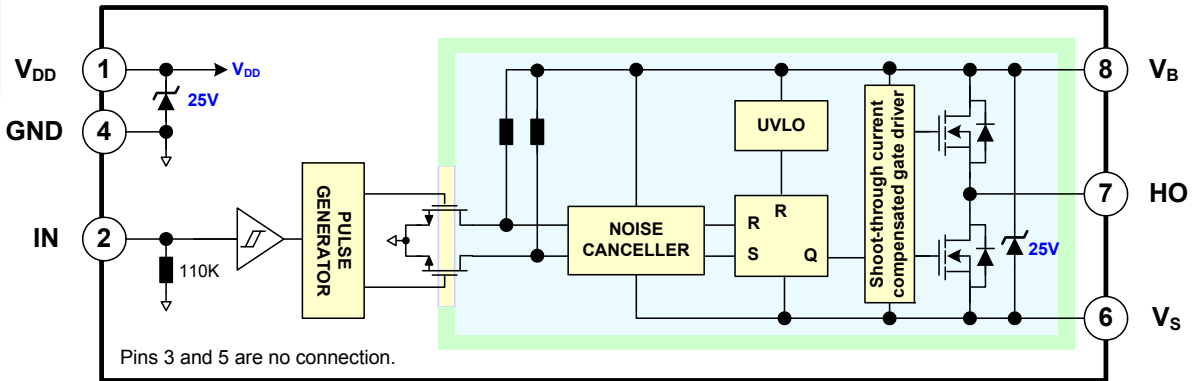

Figure 2. Functional Block Diagram

Pin Configuration

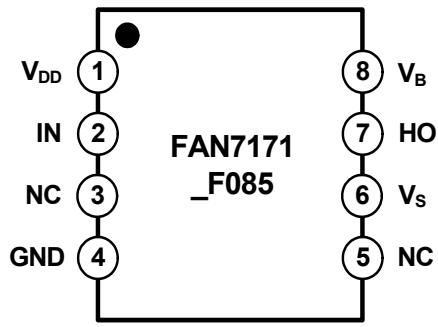

Figure 3. Pin Assignments(Top View)

Pin Definitions

Pin #	Name	Description
1	V _{DD}	Supply Voltage
2	IN	Logic Input for High-Side Gate Driver Output
3	NC	No Connection
4	GND	Ground
5	NC	No Connection
6	V _S	High-Voltage Floating Supply Return
7	HO	High-Side Driver Output
8	V _B	High-Side Floating Supply

Absolute Maximum Ratings

Stresses exceeding the absolute maximum ratings may damage the device. The device may not function or be operable above the recommended operating conditions and stressing the parts to these levels is not recommended. In addition, extended exposure to stresses above the recommended operating conditions may affect device reliability. The absolute maximum ratings are stress ratings only. $-40^{\circ}\text{C} \leq T_A \leq 125^{\circ}\text{C}$ unless otherwise specified.

Symbol	Characteristics	Min.	Max.	Unit
V_S	High-Side Floating Offset Voltage	$V_B - V_{SHUNT}$	$V_B + 0.3$	V
V_B	High-Side Floating Supply Voltage ⁽²⁾	-0.3	625.0	V
V_{HO}	High-Side Floating Output Voltage	$V_S - 0.3$	$V_B + 0.3$	V
V_{DD}	Low-Side and Logic Supply Voltage ⁽²⁾	-0.3	V_{SHUNT}	V
V_{IN}	Logic Input Voltage	-0.3	$V_{DD} + 0.3$	V
dV_S/dt	Allowable Offset Voltage Slew Rate		± 50	V/ns
P_D	Power Dissipation ^(3, 4, 5)		0.625	W
θ_{JA}	Thermal Resistance		200	$^{\circ}\text{C}/\text{W}$
T_J	Junction Temperature	-55	150	$^{\circ}\text{C}$
T_{STG}	Storage Temperature	-55	150	$^{\circ}\text{C}$
T_A	Operating Ambient Temperature	-40	125	$^{\circ}\text{C}$
V_{ESD}	Human Body Model(HBM)		1500	V
V_{CDM}	Charge Device Model		500	V

Notes:

- This IC contains a shunt regulator on VDD and VBS with a normal breakdown voltage of 25V. Please note that this supply pin should not be driven by a low-impedance voltage source greater than the VSHUNT specified in the Electrical Characteristics section
- Mounted on 76.2 x 114.3 x 1.6mm PCB (FR-4 glass epoxy material).
- Refer to the following standards:
JESD51-2: Integral circuits thermal test method environmental conditions, natural convection, and
JESD51-3: Low effective thermal conductivity test board for leaded surface mount packages.
- Do not exceed power dissipation (P_D) under any circumstances.

Recommended Operating Conditions

The Recommended Operating Conditions table defines the conditions for actual device operation. Recommended operating conditions are specified to ensure optimal performance to the datasheet specifications. Fairchild does not recommend exceeding them or designing to absolute maximum ratings.

Symbol	Parameter	Min.	Max.	Unit
V_{BS}	High-Side Floating Supply Voltage	$V_S + 10$	$V_S + 20$	V
V_S	High-Side Floating Supply Offset Voltage(DC)	$6 - V_{DD}$	600	V
V_S	High-Side Floating Supply Offset Voltage(Transient)	-15(~170) -7(~400)	600	V
V_{HO}	High-Side Output Voltage	V_S	V_B	V
V_{IN}	Logic Input Voltage	GND	V_{DD}	V
V_{DD}	Supply Voltage	10	20	V

Electrical Characteristics

$V_{BIAS}(V_{DD}, V_{BS})=15.0V$, $-40^{\circ}C \leq T_A \leq 125^{\circ}C$, unless otherwise specified. The V_{IN} and I_{IN} parameters are referenced to GND. The V_O and I_O parameters are relative to V_S and are applicable to the respective output HO.

Symbol	Characteristics	Test Condition	Min.	Typ.	Max.	Unit
POWER SUPPLY SECTION						
I_{QDD}	Quiescent V_{DD} Supply Current	$V_{IN}=0V$ or $5V$		25	70	μA
I_{PDD}	Operating V_{DD} Supply Current	$f_{IN}=20KHz$, No Load		35	100	μA
BOOTSTRAPPED SUPPLY SECTION						
V_{BSUV+}	V_{BS} Supply Under-Voltage Positive Going Threshold Voltage	$V_{BS}=\text{Sweep}$	8.2	9.2	10.2	V
V_{BSUV-}	V_{BS} Supply Under-Voltage Negative Going Threshold Voltage	$V_{BS}=\text{Sweep}$	7.5	8.5	9.5	V
V_{BSHYS}	V_{BS} Supply Under-Voltage Lockout Hysteresis Voltage	$V_{BS}=\text{Sweep}$		0.6		V
I_{LK}	Offset Supply Leakage Current	$V_B=V_S=600V$			50	μA
I_{QBS}	Quiescent V_{BS} Supply Current	$V_{IN}=0V$ or $5V$		60	120	μA
I_{PBS}	Operating V_{BS} Supply Current	$C_{LOAD}=1nF$, $f_{IN}=20KHz$, rms value		0.73	2.8	mA
SHUNT REGULATOR SECTION						
V_{SHUNT}	V_{DD} and V_{BS} Shunt Regulator Clamping Voltage	$I_{SHUNT}=5mA$	23	25		V
INPUT LOGIC SECTION(IN)						
V_{IH}	Logic "1" Input Voltage		2.5			V
V_{IL}	Logic "0" Input Voltage				0.8	V
I_{IN+}	Logic Input High Bias Current	$V_{IN}=5V$		45	125	μA
I_{IN-}	Logic Input Low Bias Current	$V_{IN}=0V$			2	μA
R_{IN}	Input Pull-down Resistance		40	110		$K\Omega$
GATE DRIVER OUTPUT SECTION(HO)						
V_{OH}	High Level Output Voltage ($V_{BIAS} - V_O$)	No Load			1.5	V
V_{OL}	Low Level Output Voltage	No Load			35	mV
I_{O+}	Output High, Short-Circuit Pulsed Current ⁽⁵⁾	$V_{HO}=0V$, $V_{IN}=5V$, $PW \leq 10\mu s$	3.0	4.0		A
I_{O-}	Output Low, Short-Circuit Pulsed Current ⁽⁵⁾	$V_{HO}=15V$, $V_{IN}=0V$, $PW \leq 10\mu s$	3.0	4.0		A
V_S	Allowable Negative V_S pin Voltage for IN Signal Propagation to HO			-9.8	-7.0	V

Note:

5 These parameters guaranteed by design.

Dynamic Electrical Characteristics

$V_{BIAS}(V_{DD}, V_{BS})=15V$, $V_S=GND=0V$, $C_L=1000pF$, and $-40^{\circ}C \leq T_A \leq 125^{\circ}C$, unless otherwise specified.

Symbol	Parameter	Conditions	Min.	Typ.	Max.	Unit
t_{on}	Turn-on Propagation Delay Time	$V_S=0V$		150	210	ns
t_{off}	Turn-off Propagation Delay Time	$V_S=0V$		150	210	ns
t_r	Turn-on Rise Time			25	50	ns
t_f	Turn-off Fall Time			15	45	ns

Typical Characteristics

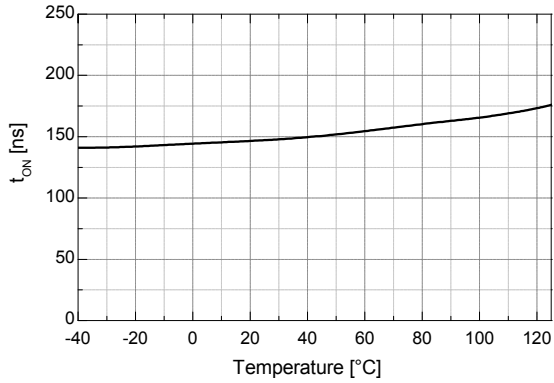

Figure 4. Turn-on Propagation Delay vs. Temperature

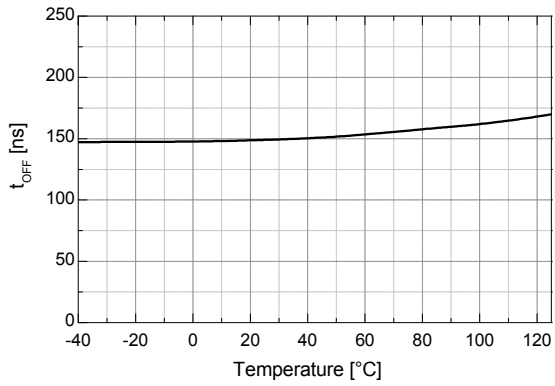

Figure 5. Turn-off Propagation Delay vs. Temperature

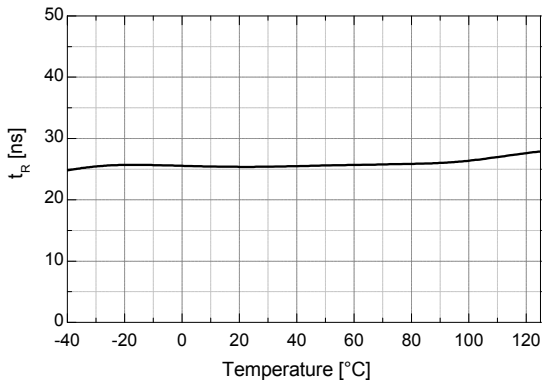

Figure 6. Turn-on Rise Time vs. Temperature

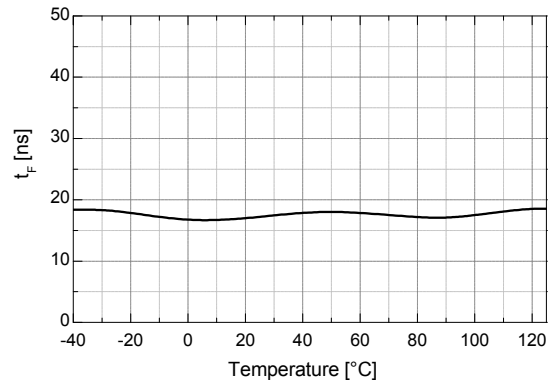

Figure 7. Turn-off Fall Time vs. Temperature

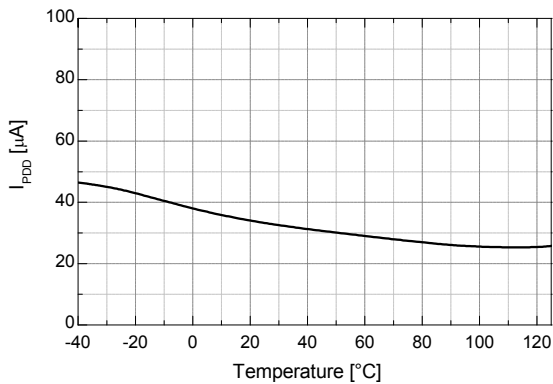

Figure 8. Operating V_{DD} Supply Current vs. Temperature

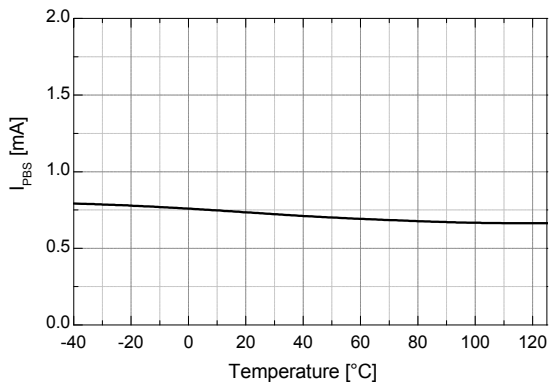

Figure 9. Operating V_{BS} Supply Current vs. Temperature

Typical Characteristics (Continued)

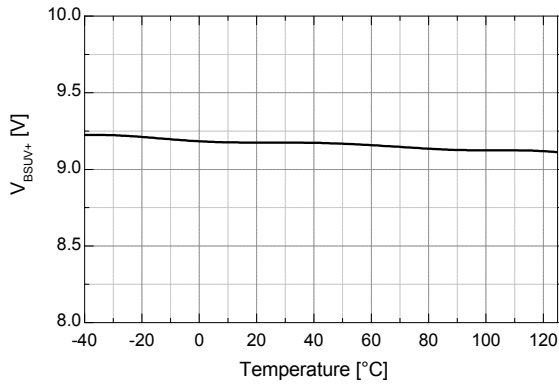

Figure 10. $V_{BS\ UVLO+}$ vs. Temperature

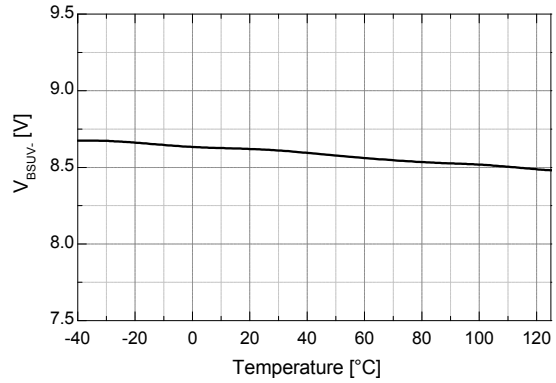

Figure 11. $V_{BS\ UVLO-}$ vs. Temperature

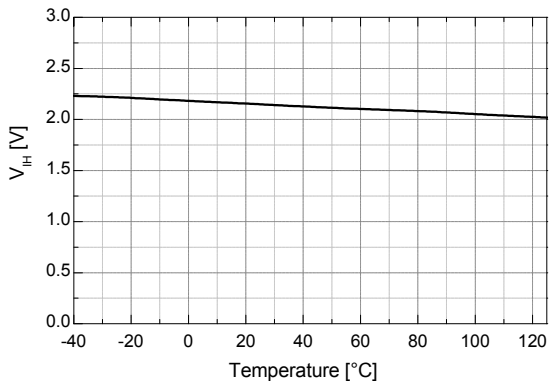

Figure 12. Logic High Input Voltage vs. Temperature

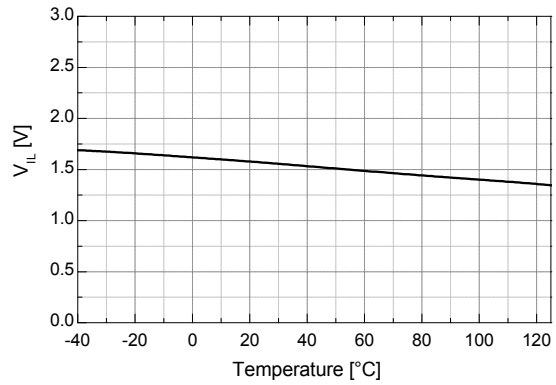

Figure 13. Logic Low Input Voltage vs. Temperature

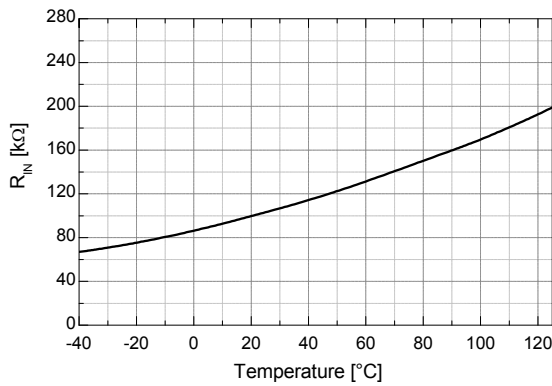

Figure 14. Input Pull-down Resistance vs. Temperature.

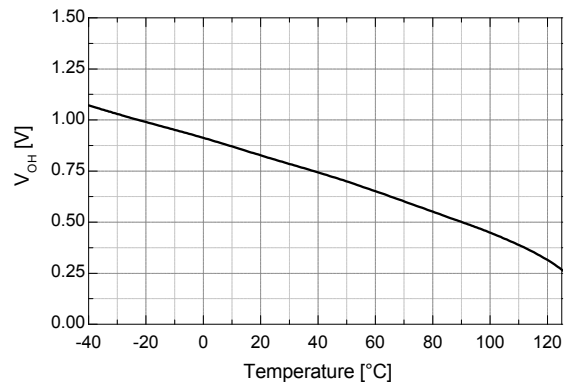

Figure 15. High-Level Output Voltage vs. Temperature

Typical Characteristics (Continued)

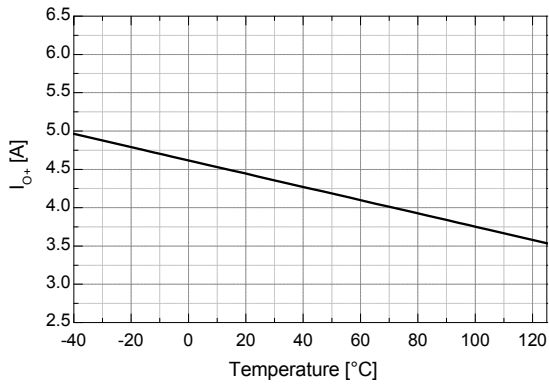

Figure 16. Output High, Short-Circuit Pulsed Current vs. Temperature

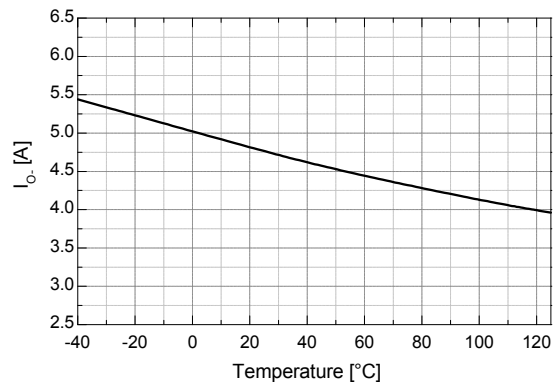

Figure 17. Output Low, Short-Circuit Pulsed Current vs. Temperature

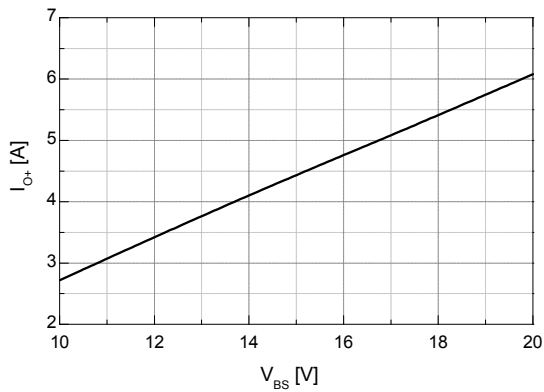

Figure 18. Output High, Short-Circuit Pulsed Current vs. Supply Voltage

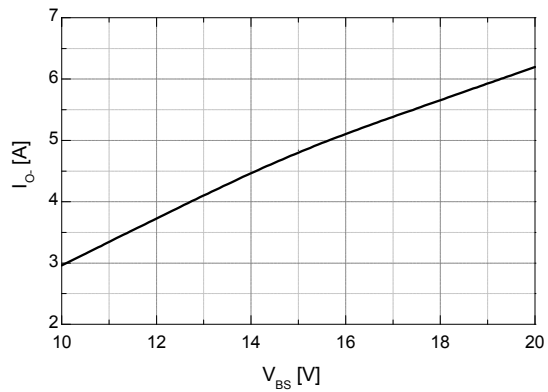

Figure 19. Output Low, Short-Circuit Pulsed Current vs. Supply Voltage

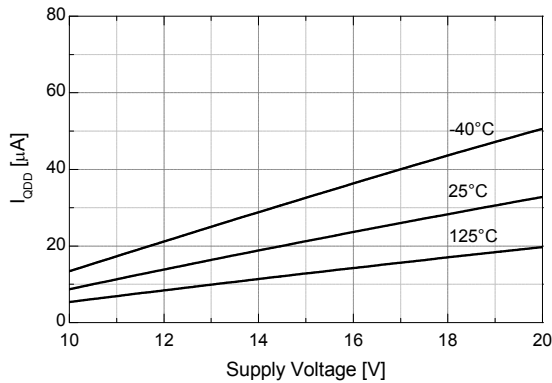

Figure 20. Quiescent V_{DD} Supply Current vs. Supply Voltage

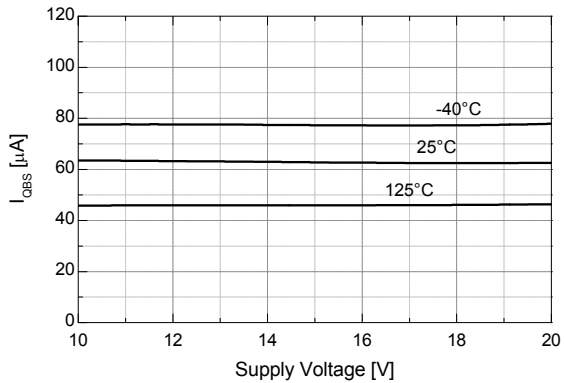

Figure 21. Quiescent V_{BS} Supply Current vs. Supply Voltage

Switching Time Definitions

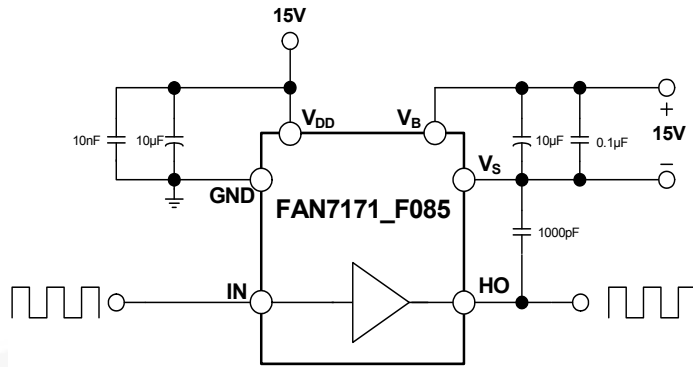

Figure 22. Switching Time Test Circuit (Referenced 8-SOP)

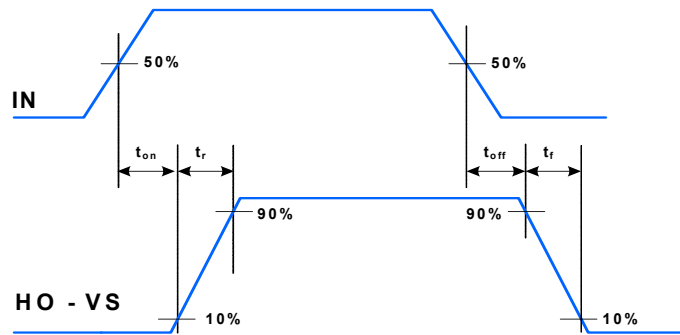

Figure 23. Switching Time Waveform Definitions

Physical Dimensions

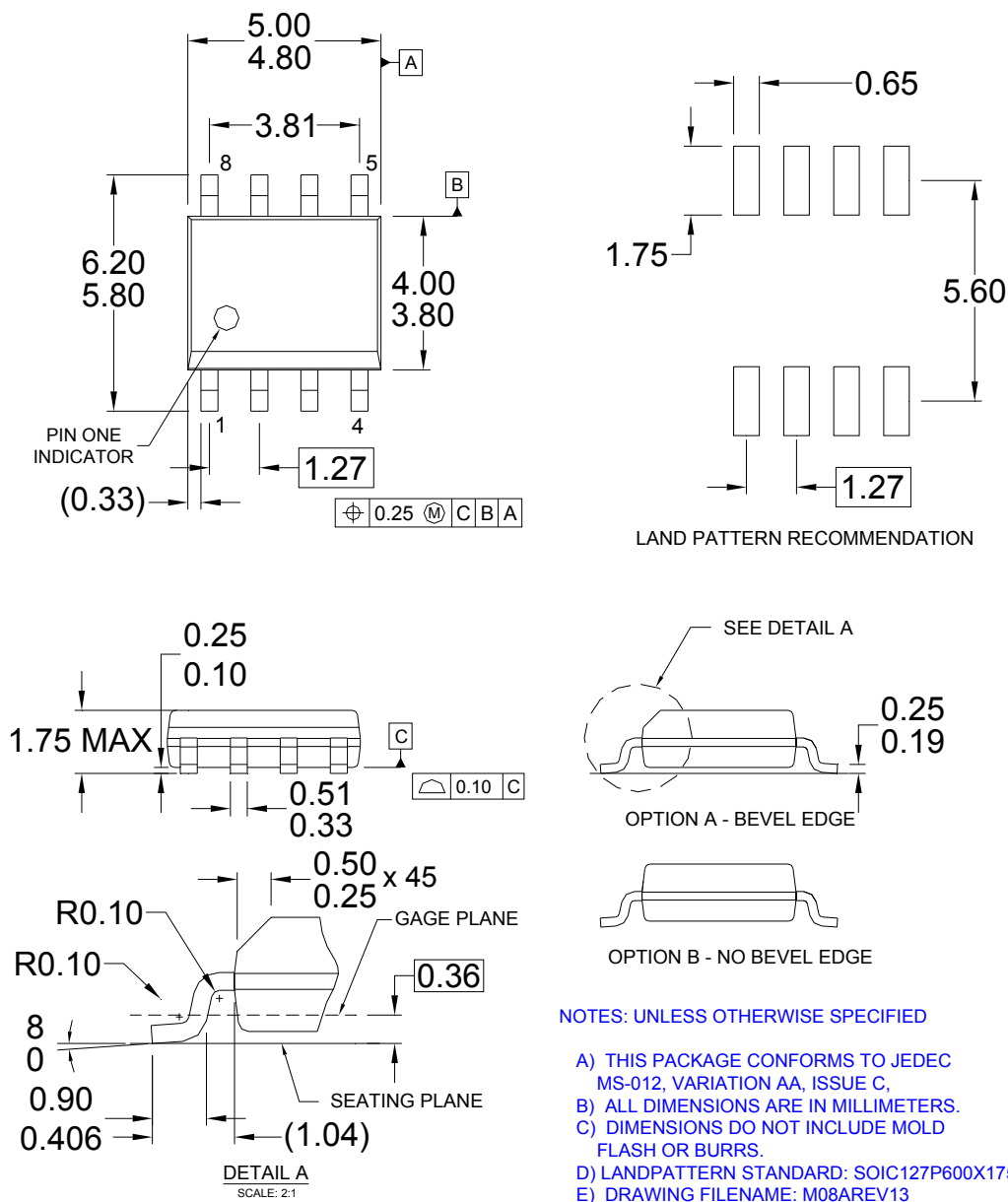

Figure 24. 8-Lead Small Outline Package (SOP)

Package drawings are provided as a service to customers considering Fairchild components. Drawings may change in any manner without notice. Please note the revision and/or date on the drawing and contact a Fairchild Semiconductor representative to verify or obtain the most recent revision. Package specifications do not expand the terms of Fairchild's worldwide terms and conditions, specifically the warranty therein, which covers Fairchild products.







Always visit Fairchild Semiconductor's online packaging area for the most recent package drawings:

<http://www.fairchildsemi.com/packaging/>



TRADEMARKS

The following includes registered and unregistered trademarks and service marks, owned by Fairchild Semiconductor and/or its global subsidiaries, and is not intended to be an exhaustive list of all such trademarks.

- | | | | |
|---|---|---|--|
| AccuPower™ | FlashWriter®* | Power-SPM™ |  SYSTEM GENERAL
The Power Franchise®
 the power franchise
TinyBoost™
TinyBuck™
TinyCalc™
TinyLogic®
TINYOPTO™
TinyPower™
TinyPWM™
TinyWire™
TriFault Detect™
TRUECURRENT™*
μSerDes™
 SerDes®
UHC®
Ultra FRFET™
UniFET™
VCX™
VisualMax™
XS™ |
| Auto-SPM™ | FP5™ | PowerTrench® | |
| Build it Now™ | F-PFS™ | PowerXS™ | |
| CorePLUS™ | FRFET® | Programmable Active Droop™ | |
| CorePOWER™ | Global Power Resource SM | QFET® | |
| CROSSVOLT™ | Green FP5™ | Q5™ | |
| CTL™ | Green FP5™ e-Series™ | Quiet Series™ | |
| Current Transfer Logic™ | Gmax™ | RapidConfigure™ | |
| EcoSPARK® | GTO™ |  ™ | |
| EfficientMax™ | IntelliMAX™ | Saving our world, 1mW/W/kW at a time™ | |
| EZSWITCH™* | ISOPLANAR™ | SignalWise™ | |
|  ™** | MegaBuck™ | SmartMax™ | |
| DEUXPEED™ | MICROCOUPLER™ | SMART START™ | |
|  ® | MicroFET™ | SPM® | |
| Fairchild® | MicroPak™ | STEALTH™ | |
| Fairchild Semiconductor® | MillerDrive™ | SuperFET™ | |
| FACT Quiet Series™ | MotionMax™ | SuperSOT™-3 | |
| FACT® | Motion-SPM™ | SuperSOT™-6 | |
| FAST® | OPTOLOGIC® | SuperSOT™-8 | |
| FastvCore™ | OPTOPLANAR® | SupreMOS™ | |
| FETBench™ |  | SyncFET™ | |
| | PDP SPM™ | Sync-Lock™ | |

* Trademarks of System General Corporation, used under license by Fairchild Semiconductor.

DISCLAIMER

FAIRCHILD SEMICONDUCTOR RESERVES THE RIGHT TO MAKE CHANGES WITHOUT FURTHER NOTICE TO ANY PRODUCTS HEREIN TO IMPROVE RELIABILITY, FUNCTION, OR DESIGN. FAIRCHILD DOES NOT ASSUME ANY LIABILITY ARISING OUT OF THE APPLICATION OR USE OF ANY PRODUCT OR CIRCUIT DESCRIBED HEREIN; NEITHER DOES IT CONVEY ANY LICENSE UNDER ITS PATENT RIGHTS, NOR THE RIGHTS OF OTHERS. THESE SPECIFICATIONS DO NOT EXPAND THE TERMS OF FAIRCHILD'S WORLDWIDE TERMS AND CONDITIONS, SPECIFICALLY THE WARRANTY THEREIN, WHICH COVERS THESE PRODUCTS.

LIFE SUPPORT POLICY

FAIRCHILD'S PRODUCTS ARE NOT AUTHORIZED FOR USE AS CRITICAL COMPONENTS IN LIFE SUPPORT DEVICES OR SYSTEMS WITHOUT THE EXPRESS WRITTEN APPROVAL OF FAIRCHILD SEMICONDUCTOR CORPORATION.

As used herein:

- Life support devices or systems are devices or systems which, (a) are intended for surgical implant into the body or (b) support or sustain life, and (c) whose failure to perform when properly used in accordance with instructions for use provided in the labeling, can be reasonably expected to result in a significant injury of the user.
- A critical component in any component of a life support, device, or system whose failure to perform can be reasonably expected to cause the failure of the life support device or system, or to affect its safety or effectiveness.

ANTI-COUNTERFEITING POLICY

Fairchild Semiconductor Corporation's Anti-Counterfeiting Policy. Fairchild's Anti-Counterfeiting Policy is also stated on our external website, www.fairchildsemi.com, under Sales Support.

Counterfeiting of semiconductor parts is a growing problem in the industry. All manufacturers of semiconductor products are experiencing counterfeiting of their parts. Customers who inadvertently purchase counterfeit parts experience many problems such as loss of brand reputation, substandard performance, failed applications, and increased cost of production and manufacturing delays. Fairchild is taking strong measures to protect ourselves and our customers from the proliferation of counterfeit parts. Fairchild strongly encourages customers to purchase Fairchild parts either directly from Fairchild or from Authorized Fairchild Distributors who are listed by country on our web page cited above. Products customers buy either from Fairchild directly or from Authorized Fairchild Distributors are genuine parts, have full traceability, meet Fairchild's quality standards for handling and storage and provide access to Fairchild's full range of up-to-date technical and product information. Fairchild and our Authorized Distributors will stand behind all warranties and will appropriately address any warranty issues that may arise. Fairchild will not provide any warranty coverage or other assistance for parts bought from Unauthorized Sources. Fairchild is committed to combat this global problem and encourage our customers to do their part in stopping this practice by buying direct or from authorized distributors.

PRODUCT STATUS DEFINITIONS

Definition of Terms

Datasheet Identification	Product Status	Definition
Advance Information	Formative / In Design	Datasheet contains the design specifications for product development. Specifications may change in any manner without notice.
Preliminary	First Production	Datasheet contains preliminary data; supplementary data will be published at a later date. Fairchild Semiconductor reserves the right to make changes at any time without notice to improve design.
No Identification Needed	Full Production	Datasheet contains final specifications. Fairchild Semiconductor reserves the right to make changes at any time without notice to improve the design.
Obsolete	Not In Production	Datasheet contains specifications on a product that is discontinued by Fairchild Semiconductor. The datasheet is for reference information only.

Rev. I43