

FEATURES

- InGaP HBT Technology
- High Efficiency: 37%
- Low Quiescent Current: 50 mA
- Low Leakage Current in Shutdown Mode: <1 μ A
- Optimized for a 50 Ω System
- Low Profile Miniature Surface Mount Package: 1.56mm Max
- CDMA 1XRTT Compliant
- CDMA 1xEV-DO Compliant

APPLICATIONS

- PCS CDMA Wireless Handsets
- Dual Band CDMA Wireless Handsets
- Tri Mode CDMA Handsets with GPS

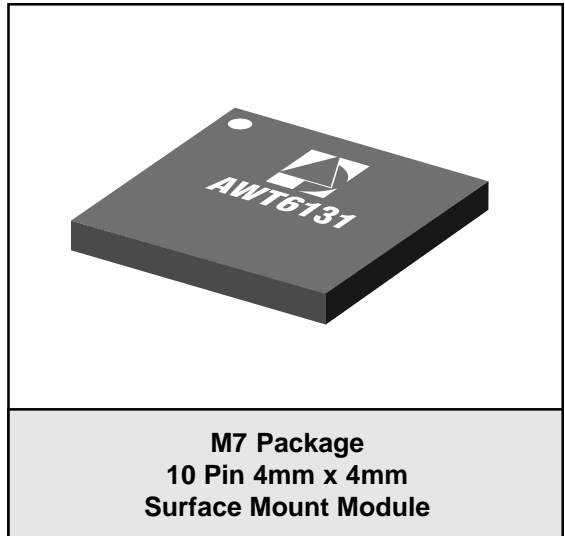

PRODUCT DESCRIPTION

The AWT6131 provides the additional output power margin RF designers need to overcome additional post-PA insertion loss in tri-mode handset designs supporting E911 (GPS enabled). The device is manufactured on an advanced InGaP HBT MMIC technology offering state-of-the-art reliability, temperature stability, and ruggedness. Selectable

bias modes that optimize efficiency for different output power levels, and a shutdown mode with low leakage current, increase handset talk and standby time. The self-contained 4mm x 4mm surface mount package incorporates matching networks optimized for output power, efficiency, and linearity in a 50 Ω system.

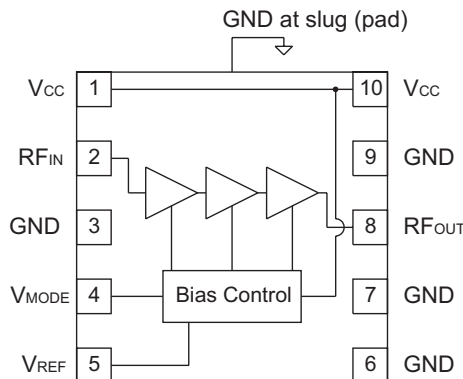

Figure 1: Block Diagram

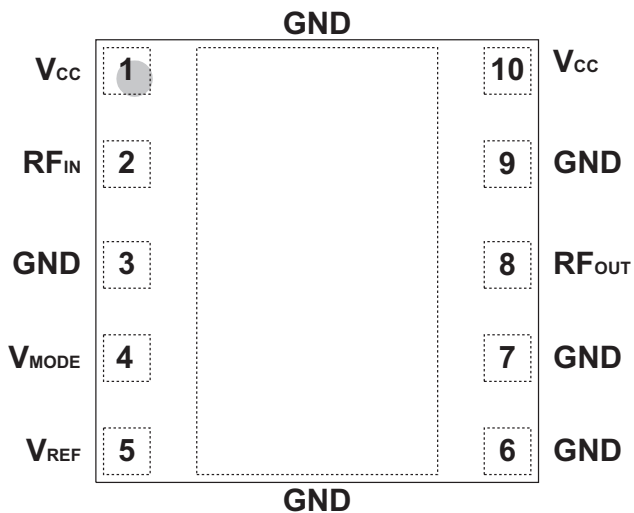

Figure 2: Pinout (X-ray Top View)

Table 1: Pin Description

PIN	NAME	DESCRIPTION
1	V_{CC}	Supply Voltage
2	RF_{IN}	RF Input
3	GND	Ground
4	V_{MODE}	Mode Control Voltage
5	V_{REF}	Reference Voltage
6	GND	Ground
7	GND	Ground
8	RF_{OUT}	RF Output
9	GND	Ground
10	V_{CC}	Supply Voltage

ELECTRICAL CHARACTERISTICS

Table 2: Absolute Minimum and Maximum Ratings

PARAMETER	MIN	MAX	UNIT
Supply Voltage (V_{CC})	0	+5	V
Mode Control Voltage (V_{MODE})	0	+3.5	V
Reference Voltage (V_{REF})	0	+3.5	V
RF Input Power (P_{IN})	-	+10	dBm
Storage Temperature (T_{STG})	-40	+150	°C

Stresses in excess of the absolute ratings may cause permanent damage. Functional operation is not implied under these conditions. Exposure to absolute ratings for extended periods of time may adversely affect reliability.

Table 3: Operating Ranges

PARAMETER	MIN	TYP	MAX	UNIT	COMMENTS
Operating Frequency (f)	1850	-	1910	MHz	
Supply Voltage (V_{CC})	+3.2	+3.5	+4.2	V	
Reference Voltage (V_{REF})	+2.8 0	+2.9 -	+3.1 +0.5	V	PA "on" PA "shut down"
Mode Control Voltage (V_{MODE})	+2.5 0	+2.9 -	+3.1 +0.5	V	Low Bias Mode High Bias Mode
RF Output Power (P_{OUT})	+29.0	-	-	dBm	
Case Temperature (T_C)	-30	-	+85	°C	

The device may be operated safely over these conditions; however, parametric performance is guaranteed only over the conditions defined in the electrical specifications.

Table 4: Electrical Specifications
(T_C = +25 °C, V_{CC} = +3.5 V, V_{REF} = +2.9 V, 50 Ω system)

PARAMETER	MIN	TYP	MAX	UNIT	COMMENTS
Gain	26 23.5	28 25	30 27.5	dB	P _{OUT} = +29 dBm, V _{MODE} = 0 V P _{OUT} = +16 dBm, V _{MODE} = +2.9 V
Adjacent Channel Power at ±1.25 kHz offset Primary Channel BW = 1.23 MHz Adjacent Channel BW = 30 kHz	- -	-48 -50	-46.5 -46.5	dB	P _{OUT} = +29 dBm, V _{MODE} = 0 V P _{OUT} = +16 dBm, V _{MODE} = +2.9 V
Adjacent Channel Power at ±2.25 MHz offset Primary Channel BW = 1.23 MHz Adjacent Channel BW = 30 kHz	- -	-61 -65	-57 -57	dB	P _{OUT} = +29 dBm, V _{MODE} = 0 V P _{OUT} = +16 dBm, V _{MODE} = +2.9 V
Power-Added Efficiency	35.5 6.5	37 7.5	- -	%	P _{OUT} = +29 dBm, V _{MODE} = 0 V P _{OUT} = +16 dBm, V _{MODE} = +2.9 V
Quiescent Current (I _{cq})	-	50	60	mA	V _{MODE} = +2.9 V
Reference Current	-	6.5	9	mA	through V _{REF} pin
Mode Control Current	-	0.3	0.5	mA	through V _{MODE} pin
Leakage Current	-	<1	5	μA	V _{CC} = +4.2 V, V _{REF} = 0 V V _{MODE} = 0 V
Noise in Receive Band	-	-135	-133	dBm/Hz	1930 MHz to 1990 MHz
Harmonics 2fo 3fo, 4fo	- -	-40 -55	-30 -30	dBc	
Input Impedance	-	-	2:1	VSWR	
Spurious Output Level (all spurious outputs)	-	-	-65	dBc	P _{OUT} ≤ +29 dBm In-band load VSWR < 8:1 Out-of-band load VSWR < 8:1 Applies over all voltage and temperature operating ranges
Load mismatch stress with no permanent degradation or failure	8:1	-	-	VSWR	V _{CC} = +5.0 V, P _{IN} = +5 dBm Applies over full operating temperature range

PERFORMANCE DATA

Figure 3: PAE vs. Frequency
P_{OUT} = +29 dBm, High Bias Mode
 (T_C = +25 °C, V_{CC} = +3.4 V, V_{REF} = +2.9 V, V_{MODE} = 0 V)

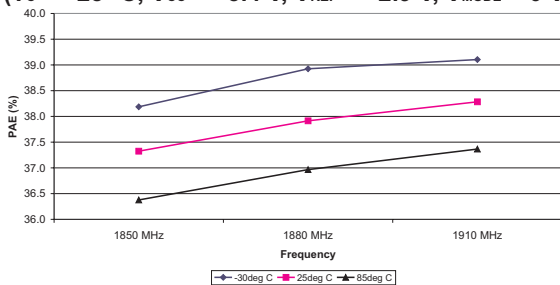

Figure 4: ACP1 vs. Frequency
P_{OUT} = +29 dBm, High Bias Mode
 (T_C = +25 °C, V_{CC} = +3.4 V, V_{REF} = +2.9 V, V_{MODE} = 0 V)

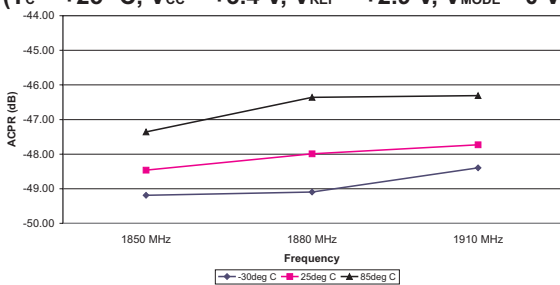

Figure 5: ACP2 vs. Frequency
P_{OUT} = +29 dBm, High Bias Mode
 (T_C = +25 °C, V_{CC} = +3.4 V, V_{REF} = +2.9 V, V_{MODE} = 0 V)

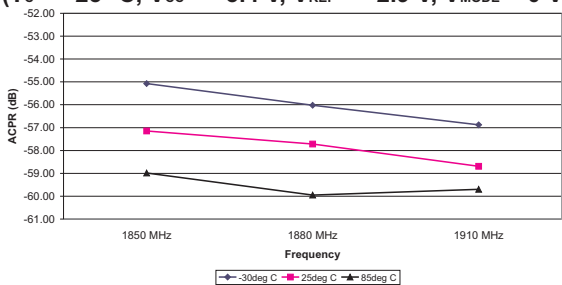

Figure 6: PAE vs. Frequency
P_{OUT} = +16 dBm, Low Bias Mode
 (T_C = +25 °C, V_{CC} = +3.4 V, V_{REF} = +2.9 V, V_{MODE} = +2.9 V)

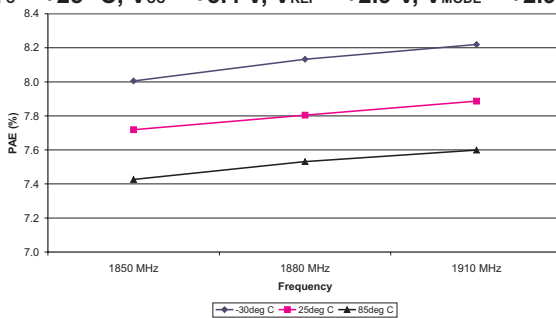

Figure 7: ACP1 vs. Frequency
P_{OUT} = +16 dBm, Low Bias Mode
 (T_C = +25 °C, V_{CC} = +3.4 V, V_{REF} = +2.9 V, V_{MODE} = +2.9 V)

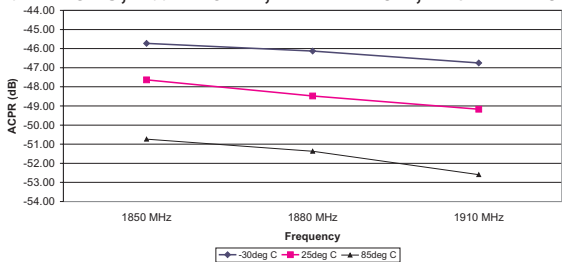
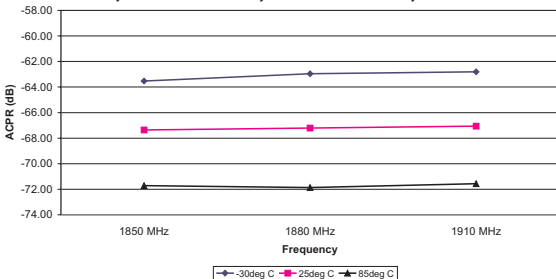

Figure 8: ACP2 vs. Frequency
P_{OUT} = +16 dBm, Low Bias Mode
 (T_C = +25 °C, V_{CC} = +3.4 V, V_{REF} = +2.9 V, V_{MODE} = +2.9 V)



PERFORMANCE DATA

Figure 9: Input Power vs. Output Power and Frequency
 (T_C = +25 °C, V_{CC} = +3.4 V, V_{REF} = +2.9 V)

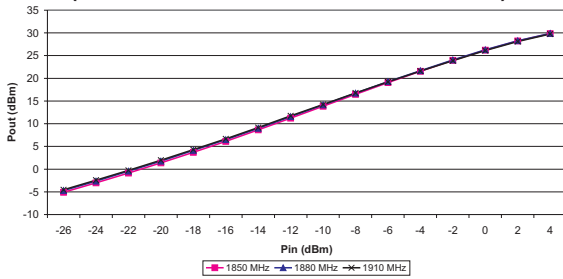

Figure 10: ACP1 & ACP2 vs. Output Power and Frequency
 (T_C = +25 °C, V_{CC} = +3.4 V, V_{REF} = +2.9 V)

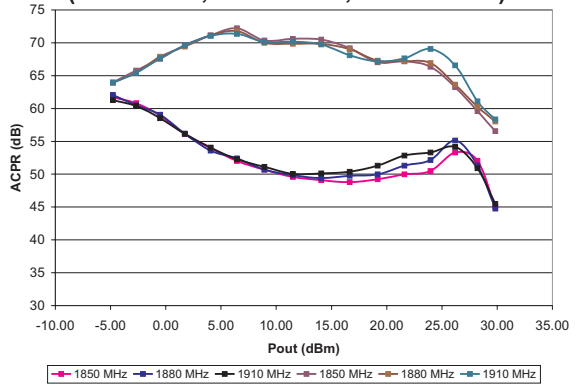
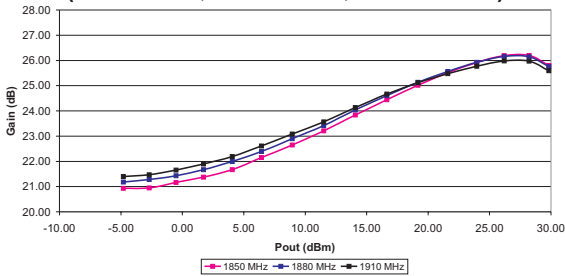

Figure 11: Large Signal Gain vs. Output Power and Frequency
 (T_C = +25 °C, V_{CC} = +3.4 V, V_{REF} = +2.9 V)



APPLICATION INFORMATION

To ensure proper performance, refer to all related Application Notes on the ANADIGICS web site: <http://www.anadigics.com>

Shutdown Mode

The power amplifier may be placed in a shutdown mode by applying logic low levels (see Operating Ranges table) to both the V_{REF} and V_{MODE} voltages.

Bias Modes

The power amplifier may be placed in either a Low Bias mode or a High Bias mode by applying the appropriate logic level (see Operating Ranges table) to the V_{MODE} voltage. The Bias Control table lists the recommended modes of operation for various applications.

Table 5: Bias Control

APPLICATION	P_{OUT} LEVELS	BIAS MODE	V_{REF}	V_{MODE}
CDMA - low power	$\leq +16\text{dBm}$	Low	+2.9 V	+2.9 V
CDMA - high power	$> +16\text{ dBm}$	High	+2.9 V	0 V
Shutdown	-	Shutdown	0 V	0 V

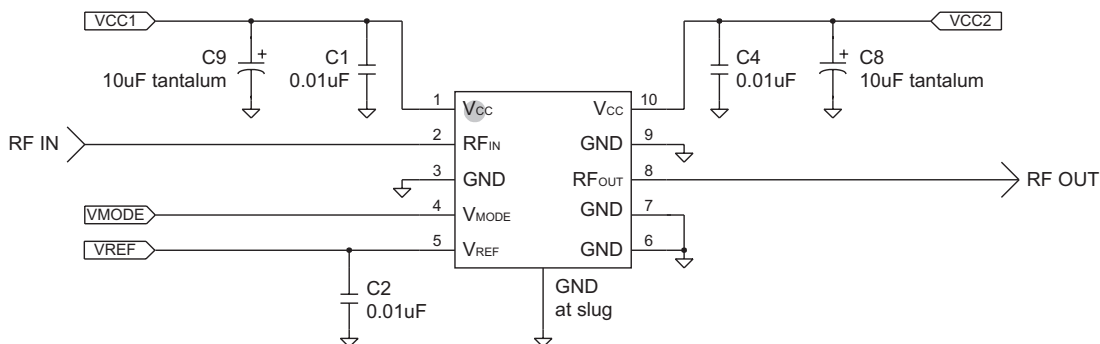
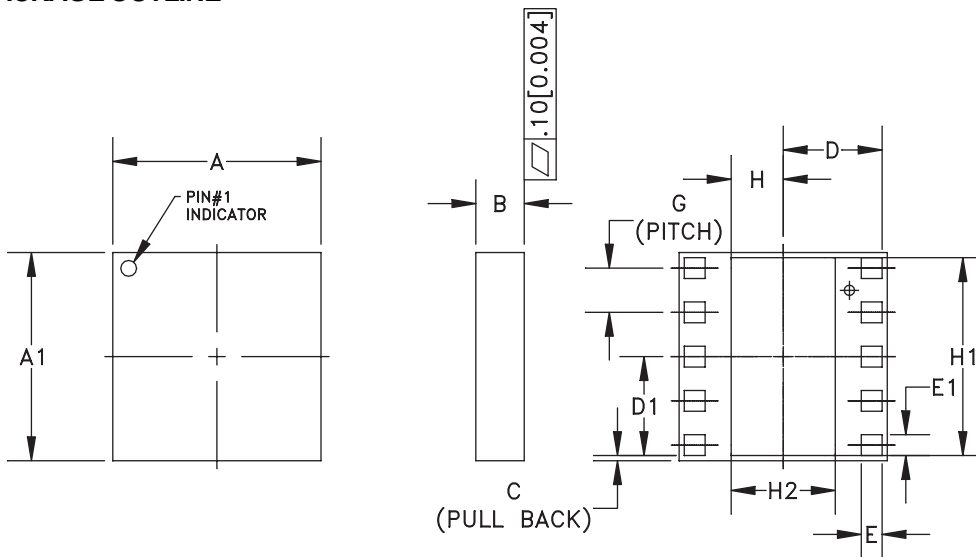

Figure 12: Application Circuit Schematic

PACKAGE OUTLINE



S _{MD}	MILLIMETERS			INCHES			NOTE
	MIN.	NOM.	MAX.	MIN.	NOM.	MAX.	
A	3.88	4.00	4.12	0.152	0.157	0.162	-
A1	3.88	4.00	4.12	0.152	0.157	0.162	-
B	1.26	1.41	1.56	0.049	0.055	0.061	-
C	-	0.10	-	-	0.004	-	-
D	-	1.90	-	-	0.075	-	-
D1	-	1.90	-	-	0.075	-	-
E	0.35	0.40	0.45	0.013	0.015	0.017	-
E1	0.35	0.40	0.45	0.013	0.015	0.017	-
G	0.85 BSC			0.033 BSC			-
H	-	1.00	-	-	0.039	-	-
H1	-	3.80	-	-	0.149	-	-
H2	-	2.00	-	-	0.078	-	-

NOTES:

1. CONTROLLING DIMENSIONS: MILLIMETERS
2. UNLESS SPECIFIED TOLERANCE=±0.076[0.003].

Figure 13: M7 Package Outline - 10 Pin 4mm x 4mm Surface Mount Module

TOP BRAND



NOTES:

1. ANADIGICS LOGO SIZE: X=0.040±0.010 Y=0.048±0.010
2. PART # AWT6131
3. YEAR AND WORK WEEK: YYWW: YY = YEAR, WW = WORK WEEK
4. LOT - WAFER I.D.: LLLLL - SS = WAFER/LOT I.D.
5. PIN 1 INDICATOR: MOLD NOTCH -or- INK DOT
6. BOM # & REV. BBB
7. COUNTRY CODE: CCCCC
8. TYPE : ELITE
SIZE : AS LARGE AS POSSIBLE
WHITE or SILVER

Figure 14: Branding Specification

COMPONENT PACKAGING

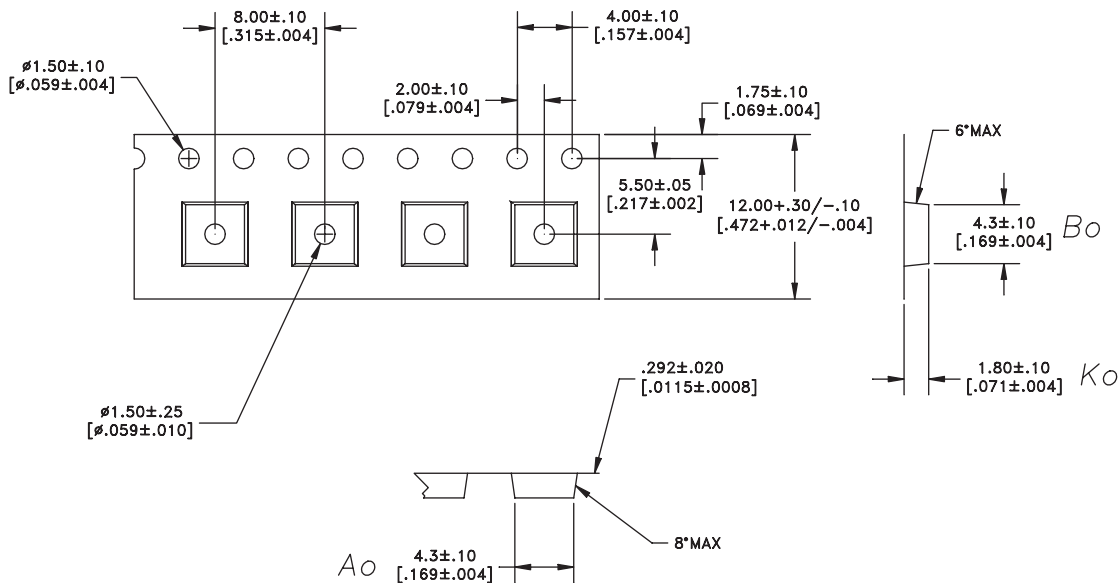

DIMENSIONS ARE IN MILLIMETERS [INCHES]
STANDARD TOLERANCES

Figure 15: Tape & Reel Packaging

Table 6: Tape & Reel Dimensions

PACKAGE TYPE	TAPE WIDTH	POCKET PITCH	REEL CAPACITY	MAX REEL DIA
4mm X 4mm	12mm	8mm	2500	13"

AWT6131

NOTES

NOTES

ORDERING INFORMATION

ORDER NUMBER	TEMPERATURE RANGE	PACKAGE DESCRIPTION	COMPONENT PACKAGING
AWT6131M7P8	-30 °C to +110 °C	10 Pin 4mm x 4mm Surface Mount Module	Tape and Reel, 2500 pieces per Reel



ANADIGICS, Inc.

141 Mount Bethel Road
Warren, New Jersey 07059, U.S.A.
Tel: +1 (908) 668-5000
Fax: +1 (908) 668-5132

URL: <http://www.anadigics.com>
E-mail: Mktg@anadigics.com

IMPORTANT NOTICE

ANADIGICS, Inc. reserves the right to make changes to its products or to discontinue any product at any time without notice. The product specifications contained in Advanced Product Information sheets and Preliminary Data Sheets are subject to change prior to a product's formal introduction. Information in Data Sheets have been carefully checked and are assumed to be reliable; however, ANADIGICS assumes no responsibilities for inaccuracies. ANADIGICS strongly urges customers to verify that the information they are using is current before placing orders.

WARNING

ANADIGICS products are not intended for use in life support appliances, devices or systems. Use of an ANADIGICS product in any such application without written consent is prohibited.