



64K x 8 Static RAM

Features

- High speed
— $t_{AA} = 15 \text{ ns}$
- CMOS for optimum speed/power
- Low active power
— 770 mW
- Low standby power
— 28 mW
- Automatic power-down when deselected
- TTL-compatible inputs and outputs
- Easy memory expansion with \overline{CE}_1 , CE_2 , and \overline{OE} options

Functional Description

The CY7C1512 is a high-performance CMOS static RAM organized as 65,536 words by 8 bits. Easy memory expansion is provided by an active LOW chip enable (\overline{CE}_1), an active HIGH chip enable (CE_2), an active LOW output enable (\overline{OE}),

and three-state drivers. This device has an automatic power-down feature that reduces power consumption by more than 75% when deselected.

Writing to the device is accomplished by taking chip enable one (\overline{CE}_1) and write enable (\overline{WE}) inputs LOW and chip enable two (CE_2) input HIGH. Data on the eight I/O pins (I/O₀ through I/O₇) is then written into the location specified on the address pins (A₀ through A₁₅).

Reading from the device is accomplished by taking chip enable one (\overline{CE}_1) and output enable (\overline{OE}) LOW while forcing write enable (\overline{WE}) and chip enable two (CE_2) HIGH. Under these conditions, the contents of the memory location specified by the address pins will appear on the I/O pins.

The eight input/output pins (I/O₀ through I/O₇) are placed in a high-impedance state when the device is deselected (\overline{CE}_1 HIGH or CE_2 LOW), the outputs are disabled (\overline{OE} HIGH), or during a write operation (\overline{CE}_1 LOW, CE_2 HIGH, and \overline{WE} LOW).

The CY7C1512 is available in standard 450-mil-wide plastic SOIC and 400-mil plastic SOJ packages.

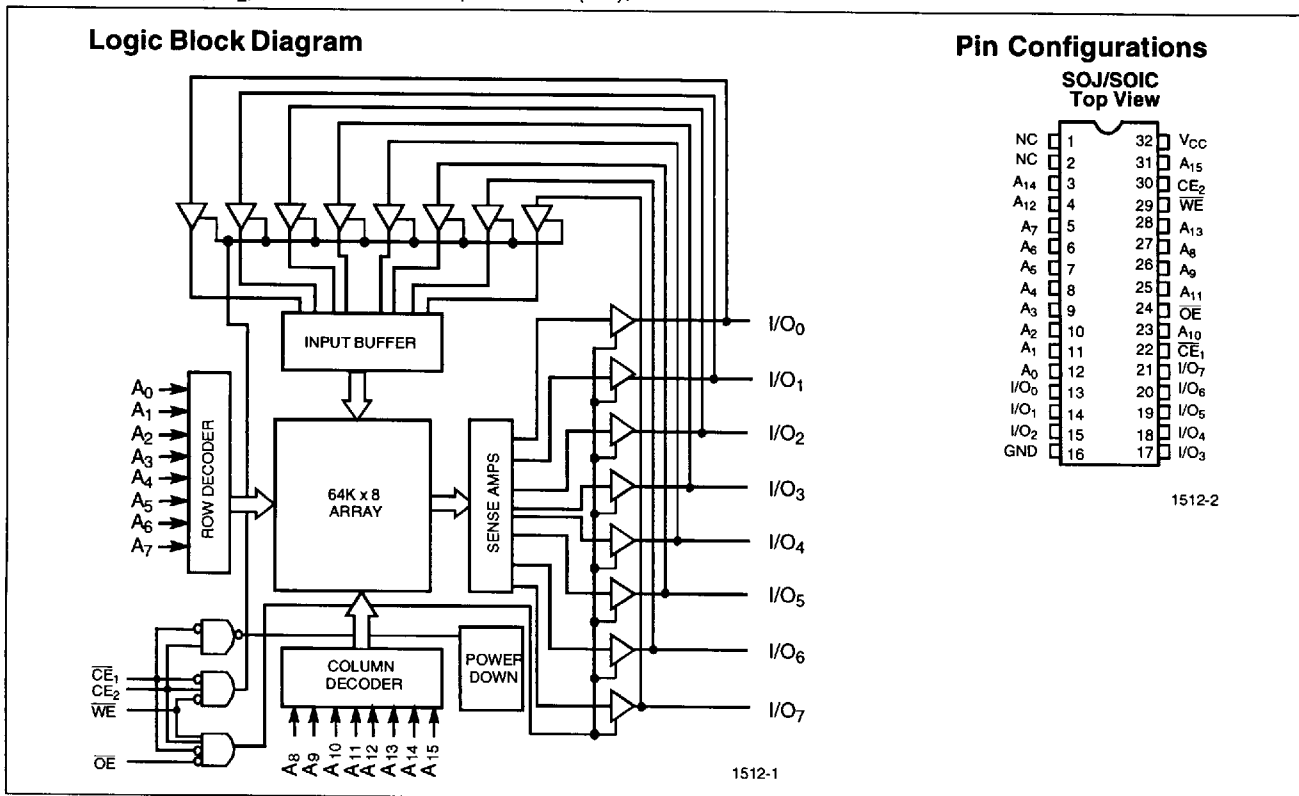

Selection Guide

		7C1512-15	7C1512-20	7C1512-25	7C1512-35	7C1512-70
Maximum Access Time (ns)		15	20	25	35	70
Maximum Operating Current (mA)	Commercial	140	130	120	110	110
Maximum CMOS Standby Current (mA)	Commercial	5	5	5	5	5



Maximum Ratings

(Above which the useful life may be impaired. For user guidelines, not tested.)

Storage Temperature -65°C to +150°C
 Ambient Temperature with Power Applied..... -55°C to +125°C
 Supply Voltage on V_{CC} to Relative GND^[1] -0.5V to +7.0V
 DC Voltage Applied to Outputs in High Z State^[1] -0.5V to V_{CC} +0.5V

DC Input Voltage^[1] -0.5V to V_{CC} +0.5V
 Current into Outputs (LOW) 20 mA
 Static Discharge Voltage >2001V (per MIL-STD-883, Method 3015)
 Latch-Up Current >200 mA

Operating Range

Range	Ambient Temperature ^[2]	V _{CC}
Commercial	0°C to +70°C	5V ± 10%

Electrical Characteristics Over the Operating Range^[3]

Parameter	Description	Test Conditions	7C1512-15		7C1512-20		7C1512-25		Unit
			Min.	Max.	Min.	Max.	Min.	Max.	
V _{OH}	Output HIGH Voltage	V _{CC} = Min., I _{OH} = -4.0 mA	2.4		2.4		2.4		V
V _{OL}	Output LOW Voltage	V _{CC} = Min., I _{OL} = 8.0 mA		0.4		0.4		0.4	V
V _{IH}	Input HIGH Voltage		2.2	V _{CC} +0.3	2.2	V _{CC} +0.3	2.2	V _{CC} +0.3	V
V _{IL}	Input LOW Voltage ^[1]		-0.3	0.8	-0.3	0.8	-0.3	0.8	V
I _{Ix}	Input Load Current	GND ≤ V _I ≤ V _{CC}	-1	+1	-1	+1	-1	+1	μA
I _{OZ}	Output Leakage Current	GND ≤ V _I ≤ V _{CC} , Output Disabled	-5	+5	-5	+5	-5	+5	μA
I _{OS}	Output Short Circuit Current ^[4]	V _{CC} = Max., V _{OUT} = GND		-300		-300		-300	mA
I _{CC}	V _{CC} Operating Supply Current	V _{CC} = Max., I _{OUT} = 0 mA, f = f _{MAX} = 1/f _{RC}		140		130		120	mA
I _{SB1}	Automatic CE Power-Down Current —TTL Inputs	Max. V _{CC} , CE ₁ ≥ V _{IH} or CE ₂ ≤ V _{IL} , V _{IN} ≥ V _{IH} or V _{IN} ≤ V _{IL} , f = f _{MAX}		40		30		30	mA
I _{SB2}	Automatic CE Power-Down Current —CMOS Inputs	Max. V _{CC} , CE ₁ ≥ V _{CC} - 0.3V, or CE ₂ ≤ 0.3V, V _{IN} ≥ V _{CC} - 0.3V, or V _{IN} ≤ 0.3V, f=0		5		5		5	mA

Parameter	Description	Test Conditions	7C1512-35		7C1512-70		Unit
			Min.	Max.	Min.	Max.	
V _{OH}	Output HIGH Voltage	V _{CC} = Min., I _{OH} = -4.0 mA	2.4		2.4		V
V _{OL}	Output LOW Voltage	V _{CC} = Min., I _{OL} = 8.0 mA		0.4		0.4	V
V _{IH}	Input HIGH Voltage		2.2	V _{CC} +0.3	2.2	V _{CC} +0.3	V
V _{IL}	Input LOW Voltage ^[1]		-0.3	0.8	-0.3	0.8	V
I _{Ix}	Input Load Current	GND ≤ V _I ≤ V _{CC}	-1	+1	-1	+1	μA
I _{OZ}	Output Leakage Current	GND ≤ V _I ≤ V _{CC} , Output Disabled	-5	+5	-5	+5	μA
I _{OS}	Output Short Circuit Current ^[4]	V _{CC} = Max., V _{OUT} = GND		-300		-300	mA
I _{CC}	V _{CC} Operating Supply Current	V _{CC} = Max., I _{OUT} = 0 mA, f = f _{MAX} = 1/f _{RC}		110		110	mA
I _{SB1}	Automatic CE Power-Down Current —TTL Inputs	Max. V _{CC} , CE ₁ ≥ V _{IH} or CE ₂ ≤ V _{IL} , V _{IN} ≥ V _{IH} or V _{IN} ≤ V _{IL} , f = f _{MAX}		25		25	mA
I _{SB2}	Automatic CE Power-Down Current —CMOS Inputs	Max. V _{CC} , CE ₁ ≥ V _{CC} - 0.3V, or CE ₂ ≤ 0.3V, V _{IN} ≥ V _{CC} - 0.3V, or V _{IN} ≤ 0.3V, f=0		5		5	mA

Notes:

- V_{IL} (min.) = -2.0V for pulse durations of less than 20 ns.
- T_A is the "instant on" case temperature.
- See the last page of this specification for Group A subgroup testing information.
- Not more than one output should be shorted at one time. Duration of the short circuit should not exceed 30 seconds.

Capacitance^[5]

Parameter	Description	Test Conditions	Max.	Unit
C _{IN}	Input Capacitance	T _A = 25°C, f = 1 MHz, V _{CC} = 5.0V	9	pF
C _{OUT}	Output Capacitance		9	pF

AC Test Loads and Waveforms

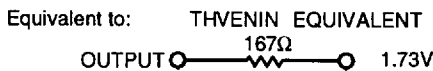
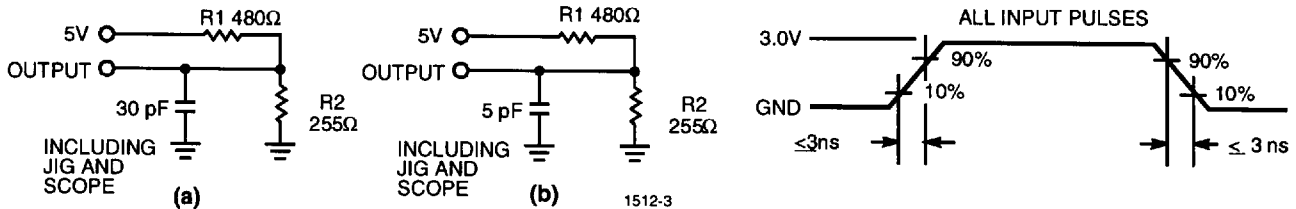

Switching Characteristics^[3, 6] Over the Operating Range

Parameter	Description	7C1512-15		7C1512-20		7C1512-25		Unit
		Min.	Max.	Min.	Max.	Min.	Max.	
READ CYCLE								
t _{RC}	Read Cycle Time	15		20		25		ns
t _{AA}	Address to Data Valid		15		20		25	ns
t _{OHA}	Data Hold from Address Change	3		3		5		ns
t _{ACE}	\overline{CE}_1 LOW to Data Valid, CE ₂ HIGH to Data Valid		15		20		25	ns
t _{DOE}	\overline{OE} LOW to Data Valid		7		8		10	ns
t _{LZOE}	\overline{OE} LOW to Low Z	0		0		0		ns
t _{HZOE}	\overline{OE} HIGH to High Z ^[7, 8]		7		8		10	ns
t _{LZCE}	\overline{CE}_1 LOW to Low Z, CE ₂ HIGH to Low Z ^[8]	3		3		5		ns
t _{HZCE}	\overline{CE}_1 HIGH to High Z, CE ₂ LOW to High Z ^[7, 8]		7		8		10	ns
t _{PU}	\overline{CE}_1 LOW to Power-Up, CE ₂ HIGH to Power-Up	0		0		0		ns
t _{PD}	\overline{CE}_1 HIGH to Power-Down, CE ₂ LOW to Power-Down		15		20		25	ns
WRITE CYCLE^[9]								
t _{WC}	Write Cycle Time	15		20		25		ns
t _{SCE}	\overline{CE}_1 LOW to Write End, CE ₂ HIGH to Write End	12		15		20		ns
t _{AW}	Address Set-Up to Write End	12		15		20		ns
t _{HA}	Address Hold from Write End	0		0		0		ns
t _{SA}	Address Set-Up to Write Start	0		0		0		ns
t _{PWE}	\overline{WE} Pulse Width	12		15		20		ns
t _{SD}	Data Set-Up to Write End	8		10		15		ns
t _{HD}	Data Hold from Write End	0		0		0		ns
t _{LZWE}	\overline{WE} HIGH to Low Z ^[8]	3		3		5		ns
t _{HZWE}	\overline{WE} LOW to High Z ^[7, 8]		7		8		10	ns

5. Tested initially and after any design or process changes that may affect these parameters.
 6. Test conditions assume signal transition time of 3 ns or less, timing reference levels of 1.5V, input pulse levels of 0 to 3.0V, and output loading of the specified t_{OL}/t_{OH} and 30-pF load capacitance.
 7. t_{HZOE}, t_{HZCE}, and t_{HZWE} are specified with a load capacitance of 5 pF as in part (b) of AC Test Loads. Transition is measured ±500 mV from steady-state voltage.
 8. At any given temperature and voltage condition, t_{HZCE} is less than t_{LZCE}; t_{LZOE} is less than t_{LZCE}; and t_{LZWE} is less than t_{LZCE} for any given device.
 9. The internal write time of the memory is defined by the overlap of \overline{CE}_1 LOW, CE₂ HIGH, and \overline{WE} LOW. \overline{CE}_1 and \overline{WE} must be LOW and CE₂ HIGH to initiate a write, and the transition of any of these signals can terminate the write. The input data set-up and hold timing should be referenced to the leading edge of the signal that terminates the write.



Switching Characteristics^[3, 6] Over the Operating Range (continued)

Parameter	Description	7C1512-35		7C1512-70		Unit
		Min.	Min.	Min.	Min.	
READ CYCLE						
t_{RC}	Read Cycle Time	35		70		ns
t_{AA}	Address to Data Valid		35		70	ns
t_{OHA}	Data Hold from Address Change	5		5		ns
t_{ACE}	\overline{CE}_1 LOW to Data Valid, CE_2 HIGH to Data Valid		35		70	ns
t_{DOE}	\overline{OE} LOW to Data Valid		15		15	ns
t_{LZOE}	\overline{OE} LOW to Low Z	0		0		ns
t_{HZOE}	\overline{OE} HIGH to High Z ^[7, 8]		15		15	ns
t_{LZCE}	\overline{CE}_1 LOW to Low Z, CE_2 HIGH to Low Z ^[8]	5		5		ns
t_{HZCE}	\overline{CE}_1 HIGH to High Z, CE_2 LOW to High Z ^[7, 8]		15		15	ns
t_{PU}	\overline{CE}_1 LOW to Power-Up, CE_2 HIGH to Power-Up	0		0		ns
t_{PD}	\overline{CE}_1 HIGH to Power-Down, CE_2 LOW to Power-Down		35		70	ns
WRITE CYCLE^[9]						
t_{WC}	Write Cycle Time	35		70		ns
t_{SCE}	\overline{CE}_1 LOW to Write End, CE_2 HIGH to Write End	25		60		ns
t_{AW}	Address Set-Up to Write End	25		60		ns
t_{HA}	Address Hold from Write End	0		0		ns
t_{SA}	Address Set-Up to Write Start	0		0		ns
t_{PWE}	\overline{WE} Pulse Width	25		60		ns
t_{SD}	Data Set-Up to Write End	20		55		ns
t_{HD}	Data Hold from Write End	0		0		ns
t_{LZWE}	\overline{WE} HIGH to Low Z ^[8]	5		5		ns
t_{HZWE}	\overline{WE} LOW to High Z ^[7, 8]		15		15	ns

Switching Waveforms

Read Cycle No. 1^[10, 11]

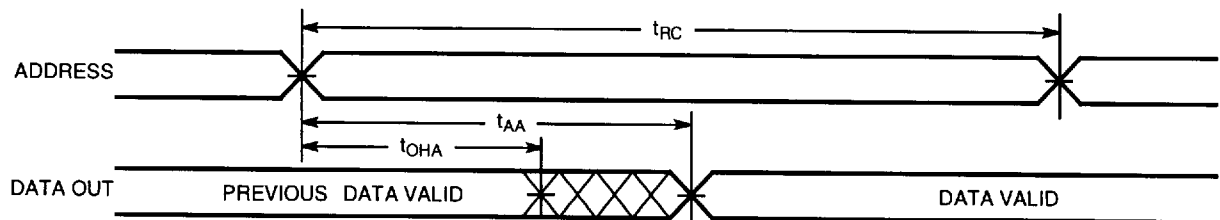

1512-5

Notes:

- 10. Device is continuously selected. \overline{OE} , $\overline{CE}_1 = V_{IL}$, $CE_2 = V_{IH}$.
- 11. \overline{WE} is HIGH for read cycle.

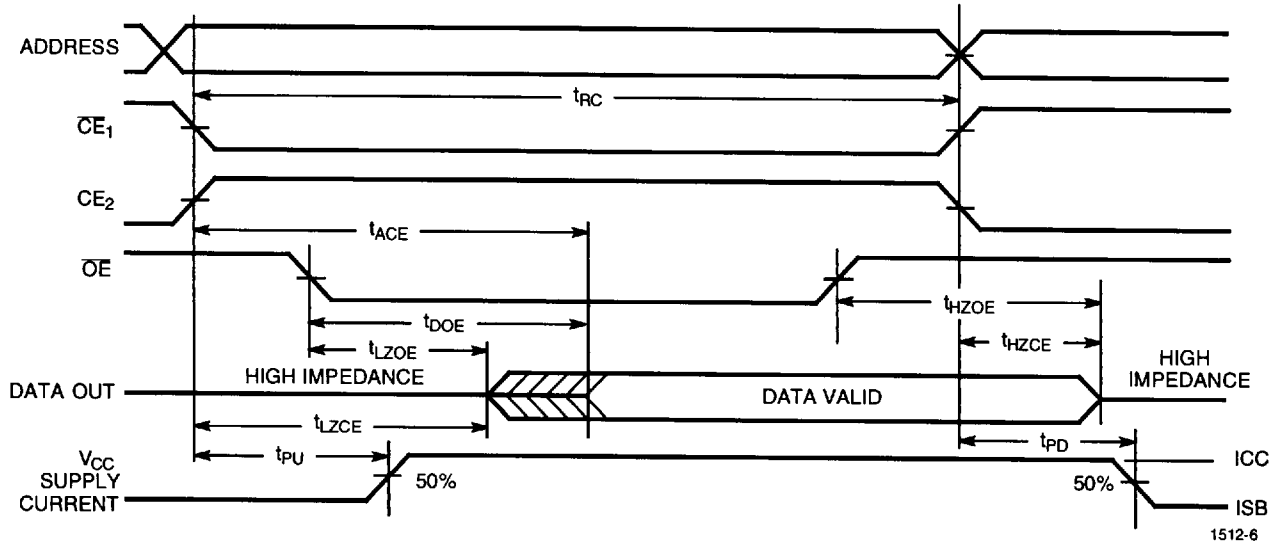
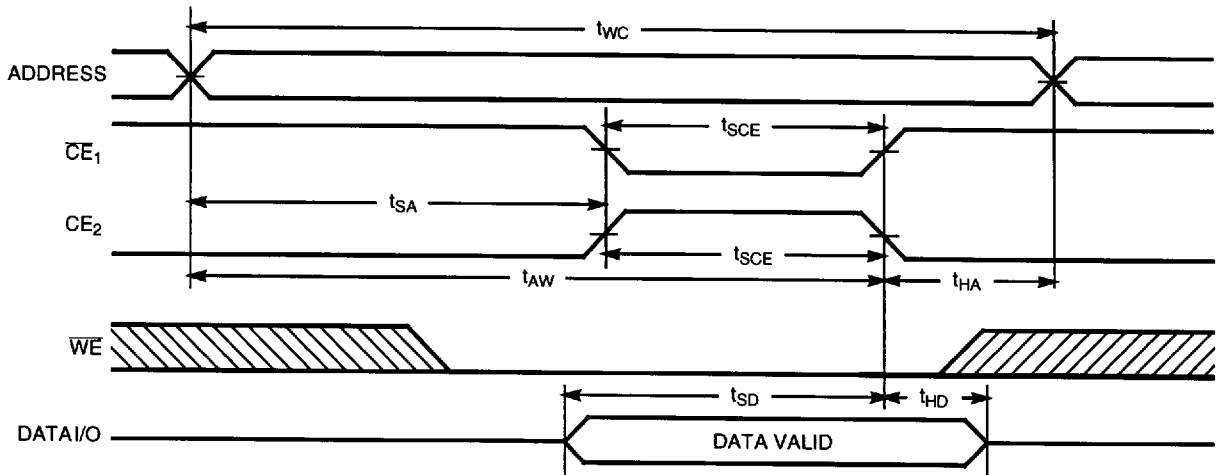
Switching Waveforms (continued)
Read Cycle No. 2 (\overline{OE} Controlled) [11, 12]

Write Cycle No. 1 (\overline{CE}_1 or \overline{CE}_2 Controlled) [13, 14]

Notes:

12. Address valid prior to or coincident with \overline{CE}_1 transition LOW and \overline{CE}_2 transition HIGH.
13. Data I/O is high impedance if $\overline{OE} = V_{IH}$.
14. If \overline{CE}_1 goes HIGH or \overline{CE}_2 goes LOW simultaneously with \overline{WE} going HIGH, the output remains in a high-impedance state.

1512-7

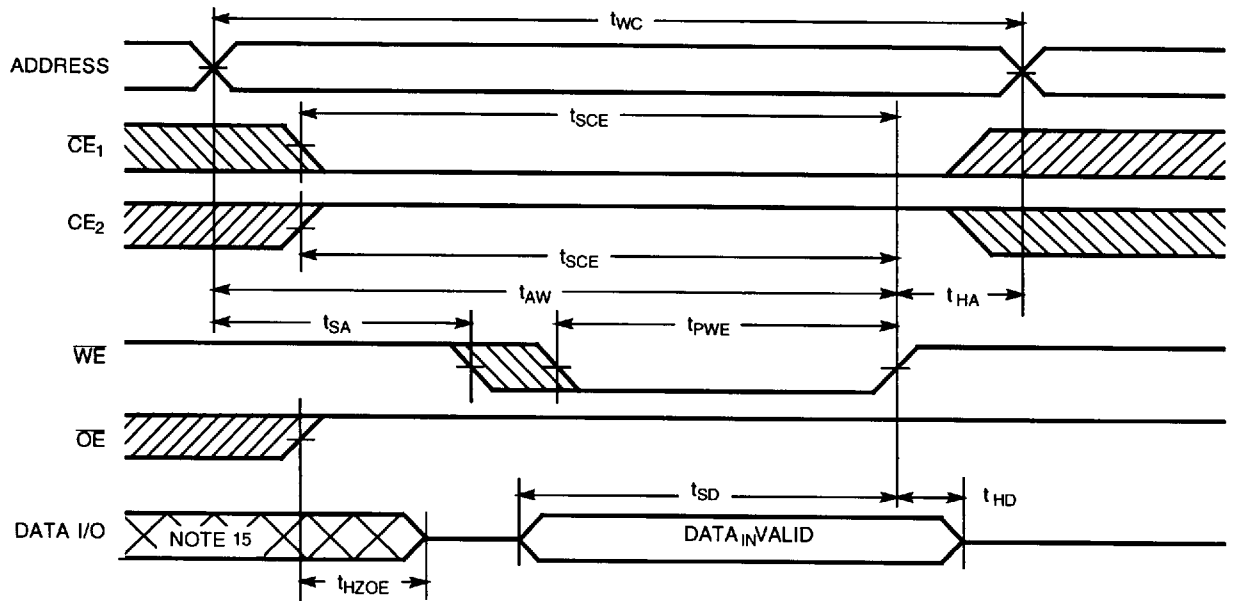
Switching Waveforms (continued)

Read Cycle No. 2 (\overline{WE} Controlled, \overline{OE} HIGH During Write)^[13, 14]



1512-8

Write Cycle No. 3 (\overline{WE} Controlled, \overline{OE} LOW)^[14]

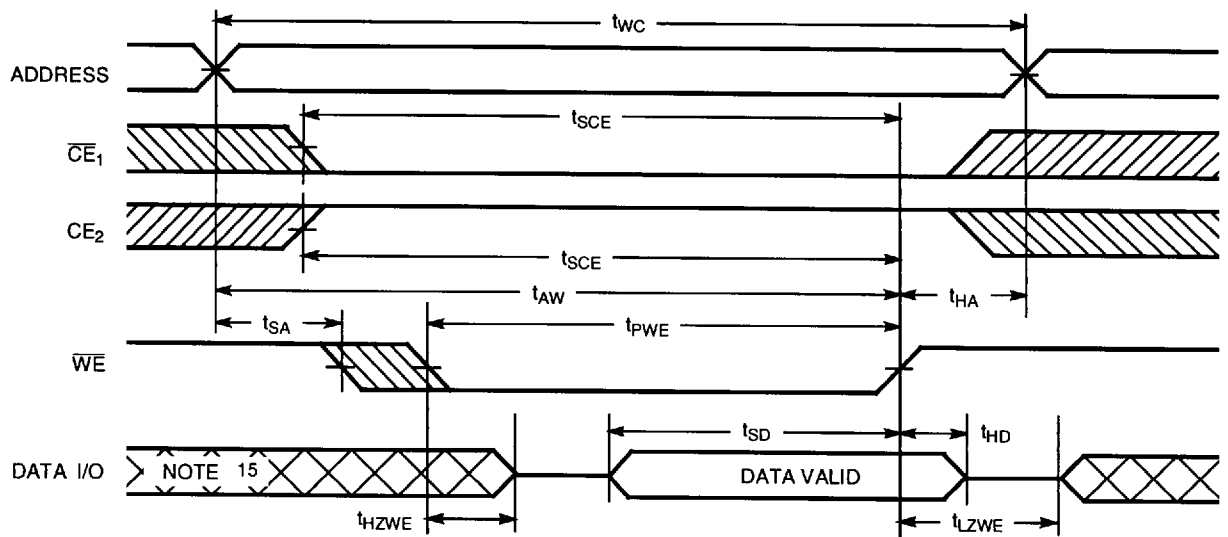

1512-9

Note:

15. During this period the I/Os are in the output state and input signals should not be applied.



Truth Table

CE ₁	CE ₂	OE	WE	I/O ₀ - I/O ₇	Mode	Power
H	X	X	X	High Z	Power-Down	Standby (I _{SB})
X	L	X	X	High Z	Power-Down	Standby (I _{SB})
L	H	L	H	Data Out	Read	Active (I _{CC})
L	H	X	L	Data In	Write	Active (I _{CC})
L	H	H	H	High Z	Selected, Outputs Disabled	Active (I _{CC})

Ordering Information

Speed (ns)	Ordering Code	Package Name	Package Type	Operating Range
15	CY7C1512-15SC	S34	32-Lead (450-Mil) Molded SOIC	Commercial
	CY7C1512-15VC	V33	32-Lead (400-Mil) Molded SOJ	
20	CY7C1512-20SC	S34	32-Lead (450-Mil) Molded SOIC	Commercial
	CY7C1512-20VC	V33	32-Lead (400-Mil) Molded SOJ	
25	CY7C1512-25SC	S34	32-Lead (450-Mil) Molded SOIC	Commercial
	CY7C1512-25VC	V33	32-Lead (400-Mil) Molded SOJ	
35	CY7C1512-35SC	S34	32-Lead (450-Mil) Molded SOIC	Commercial
	CY7C1512-35VC	V33	32-Lead (400-Mil) Molded SOJ	
70	CY7C1512-70SC	S34	32-Lead (450-Mil) Molded SOIC	Commercial
	CY7C1512-70VC	V33	32-Lead (400-Mil) Molded SOJ	

Shaded areas contain advanced information.

Document #: 38-00522

Package Diagrams

32-Lead (450-Mil) Molded SOIC S34

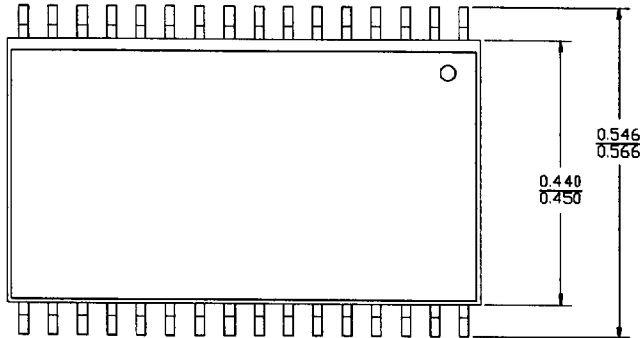

DIMENSIONS IN INCHES MIN. MAX.

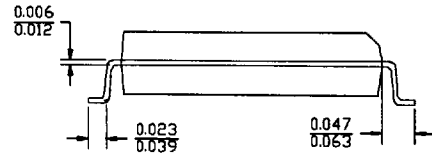
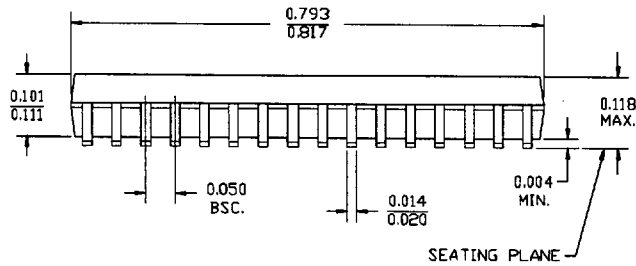

32-Lead (400-Mil) Molded SOJ V33

DIMENSIONS IN INCHES MIN. MAX.

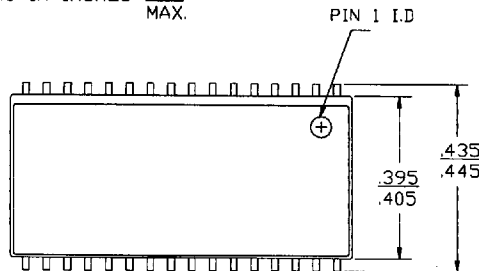

DETAIL A
EXTERNAL LEAD DESIGN

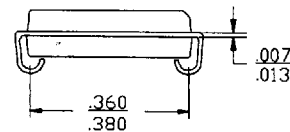
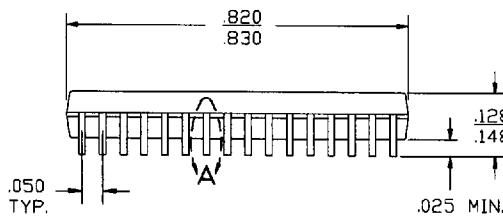
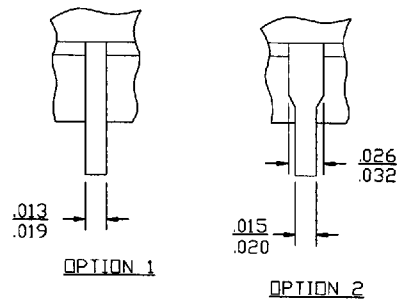

© Cypress Semiconductor Corporation, 1996. The information contained herein is subject to change without notice. Cypress Semiconductor Corporation assumes no responsibility for the use of any circuitry other than circuitry embodied in a Cypress Semiconductor product. Nor does it convey or imply any license under patent or other rights. Cypress Semiconductor does not authorize its products for use as critical components in life-support systems where a malfunction or failure may reasonably be expected to result in significant injury to the user. The inclusion of Cypress Semiconductor products in life-support systems application implies that the manufacturer assumes all risk of such use and in doing so indemnifies Cypress Semiconductor against all charges.