

## LM311

### *Single Comparator*

The LM311 series is a monolithic, low input current voltage comparator. The device is also designed to operate from dual or single supply voltage.

---

#### **Rochester Electronics Manufactured Components**

Rochester branded components are manufactured using either die/wafers purchased from the original suppliers or Rochester wafers recreated from the original IP. All re-creations are done with the approval of the Original Component Manufacturer (OCM).

Parts are tested using original factory test programs or Rochester developed test solutions to guarantee product meets or exceeds the OCM data sheet.

#### **Quality Overview**

- ISO-9001
- AS9120 certification
- Qualified Manufacturers List (QML) MIL-PRF-35835
  - Class Q Military
  - Class V Space Level
- Qualified Suppliers List of Distributors (QSLD)
  - Rochester is a critical supplier to DLA and meets all industry and DLA standards.

Rochester Electronics, LLC is committed to supplying products that satisfy customer expectations for quality and are equal to those originally supplied by industry manufacturers.

---

*The original manufacturer's datasheet accompanying this document reflects the performance and specifications of the Rochester manufactured version of this device. Rochester Electronics guarantees the performance of its semiconductor products to the original OCM specifications. 'Typical' values are for reference purposes only. Certain minimum or maximum ratings may be based on product characterization, design, simulation, or sample testing.*

**FOR REFERENCE ONLY**

# LM311

## Single Comparator

### Features

- Low input bias current : 250nA (Max)
- Low input offset current : 50nA (Max)
- Differential Input Voltage :  $\pm 30V$
- Power supply voltage : single 5.0V supply to  $\pm 15V$ .
- Offset voltage null capability.
- Strobe capability.

### Description

The LM311 series is a monolithic, low input current voltage comparator. The device is also designed to operate from dual or single supply voltage.

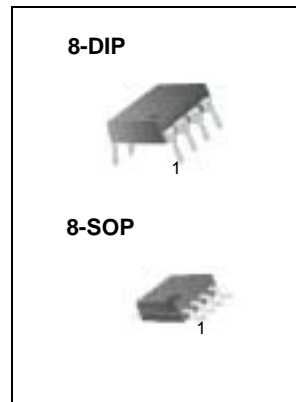

### Internal Block Diagram

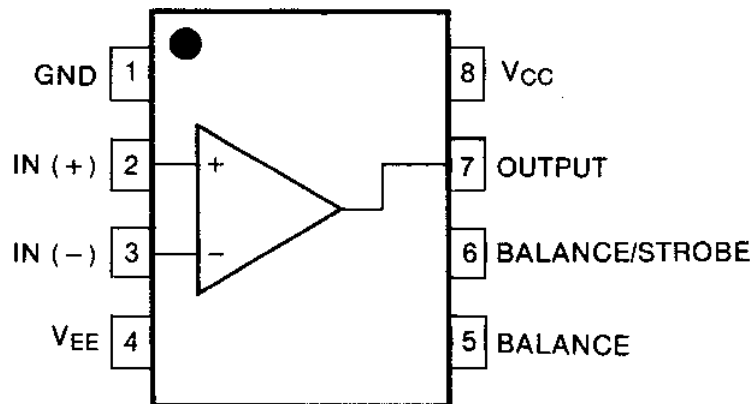

## Schematic Diagram

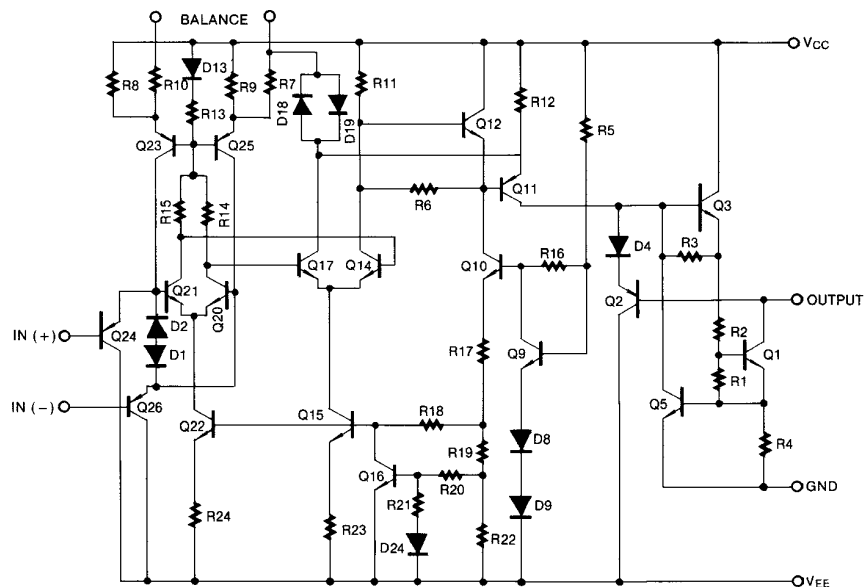

## Absolute Maximum Ratings

Parameter	Symbol	Value	Unit
Total Supply Voltage	VCC	36	V
Output to Negative Supply Voltage LM311	VO - VEE	40	V
Ground to Negative voltage	VEE	-30	V
Differential Input Voltage	VI(DIFF)	30	V
Input Voltage	VI	±15	V
Output Short Circuit Duration	-	10	sec
Power Dissipation	PD	500	mW
Operating Temperature Range	TOPR	0 ~ +70	°C
Storage Temperature Range	TSTG	- 65 ~ +150	°C

## Electrical Characteristics

(VCC = 15V, TA = 25°C, unless otherwise specified)

Parameter	Symbol	Conditions	Min.	Typ.	Max.	Unit	
Input Offset Voltage	V <sub>IO</sub>	R <sub>S</sub> ≤ 50KΩ	-	1.0	7.5	mV	
			Note 1	-	-		10
Input Offset Current	I <sub>IO</sub>		-	6	50	nA	
			Note 1	-	-		70
Input Bias Current	I <sub>BIAS</sub>		-	100	250	nA	
			Note 1	-	-		300
Voltage Gain	G <sub>V</sub>	-	40	200	-	V/mV	
Response Time	T <sub>RES</sub>		Note 2	-	200	-	ns
Saturation Voltage	V <sub>SAT</sub>	I <sub>O</sub> = 50mA, V <sub>I</sub> ≤ -10mV	-	0.75	1.5	V	
		V <sub>CC</sub> ≥ 4.5V, V <sub>EE</sub> = 0V I <sub>O</sub> = 8mA, V <sub>I</sub> ≤ -10mV, Note 1	-	0.23	0.4		
Strobe "ON" Current	I <sub>STR(ON)</sub>	-	-	3	-	mA	
Output Leakage Current	I <sub>SINK</sub>	I <sub>STR</sub> = 3mA, V <sub>I</sub> ≥ 10mV V <sub>O</sub> = 15V, V <sub>CC</sub> = ±15V	-	0.2	50	nA	
Input Voltage Range	V <sub>I(R)</sub>	Note 1	-14.5 to 13.0	-14.7 to 13.8	-	V	
Positive Supply Current	I <sub>CC</sub>	-	-	3.0	7.5	mA	
Negative Supply Current	I <sub>EE</sub>	-	-	-2.2	-5.0	mA	
Strobe Current	I <sub>STR</sub>	-	-	3	-	mA	

### Notes :

- 0 ≤ TA ≤ +70°C
- The response time specified is for a 100mV input step with 5mV over drive.

# Typical Performance Characteristics

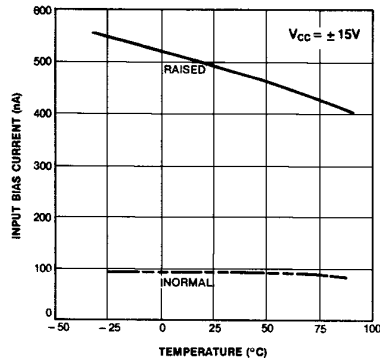

Figure 1. Input Bias Current vs Temperature

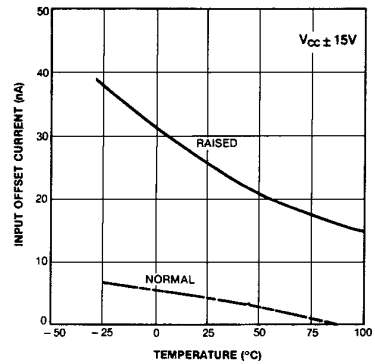

Figure 2. Input Offset Current vs Temperature

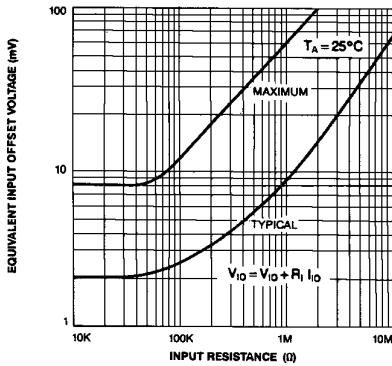

Figure 3. Offset Voltage vs Input Resistance

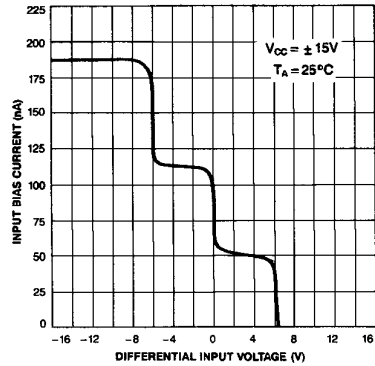

Figure 4. Input Bias Current vs Differential input voltage

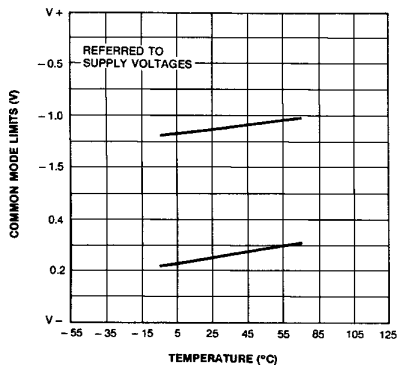

Figure 5. Common Mode Limits vs Temperature

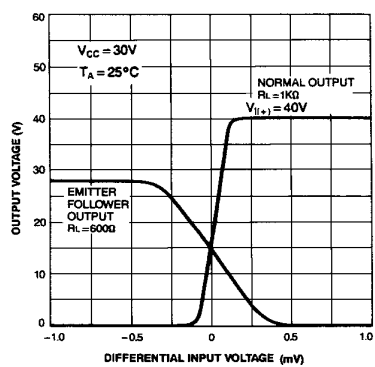

Figure 6. Output Voltage vs Differential input voltage

## Typical Performance Characteristics (continued)

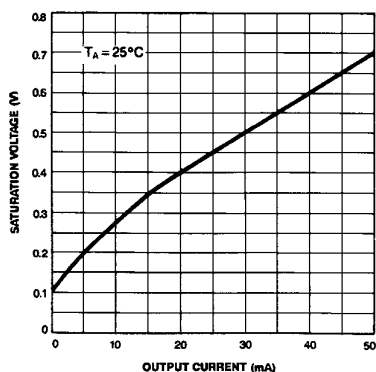

Figure 7. Saturation voltage vs Current

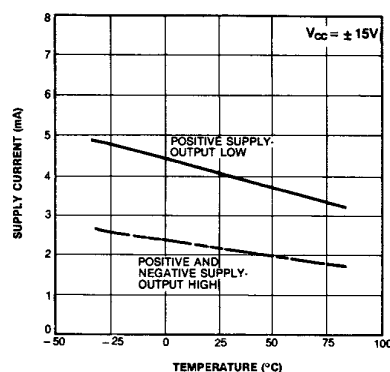

Figure 8. Supply Current vs Temperature

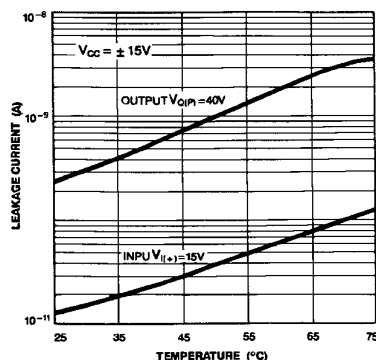

Figure 9. Leakage Current vs Temperature

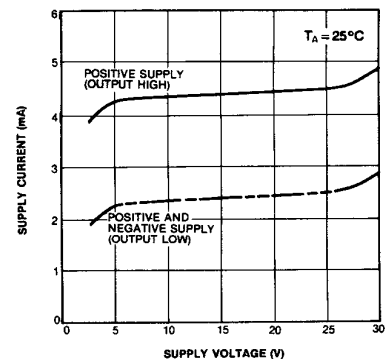

Figure 10. Supply Current vs Supply Voltage

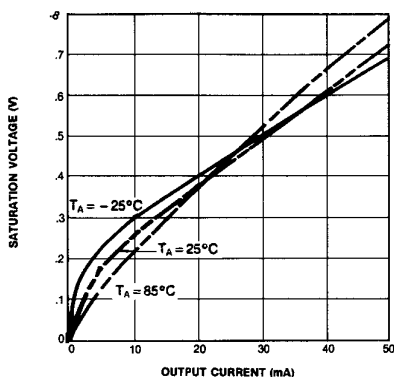

Figure 11. Current Saturation Voltage

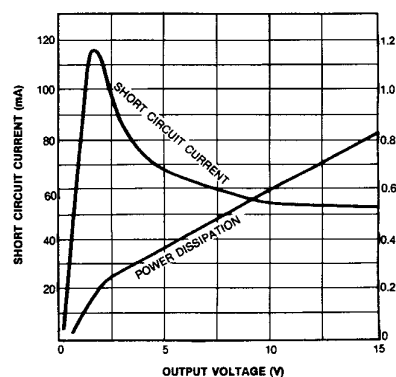
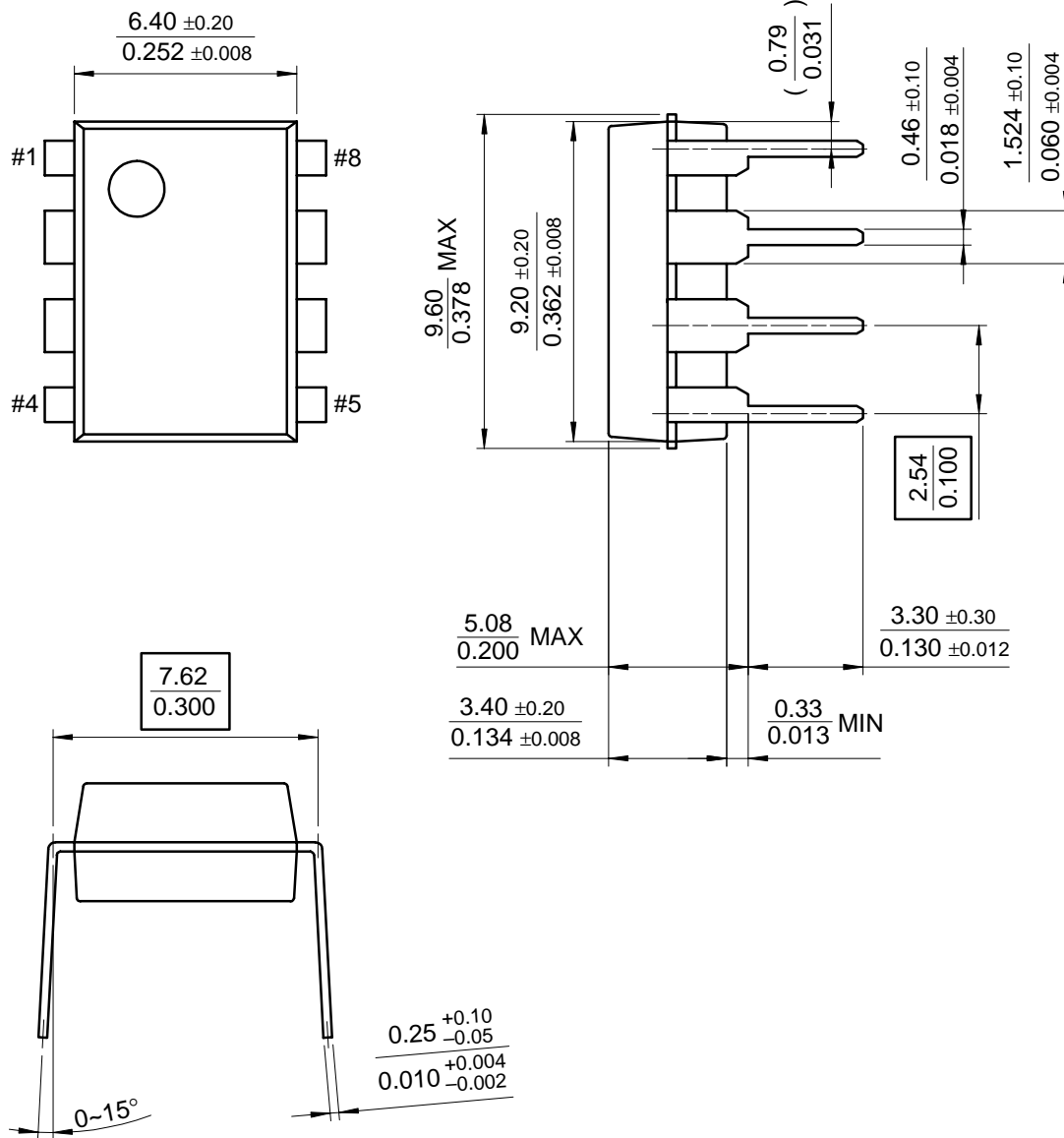

Figure 12. Output Limiting Characteristics

# Mechanical Dimensions

## Package

### 8-DIP







**Ordering Information**

<b>Product Number</b>	<b>Package</b>	<b>Operating Temperature</b>
LM311N	8-DIP	0 ~ +70°C
LM311M	8-SOP	



**DISCLAIMER**

FAIRCHILD SEMICONDUCTOR RESERVES THE RIGHT TO MAKE CHANGES WITHOUT FURTHER NOTICE TO ANY PRODUCTS HEREIN TO IMPROVE RELIABILITY, FUNCTION OR DESIGN. FAIRCHILD DOES NOT ASSUME ANY LIABILITY ARISING OUT OF THE APPLICATION OR USE OF ANY PRODUCT OR CIRCUIT DESCRIBED HEREIN; NEITHER DOES IT CONVEY ANY LICENSE UNDER ITS PATENT RIGHTS, NOR THE RIGHTS OF OTHERS.

**LIFE SUPPORT POLICY**

FAIRCHILD'S PRODUCTS ARE NOT AUTHORIZED FOR USE AS CRITICAL COMPONENTS IN LIFE SUPPORT DEVICES OR SYSTEMS WITHOUT THE EXPRESS WRITTEN APPROVAL OF THE PRESIDENT OF FAIRCHILD SEMICONDUCTOR CORPORATION. As used herein:

1. Life support devices or systems are devices or systems which, (a) are intended for surgical implant into the body, or (b) support or sustain life, and (c) whose failure to perform when properly used in accordance with instructions for use provided in the labeling, can be reasonably expected to result in a significant injury of the user.
2. A critical component in any component of a life support device or system whose failure to perform can be reasonably expected to cause the failure of the life support device or system, or to affect its safety or effectiveness.