

National Semiconductor is now part of
Texas Instruments.

Search <http://www.ti.com/> for the latest technical
information and details on our current products and services.

LM48860 Boomer® Audio Power Amplifier Series

Ground-Referenced, Ultra Low Noise, Fixed Gain Stereo Headphone Amplifier

General Description

The LM48860 is a ground referenced, fixed-gain audio power amplifier capable of delivering 40mW per channel of continuous average power into a 16Ω single-ended load with less than 1% THD+N from a 3V power supply.

The LM48860 features a new circuit technology that utilizes a charge pump to generate a negative reference voltage. This allows the outputs to be biased about ground, thereby eliminating output-coupling capacitors typically used with normal single-ended loads.

Boomer audio power amplifiers were designed specifically to provide high quality output power with a minimal amount of external components. The LM48860 does not require output coupling capacitors or bootstrap capacitors, and therefore is ideally suited for mobile phone and other low voltage applications where minimal power consumption is a primary requirement.

The LM48860 features a low-power consumption shutdown mode selectable for either channel separately. This is accomplished by driving either the $\overline{SD_RC}$ (Shutdown Right Channel) or $\overline{SD_LC}$ (Shutdown Left Channel) (or both) pins with logic low, depending on which channel is desired shutdown. Additionally, the LM48860 features an internal thermal shutdown protection mechanism.

The LM48860 contains advanced pop & click circuitry that eliminates noises which would otherwise occur during turn-on and turn-off transitions.

The LM48860 has an internal fixed gain of 1.5V/V.

Key Specifications

■ PSRR at 217Hz ($V_{DD} = 3.0V$)	80dB (typ)
■ Stereo Power Output at $V_{DD} = 3V$ $R_L = 16\Omega$, THD+N = 1%	40mW (typ)
■ Shutdown Current	0.1μA (typ)
■ Internal Fixed Gain	1.5V/V (typ)
■ Operating Voltage	2.0V to 5.5V

Features

- Fixed logic levels with supply voltage
- Ground referenced outputs
- High PSRR
- Available in space-saving micro SMD package
- Ultra low current shutdown mode
- Improved pop & click circuitry eliminates noises during turn-on and turn-off transitions
- No output coupling capacitors, snubber networks, bootstrap capacitors, or gain-setting resistors required
- Shutdown either channel independently

Applications

- Mobile Phones
- MP3 Players
- PDAs
- Portable electronic devices
- Notebook PCs

Typical Application

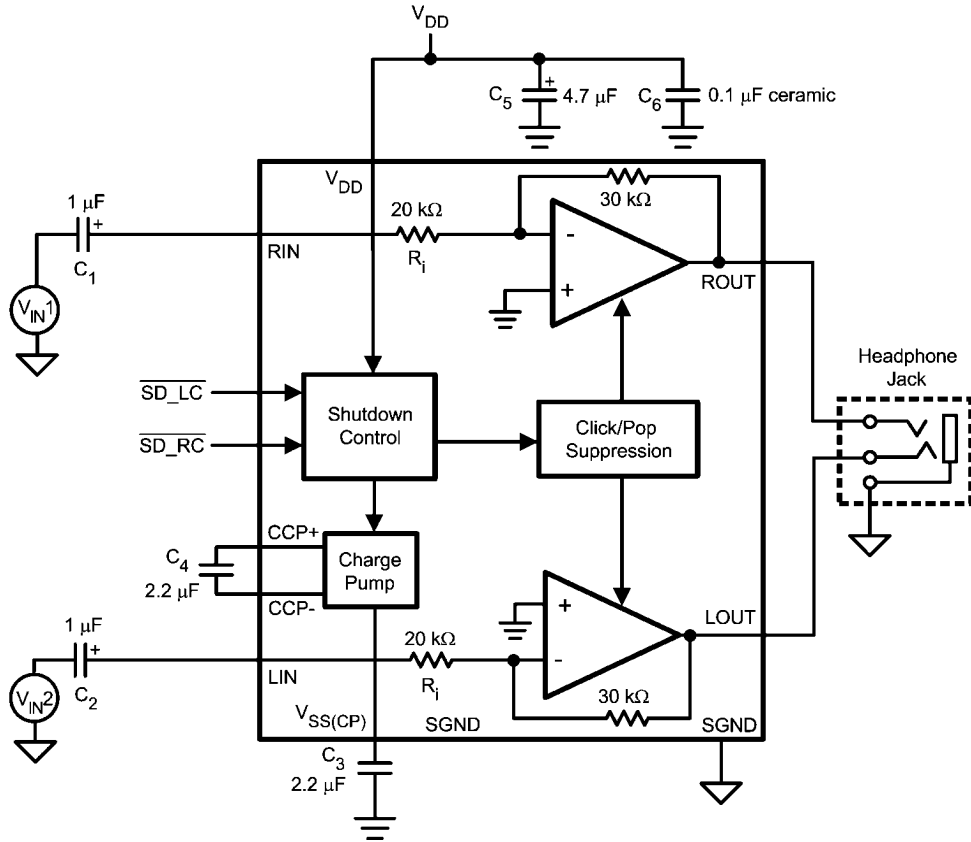

30006889

FIGURE 1. Typical Audio Amplifier Application Circuit

Connection Diagram

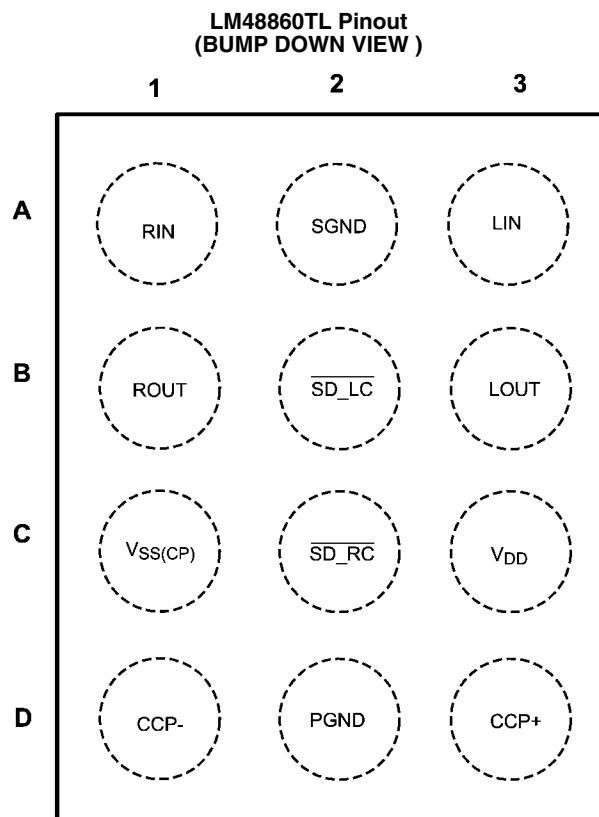

30006813

Top View
Order Number LM48860TL
See NS Package Number TLA12XXX

Pin Descriptions

Pin	Name	Function
A1	RIN	Right Channel Input
A2	SGND	Signal Ground
A3	LIN	Left Channel Input
B1	ROUT	Right Channel Output
B2	$\overline{\text{SD_LC}}$	Active Low Shutdown, Left Channel
B3	LOUT	Left Channel Output
C1	$V_{\text{SS(CP)}}$	Charge Pump Voltage Output
C2	$\overline{\text{SD_RC}}$	Active-Low Shutdown, Right Channel
C3	V_{DD}	Supply Voltage
D1	CCP-	Negative Terminal - Charge Pump Flying Capacitor
D2	PGND	Power Ground
D3	CCP+	Positive Terminal - Charge Pump Flying Capacitor

Absolute Maximum Ratings (Notes 2, 2)

If Military/Aerospace specified devices are required, please contact the National Semiconductor Sales Office/ Distributors for availability and specifications.

Supply Voltage	6.0V
Storage Temperature	-65°C to +150°C
Input Voltage	-0.3V to V_{DD}
Power Dissipation (Note 3)	Internally Limited
ESD Rating (Note 4)	2000V
ESD Rating (Note 5)	200V

Junction Temperature	150°C
Thermal Resistance	
θ_{JA} (typ) TLA12XXX	59.3°C/W

Operating Ratings

Temperature Range	
$T_{MIN} \leq T_A \leq T_{MAX}$	-40°C \leq T_A \leq 85°C
Supply Voltage (V_{DD})	2.0V \leq V_{DD} \leq 5.5V

Electrical Characteristics $V_{DD} = 3V$ (Notes 1, 2)

The following specifications apply for $V_{DD} = 3V$ and 16 Ω load unless otherwise specified. Limits apply to $T_A = 25^\circ\text{C}$.

Symbol	Parameter	Conditions	LM48860		Units (Limits)
			Typical (Note 6)	Limit (Note 7)	
I_{DD}	Quiescent Power Supply Current Full Power Mode	$V_{DD} = 3.0V$, $V_{IN} = 0V$, inputs terminated both channels enabled	4	5.5	mA (max)
		$V_{DD} = 5.0V$, $V_{IN} = 0V$, inputs terminated both channels enabled	4.2		mA
I_{SD}	Shutdown Current	SD_LC = SD_RC= GND	0.1	1	μA (max)
		SD_LC = SD_RC= GND, $V_{DD} = 5.0V$	0.1	1	μA (max)
V_{OS}	Output Offset Voltage	$R_L = 32\Omega$, $V_{IN} = 0V$	0.7	5.5	mV (max)
A_V	Voltage Gain		-1.5		V/V
ΔA_V	Channel-to-channel Gain Matching		1		%
R_{IN}	Input Resistance		20	15 25	k Ω (min) k Ω (max)
P_O	Output Power	THD+N = 1% (max); f = 1kHz, $R_L = 16\Omega$, (two channels in phase)	40	35	mW (min)
		THD+N = 1% (max); f = 1kHz, $R_L = 32\Omega$, (two channels in phase)	50	40	mW (min)
THD+N	Total Harmonic Distortion + Noise	$P_O = 20\text{mW}$, f = 1kHz, $R_L = 16\Omega$ (two channels in phase)	0.025		%
		$P_O = 25\text{mW}$, f = 1kHz, $R_L = 32\Omega$ (two channels in phase)	0.014		%
PSRR	Power Supply Rejection Ratio Full Power Mode	$V_{RIPPLE} = 200\text{mV}_{PP}$, Input Referred			
		f = 217Hz	80	73	dB (min)
		f = 1kHz	75		dB
		f = 20kHz	60		dB
SNR	Signal-to-Noise Ratio	$R_L = 32\Omega$, $P_{OUT} = 50\text{mW}$, f = 1kHz, BW = 20kHz to 22kHz, A-weighted	105		dB
V_{IH}	Shutdown Input Voltage High	$V_{DD} = 2.0V$ to 5.5V		1.2	V (min)
V_{IL}	Shutdown Input Voltage Low	$V_{DD} = 2.0V$ to 5.5V		0.45	V (max)
X_{TALK}	Crosstalk	$R_L = 16\Omega$, $P_O = 1.6\text{mW}$, f = 1kHz	75		dB
ϵ_{OS}	Output Noise	A-weighted filter, $V_{IN} = 0V$	8		μV

Symbol	Parameter	Conditions	LM48860		Units (Limits)
			Typical (Note 6)	Limit (Note 7)	
Z _{OUT}	Output Impedance	V _{SD} = GND Input Terminated			kΩ (min)
		Input not terminated SD _{LC} = SD _{RC} = GND	30 30	20	kΩ
I _L	Input Leakage		±0.1		nA

Note 1: “Absolute Maximum Ratings” indicate limits beyond which damage to the device may occur, including inoperability and degradation of device reliability and/or performance. Functional operation of the device and/or non-degradation at the *Absolute Maximum Ratings* or other conditions beyond those indicated in the *Recommended Operating Conditions* is not implied. The *Recommended Operating Conditions* indicate conditions at which the device is functional and the device should not be operated beyond such conditions. All voltages are measured with respect to the ground pin, unless otherwise specified.

Note 2: The *Electrical Characteristics* tables list guaranteed specifications under the listed *Recommended Operating Conditions* except as otherwise modified or specified by the *Electrical Characteristics Conditions* and/or Notes. Typical specifications are estimations only and are not guaranteed.

Note 3: The maximum power dissipation must be derated at elevated temperatures and is dictated by T_{JMAX}, θ_{JA}, and the ambient temperature, T_A. The maximum allowable power dissipation is P_{DMAX} = (T_{JMAX} - T_A) / θ_{JA} or the number given in *Absolute Maximum Ratings*, whichever is lower. For the LM48860, see power derating curves for additional information.

Note 4: Human body model, applicable std. JESD22-A114C.

Note 5: Machine model, applicable std. JESD22-A115-A.

Note 6: Typical values represent most likely parametric norms at T_A = +25°C, and at the Recommended Operation Conditions at the time of product characterization and are not guaranteed.

Note 7: Datasheet min/max specification limits are guaranteed by test or statistical analysis.

Note 8: θ_{JA} value is measured with the device mounted on a PCB with a 1.5" x 1.375", 1oz copper heatsink.

External Components Description

(Figure 1)

Components		Functional Description
1.	C ₁	Input coupling capacitor which blocks the DC voltage at the amplifier’s input terminals. Also creates a high pass filter with R _i at f _C = 1/(2R _i C ₁). Refer to the section Proper Selection of External Components , for an explanation of how to determine the value of C ₁ .
2.	C ₂	Input coupling capacitor which blocks the DC voltage at the amplifier’s input terminals. Also creates a high pass filter with R _i at f _C = 1/(2R _i C ₂). Refer to the Power Supply Bypassing section for an explanation of how to determine the value of C ₂ .
3.	C ₃	Output capacitor. Low ESR ceramic capacitor (≤100mΩ)
4.	C ₄	Flying capacitor. Low ESR ceramic capacitor (≤100mΩ)
5.	C ₅	Tantalum capacitor. Supply bypass capacitor which provides power supply filtering. Refer to the Power Supply Bypassing section for information concerning proper placement and selection of the supply bypass capacitor.
6.	C ₆	Ceramic capacitor. Supply bypass capacitor which provides power supply filtering. Refer to the Power Supply Bypassing section for information concerning proper placement and selection of the supply bypass capacitor.

Typical Performance Characteristics

THD+N vs Output Power
 $V_{DD} = 3V, R_L = 16\Omega$
 $f = 1kHz, 22kHz BW, one channel enabled$

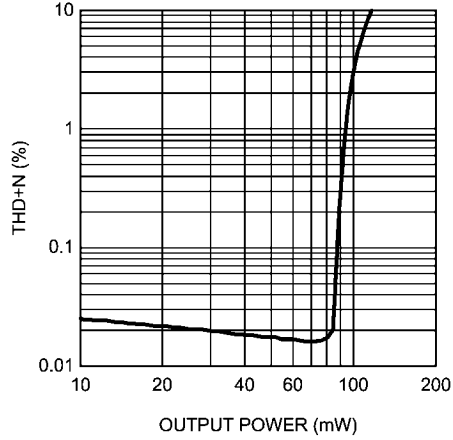

300068d2

THD+N vs Output Power
 $V_{DD} = 3V, R_L = 16\Omega, f = 1kHz$
 $22kHz BW, two channels in phase$

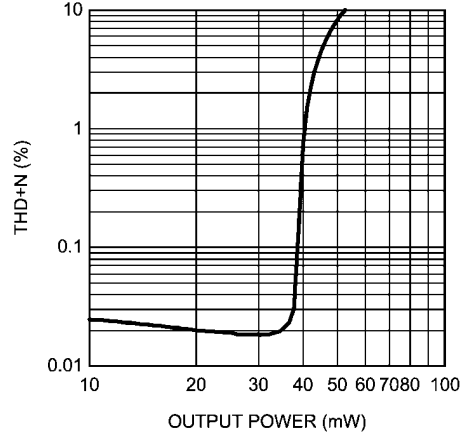

30006824

THD+N vs Output Power
 $V_{DD} = 3V, R_L = 32\Omega$
 $f = 1kHz, 22kHz BW, one channel enabled$

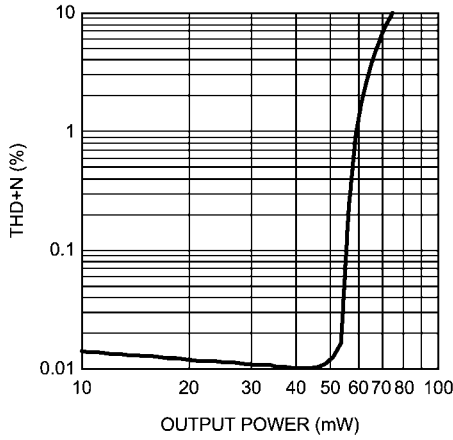

300068d3

THD+N vs Output Power
 $V_{DD} = 3V, R_L = 32\Omega, f = 1kHz$
 $22kHz BW, two channels in phase$

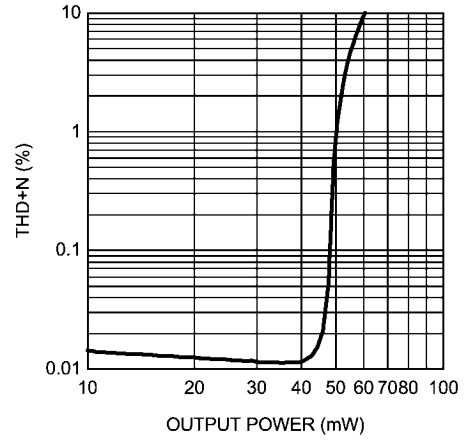

30006825

THD+N vs Output Power
 $V_{DD} = 3.6V, R_L = 16\Omega$
 $f = 1kHz, 22kHz BW, one channel enabled$

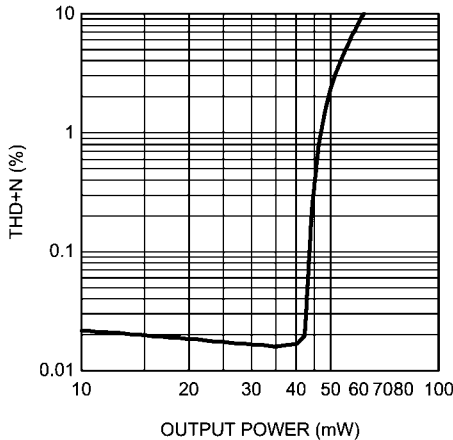

300068c8

THD+N vs Output Power
 $V_{DD} = 3.6V, R_L = 16\Omega, f = 1kHz$
 $22kHz BW, two channels in phase$

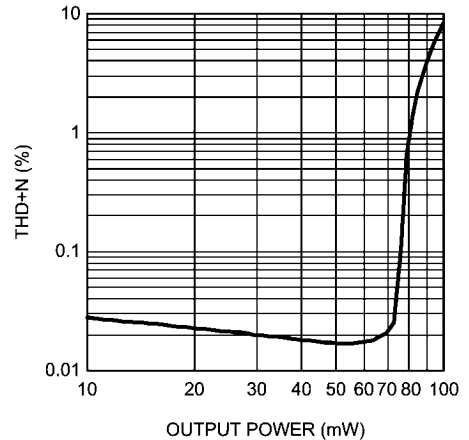

300068c9

THD+N vs Output Power
 $V_{DD} = 3.6V$, $R_L = 32\Omega$
 $f = 1kHz$, 22kHz BW, one channel enabled

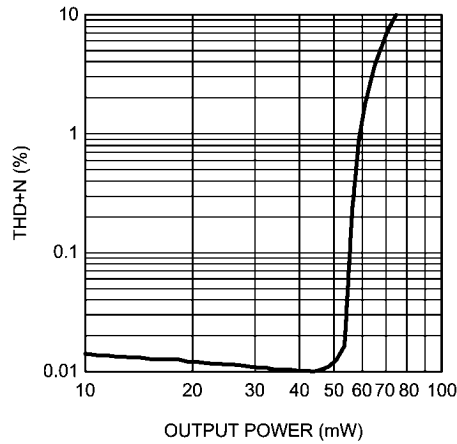

300068d0

THD+N vs Output Power
 $V_{DD} = 3.6V$, $R_L = 32\Omega$, $f = 1kHz$
 22kHz BW, two channels in phase

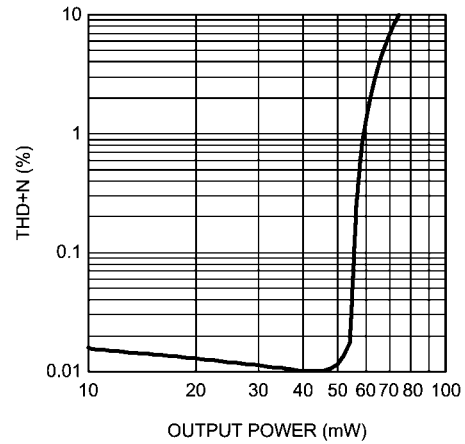

300068d1

THD+N vs Output Power
 $V_{DD} = 4.2V$, $R_L = 16\Omega$
 $f = 1kHz$, 22kHz BW, one channel enabled

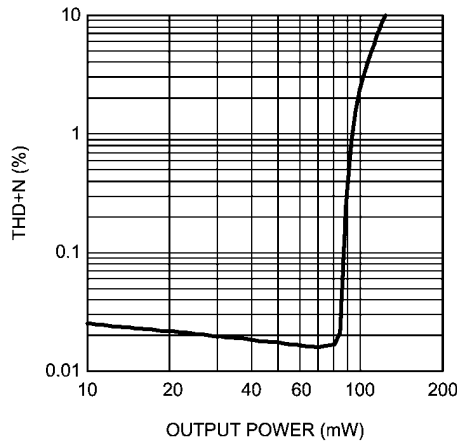

300068d4

THD+N vs Output Power
 $V_{DD} = 4.2V$, $R_L = 16\Omega$, $f = 1kHz$
 22kHz BW, two channels in phase

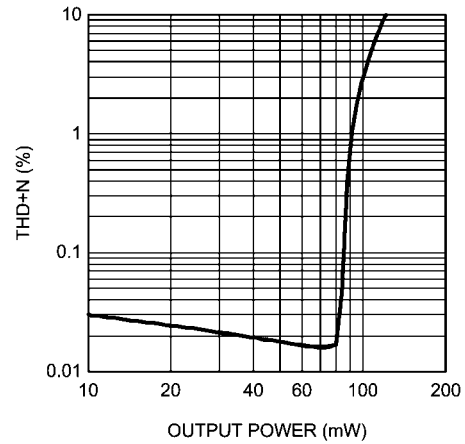

300068d5

THD+N vs Output Power
 $V_{DD} = 4.2V$, $R_L = 32\Omega$
 $f = 1kHz$, 22kHz BW, one channel enabled

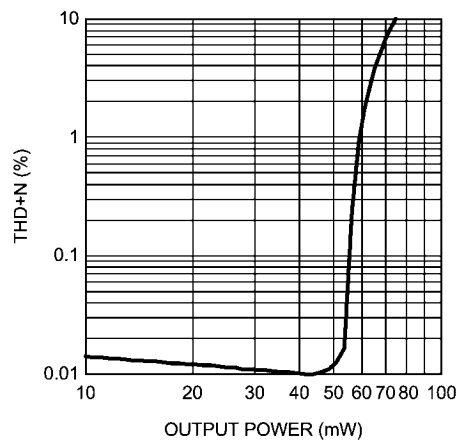

300068d6

THD+N vs Output Power
 $V_{DD} = 4.2V$, $R_L = 32\Omega$, $f = 1kHz$
 22kHz BW, two channels in phase

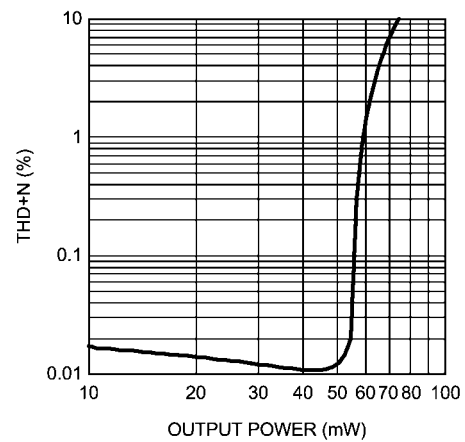

300068d7

THD+N vs Frequency
 $V_{DD} = 3V, R_L = 16\Omega$
 $P_O = 20mW, 22kHz BW$

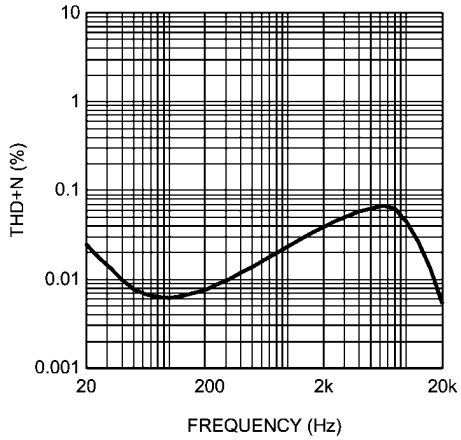

30006822

THD+N vs Frequency
 $V_{DD} = 3V, R_L = 32\Omega$
 $P_O = 20mW, 22kHz BW$

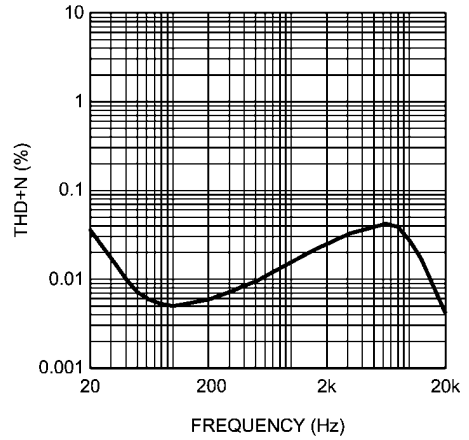

30006823

THD+N vs Frequency
 $V_{DD} = 3.6V, R_L = 16\Omega$
 $P_O = 30mW, 22kHz BW$

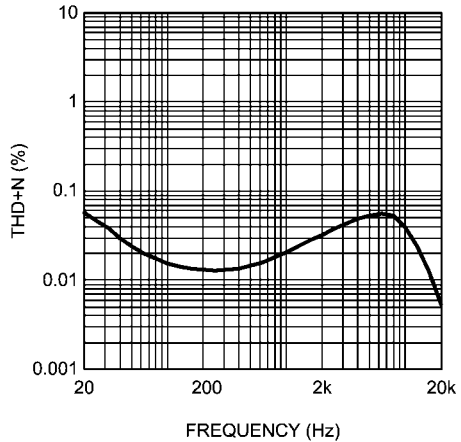

300068c4

THD+N vs Frequency
 $V_{DD} = 3.6V, R_L = 32\Omega$
 $P_O = 30mW, 22kHz BW$

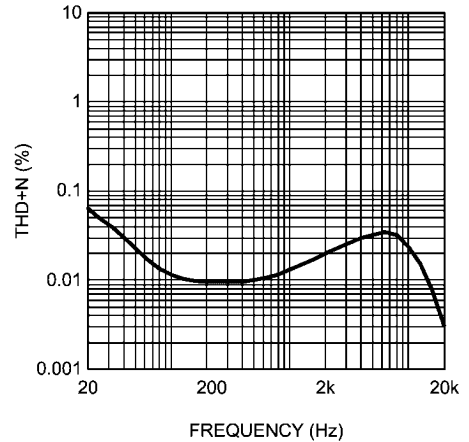

300068c5

THD+N vs Frequency
 $V_{DD} = 4.2V, R_L = 16\Omega$
 $P_O = 30mW, 22kHz BW$

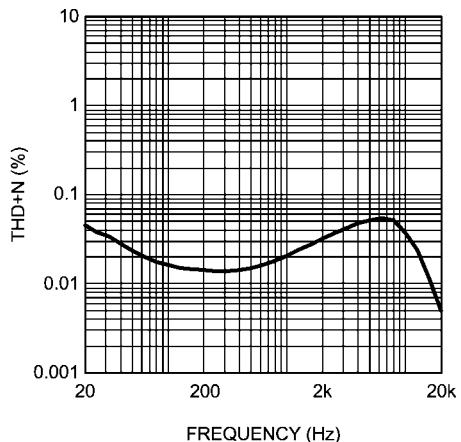

300068c6

THD+N vs Frequency
 $V_{DD} = 4.2V, R_L = 32\Omega$
 $P_O = 30mW, 22kHz BW$

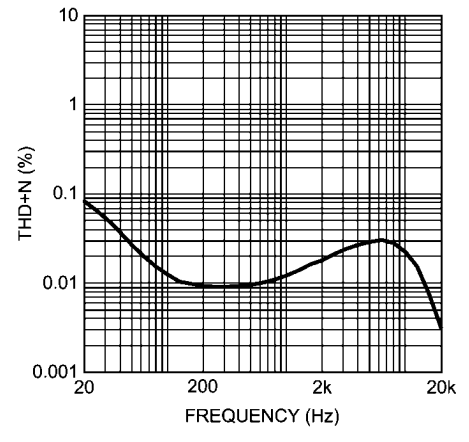

300068c7

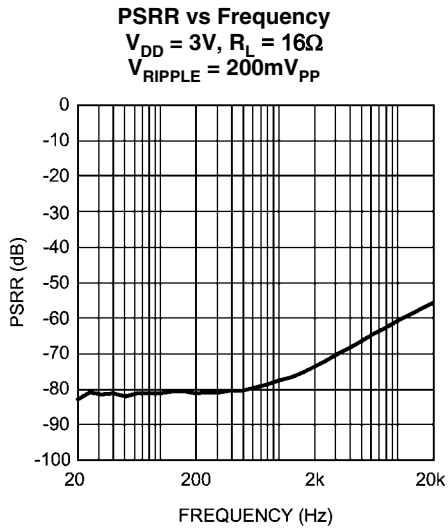

30006887

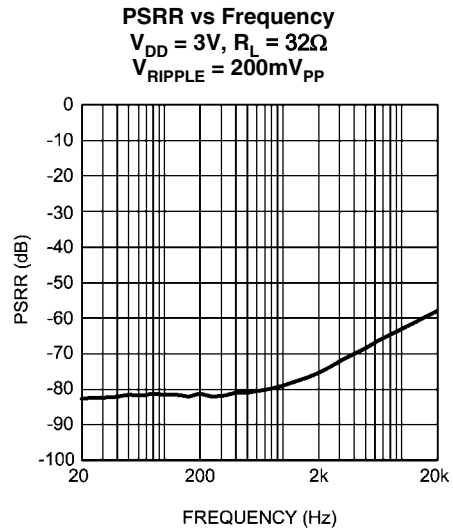

30006888

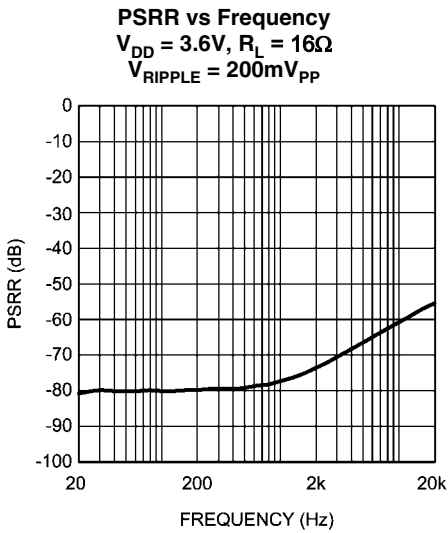

300068c0

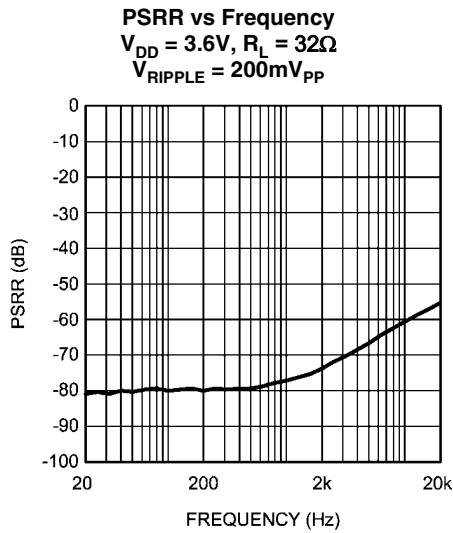

300068c1

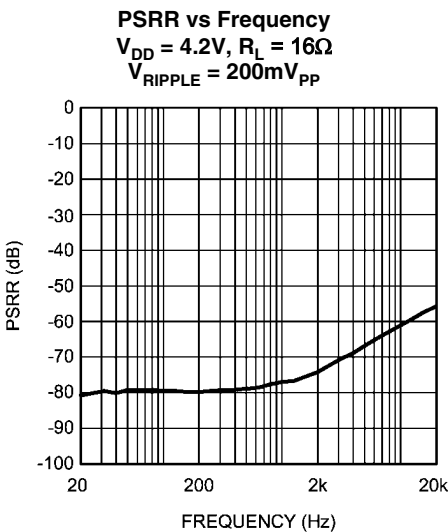

300068c2

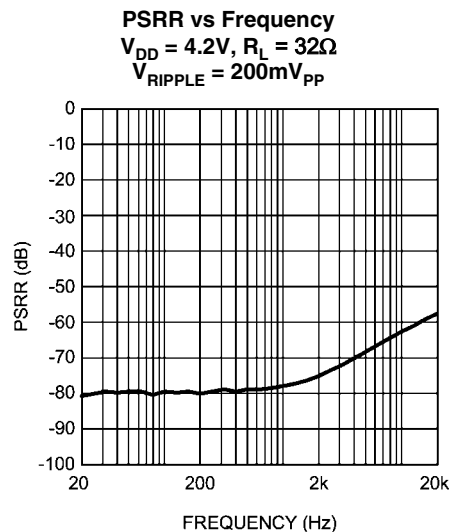

300068c3

Output Power vs Supply Voltage
 $R_L = 16\Omega$, $f = 1\text{kHz}$, 22kHz BW

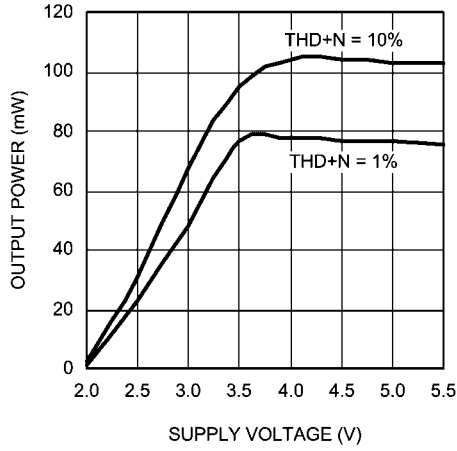

30006885

Output Power vs Supply Voltage
 $R_L = 32\Omega$, $f = 1\text{kHz}$, 22kHz BW

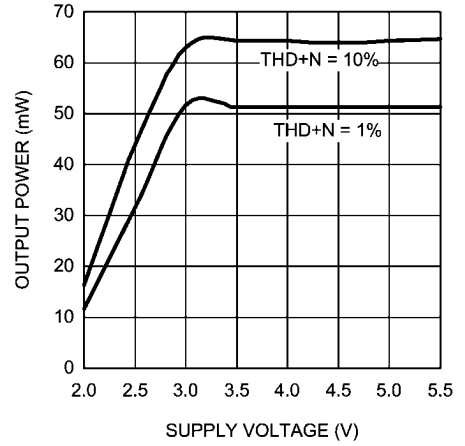

30006886

Power Dissipation vs Output Power
 $V_{DD} = 3\text{V}$, $R_L = 16\Omega$, $f = 1\text{kHz}$

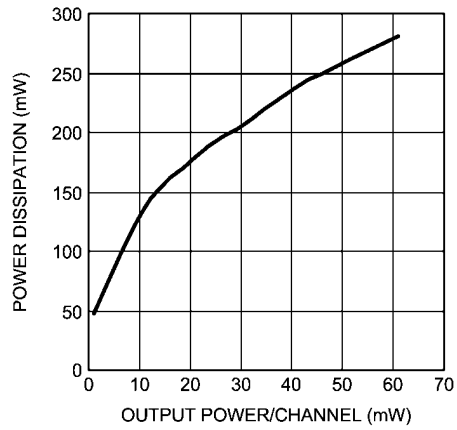

30006894

Power Dissipation vs Output Power
 $V_{DD} = 3\text{V}$, $R_L = 32\Omega$, $f = 1\text{kHz}$

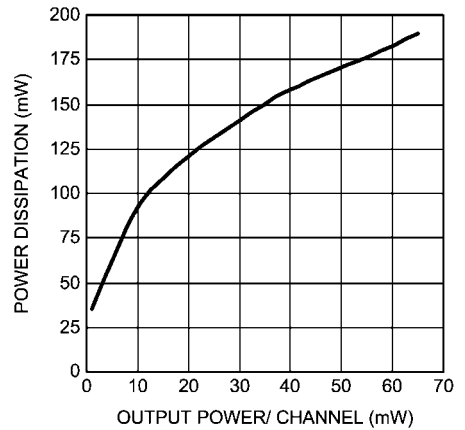

30006895

Power Dissipation vs Output Power
 $V_{DD} = 5\text{V}$, $R_L = 16\Omega$, $f = 1\text{kHz}$

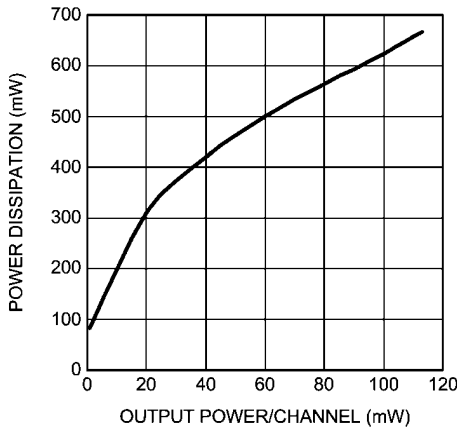

30006896

Power Dissipation vs Output Power
 $V_{DD} = 5\text{V}$, $R_L = 32\Omega$, $f = 1\text{kHz}$

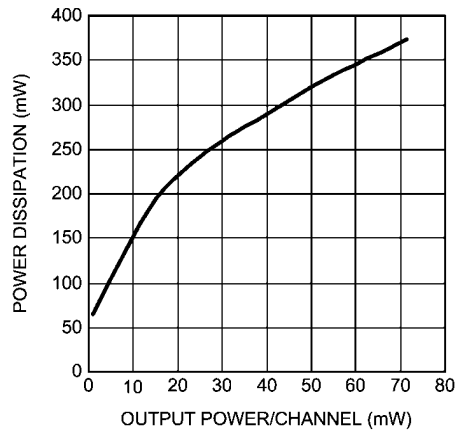

30006897

Supply Current vs Supply Voltage
 $V_{IN} = GND, \text{ No Load}$

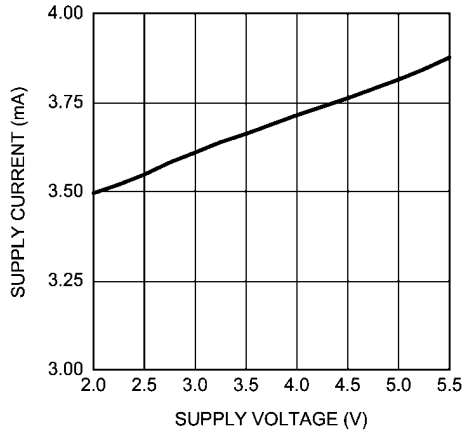

30006898

Power Derating Curve
 $V_{DD} = 3V, R_L = 16\Omega$

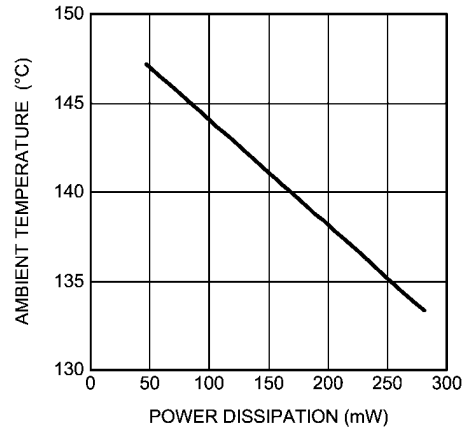

30006890

Power Derating Curve
 $V_{DD} = 3V, R_L = 32\Omega$

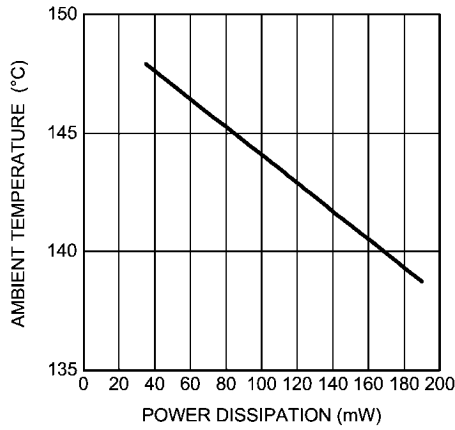

30006891

Power Derating Curve
 $V_{DD} = 5V, R_L = 16\Omega$

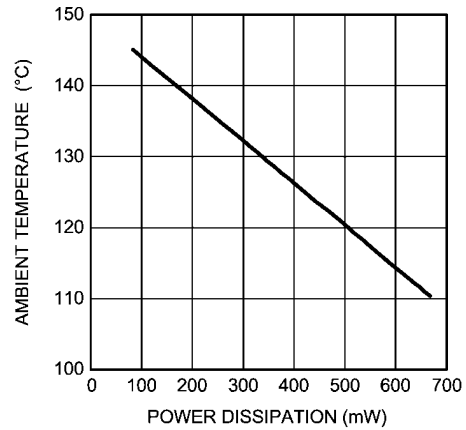

30006892

Power Derating Curve
 $V_{DD} = 5V, R_L = 32\Omega$

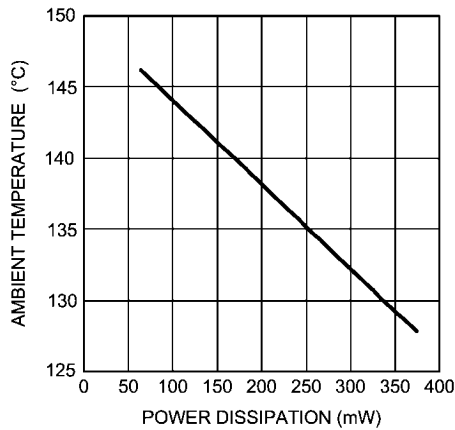

30006893

Application Information

SUPPLY VOLTAGE SEQUENCING

It is a good general practice to first apply the supply voltage to a CMOS device before any other signal or supply on other pins. This is also true for the LM48860 audio amplifier which is a CMOS device.

Before applying any signal to the inputs or shutdown pins of the LM48860, it is important to apply a supply voltage to the V_{DD} pins. After the device has been powered, signals may be applied to the shutdown pins (see MICRO POWER SHUTDOWN) and input pins.

ELIMINATING THE OUTPUT COUPLING CAPACITOR

The LM48860 features a low noise inverting charge pump that generates an internal negative supply voltage. This allows the outputs of the LM48860 to be biased about GND instead of a nominal DC voltage, like traditional headphone amplifiers. Because there is no DC component, the large DC blocking capacitors (typically 220 μ F) are not necessary. The coupling capacitors are replaced by two, small ceramic charge pump capacitors, saving board space and cost.

Eliminating the output coupling capacitors also improves low frequency response. In traditional headphone amplifiers, the headphone impedance and the output capacitor form a high pass filter that not only blocks the DC component of the output, but also attenuates low frequencies, impacting the bass response. Because the LM48860 does not require the output coupling capacitors, the low frequency response of the device is not degraded by external components.

In addition to eliminating the output coupling capacitors, the ground referenced output nearly doubles the available dynamic range of the LM48860 when compared to a traditional headphone amplifier operating from the same supply voltage.

OUTPUT TRANSIENT ('CLICK AND POPS') ELIMINATED

The LM48860 contains advanced circuitry that virtually eliminates output transients ('clicks and pops'). This circuitry prevents all traces of transients when the supply voltage is first applied or when the part resumes operation after coming out of shutdown mode.

AMPLIFIER CONFIGURATION EXPLANATION

As shown in Figure 2, the LM48860 has two internal operational amplifiers. The two amplifiers have internally configured gain.

Since this is an output ground-referenced amplifier, the LM48860 does not require output coupling capacitors.

POWER DISSIPATION

From the graph (THD+N vs Output Power, $V_{DD} = 3V$, $R_L = 16\Omega$, $f = 1kHz$, 22kHz BW, two channels in phase, page 6) assuming a 3V power supply and a 16 Ω load, the maximum power dissipation point and thus the maximum package dissipation point is 281mW. The maximum power dissipation point obtained must not be greater than the power dissipation that results from Equation 1.

$$P_{D_{MAX}} = (T_{J_{MAX}} - T_A) / (\theta_{JA}) \quad (1)$$

For the micro SMD package $\theta_{JA} = 59.3^\circ C/W$. $T_{J_{MAX}} = 150^\circ C$ for the LM48860. Depending on the ambient temperature, T_A , of the system surroundings, Equation 1 can be used to find the maximum internal power dissipation supported by the IC packaging. If the maximum power dissipation from the

graph is greater than that of Equation 1, then either the supply voltage must be decreased, the load impedance increased or T_A reduced (see power derating curves). For the application of a 5V power supply, with a 16 Ω load, the maximum ambient temperature possible without violating the maximum junction temperature is approximately 110 $^\circ C$ provided that device operation is around the maximum power dissipation point. Power dissipation is a function of output power and thus, if typical operation is not around the maximum power dissipation point, the ambient temperature may be increased accordingly.

POWER SUPPLY BYPASSING

As with any power amplifier, proper supply bypassing is critical for low noise performance and high power supply rejection. Applications that employ a 3V power supply typically use a 4.7 μ F capacitor in parallel with a 0.1 μ F ceramic filter capacitor to stabilize the power supply's output, reduce noise on the supply line, and improve the supply's transient response. Keep the length of leads and traces that connect capacitors between the LM48860's power supply pin and ground as short as possible.

MICRO POWER SHUTDOWN

The voltage applied to the $\overline{SD_LC}$ (shutdown left channel) pin and the $\overline{SD_RC}$ (shutdown right channel) pin controls the LM48860's shutdown function. When active, the LM48860's micropower shutdown feature turns off the amplifiers' bias circuitry, reducing the supply current. The trigger point is 0.45V for a logic-low level, and 1.2V for logic-high level. The low 0.01 μ A (typ) shutdown current is achieved by applying a voltage that is as near as ground a possible to the $\overline{SD_LC}/\overline{SD_RC}$ pins. A voltage that is higher than ground may increase the shutdown current. Do not let $\overline{SD_LC}/\overline{SD_RC}$ float, connect either to high or low.

SELECTING PROPER EXTERNAL COMPONENTS

Optimizing the LM48860's performance requires properly selecting external components. Though the LM48860 operates well when using external components with wide tolerances, best performance is achieved by optimizing component values.

Charge Pump Capacitor Selection

Use low ESR (equivalent series resistance) (<100m Ω) ceramic capacitors with an X7R dielectric for best performance. Low ESR capacitors keep the charge pump output impedance to a minimum, extending the headroom on the negative supply. Higher ESR capacitors result in reduced output power from the audio amplifiers.

Charge pump load regulation and output impedance are affected by the value of the flying capacitor (C4). A larger valued C4 (up to 3.3 μ F) improves load regulation and minimizes charge pump output resistance. Beyond 3.3 μ F, the switch-on resistance dominates the output impedance.

The output ripple is affected by the value and ESR of the output capacitor (C3). Larger capacitors reduce output ripple on the negative power supply. Lower ESR capacitors minimize the output ripple and reduce the output impedance of the charge pump.

The LM48860 charge pump design is optimized for 2.2 μ F, low ESR, ceramic, flying and output capacitors.

Input Capacitor Value Selection

Amplifying the lowest audio frequencies requires high value input coupling capacitors (C1 and C2 in Figure 1). A high value capacitor can be expensive and may compromise space efficiency in portable designs. In many cases, however, the

speakers used in portable systems, whether internal or external, have little ability to reproduce signals below 150Hz. Applications using speakers with this limited frequency response reap little improvement by using high value input and output capacitors.

As shown in Figure 1, the internal input resistor, R_i and the input capacitors, C1 and C2, produce a -3dB high-pass filter cutoff frequency that is found using Equation (2).

$$f_{i-3dB} = 1 / 2\pi R_{iN} C \quad (\text{Hz}) \quad (2)$$

The value of R_{iN} can be found in the *Electrical Characteristics* tables.

Demonstration Board PCB Layout

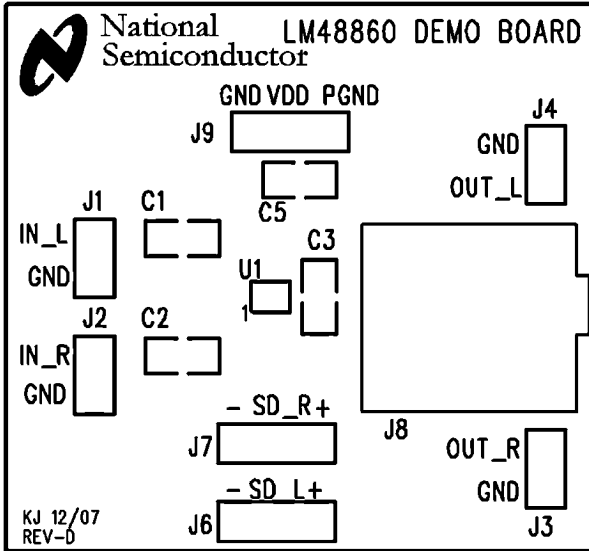

Top Silkscreen

300068a5

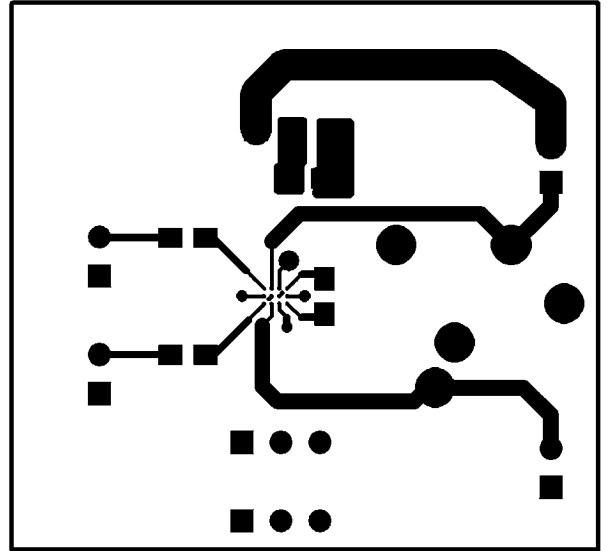

Top Layer

300068a4

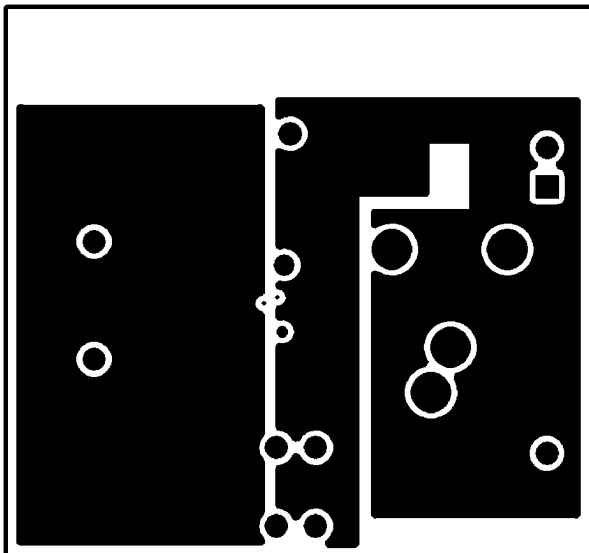

Midlayer 1

300068a2

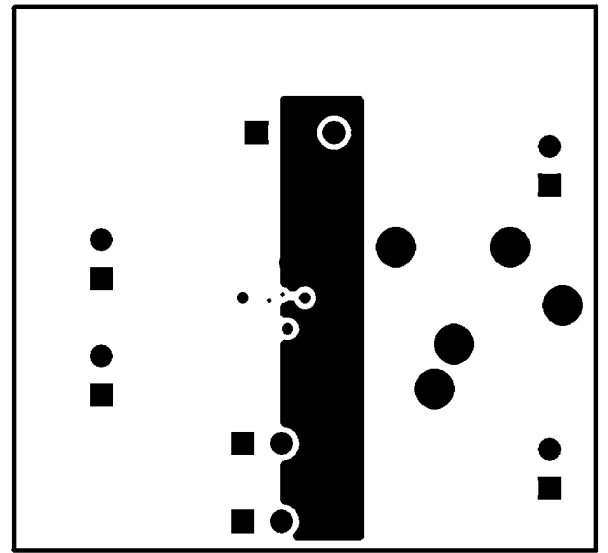

Midlayer 2

300068a3

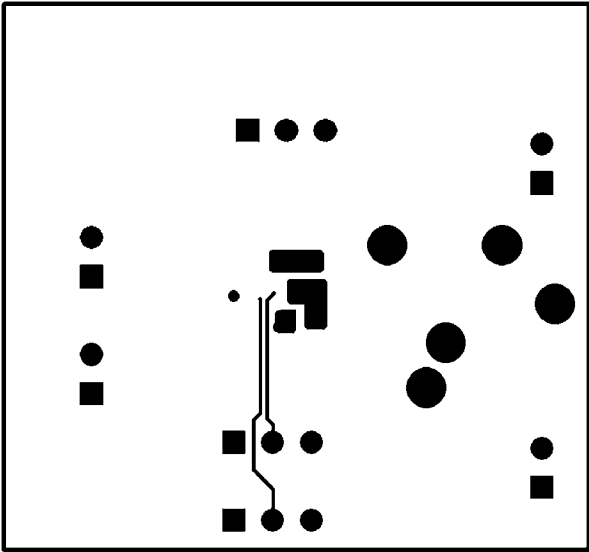

Bottom Layer

300068a0

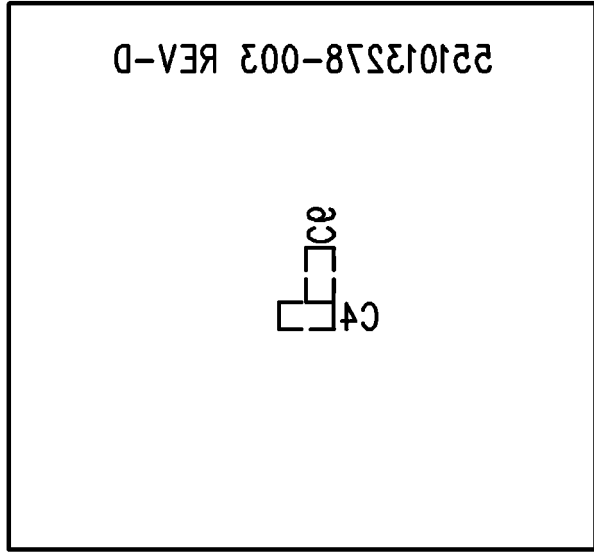

Bottom Silkscreen

300068a1

Revision History

Rev	Date	Description
1.0	01/16/08	Initial release.
1.01	01/29/08	Text edits.
1.02	02/14/08	Fixed typos (x-axis) on few curves.
1.03	10/17/08	Edited the X1 and X2 limits under the Physical Dimension section.

Physical Dimensions inches (millimeters) unless otherwise noted

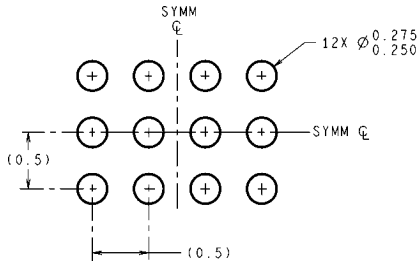

DIMENSIONS ARE IN MILLIMETERS
DIMENSIONS IN () FOR REFERENCE ONLY

LAND PATTERN RECOMMENDATION

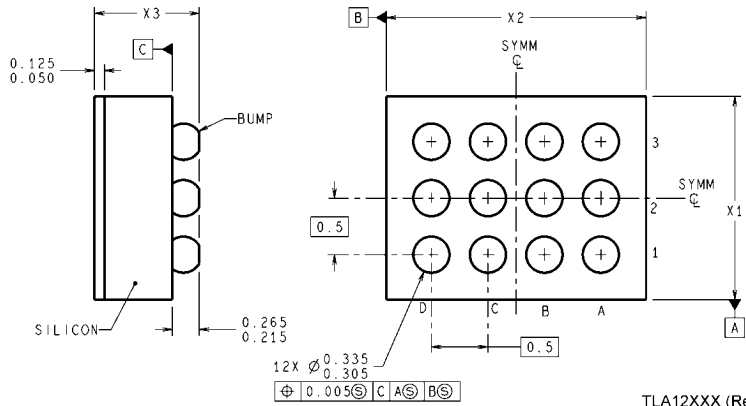
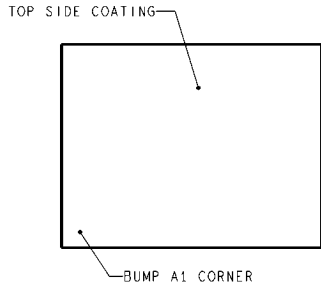

TLA12XXX (Rev C)

12 - Bump micro SMD
Order Number LM48860TL
NS Package Number TLA12XXX
X1 = 1.5±0.03mm, X2 = 2.0±0.03mm, X3 = 0.600±0.075mm,

Notes

For more National Semiconductor product information and proven design tools, visit the following Web sites at:

Products		Design Support	
Amplifiers	www.national.com/amplifiers	WEBENCH	www.national.com/webench
Audio	www.national.com/audio	Analog University	www.national.com/AU
Clock Conditioners	www.national.com/timing	App Notes	www.national.com/appnotes
Data Converters	www.national.com/adc	Distributors	www.national.com/contacts
Displays	www.national.com/displays	Green Compliance	www.national.com/quality/green
Ethernet	www.national.com/ethernet	Packaging	www.national.com/packaging
Interface	www.national.com/interface	Quality and Reliability	www.national.com/quality
LVDS	www.national.com/lvds	Reference Designs	www.national.com/refdesigns
Power Management	www.national.com/power	Feedback	www.national.com/feedback
Switching Regulators	www.national.com/switchers		
LDOs	www.national.com/lido		
LED Lighting	www.national.com/led		
PowerWise	www.national.com/powerwise		
Serial Digital Interface (SDI)	www.national.com/sdi		
Temperature Sensors	www.national.com/tempsensors		
Wireless (PLL/VCO)	www.national.com/wireless		

THE CONTENTS OF THIS DOCUMENT ARE PROVIDED IN CONNECTION WITH NATIONAL SEMICONDUCTOR CORPORATION ("NATIONAL") PRODUCTS. NATIONAL MAKES NO REPRESENTATIONS OR WARRANTIES WITH RESPECT TO THE ACCURACY OR COMPLETENESS OF THE CONTENTS OF THIS PUBLICATION AND RESERVES THE RIGHT TO MAKE CHANGES TO SPECIFICATIONS AND PRODUCT DESCRIPTIONS AT ANY TIME WITHOUT NOTICE. NO LICENSE, WHETHER EXPRESS, IMPLIED, ARISING BY ESTOPPEL OR OTHERWISE, TO ANY INTELLECTUAL PROPERTY RIGHTS IS GRANTED BY THIS DOCUMENT.

TESTING AND OTHER QUALITY CONTROLS ARE USED TO THE EXTENT NATIONAL DEEMS NECESSARY TO SUPPORT NATIONAL'S PRODUCT WARRANTY. EXCEPT WHERE MANDATED BY GOVERNMENT REQUIREMENTS, TESTING OF ALL PARAMETERS OF EACH PRODUCT IS NOT NECESSARILY PERFORMED. NATIONAL ASSUMES NO LIABILITY FOR APPLICATIONS ASSISTANCE OR BUYER PRODUCT DESIGN. BUYERS ARE RESPONSIBLE FOR THEIR PRODUCTS AND APPLICATIONS USING NATIONAL COMPONENTS. PRIOR TO USING OR DISTRIBUTING ANY PRODUCTS THAT INCLUDE NATIONAL COMPONENTS, BUYERS SHOULD PROVIDE ADEQUATE DESIGN, TESTING AND OPERATING SAFEGUARDS.

EXCEPT AS PROVIDED IN NATIONAL'S TERMS AND CONDITIONS OF SALE FOR SUCH PRODUCTS, NATIONAL ASSUMES NO LIABILITY WHATSOEVER, AND NATIONAL DISCLAIMS ANY EXPRESS OR IMPLIED WARRANTY RELATING TO THE SALE AND/OR USE OF NATIONAL PRODUCTS INCLUDING LIABILITY OR WARRANTIES RELATING TO FITNESS FOR A PARTICULAR PURPOSE, MERCHANTABILITY, OR INFRINGEMENT OF ANY PATENT, COPYRIGHT OR OTHER INTELLECTUAL PROPERTY RIGHT.

LIFE SUPPORT POLICY

NATIONAL'S PRODUCTS ARE NOT AUTHORIZED FOR USE AS CRITICAL COMPONENTS IN LIFE SUPPORT DEVICES OR SYSTEMS WITHOUT THE EXPRESS PRIOR WRITTEN APPROVAL OF THE CHIEF EXECUTIVE OFFICER AND GENERAL COUNSEL OF NATIONAL SEMICONDUCTOR CORPORATION. As used herein:

Life support devices or systems are devices which (a) are intended for surgical implant into the body, or (b) support or sustain life and whose failure to perform when properly used in accordance with instructions for use provided in the labeling can be reasonably expected to result in a significant injury to the user. A critical component is any component in a life support device or system whose failure to perform can be reasonably expected to cause the failure of the life support device or system or to affect its safety or effectiveness.

National Semiconductor and the National Semiconductor logo are registered trademarks of National Semiconductor Corporation. All other brand or product names may be trademarks or registered trademarks of their respective holders.

Copyright© 2008 National Semiconductor Corporation

For the most current product information visit us at www.national.com



National Semiconductor Americas Technical Support Center
Email: support@nsc.com
Tel: 1-800-272-9959

National Semiconductor Europe Technical Support Center
Email: europe.support@nsc.com
German Tel: +49 (0) 180 5010 771
English Tel: +44 (0) 870 850 4288

National Semiconductor Asia Pacific Technical Support Center
Email: ap.support@nsc.com

National Semiconductor Japan Technical Support Center
Email: jpn.feedback@nsc.com