

November 1996

## 4MHz, High Supply Voltage Operational Amplifiers

### Features

- Output Voltage Swing .....  $\pm 35V$
- Supply Voltage .....  $\pm 10V$  to  $\pm 40V$
- Offset Current .....  $5nA$
- Bandwidth .....  $4MHz$
- Slew Rate .....  $5V/\mu s$
- Common Mode Input Voltage Range .....  $\pm 35V$
- Output Overload Protection

### Applications

- Industrial Control Systems
- Power Supplies
- High Voltage Regulators
- Resolver Excitation
- Signal Conditioning

### Ordering Information

PART NUMBER	TEMP. RANGE (°C)	PACKAGE	PKG. NO.
HA2-2640-2	-55 to 125	8 Pin Metal Can	T8.C
HA2-2645-5	0 to 75	8 Pin Metal Can	T8.C
HA7-2640-2	-55 to 125	8 Ld CERDIP	F8.3A
HA7-2645-5	0 to 75	8 Ld CERDIP	F8.3A

### Description

HA-2640 and HA-2645 are monolithic operational amplifiers which are designed to deliver unprecedented dynamic specifications for a high voltage internally compensated device. These dielectrically isolated devices offer very low values for offset voltage and offset current coupled with large output voltage swing and common mode input voltage.

For maximum reliability, these amplifiers offer unconditional output overload protection through current limiting and a chip temperature sensing circuit. This sensing device turns the amplifier "off", when the chip reaches a certain temperature level.

These amplifiers deliver  $\pm 35V$  common mode input voltage range,  $\pm 35V$  output voltage swing, and up to  $\pm 40V$  supply range for use in such designs as regulators, power supplies, and industrial control systems.  $4MHz$  gain bandwidth and  $5V/\mu s$  slew rate make these devices excellent components for high performance signal conditioning applications. Outstanding input and output voltage swings coupled with a low  $5nA$  offset current make these amplifiers excitation designs.

**3**  
OPERATIONAL AMPLIFIERS

### Pinouts

HA-2640/2645  
(CERDIP)  
TOP VIEW

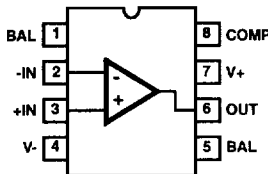

HA-2640/2645  
(METAL CAN)  
TOP VIEW

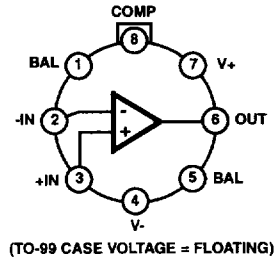

## HA-2640, HA-2645

### Absolute Maximum Ratings

Voltage Between V+ and V- Terminals	100V
Differential Input Voltage Range	37V
Output Current	Full Short Circuit Protection

### Operating Conditions

Temperature Range	
HA-2640-2	-55°C to 125°C
HA-2645-5	0°C to 75°C

### Thermal Information

Thermal Resistance (Typical, Note 1)	$\theta_{JA}$ (°C/W)	$\theta_{JC}$ (°C/W)
CERDIP Package	135	50
Metal Can Package	165	80
Maximum Junction Temperature	175°C	
Maximum Storage Temperature Range	-65°C to 150°C	
Maximum Lead Temperature (Soldering 10s)	300°C	

CAUTION: Stresses above those listed in "Absolute Maximum Ratings" may cause permanent damage to the device. This is a stress only rating and operation of the device at these or any other conditions above those indicated in the operational sections of this specification is not implied.

#### NOTE:

- $\theta_{JA}$  is measured with the component mounted on an evaluation PC board in free air.

### Electrical Specifications $V_{SUPPLY} = \pm 40V$ , $R_L = 5k\Omega$ , Unless Otherwise Specified

PARAMETER	TEST CONDITIONS	TEMP (°C)	HA-2640-2 -55°C TO 125°C			HA-2645-5 0°C TO 75°C			UNITS
			MIN	TYP	MAX	MIN	TYP	MAX	
<b>INPUT CHARACTERISTICS</b>									
Offset Voltage		25	-	2	4	-	2	6	mV
		Full		-	6	-	-	7	mV
Average Offset Voltage Drift		Full	-	15	-	-y	15	-	$\mu V/^\circ C$
Bias Current		25	-	10	25	-	12	30	nA
		Full	-	-	50	-	-	50	nA
Offset Current		25	-	5	12	-	15	30	nA
		Full	-	-	35	-	-	50	nA
Input Resistance (Note 2)		25	50	250	-	40	200	-	M $\Omega$
Common Mode Range		Full	$\pm 35$	-	-	$\pm 35$	-	-	V
<b>TRANSFER CHARACTERISTICS</b>									
Large Signal Voltage Gain	$V_{OUT} = \pm 30V$	25	100	200	-	100	200	-	kV/V
		Full	75	-	-	75	-	-	kV/V
Common Mode Rejection Ratio	$V_{CM} = \pm 20V$	Full	80	100	-	74	100	-	dB
Minimum Stable Gain		25	1	-	-	1	-	-	V/V
Unity Gain Bandwidth	$V_{OUT} = 90mV$	25	-	4	-	-	4	-	MHz
<b>OUTPUT CHARACTERISTICS</b>									
Output Voltage Swing		Full	$\pm 35$	-	-	$\pm 35$	-	-	V
Output Current	$R_L = 1k\Omega$	25	$\pm 12$	$\pm 15$	-	$\pm 10$	$\pm 12$	-	mA
Output Resistance	Open Loop	25	-	500	-	-	500	-	$\Omega$
Full Power Bandwidth (Note 3)	$V_{OUT} = \pm 35V$	25	-	23	-	-	23	-	kHz
<b>TRANSIENT RESPONSE <math>A_V = +1</math>, <math>C_L = 50pF</math>, <math>R_L = 5k\Omega</math></b>									
Rise Time	$V_{OUT} = \pm 200mV$	25	-	60	135	-	60	135	ns
Overshoot	$V_{OUT} = \pm 200mV$	25	-	15	30	-	15	40	%
Slew Rate		25	$\pm 3$	$\pm 5$	-	$\pm 2.5$	$\pm 5$	-	V/ $\mu s$
<b>POWER SUPPLY CHARACTERISTICS</b>									
Supply Current		25	-	3.2	3.8	-	3.2	4.5	mA
Supply Voltage Range		Full	$\pm 10$	-	$\pm 40$	$\pm 10$	-	$\pm 40$	V
Power Supply Rejection Ratio	$V_S = \pm 10V$ to $\pm 40V$	Full	80	90	-	74	90	-	dB

#### NOTES:

- This parameter is based upon design calculations.
- Full Power Bandwidth guaranteed based upon slew rate measurement:  $FPBW = S.R./2\pi V_{PEAK}$ ;  $V_{PEAK} = 35V$ .

Schematic Diagram

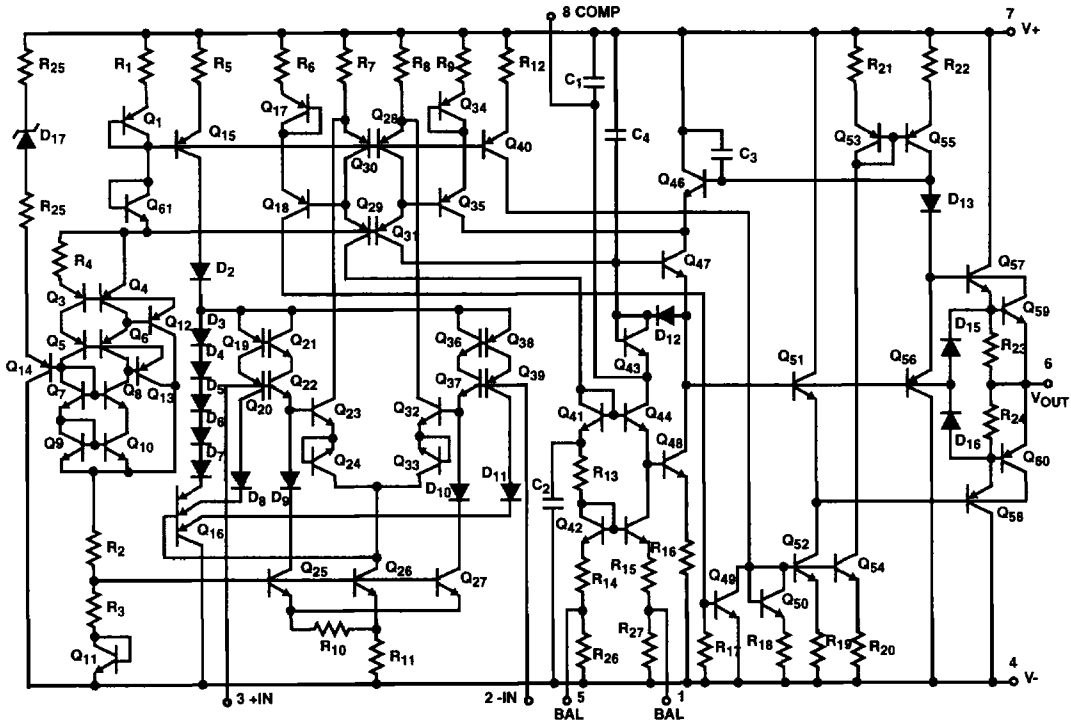

**3**  
OPERATIONAL AMPLIFIERS

Test Circuits and Waveform

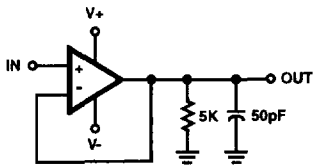
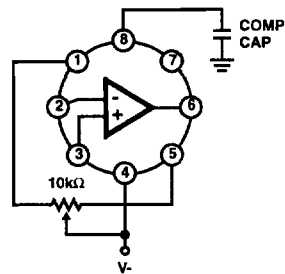

FIGURE 1. SLEW RATE AND TRANSIENT RESPONSE TEST CIRCUIT



NOTE: Tested offset adjustment range is  $|V_{OS} + 1\text{mV}|$  minimum referred to output. Typical range is  $\pm 20\text{mV}$  with  $R_T = 10\text{k}\Omega$ .

FIGURE 2. SUGGESTED  $V_{OS}$  ADJUSTMENT AND COMPENSATION HOOK UP

Test Circuits and Waveform (Continued)

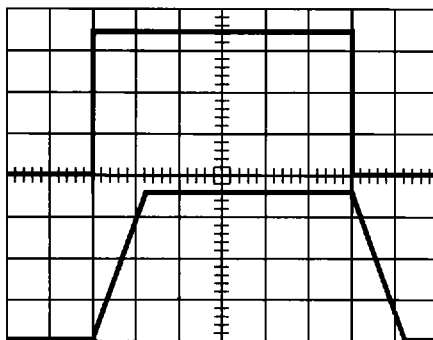

Vertical = 10V/Div., Horizontal = 5μs/Div.

NOTE:  $R_L = 5k\Omega$ ,  $C_L = 50pF$ ,  $T_A = 25^\circ C$ ,  $V_S = \pm 40V$

FIGURE 3. VOLTAGE FOLLOWER PULSE RESPONSE

Typical Performance Curves  $V_S = \pm 40V$ ,  $T_A = 25^\circ C$ , Unless Otherwise Specified

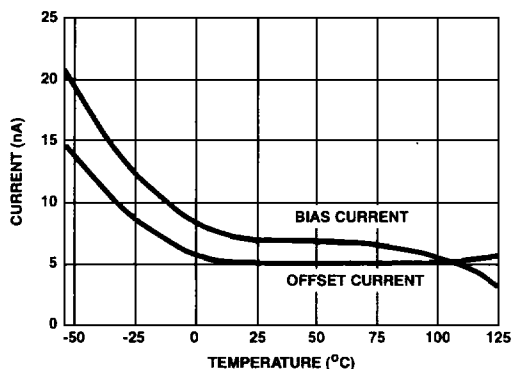

FIGURE 4. INPUT BIAS AND OFFSET CURRENT vs TEMPERATURE

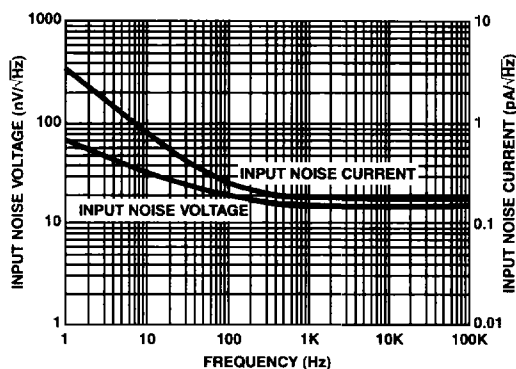

FIGURE 5. INPUT NOISE CHARACTERISTICS

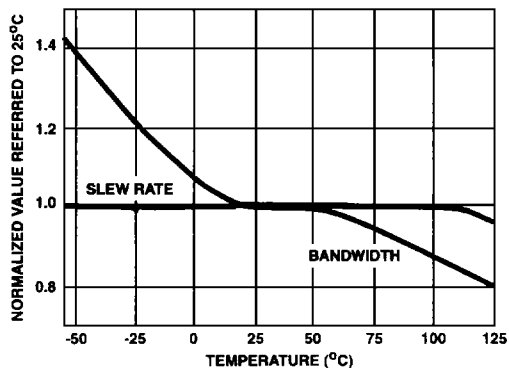

FIGURE 6. NORMALIZED AC PARAMETERS vs TEMPERATURE

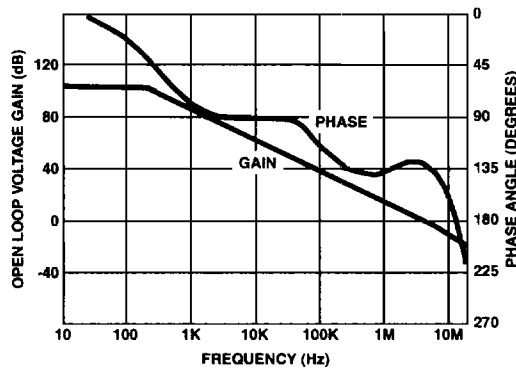

FIGURE 7. OPEN LOOP FREQUENCY RESPONSE

**Typical Performance Curves**  $V_S = \pm 40V$ ,  $T_A = 25^\circ C$ . Unless Otherwise Specified (Continued)

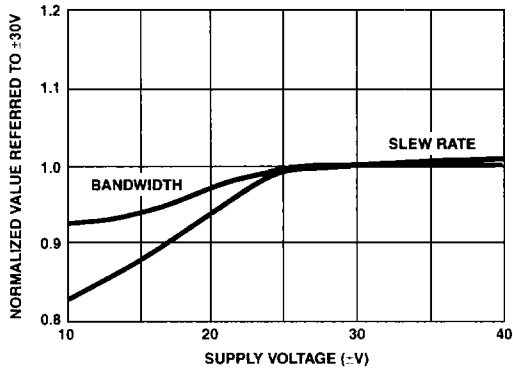

FIGURE 8. NORMALIZED AC PARAMETERS vs SUPPLY VOLTAGE AT 25°C

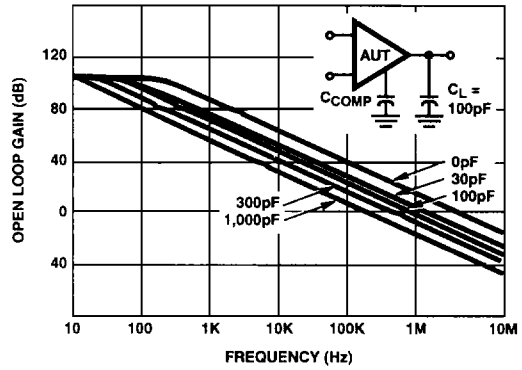

FIGURE 9. OPEN LOOP FREQUENCY RESPONSE FOR VARIOUS VALUES OF CAPACITORS FROM COMPENSATION PIN TO GROUND

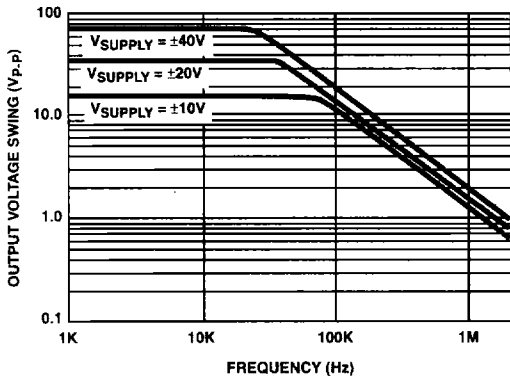

FIGURE 10. OUTPUT VOLTAGE SWING vs FREQUENCY

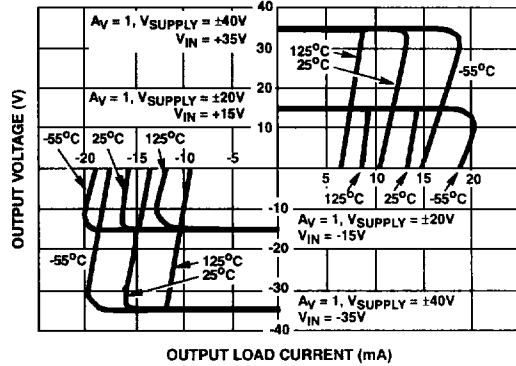

FIGURE 11. OUTPUT CURRENT CHARACTERISTIC

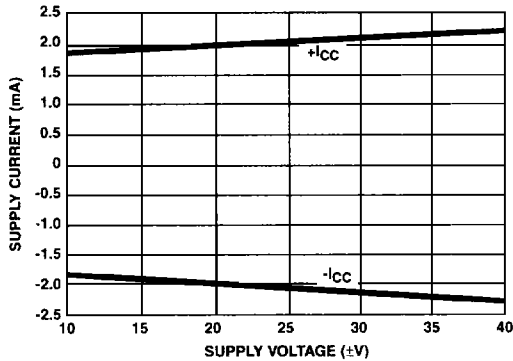

FIGURE 12. SUPPLY CURRENT vs SUPPLY VOLTAGE

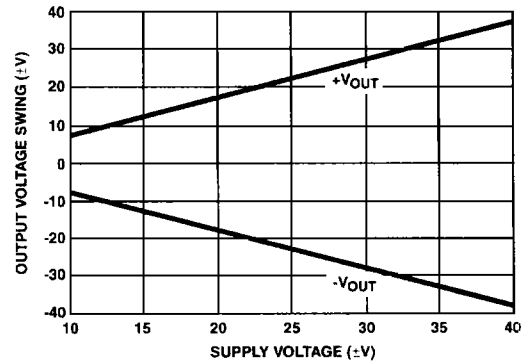

FIGURE 13. OUTPUT VOLTAGE SWING vs SUPPLY VOLTAGE

# HA-2640, HA-2645

## Die Characteristics

### DIE DIMENSIONS:

93 mils x 68 mils x 19 mils  
2360 $\mu$ m x 1720 $\mu$ m x 483 $\mu$ m

### METALLIZATION:

Type: Al, 1% Cu  
Thickness: 16k $\text{\AA}$   $\pm$  2k $\text{\AA}$

### PASSIVATION:

Type: Nitride (Si<sub>3</sub>N<sub>4</sub>) over Silox (SiO<sub>2</sub>, 5% Phos.)  
Silox Thickness: 12k $\text{\AA}$   $\pm$  2k $\text{\AA}$   
Nitride Thickness: 3.5k $\text{\AA}$   $\pm$  1.5k $\text{\AA}$

### SUBSTRATE POTENTIAL (Powered Up):

Unbiased

### TRANSISTOR COUNT:

76

### PROCESS:

HV200 Bipolar Dielectric Isolation

## Metallization Mask Layout

HA-2640, HA-2645

