

ARCHIVED BY FREESCALE SEMICONDUCTOR, INC. 2005

The MRFIC Line
GPS GaAs Low Noise Amplifier

The MRFIC1501 is a low cost yet high performance two-stage, low-noise amplifier designed primarily for use in Global Positioning Satellite System (GPS) and other L-band satellite receivers. The broadband nature of the design makes the device applicable to a variety of L-band applications where high performance at reasonable current and cost are required. Supply current is minimized through a current sharing DC cascode circuit configuration. Supply voltage can be applied to either the V_{DD} pin or the RF output pin for remote antenna applications. The integrated circuit requires minimal off-chip matching while allowing for maximum flexibility in optimizing gain and noise figure. An ENABLE pin is provided to allow for a reduced supply current standby mode. The design employs Motorola's low cost planar self-aligned MESFET process to assure repeatable characteristics at minimal cost.

- Usable Frequency Range = 1 to 2 GHz
- 18 dB Typ Gain at V_{DD} = 5 Volts
- 1.1 dB Typ Noise Figure at V_{DD} = 5 Volts
- Simple Off-chip Matching for Maximum Gain/Noise Figure Flexibility
- Single Bias Supply = 3 to 5 Volts
- Low Power Consumption = 30 mW (Typ) at 5 Volts
- Low Cost Surface Mount Plastic Package
- Order MRFIC1501R2 for Tape and Reel.
 R2 Suffix = 2,500 Units per 12 mm, 13 inch Reel.
- Device Marking = M1501

MRFIC1501

**1.6 GHz GaAs
 LOW NOISE
 AMPLIFIER**

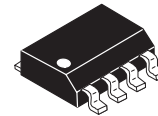

**CASE 751-06
 (SO-8)**

Freescale Semiconductor, Inc.

ARCHIVED BY FREESCALE SEMICONDUCTOR, INC. 2005

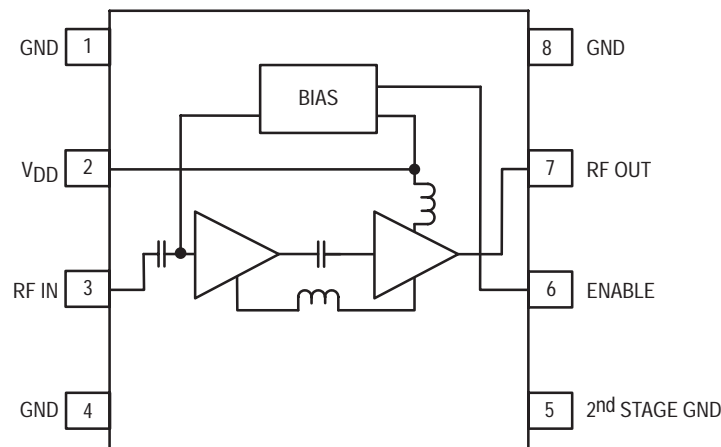

Pin Connections and Functional Block Diagram

MAXIMUM RATINGS ($T_A = 25^\circ\text{C}$ unless otherwise noted)

Ratings	Symbol	Limit	Unit
Supply Voltage	V_{DD}	6	Vdc
RF Input Power	P_{RF}	3	dBm
ENABLE Voltage	ENABLE	6	Vdc
V_{DD} Current Sourcing (With Supply Connected to Pin 7)	I_{PIN2}	20	mA
Storage Temperature Range	T_{stg}	- 65 to +150	$^\circ\text{C}$
Operating Ambient Temperature	T_A	- 30 to +100	$^\circ\text{C}$

RECOMMENDED OPERATING RANGES

Parameter	Symbol	Value	Unit
RF Frequency	f_{RF}	1 to 2	GHz
ENABLE "ON" (Device Operational) Voltage	ENABLE	$V_{DD} \pm 0.5$	Vdc
ENABLE "OFF" (Device in Standby Mode) Voltage	ENABLE	0 to 0.5	Vdc
Supply Voltage	V_{DD}	3 to 5	Vdc

ELECTRICAL CHARACTERISTICS ($V_{DD} = 5\text{ V}$, $T_A = 25^\circ\text{C}$, $R_F = 1.575\text{ GHz}$, $ENABLE = 5\text{ V}$, Circuit Configuration Shown in Figure 1)

Characteristic	Min	Typ	Max	Unit
RF Gain	17	18	—	dB
SSB Noise Figure	—	1.1	—	dB
RF Output 3rd Order Intercept Point	—	10	—	dBm
Output 1 dB Gain Compression	—	0	—	dBm
Reverse Isolation (s_{12})	—	30	—	dB
Input Return Loss	—	10	—	dB
Output Return Loss	—	10	—	dB
Supply Current	—	5.9	7.5	mA

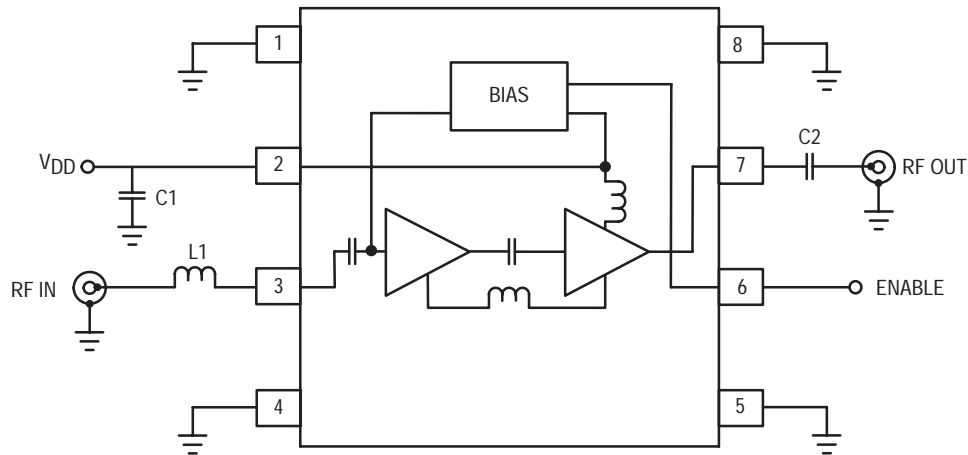

C1, C2 - 22 pF
L1 - 11 nH (Implemented in Microstrip)

Figure 1. Applications Circuit Configuration

TYPICAL CHARACTERISTICS

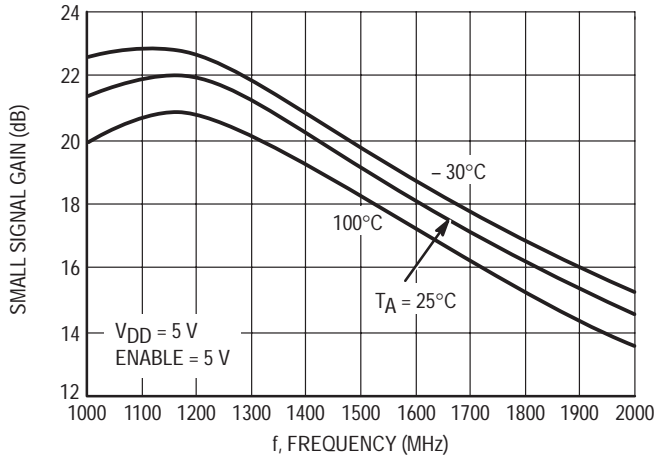

Figure 2. Small Signal Gain versus Frequency

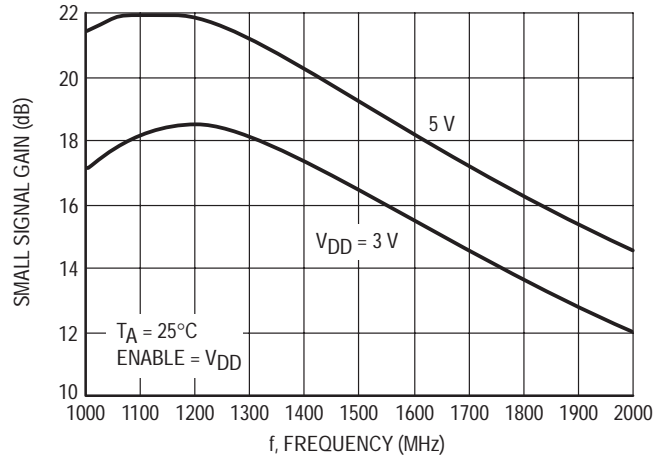

Figure 3. Small Signal Gain versus Frequency

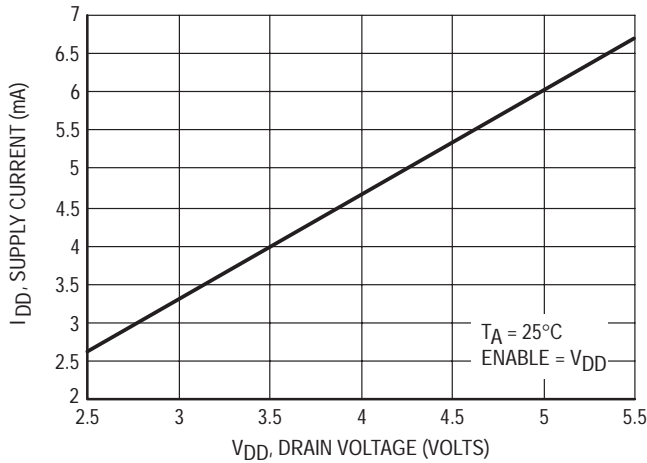

Figure 4. Drain Current versus Drain Voltage

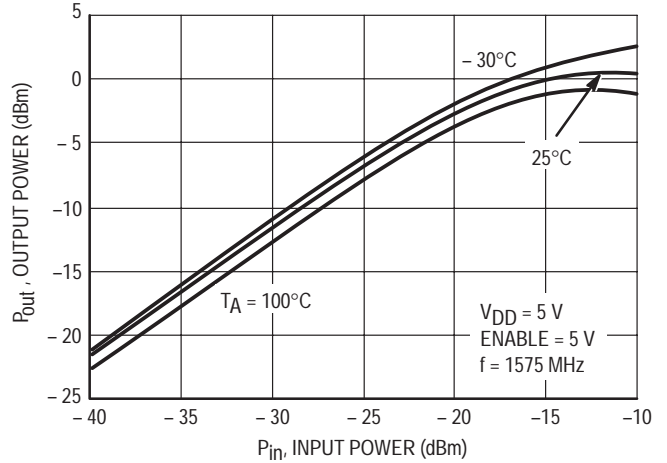

Figure 5. Output Power versus Input Power

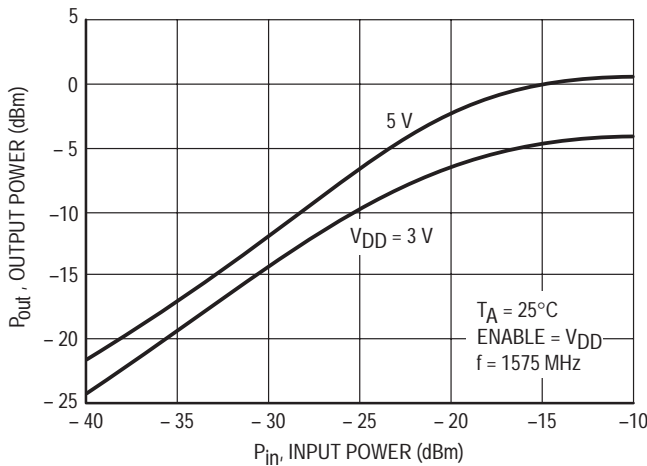

Figure 6. Output Power versus Input Power

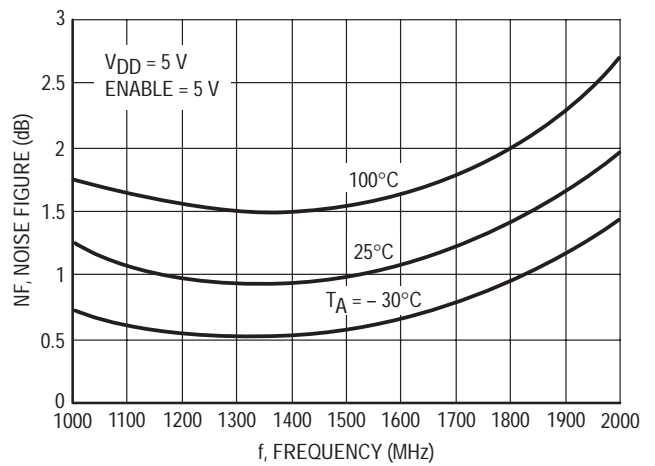

Figure 7. Noise Figure versus Frequency

TYPICAL CHARACTERISTICS

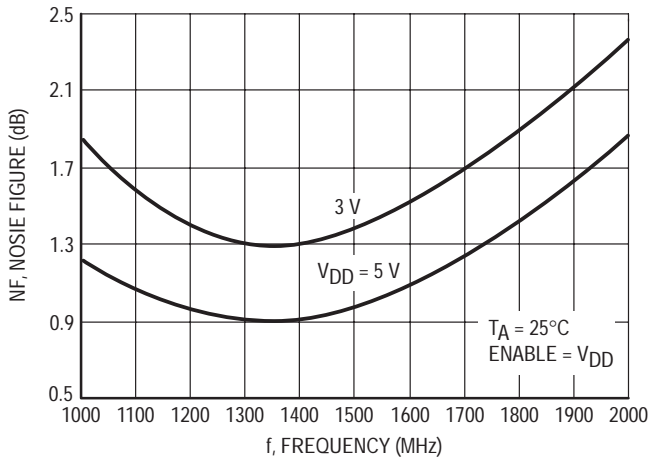

Figure 8. Noise Figure versus Frequency

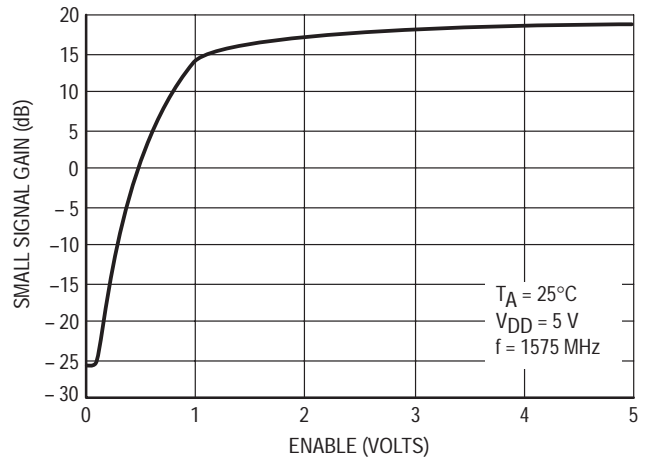

Figure 9. Gain versus ENABLE Voltage

APPLICATIONS INFORMATION

DESIGN CONSIDERATIONS

The circuit configuration employs a DC cascode arrangement which allows current sharing between two FETs. This gives excellent noise figure at reduced supply current. Since GPS applications often require the downconverter to be remotely mounted at the antenna, the output is DC coupled so that the drain voltage can be supplied through the coax feed. The V_{DD} pin can actually supply other components in the equipment at less than 20 mA of current. On-chip bias circuitry tracks changes in device threshold voltage and temperature and is externally controlled through the ENABLE pin. This feature allows for a low current standby mode or for gain reduction. Refer to Figure 9 for control characteristics.

CIRCUIT CONSIDERATIONS

As shown in Figure 1, impedance matching of the MRFIC1501 is quite simple. Through use of an on-chip

source inductor in the first stage, Γ_{opt} and Γ_{in}^* are approximately equal. A single inductor at the input will give good input match and noise figure. This inductor can be implemented with a high impedance microstrip line or a chip inductor.

As with all RF active circuit designs, bypassing the supply pin is recommended. Layout and ground via location is important. Vias should be located as close as possible to ground pins and the ground side of off-chip components.

EVALUATION BOARDS

Evaluation boards are available for RF Monolithic Integrated Circuits by adding a "TF" to the device type. For a complete list of currently available boards and ones in development for newly introduced products, please consult your local Motorola Distributor or Sales Office.

Table 1. Scattering Parameters ($V_{DD} = 3$ Volts, ENABLE = 3 Volts, 50 Ω System)

f (MHz)	S ₁₁		S ₂₁		S ₁₂		S ₂₂	
	S ₁₁	$\angle \phi$	S ₂₁	$\angle \phi$	S ₁₂	$\angle \phi$	S ₂₂	$\angle \phi$
795	0.958	-28.07	3.218	28.76	0.011	179.98	0.358	21.08
825	0.959	-29.71	3.448	23.95	0.011	176.45	0.336	15.36
855	0.954	-31.16	3.534	18.42	0.012	172.43	0.311	9.65
870	0.951	-32.04	3.535	16.03	0.011	171.06	0.297	6.67
900	0.945	-33.63	3.502	11.26	0.012	166.26	0.273	1.19
930	0.935	-35.48	3.528	6.47	0.013	166.48	0.250	-5.16
960	0.932	-37.28	3.689	2.07	0.014	164.19	0.227	-11.04
990	0.921	-39.03	3.867	-2.41	0.016	163.33	0.203	-18.26
1020	0.912	-40.69	3.954	-7.56	0.018	160.39	0.181	-25.17
1050	0.901	-42.28	3.975	-12.01	0.019	158.58	0.158	-33.18
1080	0.892	-44.16	4.039	-16.73	0.020	154.26	0.138	-40.98
1110	0.879	-46.05	4.154	-21.72	0.021	151.91	0.119	-49.98
1140	0.865	-47.91	4.296	-27.64	0.022	147.91	0.101	-58.85
1170	0.846	-49.35	4.320	-32.73	0.022	147.32	0.086	-71.10
1200	0.825	-51.34	4.224	-36.64	0.022	147.46	0.077	-87.14
1230	0.800	-51.92	4.125	-40.14	0.026	152.91	0.070	-118.39
1260	0.798	-52.57	4.224	-42.75	0.029	141.81	0.053	-155.35
1290	0.782	-53.50	4.371	-47.81	0.030	135.50	0.051	169.35
1320	0.775	-55.70	4.554	-53.11	0.031	132.76	0.049	140.94
1350	0.758	-57.05	4.525	-57.58	0.030	128.85	0.052	126.02
1380	0.742	-58.70	4.501	-61.64	0.031	125.89	0.061	114.60
1410	0.721	-60.03	4.511	-66.70	0.030	123.70	0.073	105.25
1440	0.703	-60.76	4.538	-71.38	0.031	121.40	0.083	97.32
1470	0.686	-61.48	4.553	-75.65	0.030	119.75	0.095	89.55
1500	0.668	-62.72	4.497	-79.44	0.031	116.74	0.107	82.70
1530	0.652	-63.71	4.436	-83.00	0.031	115.52	0.119	77.82
1560	0.633	-63.91	4.437	-87.36	0.030	115.29	0.132	72.37
1575	0.629	-64.01	4.458	-89.76	0.030	114.23	0.139	69.33
1590	0.621	-63.94	4.474	-91.54	0.030	112.50	0.147	66.71
1620	0.604	-64.46	4.477	-95.21	0.031	112.56	0.159	62.76
1650	0.586	-63.98	4.425	-98.51	0.030	111.63	0.172	58.00
1680	0.576	-64.45	4.330	-102.11	0.031	108.93	0.185	54.00
1710	0.559	-64.36	4.264	-105.61	0.030	106.34	0.198	50.85
1740	0.549	-64.02	4.227	-108.90	0.030	106.33	0.208	47.46
1770	0.538	-63.89	4.219	-112.08	0.030	106.56	0.222	43.54
1800	0.527	-63.69	4.172	-114.95	0.029	104.83	0.233	40.56
1830	0.523	-63.58	4.046	-118.53	0.030	104.72	0.244	37.76
1860	0.511	-62.83	3.965	-121.26	0.028	102.55	0.256	34.88
1890	0.503	-62.92	3.925	-124.29	0.029	103.12	0.266	32.47
1920	0.495	-62.26	3.917	-126.71	0.029	102.20	0.275	29.95
1950	0.485	-60.97	3.843	-129.24	0.029	102.70	0.283	27.89
1980	0.479	-60.47	3.759	-132.13	0.029	101.50	0.290	25.95
2010	0.474	-59.93	3.631	-135.13	0.027	98.87	0.300	24.27

Freescale Semiconductor, Inc.

Table 2. Scattering Parameters ($V_{DD} = 4$ Volts, $ENABLE = 4$ Volts, 50Ω System)

f (MHz)	S ₁₁		S ₂₁		S ₁₂		S ₂₂	
	S ₁₁	$\angle \phi$	S ₂₁	$\angle \phi$	S ₁₂	$\angle \phi$	S ₂₂	$\angle \phi$
900	0.927	-34.45	4.901	4.43	0.011	167.24	0.210	-4.75
930	0.915	-36.30	4.962	-0.21	0.012	166.66	0.185	-12.35
960	0.908	-38.22	5.164	-4.86	0.013	165.06	0.160	-20.80
990	0.895	-39.78	5.383	-9.68	0.015	161.65	0.135	-30.56
1020	0.883	-41.42	5.485	-14.72	0.016	158.86	0.112	-42.22
1050	0.869	-43.05	5.514	-19.31	0.017	158.43	0.092	-55.71
1080	0.858	-44.69	5.573	-24.34	0.018	155.12	0.078	-73.31
1110	0.840	-46.48	5.695	-29.10	0.019	151.63	0.068	-94.03
1140	0.822	-48.23	5.813	-35.10	0.020	149.83	0.063	-115.86
1170	0.804	-49.58	5.817	-40.03	0.020	149.25	0.066	-136.79
1200	0.783	-51.19	5.741	-43.83	0.020	149.99	0.077	-153.70
1230	0.750	-51.37	5.625	-47.36	0.023	155.59	0.102	-172.32
1260	0.753	-51.39	5.762	-49.92	0.026	144.73	0.114	165.51
1290	0.747	-52.29	5.894	-55.24	0.028	137.19	0.122	150.89
1320	0.741	-54.09	6.078	-60.53	0.028	134.63	0.123	139.00
1350	0.727	-55.80	5.998	-65.01	0.028	131.72	0.129	131.12
1380	0.709	-57.17	5.957	-68.70	0.028	128.11	0.137	124.50
1410	0.692	-58.13	5.921	-73.18	0.027	126.13	0.144	117.65
1440	0.676	-59.05	5.928	-77.75	0.027	126.40	0.153	111.32
1470	0.661	-59.68	5.909	-81.80	0.028	122.94	0.162	105.05
1500	0.641	-60.62	5.821	-85.30	0.027	122.00	0.169	98.79
1530	0.628	-61.62	5.715	-88.81	0.028	119.28	0.179	93.52
1560	0.613	-61.52	5.686	-93.11	0.028	119.11	0.190	87.97
1575	0.606	-61.90	5.667	-95.29	0.028	119.48	0.196	85.31
1590	0.599	-61.76	5.667	-97.03	0.029	117.97	0.201	82.57
1620	0.587	-62.04	5.635	-100.45	0.028	117.17	0.209	78.01
1650	0.570	-61.74	5.550	-103.32	0.027	117.04	0.222	73.51
1680	0.560	-62.07	5.423	-106.67	0.028	114.76	0.233	69.07
1710	0.543	-62.20	5.318	-110.16	0.028	112.28	0.243	65.48
1740	0.534	-61.92	5.250	-113.26	0.028	113.29	0.253	61.42
1770	0.527	-61.70	5.212	-116.15	0.028	112.91	0.264	58.10
1800	0.516	-61.84	5.146	-118.66	0.029	113.11	0.274	54.22
1830	0.511	-61.24	4.991	-121.89	0.027	112.07	0.285	50.97
1860	0.501	-60.19	4.848	-124.80	0.027	111.64	0.295	47.95
1890	0.491	-60.35	4.783	-127.80	0.027	110.45	0.304	45.16
1920	0.484	-59.86	4.747	-130.12	0.028	109.45	0.315	42.60
1950	0.474	-58.58	4.697	-132.44	0.028	109.35	0.323	40.11
1980	0.471	-58.40	4.605	-134.97	0.028	111.10	0.329	38.15
2010	0.462	-57.51	4.407	-138.30	0.026	108.25	0.339	35.69

Freescale Semiconductor, Inc.

Table 3. Scattering Parameters ($V_{DD} = 5$ Volts, ENABLE = 5 Volts, 50 Ω System)

f (MHz)	S ₁₁		S ₂₁		S ₁₂		S ₂₂	
	S ₁₁	$\angle \phi$	S ₂₁	$\angle \phi$	S ₁₂	$\angle \phi$	S ₂₂	$\angle \phi$
900	0.909	-35.17	6.271	-1.16	0.011	168.82	0.163	-11.03
930	0.892	-37.01	6.337	-6.08	0.011	165.10	0.137	-21.39
960	0.882	-38.73	6.583	-10.74	0.012	163.68	0.109	-33.61
990	0.869	-40.38	6.808	-15.88	0.014	161.24	0.088	-49.68
1020	0.855	-41.71	6.927	-21.01	0.015	160.19	0.072	-71.47
1050	0.840	-43.22	6.925	-25.76	0.016	157.93	0.065	-98.66
1080	0.828	-44.84	6.996	-30.74	0.017	156.01	0.067	-124.50
1110	0.807	-46.50	7.081	-35.59	0.018	152.69	0.076	-144.89
1140	0.791	-47.98	7.172	-41.40	0.019	151.04	0.088	-161.86
1170	0.769	-49.03	7.150	-45.93	0.019	150.32	0.103	-174.42
1200	0.745	-50.40	7.082	-49.82	0.018	149.54	0.120	178.54
1230	0.716	-49.79	6.940	-53.44	0.021	156.21	0.149	168.88
1260	0.726	-49.58	7.070	-56.18	0.024	146.99	0.165	154.85
1290	0.724	-50.16	7.183	-61.43	0.025	140.13	0.175	144.80
1320	0.721	-52.48	7.285	-66.39	0.027	136.54	0.177	136.23
1350	0.707	-54.20	7.176	-70.78	0.025	133.27	0.183	130.59
1380	0.690	-55.55	7.102	-74.39	0.026	131.27	0.191	124.77
1410	0.675	-56.53	7.006	-78.73	0.026	129.73	0.198	119.51
1440	0.660	-57.13	6.962	-82.74	0.026	127.44	0.204	113.76
1470	0.646	-57.73	6.936	-86.50	0.026	126.66	0.212	108.23
1500	0.629	-58.40	6.822	-89.92	0.026	124.54	0.219	102.92
1530	0.618	-59.69	6.687	-93.31	0.026	122.48	0.227	98.15
1560	0.601	-59.69	6.606	-97.38	0.026	121.63	0.235	93.28
1575	0.594	-59.80	6.573	-99.55	0.027	122.68	0.243	90.64
1590	0.592	-59.78	6.548	-101.29	0.027	122.13	0.246	88.16
1620	0.577	-60.13	6.477	-104.22	0.027	120.48	0.254	84.10
1650	0.562	-59.69	6.366	-106.82	0.027	119.01	0.263	79.24
1680	0.552	-60.13	6.218	-110.11	0.027	118.15	0.272	75.16
1710	0.543	-60.34	6.094	-113.45	0.026	117.67	0.282	71.64
1740	0.529	-59.65	6.000	-116.40	0.027	118.05	0.291	67.99
1770	0.523	-59.54	5.945	-119.10	0.026	116.25	0.301	64.28
1800	0.515	-59.87	5.845	-121.60	0.027	117.55	0.311	60.73
1830	0.507	-59.61	5.676	-124.69	0.027	116.91	0.320	57.22
1860	0.497	-58.77	5.488	-127.65	0.027	115.88	0.330	54.18
1890	0.491	-58.79	5.414	-130.43	0.027	114.66	0.339	51.39
1920	0.478	-58.39	5.376	-132.53	0.028	117.05	0.348	48.34
1950	0.472	-57.29	5.324	-134.66	0.029	114.84	0.356	45.85
1980	0.466	-56.94	5.193	-137.20	0.028	114.82	0.363	43.87
2010	0.461	-56.18	4.972	-140.40	0.027	114.81	0.372	41.56

Table 4. Noise Parameters ($V_{DD} = 5$ Volts, ENABLE = 5 Volts, 50 Ω System)

f (MHz)	NF _{min} (dB)	Γ_0		R _N
		MAG	$\angle \phi$	
1.000	0.8	0.859	26.36	0.98
1.575	1.0	0.793	43.87	0.70
2.000	1.3	0.713	55.80	0.56

Freescale Semiconductor, Inc.

ARCHIVED BY FREESCALE SEMICONDUCTOR, INC. 2005

PACKAGE DIMENSIONS

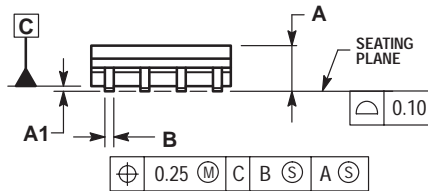
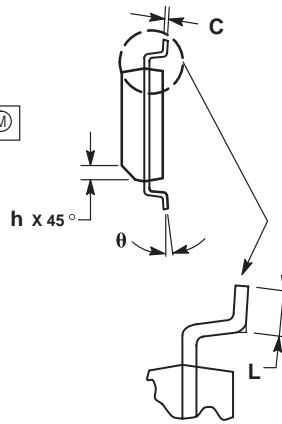
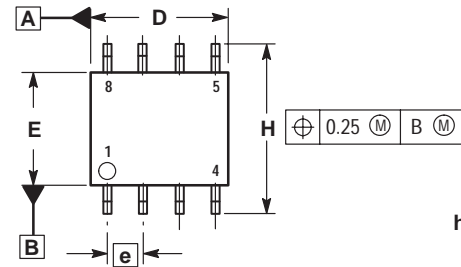

NOTES:

1. DIMENSIONING AND TOLERANCING PER ASME Y14.5M, 1994.
2. DIMENSIONS ARE IN MILLIMETER.
3. DIMENSION D AND E DO NOT INCLUDE MOLD PROTRUSION.
4. MAXIMUM MOLD PROTRUSION 0.15 PER SIDE.
5. DIMENSION B DOES NOT INCLUDE DAMBAR PROTRUSION. ALLOWABLE DAMBAR PROTRUSION SHALL BE 0.127 TOTAL IN EXCESS OF THE B DIMENSION AT MAXIMUM MATERIAL CONDITION.

DIM	MILLIMETERS	
	MIN	MAX
A	1.35	1.75
A1	0.10	0.25
B	0.35	0.49
C	0.19	0.25
D	4.80	5.00
E	3.80	4.00
e	1.27 BSC	
H	5.80	6.20
h	0.25	0.50
L	0.40	1.25
θ	0°	7°

CASE 751-06 ISSUE T

Motorola reserves the right to make changes without further notice to any products herein. Motorola makes no warranty, representation or guarantee regarding the suitability of its products for any particular purpose, nor does Motorola assume any liability arising out of the application or use of any product or circuit, and specifically disclaims any and all liability, including without limitation consequential or incidental damages. "Typical" parameters which may be provided in Motorola data sheets and/or specifications can and do vary in different applications and actual performance may vary over time. All operating parameters, including "Typicals" must be validated for each customer application by customer's technical experts. Motorola does not convey any license under its patent rights nor the rights of others. Motorola products are not designed, intended, or authorized for use as components in systems intended for surgical implant into the body, or other applications intended to support or sustain life, or for any other application in which the failure of the Motorola product could create a situation where personal injury or death may occur. Should Buyer purchase or use Motorola products for any such unintended or unauthorized application, Buyer shall indemnify and hold Motorola and its officers, employees, subsidiaries, affiliates, and distributors harmless against all claims, costs, damages, and expenses, and reasonable attorney fees arising out of, directly or indirectly, any claim of personal injury or death associated with such unintended or unauthorized use, even if such claim alleges that Motorola was negligent regarding the design or manufacture of the part. Motorola and are registered trademarks of Motorola, Inc. Motorola, Inc. is an Equal Opportunity/Affirmative Action Employer.

Mfax is a trademark of Motorola, Inc.

How to reach us:

USA/EUROPE/Locations Not Listed: Motorola Literature Distribution;
P.O. Box 5405, Denver, Colorado 80217. 1-303-675-2140 or 1-800-441-2447

JAPAN: Nippon Motorola Ltd.: SPD, Strategic Planning Office, 141,
4-32-1 Nishi-Gotanda, Shagawa-ku, Tokyo, Japan. 03-5487-8488

Customer Focus Center: 1-800-521-6274

Mfax™: RMFAX0@email.sps.mot.com – TOUCHTONE 1-602-244-6609
Motorola Fax Back System – US & Canada ONLY 1-800-774-1848
– http://sps.motorola.com/mfax/

ASIA/PACIFIC: Motorola Semiconductors H.K. Ltd.; 8B Tai Ping Industrial Park,
51 Ting Kok Road, Tai Po, N.T., Hong Kong. 852-26629298

HOME PAGE: <http://motorola.com/sps/>



MOTOROLA

For More Information On This Product,
Go to: www.freescale.com

MRFIC1501/D