

3875081 G E SOLID STATE

01E 18011 D

Unijunction Transistors and Switches

2N4987, 2N4988, 2N4989, 2N4990

T-25-09

### Silicon Unilateral Switch

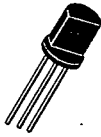

- Applications:**
- SCR Triggers
  - Frequency Drivers
  - Ring Counters
  - Cross Point Switching
  - Over-Voltage Sensors

TO-98

The GE/RCA 2N4987-90 SUSs are planar monolithic silicon integrated circuits having thyristor electrical characteristics closely approximating those of an "ideal" four layer diode. The device is designed to switch at 8 V with a 0.02%/°C temperature coefficient. A gate lead is provided to eliminate rate effect, obtain triggering information at lower voltages

and to obtain transient free wave forms.

Silicon Unilateral Switches are specifically designed and characterized for use in monostable and bistable applications where low cost is of prime importance. These types are supplied in JEDEC TO-98 package.

Devices in TO-98 package are supplied with and without seating flange (see Dimensional Outline).



**MAXIMUM RATINGS, Absolute-Maximum Values:**

PEAK REVERSE VOLTAGE .....	30 V
PEAK RECURRENT FORWARD CURRENT (1% duty cycle, 10µs pulse width, T <sub>A</sub> = 100°C) .....	1 A
PEAK NON-RECURRENT FORWARD CURRENT (10µs pulse width) .....	5 A
DC FORWARD ANODE CURRENT (Note 1) .....	175 mA
DC GATE CURRENT (Notes 1 and 2) .....	5 mA
POWER DISSIPATION (Note 1) .....	300 mW
JUNCTION TEMPERATURE RANGE .....	- 65° to + 125°C
STORAGE TEMPERATURE RANGE .....	- 65° to + 150°C

**NOTES:**

1. Derate linearly to zero at 125°C.
2. This rating applicable only in OFF state.  
Maximum gate current in conducting state limited by maximum power rating.

File Number 2049

3875081 G E SOLID STATE

01E 18012 D

Unijunction Transistors and Switches  
**2N4987, 2N4988, 2N4989, 2N4990**

T-25-09

ELECTRICAL CHARACTERISTICS, At Ambient Temperature ( $T_A$ ) = 25°C Unless Otherwise Specified

CHARACTERISTICS	SYMBOL	LIMITS												UNITS
		2N4987			2N4988			2N4989			2N4990			
		MIN.	TYP.	MAX.	MIN.	TYP.	MAX.	MIN.	TYP.	MAX.	MIN.	TYP.	MAX.	
Forward Voltage Drop (on state) ( $I_F = 175 \text{ mA}$ )	$V_F$	-	-	1.5	-	-	1.5	-	-	1.5	-	-	1.5	V
Forward Switching Voltage	$V_S$	6	-	10	7.5	-	9	7.5	-	8.2	7	-	9	V
Forward Current (off state) ( $V_F = 5 \text{ V}, T_A = 25^\circ\text{C}$ )	$I_B$	-	-	0.1	-	-	0.1	-	-	0.1	-	-	0.1	$\mu\text{A}$
( $V_F = 5 \text{ V}, T_A = 100^\circ\text{C}$ )	$I_B$	-	-	10	-	-	10	-	-	10	-	-	10	$\mu\text{A}$
Forward Switching Current	$I_S$	-	-	500	-	-	150	-	-	300	-	-	200	mA
Reverse Current ( $V_R = -30 \text{ V}, T_A = 25^\circ\text{C}$ )	$I_R$	-	-	0.1	-	-	0.1	-	-	0.1	-	-	0.1	$\mu\text{A}$
( $V_R = -30 \text{ V}, T_A = 100^\circ\text{C}$ )	$I_R$	-	-	10	-	-	10	-	-	10	-	-	10	$\mu\text{A}$
Holding Current	$I_H$	-	-	1.5	-	-	0.5	-	-	1	-	-	0.75	mA
Temperature Coefficient of Switching Voltage ( $T_A = -55^\circ\text{C}$ to $+100^\circ\text{C}$ )	$T_C$	-	$\pm 0.02$			$\pm 0.05$		$\pm 0.02$			$\pm 0.02$			%/ $^\circ\text{C}$
Turn-on Time (See Circuit 10)	$t_{on}$	-	-	1	-	-	1	-	-	1	-	-	1	$\mu\text{s}$
Turn-off Time (See Circuit 12)	$t_{off}$	-	-	25	-	-	25	-	-	25	-	-	25	$\mu\text{s}$
Peak Pulse Voltage (See Circuit 14)	$V_O$	3.5	-	-	3.5	-	-	-	-	-	-	-	-	V
Capacitance ( $0 \text{ V}, f = 1 \text{ MHz}$ )	C	-	2.5	-	-	2.5	-	-	2.5	-	-	2.5	-	pF

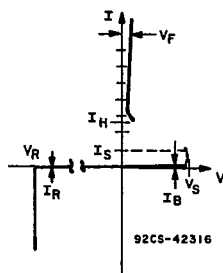

Fig. 1—Static characteristics waveform.

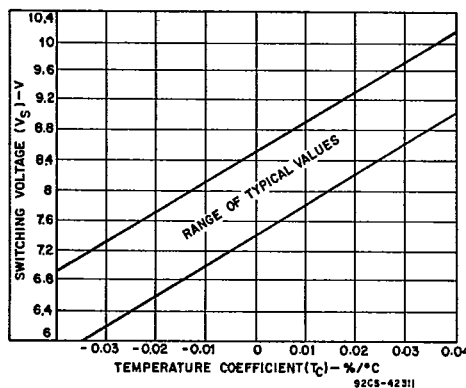

Fig. 2—Typical switching voltage characteristics.

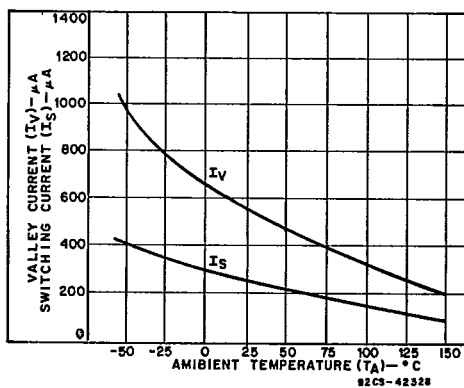

Fig. 3—Typical valley and switching current characteristics.

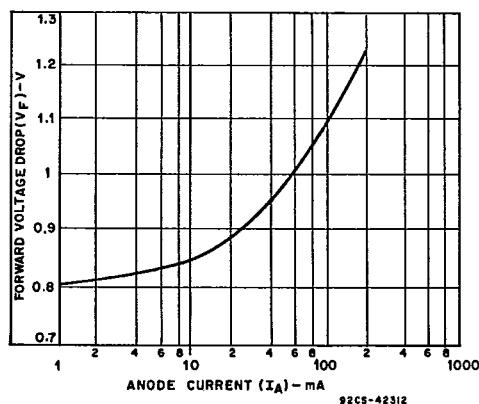

Fig. 4—Typical forward voltage drop characteristic.

Unijunction Transistors and Switches

2N4987, 2N4988, 2N4989, 2N4990

T-25-09

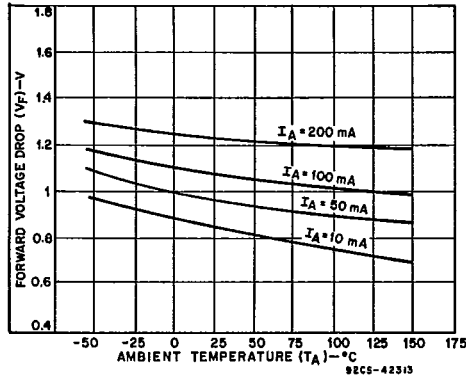

Fig. 5 - Typical forward voltage drop characteristics.

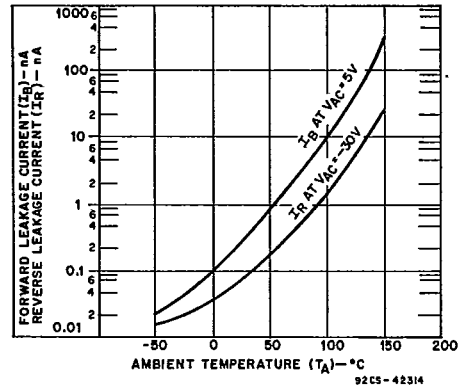

Fig. 6 - Typical forward and reverse leakage current characteristics.

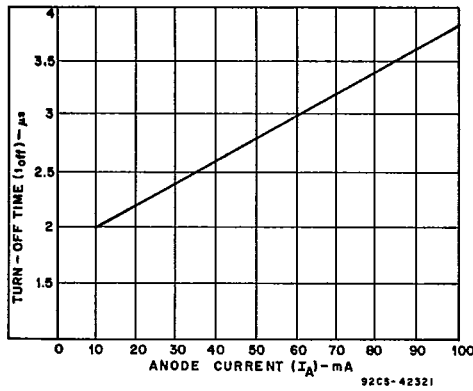

Fig. 7 - Typical turn-off time characteristics.

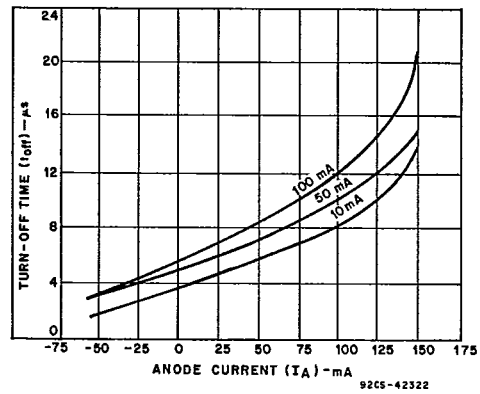

Fig. 8 - Typical turn-off time characteristics.

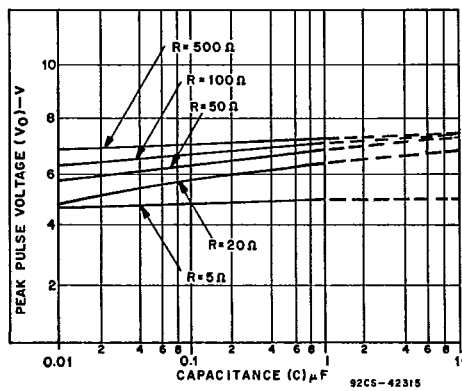

Fig. 9 - Typical peak pulse voltage characteristics. (See circuit, Fig. 12)



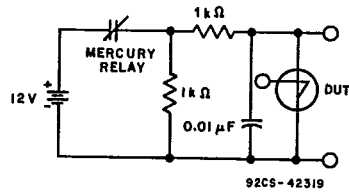

Fig. 10—Turn-on time test circuit.

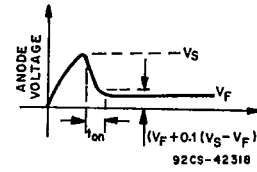

Fig. 11—Turn-on time test circuit (Fig. 10) waveform.

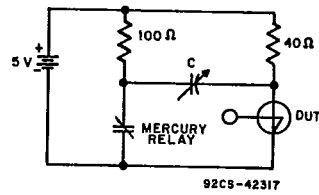

Fig. 12—Turn-off time test circuit.

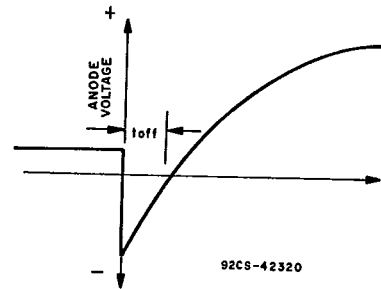

Fig. 13—Turn-off time test circuit (Fig. 12) waveform.

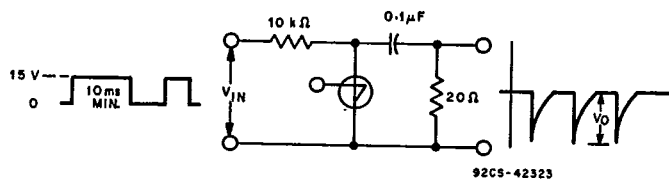

Fig. 14—Peak pulse voltage test circuit and waveforms.

Unijunction Transistors and Switches

2N4987, 2N4988, 2N4989, 2N4990

T-25-09

APPLICATIONS

Uses fewer components than transistor flip flops. Output at "B" gives transient free waveform.

Switching action of the 2N4990 allows smaller capacitors to be used while achieving reliable thyristor triggering.

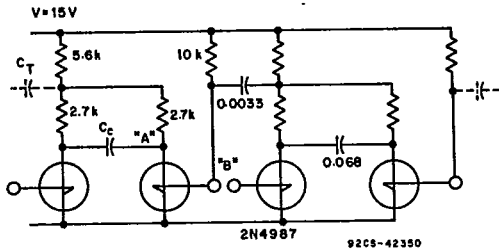

Fig. 15--Binary divider chain circuit.

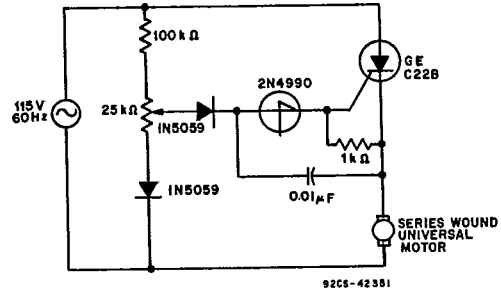

Fig. 16--Motor speed control circuit.

SUS is used to generate a rapid rise or fall time by using energy stored in a capacitor.

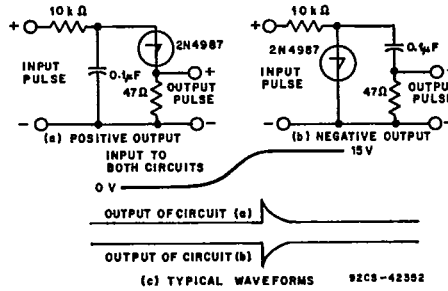

Fig. 17--Pulse sharpeners circuit.

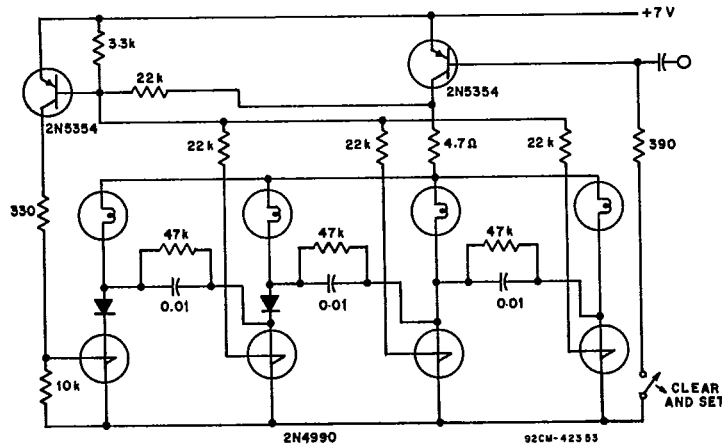

Fig. 18--Ring counter for incandescent lamps circuits.



Unijunction Transistors and Switches  
**2N4987, 2N4988, 2N4989, 2N4990**

T-25-09

APPLICATIONS (Cont'd)

For overvoltages, SCR turns on and blows fuse. For rapidly rising voltages, circuit triggers between 13.2 & 14 volts. For slowly increasing voltages, circuit triggers between 14 & 17 volts.

Capacitor charges until switching voltage is reached. When SUS switches on, inductor causes current to ring. When current thru SUS drops below holding current, device turns off and cycle repeats.

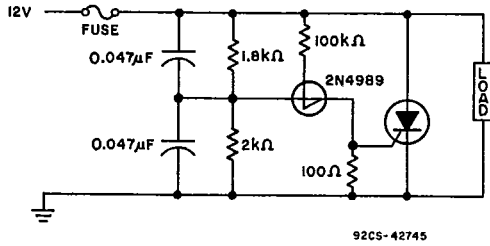

Fig. 19—Overvoltage protection circuit.

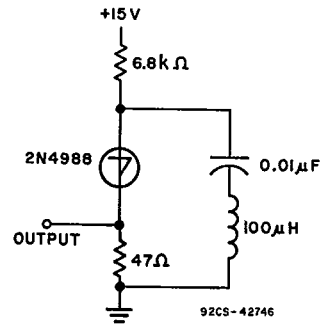

Fig. 20—10 kHz oscillator circuit.

Spikes in center of sawtooth are eliminated in this circuit by triggering at gate.

Sawtooth Output from each stage is one half frequency of preceding stage.

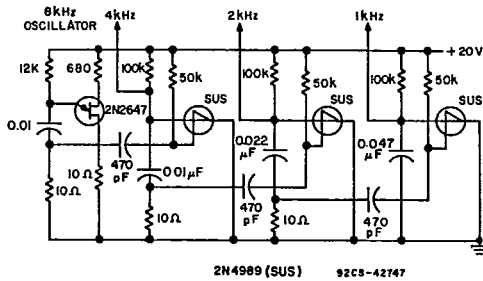

Fig. 21—Frequency divider circuit (with transient-free output).

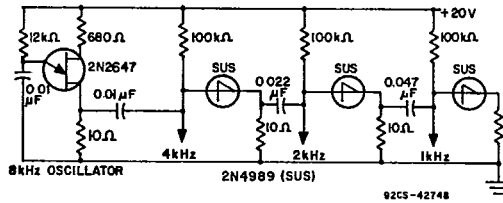

Fig. 22—Frequency divider chain circuit.

Unijunction Transistors and Switches  
2N4987, 2N4988, 2N4989, 2N4990

T. 25.09

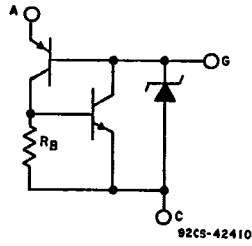

Fig. 23—Equivalent circuit.

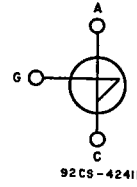

Fig. 24—Circuit Symbol.

**TERMINAL CONNECTIONS**

- Lead 1 - Anode
- Lead 2 - Gate
- Lead 3 - Cathode

