

# ADC14161

## Low-Distortion, Self-Calibrating 14-Bit, 2.5 MSPS, 390 mW A/D Converter

### General Description

The ADC14161 is a self-calibrating 14-bit, 2.5 Megasample per second analog to digital converter. It operates on a single +5V supply, consuming just 390mW (typical).

The ADC14161 provides an easy and affordable upgrade from 12 bit converters. The ADC14161 may also be used to replace many hybrid converters with a resultant saving of space, power and cost.

The ADC14161 operates with input frequencies up to 1/2 the clock frequency. The calibration feature of the ADC14161 can be used to get more consistent and repeatable results over the entire operating temperature range. On-command self-calibration reduces many of the effects of temperature-induced drift, resulting in more repeatable conversions.

Tested and guaranteed dynamic performance specifications provide the designer with known performance.

The Power Down feature reduces power consumption to less than 2mW.

The ADC14161 comes in a TQFP and is designed to operate over the industrial temperature range of -40°C to +85°C.

### Features

- Single +5V Operation
- Auto-Calibration
- Power Down Mode
- TTL/CMOS Input/Output compatible

### Key Specifications

- Resolution 14 Bits
- Conversion Rate 2.5 Msps (min)
- DNL 0.3 LSB (typ)
- SNR ( $f_{IN} = 500 \text{ kHz}$ ) 80 dB (typ)
- ENOB 12.8 Bits (typ)
- Supply Voltage +5V  $\pm 5\%$
- Power Consumption 390mW (typ)

### Applications

- Instrumentation
- PC-Based Data Acquisition
- Data Communications
- Blood Analyzers
- Sonar/Radar

### Connection Diagram

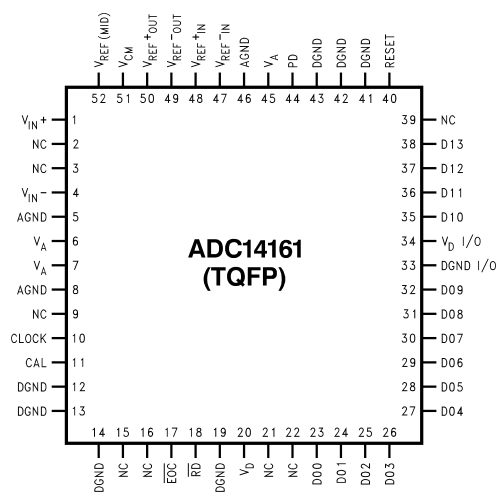

10015401

## Ordering Information

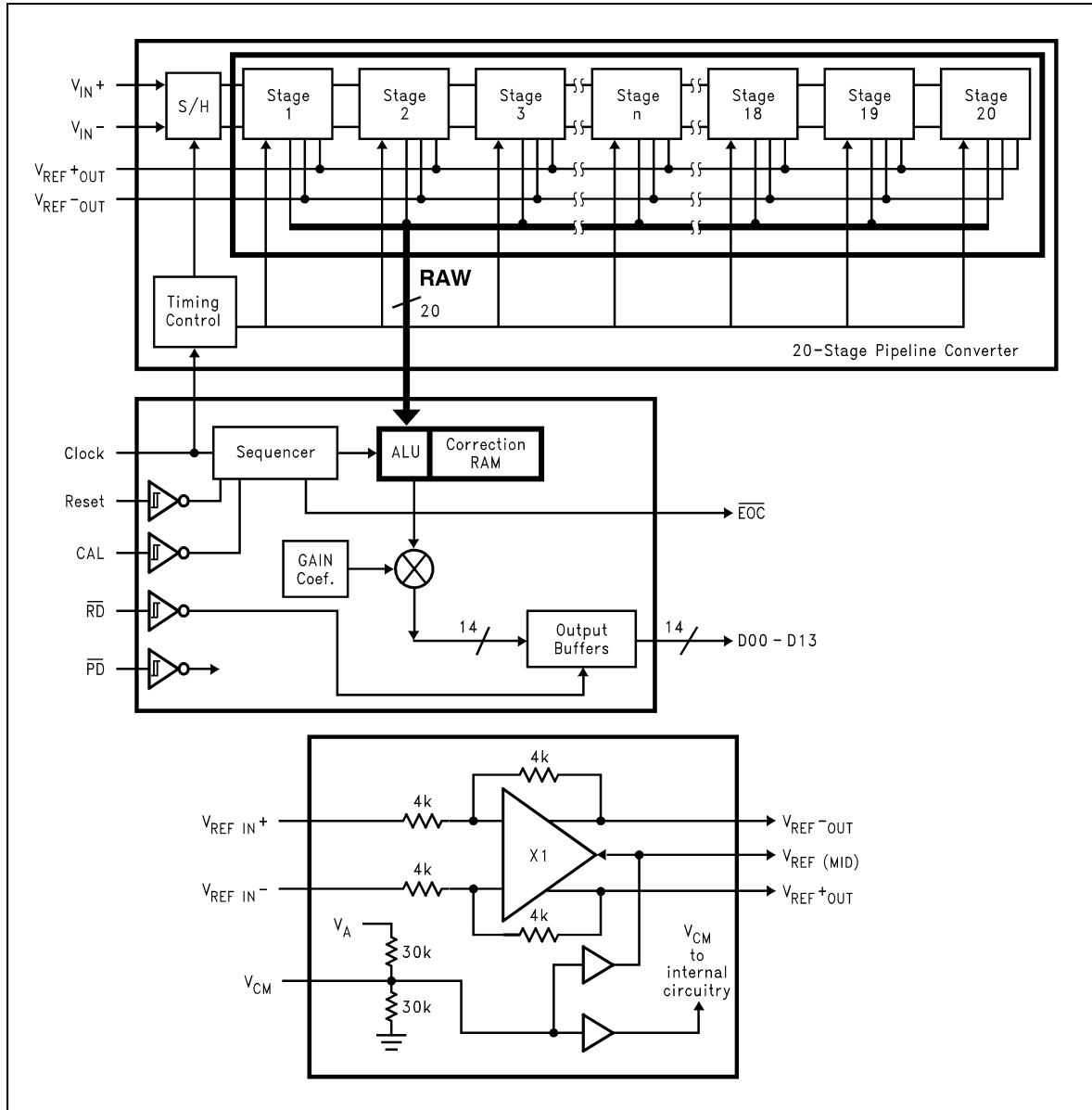

Industrial (-40°C ≤ TA ≤ +85°C)	Package
ADC14161CIVT	VEG52A 52 Pin Thin Quad Flat Pack
ADC14161EVAL	Evaluation Board

## Block Diagram

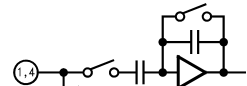

10015402

## Pin Descriptions and Equivalent Circuits

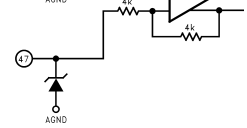
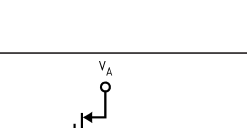
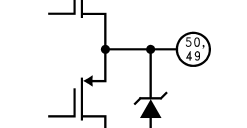
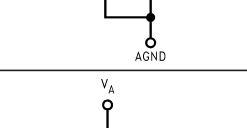
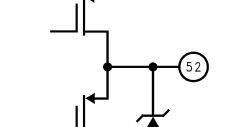
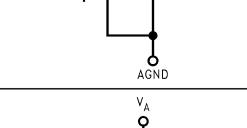
Pin No.	Symbol	Equivalent Circuit	Description
<b>Analog I/O</b>			
1	$V_{IN+}$		Non-Inverting analog signal Input. With a 2.0V reference voltage and a 2.0V common mode voltage, $V_{CM}$ , the input signal voltage range is from 1.0 volt to 3.0 Volts.
4	$V_{IN-}$		Inverting analog signal Input. With a 2.0V reference voltage and a 2.0V common mode voltage, $V_{CM}$ , the input signal voltage range is from 1.0 Volt to 3.0 Volts. The input signal should be balanced for best performance.
48	$V_{REF+ IN}$		Positive reference input. This pin should be bypassed to AGND with a 0.1 $\mu$ F monolithic capacitor. $V_{REF+ IN}$ minus $V_{REF- IN}$ should be a minimum of 1.8V and a maximum of 2.2V. The full-scale input voltage is equal to $V_{REF+ IN}$ minus $V_{REF- IN}$ .
47	$V_{REF- IN}$		Negative reference input. In most applications this pin should be connected to AGND and the full reference voltage applied to $V_{REF+ IN}$ . If the application requires that $V_{REF- IN}$ be offset from AGND, this pin should be bypassed to AGND with a 0.1 $\mu$ F monolithic capacitor. $V_{REF+ IN}$ minus $V_{REF- IN}$ should be a minimum of 1.8V and a maximum of 2.2V. The full-scale input voltage is equal to $V_{REF+ IN}$ minus $V_{REF- IN}$ .
50	$V_{REF+ OUT}$		Output of the high impedance positive reference buffer. With a 2.0V reference input, and with a $V_{CM}$ of 2.0V, this pin will have a 3.0V output voltage. This pin should be bypassed to AGND with a 0.1 $\mu$ F monolithic capacitor in parallel with a 10 $\mu$ F capacitor.
49	$REF- OUT$		The output of the negative reference buffer. With a 2.0V reference and a $V_{CM}$ of 2.0V, this pin will have a 1.0V output voltage. This pin should be bypassed to AGND with a 0.1 $\mu$ F monolithic capacitor in parallel with a 10 $\mu$ F capacitor.
52	$V_{REF (MID)}$		Output of the reference mid-point, nominally equal to 0.4 $V_A$ (2.0V). This pin should be bypassed to AGND with a 0.1 $\mu$ F monolithic capacitor. This voltage is derived from $V_{CM}$ .
51	$V_{CM}$		Input to the common mode buffer, nominally equal to 40% of the supply voltage (2.0V). This pin should be bypassed to AGND with a 0.1 $\mu$ F monolithic capacitor. Best performance is obtained if this pin is driven with a low impedance source of 2.0V.
<b>Digital I/O</b>			
10	Clock		Digital clock input. The input voltage is captured $t_{AD}$ after the fall of the clock signal. The range of frequencies for this input is 300 kHz to 2.5 MHz. The clock frequency should not be changed or interrupted during conversion or while reading data output.

## Pin Descriptions and Equivalent Circuits (Continued)

Pin No.	Symbol	Equivalent Circuit	Description
11	CAL		CAL is a level-sensitive digital input that, when pulsed high for at least two clock cycles, puts the ADC into the CALIBRATE mode. Calibration should be performed upon ADC power-up (after asserting a reset) and each time the temperature changes by more than 50°C since the ADC14161 was last calibrated. See Section 2.3 for more information.
40	RESET		RESET is a level-sensitive digital input that, when pulsed high for at least 2 CLOCK cycles, results in the resetting of the ADC. This reset pulse must be applied after ADC power-up, before calibration.
18	$\overline{RD}$		$\overline{RD}$ is the (READ) digital input that, when low, enables the output data buffers. When this input pin is high, the output data bus is in a high impedance state.
44	$\overline{PD}$		$\overline{PD}$ is the Power Down input that, when low, puts the converter into the power down mode. When this pin is high, the converter is in the active mode.
17	$\overline{EOC}$		$\overline{EOC}$ is a digital output that, when low, indicates the availability of new conversion results at the data output pins.
23-32 35-38	D00-13		Digital data outputs that make up the 14-bit TRI-STATE conversion results. D00 is the LSB, while D13 is the MSB (SIGN bit) of the two's complement output word.
<b>Analog Power</b>			
6, 7, 45	$V_A$		Positive analog supply pins. These pins should be connected to a clean, quiet +5V source and bypassed to AGND with 0.1 $\mu$ F monolithic capacitors in parallel with 10 $\mu$ F capacitors, both located within 1 cm of these power pins.
5, 8, 46	AGND		The ground return for the analog supply. AGND and DGND should be connected together directly beneath the ADC14161 package. See Section 5 (Layout and grounding) for more details).
<b>Digital Power</b>			
20	$V_D$		Positive digital supply pin. This pin should be connected to the same clean, quiet +5V source of as is $V_A$ and bypassed to DGND with a 0.1 $\mu$ F monolithic capacitor in parallel with a 10 $\mu$ F capacitor, both located within 1 cm of the power pin.
12,13 14,19 41,42 43	DGND		The ground return for the digital supply. AGND and DGND should be connected together directly beneath the ADC14161 package. See Section 5 (Layout and Grounding) for more details.

## Pin Descriptions and Equivalent Circuits (Continued)

Pin No.	Symbol	Equivalent Circuit	Description
34	V <sub>D</sub> I/O		Positive digital supply pin for the ADC14161's output drivers. This pin should be connected to a +3V to +5V source and bypassed to DGND I/O with a 0.1 $\mu$ F monolithic capacitor. If the supply for this pin is different from the supply used for V <sub>A</sub> and V <sub>D</sub> , it should also be bypassed with a 10 $\mu$ F capacitor. All bypass capacitors should be located within 1 cm of the supply pin.
33	DGND I/O		The ground return for the digital supply for the ADC14161's output drivers. This pin should be connected to the system digital ground, but not be connected in close proximity to the ADC14161's DGND or AGND pins. See Section 5.0 (Layout and Grounding) for more details.
<b>NC</b>			
2, 3, 9,15, 16,21 22,39	NC		All pins marked NC (no connect) should be left floating. Do not connect the NC pins to ground, power supplies, or any other potential or signal. These pins are used for test in the manufacturing process.

**Absolute Maximum Ratings** (Note 1)

If Military/Aerospace specified devices are required, please contact the National Semiconductor Sales Office/Distributors for availability and specifications.

Supply Voltage ( $V_A$ , $V_D$ , $V_D$ I/O)	6.5V
Voltage on Any I/O Pin	-0.3V to $V^+$ +0.3V
Input Current at Any Pin (Note 3)	$\pm 25$ mA
Package Input Current (Note 3)	$\pm 50$ mA
Power Dissipation at $T_A = 25^\circ\text{C}$	(Note 4)
ESD Susceptibility (Note 5)	
Human Body Model	1500V
Machine Model	200V
Soldering Temp., Infrared, 10 sec. (Note 6)	300°C

Storage Temperature  $-65^\circ\text{C}$  to  $+150^\circ\text{C}$

**Operating Ratings**(Notes 1, 2)

Operating Temperature Range	$-40^\circ\text{C} \leq T_A \leq +85^\circ\text{C}$
$V_A$ , $V_D$	+4.75V to +5.25V
$V_D$ I/O	2.7V to $V_D$
$V_{REF-}$ - IN	1.0V to 3.0V
$V_{REF-}$ - IN	AGND to 1.0V
Digital Inputs	$-0.05\text{V}$ to $V_D + 0.05\text{V}$
$ V_A - V_D $	$\leq 100$ mV
$ AGND - DGND $	0V to 100 mV

**Converter Electrical Characteristics**

The following specifications apply for AGND = DGND = DGND I/O = 0V,  $V^+ = V_A = V_D = +5.0\text{V}$ ,  $V_D$  I/O = 3.0V or 5.0V,  $\overline{PD} = +5\text{V}$ ,  $V_{REF+}$  - IN = +2.0V,  $V_{REF-}$  - IN = AGND,  $f_{CLK} = 2.5$  MHz,  $C_L = 50$  pF/pin. After Auto-Cal @ Temperature. **Boldface limits apply for  $T_A = T_J = T_{MIN}$  to  $T_{MAX}$** : all other limits  $T_A = T_J = 25^\circ\text{C}$ (Notes 7, 8, 9)

Symbol	Parameter	Conditions	Typical (Note 10)	Limits (Note 11)	Units
<b>Static Converter Characteristics</b>					
	Resolution with No Missing Codes			<b>14</b>	Bits(min)
INL	Integral Non Linearity		$\pm 0.75$	<b><math>\pm 2.5</math></b>	LSB(max)
DNL	Differential Non Linearity		$\pm 0.3$	<b><math>\pm 1.0</math></b>	LSB(max)
	Full-Scale Error		$\pm 0.4$	<b><math>\pm 2.8</math></b>	% FS(max)
	Zero Error		+0.1	<b><math>\pm 0.6</math></b>	% FS(max)
<b>Reference and Analog Input Characteristics</b>					
$V_{IN}$	Input Voltage Range ( $V_{IN+}$ - $V_{IN-}$ )	$V_{REF} = V_{REF+}$ - IN - $V_{REF-}$ - IN	2.0	<b>1.8</b> <b>2.2</b>	V(min) V(max)
$C_{IN}$	Input Capacitance	$V_{IN} = 1.0\text{V} + 0.7\text{V}_{rms}$	(CLK LOW)	12	pF
			(CLK HIGH)	28	pF
$V_{REF}$	Reference Voltage Range [( $V_{REF+}$ - IN) - ( $V_{REF-}$ - IN)] (Note 14)		2.00	<b>1.8</b> <b>2.2</b>	V(min) V(max)
	Reference Input Resistance		3.5		K $\Omega$
<b>Dynamic Converter Characteristics</b>					
BW	Full Power Bandwidth		45		MHz
SNR	Signal-to-Noise Ratio	$f_{IN} = 500$ kHz, $V_{IN} = 1.9\text{V}_{P-P}$	80	<b>77</b>	dB(min)
SINAD	Signal-to-Noise & Distortion	$f_{IN} = 500$ kHz, $V_{IN} = 1.9\text{V}_{P-P}$	79	<b>76</b>	dB(min)
ENOB	Effective Number of Bits	$f_{IN} = 500$ kHz, $V_{IN} = 1.9\text{V}_{P-P}$	12.8	<b>12.3</b>	Bits(min)
THD	Total Harmonic Distortion	$f_{IN} = 500$ kHz, $V_{IN} = 1.9\text{V}_{P-P}$	-88	<b>-80</b>	dB(min)
SFDR	Spurious Free Dynamic Range	$f_{IN} = 500$ kHz, $V_{IN} = 1.9\text{V}_{P-P}$	90		dB
IMD	Intermodulation Distortion	$f_{IN1} = 95$ kHz $f_{IN2} = 105$ kHz	-97		dB

## DC and Logic Electrical Characteristics

The following specifications apply for AGND = DGND = DGND I/O = 0V,  $V^+ = V_A = V_D = +5.0V$ ,  $V_D$  I/O = 3.0V or 5.0V,  $\overline{PD} = +5V$ ,  $V_{REF+} = +2.0V$ ,  $V_{REF IN} = AGND$ ,  $f_{CLK} = 2.5$  MHz,  $R_S = 25\Omega$ ,  $C_L = 50$  pF/pin. After Auto-Cal @ Temperature. **Boldface limits apply for  $T_A = T_J = T_{MIN}$  to  $T_{MAX}$** ; all other limits  $T_A = T_J = 25^\circ C$  (Notes 7, 8, 9)

Symbol	Parameter	Conditions	Typical (Note 10)	Limits (Note 11)	Units
<b>CLOCK, <math>\overline{RD}</math>, <math>\overline{PD}</math> Digital Input Characteristics</b>					
$V_{IN(1)}$	Logical "1" Input Voltage	$V^+ = 5.25V$		<b>2.0</b>	V(min)
$V_{IN(0)}$	Logical "0" Input Voltage	$V^+ = 4.75V$		<b>0.8</b>	V(max)
$I_{IN(1)}$	Logical "1" Input Current	$V_{IN} = 5.0V$	5		$\mu A$
$I_{IN(0)}$	Logical "0" Input Current	$V_{IN} = 0V$	-5		$\mu A$
$C_{IN}$	$V_{IN}$ Input Capacitance		5		pF
<b>CAL, RESET Digital Input Characteristics</b>					
$V_{IN(1)}$	Logical "1" Input Voltage	$V^+ = 5.25V$		<b>3.5</b>	V(min)
$V_{IN(0)}$	Logical "0" Input Voltage	$V^+ = 4.75V$		<b>1.0</b>	V(max)
$I_{IN(1)}$	Logical "1" Input Current	$V_{IN} = 5.0V$	5		$\mu A$
$I_{IN(0)}$	Logical "0" Input Current	$V_{IN} = 0V$	-5		$\mu A$
$C_{IN}$	Input Capacitance		5		pF
<b>D00 - D13 Digital Output Characteristics</b>					
$V_{OUT(1)}$	Logical "1" Output Voltage	$V_D$ I/O = 4.75V, $I_{OUT} = -360 \mu A$		<b>4.5</b>	V(min)
$V_{OUT(1)}$	Logical "1" Output Voltage	$V_D$ I/O = 2.7V, $I_{OUT} = -360$ mA		<b>2.5</b>	V(min)
$V_{OUT(0)}$	Logical "0" Output Voltage	$V_D$ I/O = 5.25V, $I_{OUT} = 1.6$ mA		<b>0.4</b>	V(max)
		$V_D$ I/O = 3.3V, $I_{OUT} = 1.6$ mA		<b>0.4</b>	V(max)
$I_{OZ}$	TRI-STATE Output Current	$V_{OUT} = 3V$ or $5V$	100		nA
		$V_{OUT} = 0V$	-100		nA
$+I_{SC}$	Output Short Circuit Source Current	$V_{OUT} = 0V$ , $V_D$ I/O = 3V	-10		mA
$-I_{SC}$	Output Short Circuit Sink Current	$V_{OUT} = V_D$ I/O = 3V	12		mA
<b>Power Supply Characteristics</b>					
$I_A$	Analog Supply Current	$\overline{PD} = V_D$ I/O	70	<b>85</b>	mA(max)
$I_D$	Digital Supply Current	$\overline{PD} = V_D$ I/O	7	<b>8</b>	mA(max)
$I_D$ I/O	Output Bus Supply Current	$\overline{PD} = V_D$ I/O	1	<b>2</b>	mA(max)
	Total Power Consumption	$\overline{PD} = V_D$ I/O	390	<b>475</b>	mW(max)
		$\overline{PD} = DGND$	<2		mW
PSRR	Power Supply Rejection Ratio	250 mV <sub>PP</sub> 100kHz riding on $V_A$	54		dB

## AC Electrical Characteristics

The following specifications apply for AGND = DGND = DGND I/O = 0V,  $V^+ = V_A = V_D = +5.0V$ ,  $V_D$  I/O = 3.0V or 5.0V,  $\overline{PD} = +5V$ ,  $V_{REF+} = +2.0V$ ,  $V_{REF IN} = AGND$ ,  $f_{CLK} = 2.5$  MHz,  $R_S = 25\Omega$ ,  $C_L = 50$  pF/pin. After Auto-Cal @ Temperature. **Boldface limits apply for  $T_A = T_J = T_{MIN}$  to  $T_{MAX}$** ; all other limits  $T_A = T_J = 25^\circ C$  (Notes 7, 8, 9)

Symbol	Parameter	Conditions	Typical (Note 10)	Limits (Note 11)	Units (Limits)
$f_{CLK}$	Conversion Clock (CLOCK) Frequency		300		kHz(min)
			3	<b>2.5</b>	MHz(max)
	Conversion Clock Duty Cycle		45		<b>%(min)</b>
			55		<b>%(max)</b>
$t_{CONV}$	Conversion Latency		13		Clock Cycles
$t_{AD}$	Aperture Delay		9		ns

## AC Electrical Characteristics (Continued)

The following specifications apply for AGND = DGND = DGND I/O = 0V,  $V^+ = V_A = V_D = +5.0V$ ,  $V_D$  I/O = 3.0V or 5.0V,  $\overline{PD} = +5V$ ,  $V_{REF^+} = +2.0V$ ,  $V_{REF\ IN} = AGND$ ,  $f_{CLK} = 2.5\text{ MHz}$ ,  $R_S = 25\Omega$ ,  $C_L = 50\text{ pF/pin}$ . After Auto-Cal @ Temperature. **Boldface limits apply for  $T_A = T_J = T_{MIN}$  to  $T_{MAX}$ :** all other limits  $T_A = T_J = 25^\circ\text{C}$  (Notes 7, 8, 9)

Symbol	Parameter	Conditions	Typical (Note 10)	Limits (Note 11)	Units (Limits)
$t_{OD}$	Falling edge of CLK to Data Valid		50		ns
$t_{EOCL}$	Falling edge of CLK to falling edge of EOC		$1/(4f_{CLK})$	<b>90</b> <b>130</b>	ns(min) ns(max)
$t_{DATA\_VALID}$	Falling edge of CLOCK to Data Valid		$1/(8f_{CLK})$	<b>38</b> <b>95</b>	ns(min) ns(max)
$t_{ON}$	$\overline{RD}$ low to data valid on D00 -D13		23	<b>33</b>	ns(max)
$t_{OFF}$	$\overline{RD}$ high to D00 -D13 in TRI-STATE		25	<b>33</b>	ns(max)
$t_{CAL}$	Calibration Time		110		ms

**Note 1:** Absolute Maximum Ratings indicate limits beyond which damage to the device may occur. Operating Ratings indicate conditions for which the device is functional, but do not guarantee specific performance limits. For guaranteed specifications and test conditions, see the Electrical Characteristics. The guaranteed specifications apply only for the test conditions listed. Some performance characteristics may degrade when the device is not operated under the listed test conditions.

**Note 2:** All voltages are measured with respect to GND = AGND = DGND I/O = 0V, unless otherwise specified.

**Note 3:** When the input voltage at any pin exceeds the power supplies (that is,  $V_{IN} < AGND$  or  $V_{IN} > V_A$  or  $V_D$ ), the current at that pin should be limited to 25 mA. The 50 mA maximum package input current rating limits the number of pins that can safely exceed the power supplies with an input current of 25 mA to two.

**Note 4:** The absolute maximum junction temperature ( $T_{Jmax}$ ) for this device is  $150^\circ\text{C}$ . The maximum allowable power dissipation is dictated by  $T_{Jmax}$ , the junction-to-ambient thermal resistance ( $\theta_{JA}$ ), and the ambient temperature ( $T_A$ ), and can be calculated using the formula  $P_{DMAX} = (T_{Jmax} - T_A)/\theta_{JA}$ . In the 52-pin TQFP,  $\theta_{JA}$  is  $70^\circ\text{C/W}$ , so  $P_{DMAX} = 1,785\text{ mW}$  at  $25^\circ\text{C}$  and  $982\text{ mW}$  at the maximum operating ambient temperature of  $85^\circ\text{C}$ . Note that the power dissipation of this device under normal operation will typically be about  $410\text{ mW}$  ( $390\text{ mW}$  quiescent power +  $20\text{ mW}$  due to 1 TTL load on each digital output). The values for maximum power dissipation listed above will be reached only when the ADC14161 is operated in a severe fault condition (e.g. when input or output pins are driven beyond the power supply voltages, or the power supply polarity is reversed). Obviously, such conditions should always be avoided.

**Note 5:** Human body model is 100 pF capacitor discharged through a  $1.5k\Omega$  resistor. Machine model is 220 pF discharged through ZERO  $\Omega$ .

**Note 6:** See AN450, "Surface Mounting Methods and Their Effect on Product Reliability", or the section entitled "Surface Mount" found in any post 1986 National Semiconductor Linear Data Book, for other methods of soldering surface mount devices.

**Note 7:** The inputs are protected as shown below. Input voltage magnitudes up to 5V above  $V_A$  or 5V below GND will not damage this device, provided current is limited per Note 3. However, errors in the A/D conversion can occur if the input goes above  $V_A$  or below GND by more than 100 mV. As an example, if  $V_A$  is  $4.75V_{DC}$ , the full-scale input voltage must be  $\leq 4.85V_{DC}$  to ensure accurate conversions

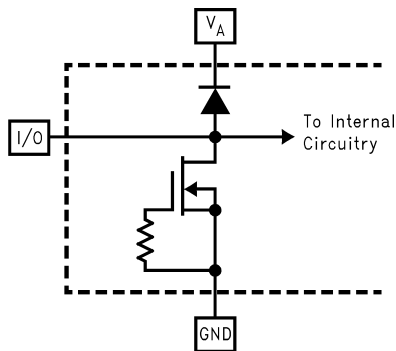

10015411

### ESD Protection Scheme for Digital Input pins

**Note 8:** To guarantee accuracy, it is required that  $V_A$  and  $V_D$  be connected together and to the same power supply with separate bypass capacitors at each  $V^+$  pin.

**Note 9:** With the test condition for  $V_{REF} = (V_{REF^+} - V_{REF^-})$  given as  $+2.0V$ , the 14-bit LSB is  $122\ \mu\text{V}$ .

**Note 10:** Typical figures are at  $T_A = T_J = 25^\circ\text{C}$ , and represent most likely parametric norms.

**Note 11:** Tested limits are guaranteed to Nations's AOQL (Average Outgoing Quality Level).

**Note 12:** Integral Non Linearity is defined as the deviation of the analog value, expressed in LSBs, from the straight line that passes through positive full-scale and negative full-scale.

**Note 13:** Timing specifications are tested at the TTL logic levels,  $V_{IL} = 0.4V$  for a falling edge and  $V_{IH} = 2.4V$  for a rising edge. TRI-STATE output voltage is forced to  $1.4V$ .

**Note 14:** Optimum SNR performance will be obtained by keeping the reference input in the  $1.8V$  to  $2.2V$  range. The LM4041CIM3-ADJ (SOT-23 package) or the LM4041CIZ-ADJ (TO-92 package), bandgap voltage reference is recommended for this application.

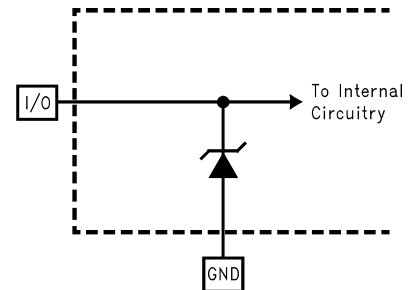

10015412

### ESD Protection Scheme for Analog Input and Digital Output pins



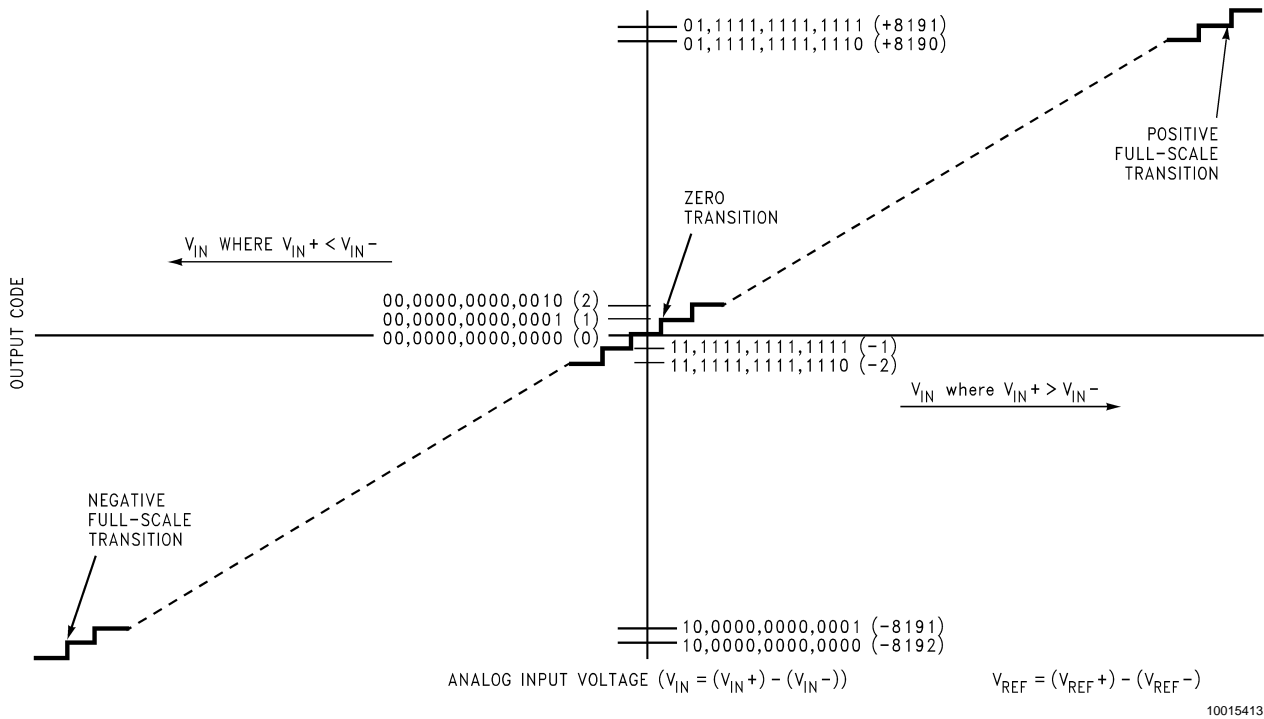

10015413

FIGURE 1. Transfer Characteristics

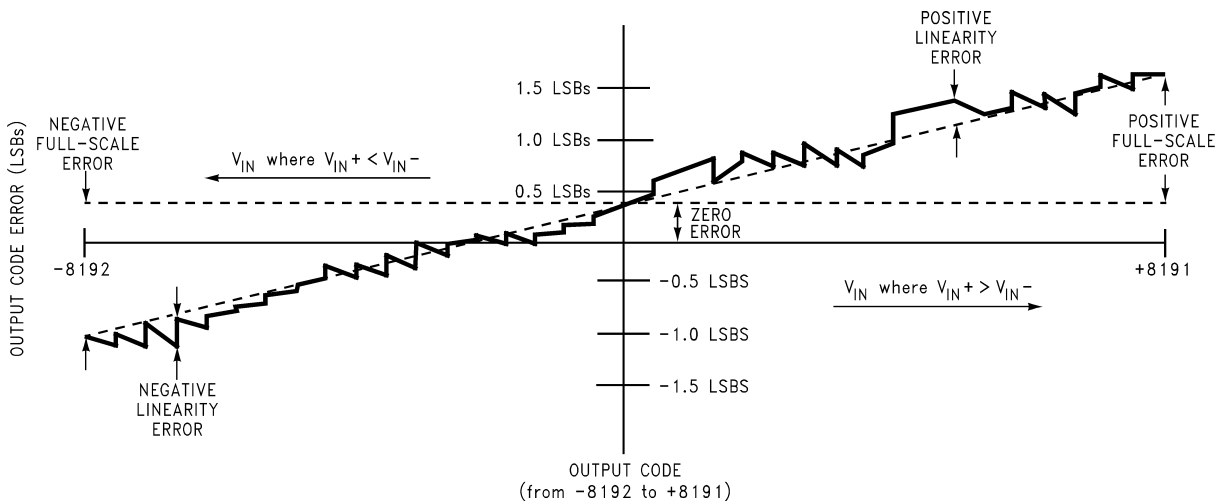

10015414

FIGURE 2. Simplified Error Curve vs. Output Code after Auto-Cal cycle

# Typical Performance Characteristics

**INL vs Temperature**

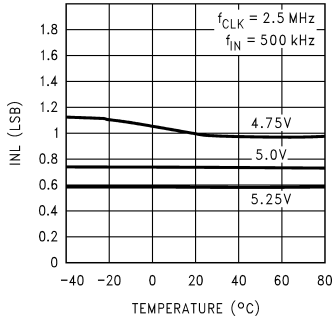

10015425

**DNL vs Temperature**

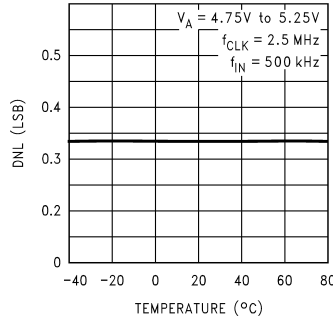

10015426

**SNR vs Temperature**

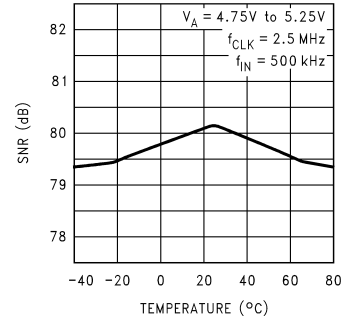

10015427

**INL vs V\_REF and Temperature**

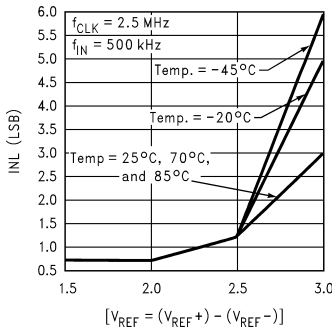

10015435

**DNL vs V\_REF and Temperature**

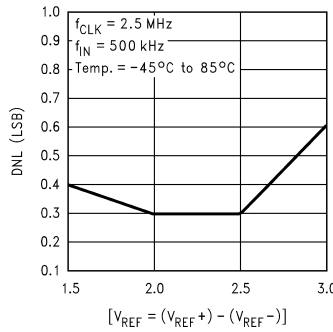

10015434

**THD vs Temperature**

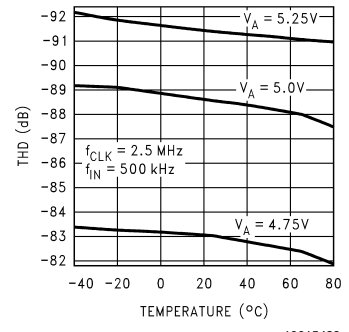

10015428

**SINAD & ENOB vs Temperature**

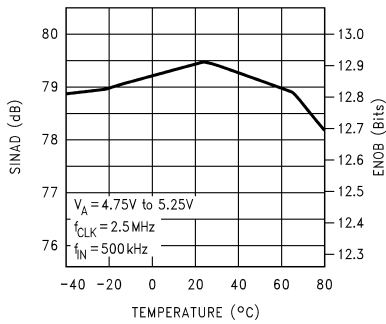

10015429

**SINAD & ENOB vs Clock Duty Cycle**

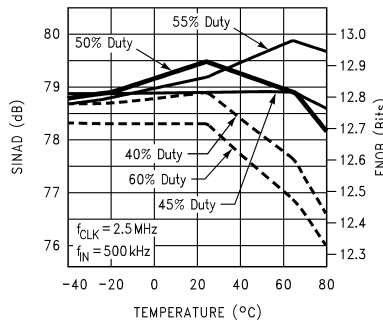

10015430

**SFDR vs Temperature and f\_IN**

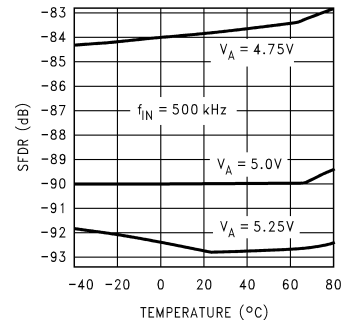

10015431

**IMD**

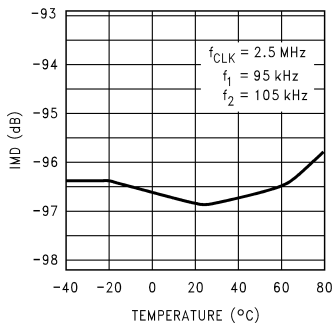

10015432

**Spectral Response**

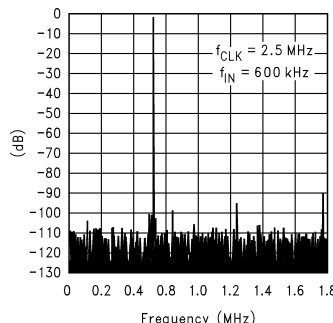

10015433

## Specification Definitions

**APERTURE JITTER** is the variation in aperture delay from sample to sample. Aperture jitter shows up as input noise.

**APERTURE DELAY** is the time required after the falling edge of the clock for the sampling switch to open. In other words, for the Track/Hold circuit to go from "track" mode into the "hold" mode. The Track/Hold circuit effectively stops capturing the input signal and goes into the "hold" mode  $t_{AD}$  after the fall of the clock.

**DIFFERENTIAL NON-LINEARITY (DNL)** is the measure of the maximum deviation from the ideal step size of 1 LSB.

**EFFECTIVE NUMBER OF BITS (ENOB, or EFFECTIVE BITS)** is another method of specifying Signal-to-Noise and Distortion Ratio, or SINAD. ENOB is defined as  $(\text{SINAD} - 1.76) / 6.02$ .

**FULL SCALE ERROR** is the difference between the input voltage  $[(V_{IN+}) - (V_{IN-})]$  just causing a transition to positive full scale and  $V_{REF} - 1.5 \text{ LSB}$ , where  $V_{REF}$  is  $(V_{REF+ IN}) - (V_{REF- IN})$ .

**FULL POWER BANDWIDTH** is a measure of the frequency at which the reconstructed output fundamental drops 3 dB below its low frequency value for a full scale input.

**INTERMODULATION DISTORTION (IMD)** is the creation of additional spectral components as a result of two sinusoidal frequencies being applied to the ADC input at the same time. It is defined as the ratio of the power in the intermodulation products to the total power in the original frequencies. IMD is usually expressed in dB.

**INTEGRAL NON-LINEARITY (INL)** is a measure of the deviation of each individual code from a line drawn from negative full scale ( $1/2$  LSB below the first code transition) through positive full scale (the last code transition). The deviation of any given code from this straight line is measured from the center of that code value.

**MISSING CODES** are those output codes that are skipped and will never appear at the ADC outputs. These codes can not be reached by any input value.

**OUTPUT DELAY** is the time delay after the falling edge of the input clock before the data update is present at the output pins.

**PIPELINE DELAY (LATENCY)** is the number of clock cycles between initiation of conversion and when that data is presented to the output stage. Data for any given sample is available the Pipeline Delay plus the Output Delay after that sample is taken. New data is available at every clock cycle, but the data lags the conversion by the pipeline delay.

**POWER SUPPLY REJECTION RATIO (PSRR)** is a measure of how well an a.c. signal riding upon the power supply is rejected at the output.

**SIGNAL TO NOISE RATIO (SNR)** is the ratio, expressed in dB, of the rms value of the input signal to the rms value of the sum of all other spectral components below one-half the sampling frequency, not including harmonics or dc.

**SIGNAL TO NOISE PLUS DISTORTION (S/(N+D) or SINAD)** is the ratio, expressed in dB, of the rms value of the input signal to the rms value of all of the other spectral components below half the clock frequency, including harmonics but excluding dc.

**SPURIOUS FREE DYNAMIC RANGE (SFDR)** is the difference, expressed in dB, between the rms values of the input signal and the peak spurious signal, where a spurious signal is any signal present in the output spectrum that is not present at the input.

**TOTAL HARMONIC DISTORTION (THD)** is the ratio, expressed in dB or dBc, of the rms total of the first six harmonic components, to the rms value of the input signal.

**ZERO ERROR** is the difference between the ideal differential input voltage ( $1/2$  LSB) and the actual input voltage that just causes a transition from an output code of 2047 to an output code of 2048.

# Timing Diagrams

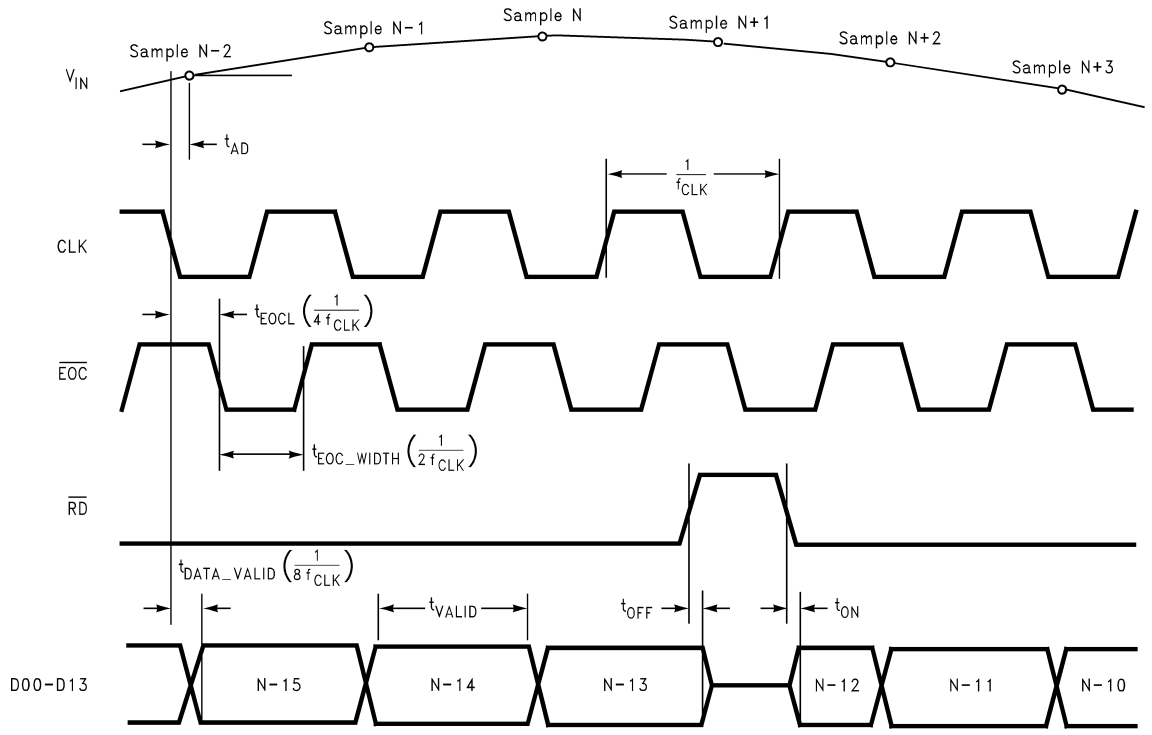

**TIMING DIAGRAM 1. Output Timing**

10015415

Minimum  $f_{CLK}$  is 300 kHz

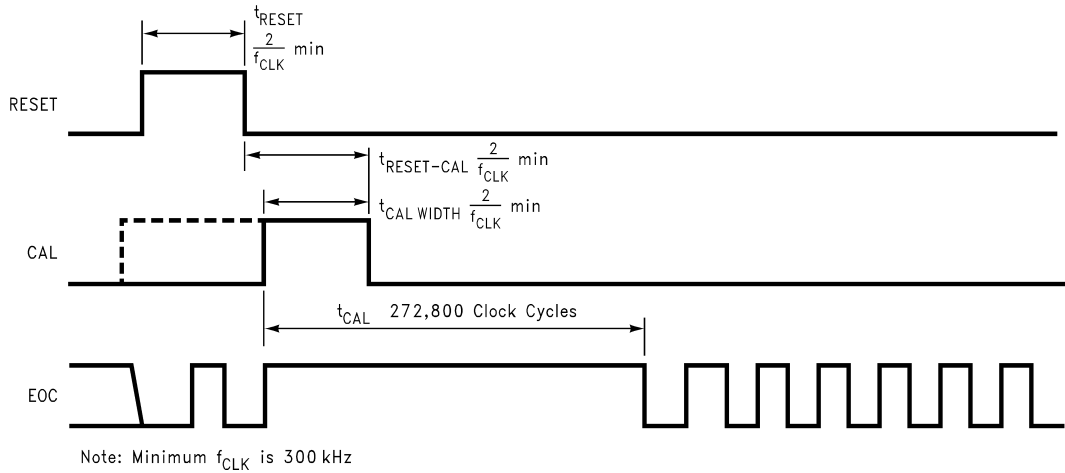

**TIMING DIAGRAM 2. Reset and Calibration**

10015416

## Functional Description

Operating on a single +5V supply, the ADC14161 uses a pipelined architecture and has error correction circuitry and a calibration mode to help ensure maximum performance at all times.

Balanced analog signals with a peak-to-peak voltage equal to the input reference voltage,  $V_{REF}$ , and centered around the common mode input voltage,  $V_{CM}$ , are digitized to 14 bits (13 bits plus sign). Neglecting offsets, positive input signal voltages ( $V_{IN+} - V_{IN-} > 0$ ) produce positive digital output data and negative input signal voltages ( $V_{IN+} - V_{IN-} < 0$ ) produce negative output data. The input signal can be digitized at any clock rate between 300 Ksps and 2.5 Msps.

Input voltages below the negative full scale value will cause the output word to take on the negative full scale value of 10,000,0000,0000. Input voltage above the positive full scale value will cause the output word to take on the positive full scale value of 01,1111,1111,1111.

The output word rate is the same as the clock frequency. The analog input voltage is acquired at the falling edge of the clock and the digital data for that sample is delayed by the pipeline for 13 clock cycles plus  $t_{DATA\_VALID}$ . The digital output is undefined if the chip is being reset or is in the calibration mode. The output signal may be inhibited by the  $\overline{RD}$  pin while the converter is in one of these modes.

The  $\overline{RD}$  pin must be low to enable the digital outputs. A logic low on the power down ( $\overline{PD}$ ) pin reduces the converter power consumption to less than two milliwatts.

## Applications Information

### 1.0 OPERATING CONDITIONS

We recommend that the following conditions be observed for operation of the ADC14161:

- $4.75V \leq V_A \leq 5.25V$
- $5.25V \leq V_D \leq 5.25V$
- $3.0V \leq V_D I/O \leq VD$
- $0.3MHz \leq f_{CLK} \leq 2.5 MHz$
- $V_{CM} = 2.0V$  (forced)
- $V_{REF IN+} = 2.0V$
- $V_{REF IN-} = AGND$

### 1.1 The Analog Inputs

The ADC14161 has two analog signal inputs,  $V_{IN+}$  and  $V_{IN-}$ . These two pins form a balanced signal input. There are two reference pins,  $V_{REF+ IN}$  and  $V_{REF- IN}$ . These pins form a differential input reference.

### 1.2 Reference Inputs

$V_{REF+ IN}$  should always be more positive than  $V_{REF- IN}$ . The effective reference voltage,  $V_{REF}$ , is the difference between these two voltages:

$$V_{REF} = (V_{REF+ IN}) - (V_{REF- IN}).$$

The operational voltage range of  $V_{REF+ IN}$  is +1.8 Volts to +3.0 Volts. The operational voltage range of  $V_{REF- IN}$  is ground to 1.0V. For best performance, the difference between  $V_{REF+ IN}$  and  $V_{REF- IN}$  should remain within the range of 1.8V to 2.2V. Reducing the reference voltage below 1.8V will decrease the signal-to-noise ratio (SNR) of the ADC14161. Increasing the reference voltage (and, consequently, the input signal swing) above 2.2V will increase THD.

$V_{REF (MID)}$  is the reference mid-point and is derived from  $V_{CM}$ . This point is brought out only to be bypassed. By pass this pin with 0.1 $\mu$ F capacitor to ground. Do not load this pin.

It is very important that all grounds associated with the reference voltage make connection to the analog ground plane at a single point to minimize the effects of noise currents in the ground path.

### 1.3 Signal Inputs

The signal inputs are  $V_{IN+}$  and  $V_{IN-}$ . The signal input,  $V_{IN}$ , is defined as

$$V_{IN} = (V_{IN+}) - (V_{IN-}).$$

Figure 3 indicates the relationship between the input voltage and the reference voltages. Figure 4 shows the expected input signal range.

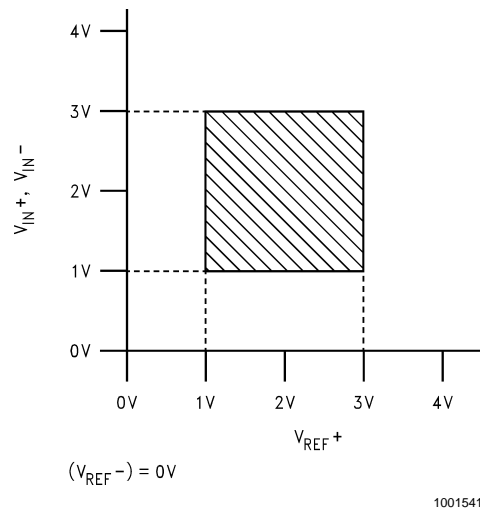

10015417

FIGURE 3. Typical Input to Reference Relationship.

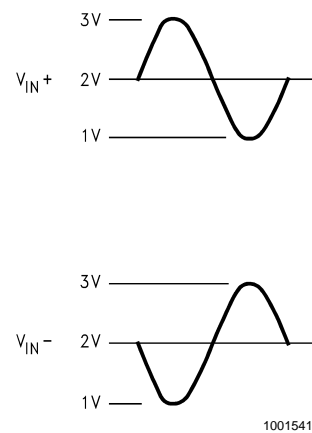

10015418

FIGURE 4. Expected Input Signal Range.

The ADC14161 performs best with a balanced input centered around  $V_{CM}$ . The peak-to-peak voltage swing at either  $V_{IN+}$  or  $V_{IN-}$  should be less than the reference voltage and each signal input pin should be centered on the  $V_{CM}$  voltage. The two  $V_{CM}$ -centered input signals should be exactly 180° out of phase from each other. As a simple check to ensure this, be certain that the average voltage at the ADC input pins is equal to  $V_{CM}$ . Drive the analog inputs with a source impedance less than 100 Ohms.

## Applications Information (Continued)

The sign bit of the output word will be a logic low when  $V_{IN+}$  is greater than  $V_{IN-}$ . When  $V_{IN+}$  is less than  $V_{IN-}$ , the sign bit of the output word will be a logic high.

For single ended operation, one of the analog inputs should be connected to  $V_{CM}$ . However, SNR and SINAD are reduced by about 12dB with a single ended input as compared with differential inputs.

An input voltage of  $V_{IN} = (V_{IN+}) - (V_{IN-}) = 0$  will be interpreted as mid-scale and will thus be converted to 00,0000,0000,0000, plus any offset error.

The  $V_{IN+}$  and the  $V_{IN-}$  inputs of the ADC14161 consist of an analog switch followed by a switched-capacitor amplifier. The capacitance seen at the analog input pins changes with the clock level, appearing as 12 pF when the clock is low, and 28 pF when the clock is high. It is recommended that the ADC14161 be driven with a low impedance source of 100 Ohms or less.

A simple application circuit is shown in *Figure 6* and *Figure 7*. Here we use two LM6172 dual amplifiers to provide a balanced input to the ADC14161. Note that better noise performance is achieved when  $V_{REF+ IN}$  voltage is forced with a well-bypassed resistive divider. The resulting offset and offset drift is minimal.

Since a dynamic capacitance is more difficult to drive than is a fixed capacitance, choose driving amplifiers carefully. The CLC427, CLC440, LM6152, LM6154, LM6172, LM6181 and LM6182 are excellent amplifiers for driving the ADC14161.

### 1.4 $V_{CM}$ Analog Inputs

The  $V_{CM}$  input of the ADC14161 is internally biased to 40% of the  $V_A$  supply with on-chip resistors, as shown in *Figure 5*. The  $V_{CM}$  pin must be bypassed to prevent any power supply noise from modulating this voltage. Modulation of the  $V_{CM}$  potential will result in the introduction of noise into the input signal. The advantage of simply bypassing  $V_{CM}$  (without driving it) is the circuit simplicity. On the other hand, if the  $V_A$  supply can vary for any reason,  $V_{CM}$  will also vary at a rate and amplitude related to the RC filter created by the bypass capacitor and the internal divider resistors. However, performance of this approach will be adequate for many applications.

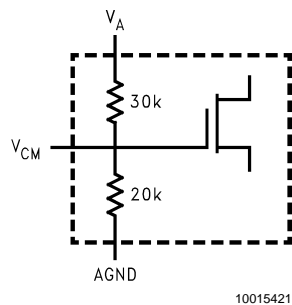

**FIGURE 5.  $V_{CM}$  input to the ADC14161  $V_{CM}$  is set to 40% of  $V_A$  with on-chip resistors. Performance is improved when  $V_{CM}$  is driven with a stable, low impedance source**

By forcing  $V_{CM}$  to a fixed potential, you can avoid the problems mentioned above. One such approach is to buffer the 2.0 Volt reference voltage to drive the  $V_{CM}$  input, holding it at a constant potential as shown in *Figure 6* and *Figure 8*. If the

reference voltage is different from the desired  $V_{CM}$ , that desired  $V_{CM}$  voltage may be derived from the reference or from another stable source.

Note that the buffer used for this purpose should be a slow, low noise amplifier. The LMC660, LMC662, LMC272 and LMC7101 are good choices for driving the  $V_{CM}$  pin of the ADC14161.

If it is desired to use a multiplexer at the analog input, that multiplexer should be switched at the rising edge of the clock signal.

### 2.0 DIGITAL INPUTS

Digital Inputs consist of CLOCK, RESET, CAL,  $\overline{RD}$  and  $\overline{PD}$ . All digital input pins should remain stable from the fall of the clock until 30ns after the fall of the clock to minimize digital noise corruption of the input signal on the die.

**2.1 The CLOCK** signal drives an internal phase delay loop to create timing for the ADC. Drive the clock input with a stable, low phase jitter clock signal in the range of 300 kHz to 2.5 MHz. The trace carrying the clock signal should be as short as possible. This trace should not cross any other signal line, analog or digital, not even at 90°.

The CLOCK signal also drives the internal state machine. If the clock is interrupted, the data within the pipeline could become corrupted.

A 100 Ohm damping resistor should be placed in series with the CLOCK pin to prevent signal undershoot at that input.

**2.2 The RESET** input is level sensitive and must be pulsed high for at least two clock cycles to reset the ADC after power-up and before calibration (See Timing Diagram 2).

**2.3 The CAL** input is level sensitive and must be pulsed high for at least two clock cycles to begin ADC calibration (See Timing Diagram 2). Reset the ADC14161 before calibrating. Re-calibrate after the temperature has changed by more than 50°C since the last calibration was performed and after return from power down.

During calibration, use the same clock frequency that will be used for conversions to avoid excessive offset errors.

Calibration takes 272,800 clock cycles. Irrelevant data may appear at the data outputs during RESET or CAL and for 13 clock cycles thereafter. Calibration should not be started until the reference outputs have settled (100mS with 1 $\mu$ F capacitors on these outputs) after power up or coming out of the power down mode.

**2.4  $\overline{RD}$**  pin is used to READ the conversion data. When the  $\overline{RD}$  pin is low, the output buffers go into the active state. When the  $\overline{RD}$  input is high, the output buffers are in the high impedance state.

**2.5 The  $\overline{PD}$**  pin, when low, holds the ADC14161 in a power-down mode where power consumption is typically less than 2mW to conserve power when the converter is not being used. The ADC14161 will begin normal operation within  $t_{WU}$  after this pin is brought high, provided a valid CLOCK input is present. Power dissipation during shut-down is not affected by the clock frequency, or by whether there is a clock signal present. The data in the pipeline is corrupted while in the power down mode. The ADC14161 should be reset and calibrated upon returning to normal operation after a power down.

### 3.0 OUTPUTS

The ADC14161 has four analog outputs:  $V_{REF+ OUT}$ ,  $V_{REF- OUT}$ ,  $V_{REF (MID)}$  and  $V_{CM}$ . There are 15 digital outputs: EOC (End of Conversion) and 14 Data Output pins.



Applications Information (Continued)

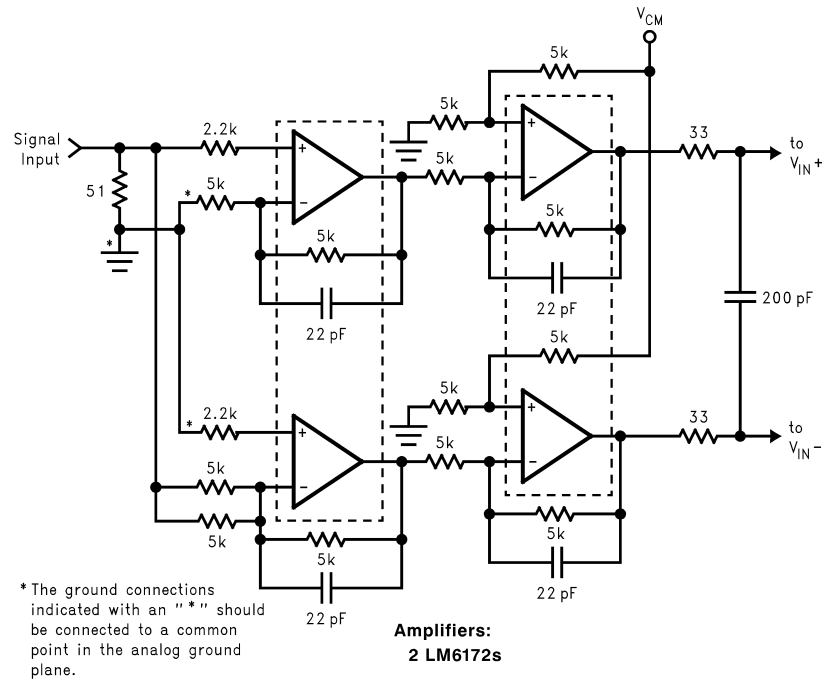

10015420

FIGURE 7. Differential drive circuit of Figure 6. All 5k resistors are 0.1%. Tolerance of the other resistors is not critical.

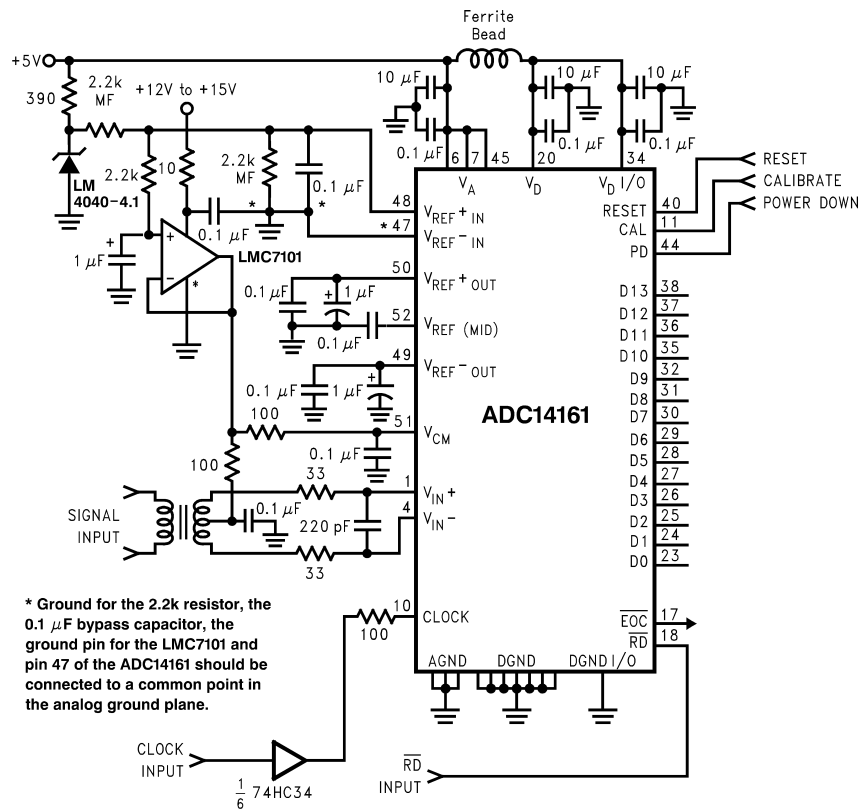

10015422

FIGURE 8. Driving the signal inputs with a transformer.



## Applications Information (Continued)

### 5.0 LAYOUT AND GROUNDING

Proper grounding and proper routing of all signals are essential to ensure accurate conversion. Separate analog and digital ground planes that are connected beneath the ADC14161 are required to achieve specified performance.

The analog and digital grounds may be in the same layer, but should be separated from each other and should never overlap each other. Separation should be at least  $\frac{1}{8}$  inch, where possible.

The ground return for the digital supply (DGND I/O ) carries the ground current for the output drivers. This output current can exhibit high transients that could add noise to the conversion process. To prevent this from happening, the DGND I/O pin should **NOT** be connected in close proximity to any of the ADC14161's ground pins.

Capacitive coupling between the typically noisy digital ground plane and the sensitive analog circuitry can lead to poor performance that may seem impossible to isolate and remedy. The solution is to keep the analog circuitry separated from the digital circuitry and from the digital ground plane.

Digital circuits create substantial supply and ground current transients. The logic noise thus generated could have significant impact upon system noise performance. The best logic family to use in systems with A/D converters is one which employs non-saturating transistor designs, or has low noise characteristics, such as the 74LS, 74HC(T) and 74AC(T)Q families. The worst noise generators are logic families that draw the largest supply current transients during clock or signal edges, like the 74F and the 74AC(T) families.

Since digital switching transients are composed largely of high frequency components, total ground plane copper weight will have little effect upon the logic-generated noise. This is because of the skin effect. Total surface area is more important than is total ground plane volume.

An effective way to control ground noise is by connecting the analog and digital ground planes together beneath the ADC with a copper trace that is very narrow compared with the

rest of the ground plane. A typical width is  $\frac{3}{16}$  inch (4 to 5 mm). This narrowing beneath the converter provides a fairly high impedance to the high frequency components of the digital switching currents, directing them away from the analog pins. The relatively lower frequency analog ground currents see a relatively low impedance across this narrow ground connection.

Generally, analog and digital lines should cross each other at 90 degrees to avoid getting digital noise into the analog path. To maximize accuracy in high speed, high resolution systems, however, avoid crossing analog and digital lines altogether. It is important to keep any clock lines isolated from ALL other lines, including other digital lines. Even the generally accepted 90 degree crossing should be avoided as even a little coupling can cause problems at high frequencies. This is because other lines can introduce phase noise (jitter) into the clock line, which can lead to degradation of SNR.

Best performance at high frequencies and at high resolution is obtained with a straight signal path. That is, the signal path through all components should form a straight line wherever possible.

Be especially careful with the layout of inductors. Mutual inductance can change the characteristics of the circuit in which they are used. Inductors should not be placed side by side, even with just a small part of their bodies beside each other.

The analog input should be isolated from noisy signal traces to avoid coupling of spurious signals into the input. Any external component (e.g., a filter capacitor) connected between the converter's input and ground should be connected to a very clean point in the analog ground plane.

*Figure 9* gives an example of a suitable layout. All analog circuitry (input amplifiers, filters, reference components, etc.) should be placed on or over the analog ground plane. All digital circuitry and I/O lines should be placed over the digital ground plane.

All ground connections should have a low inductance path to ground.

Applications Information (Continued)

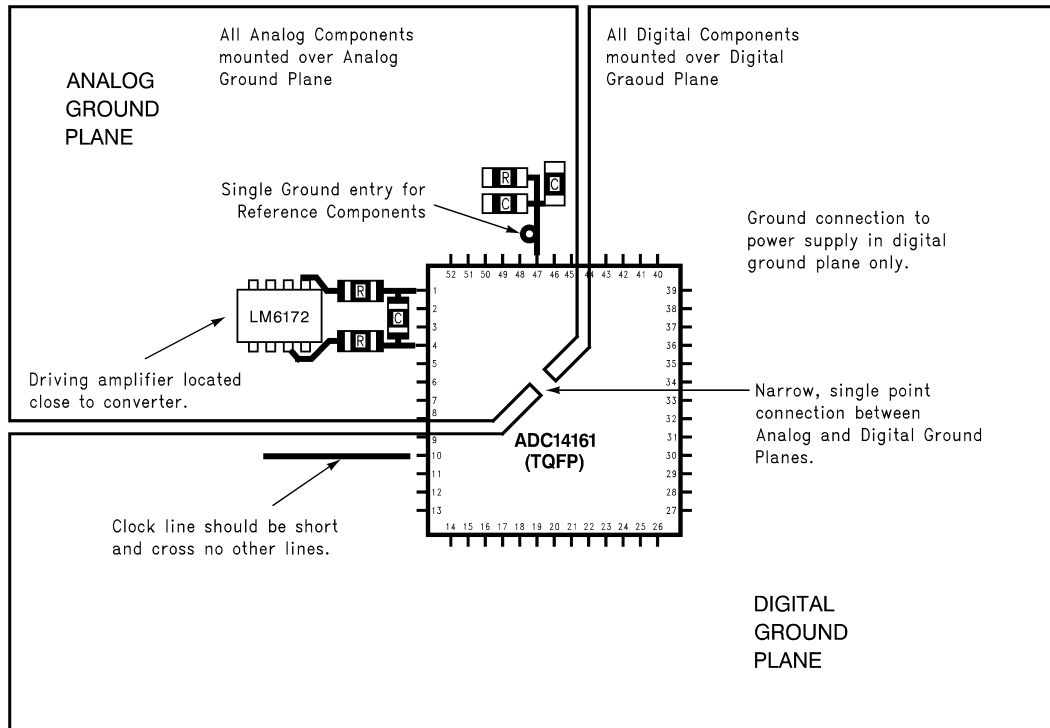

10015423

FIGURE 9. Example at a suitable layout.

6.0 DYNAMIC PERFORMANCE

The ADC14161 can achieve impressive dynamic performance. To achieve the best dynamic performance with the ADC14161, the clock source driving the CLK input must be free of jitter. For best ac performance, isolate the ADC clock from any digital circuitry with buffers, as with the clock tree shown in *Figure 10*.

As mentioned in section 5.0, it is good practice to keep the ADC clock line as short as possible and to keep it well away from any other signals. Other signals can introduce phase noise (jitter) into the clock signal, which can lead to increased distortion. Even lines with 90° crossings have capacitive coupling, so try to avoid even these 90° crossings of the clock line.

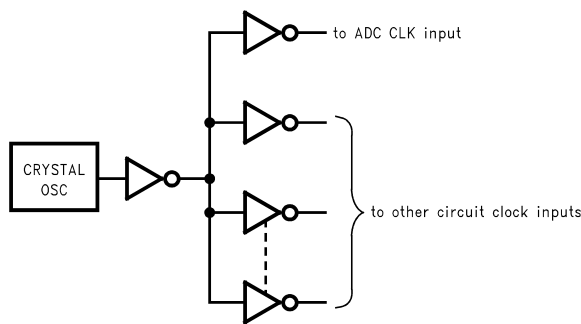

10015424

FIGURE 10. Isolating the ADC clock from other circuitry with a clock tree.

7.0 COMMON APPLICATION PITFALLS

**Driving the inputs (analog or digital) beyond the power supply rails.** For proper operation, all inputs should not go more than 100 mV beyond the supply rails (more than 100 mV below the ground pins or 100 mV above the supply pins). Exceeding these limits on even a transient basis may cause faulty or erratic operation. It is not uncommon for high speed digital circuits (e.g., 74F and 74AC devices) to exhibit undershoot that goes more than a volt below ground. A resistor of about 50 to 100Ω in series with the offending digital input will eliminate the problem.

Do not allow input voltages to exceed the supply voltage during power up.

Be careful not to overdrive the inputs of the ADC14161 with a device that is powered from supplies outside the range of the ADC14161 supply. Such practice may lead to conversion inaccuracies and even to device damage.

**Attempting to drive a high capacitance digital data bus.** The more capacitance the output drivers must charge for each conversion, the more instantaneous digital current flows through V<sub>D</sub> I/O and DGND I/O. These large charging current spikes can couple into the analog circuitry of the ADC14161, degrading dynamic performance. Adequate bypassing and maintaining separate analog and digital ground planes will reduce this problem. The digital data outputs should be buffered (with 74ACQ541, for example). Dynamic performance can also be improved by adding series resistors at each digital output, close to the ADC14161, which reduces the energy coupled back into the converter output pins by limiting the output current. A reasonable value for these resistors is 47Ω.

## Applications Information (Continued)

### Using an inadequate amplifier to drive the analog input.

As explained in Section 1.2, the capacitance seen at the input alternates between 12 pF and 28 pF, depending upon the phase of the clock. This dynamic load is more difficult to drive than is a fixed capacitance.

If the amplifier exhibits overshoot, ringing, or any evidence of instability, even at a very low level, it will degrade performance. Amplifiers that have been used successfully to drive the analog inputs of the ADC14161 include the CLC427, CLC440, LM6152, LM6154, LM6181 and the LM6182. A small series resistor at each amplifier output and a capacitor across the analog inputs (as shown in *Figure 7*) will often improve performance.

**Operating with the reference pins outside of the specified range.** As mentioned in section 1.1,  $V_{REF}$  should be in the range of

$$1.8V \leq V_{REF} \leq 2.2V$$

with  $V_{REF- IN} \leq 1.0V$ . Operating outside of these limits could lead to signal distortion.

**Using a clock source with excessive jitter, using excessively long clock signal trace, or having other signals coupled to the clock signal trace.** This will cause the sampling interval to vary, causing excessive output noise and a reduction in SNR performance.

**Connecting pins marked "NC" to any potential.** Some of these pins are used for factory testing. They should all be left floating. Connecting them to ground, power supply, or some other voltage could result in a non-functional device.

**Physical Dimensions** inches (millimeters)  
unless otherwise noted

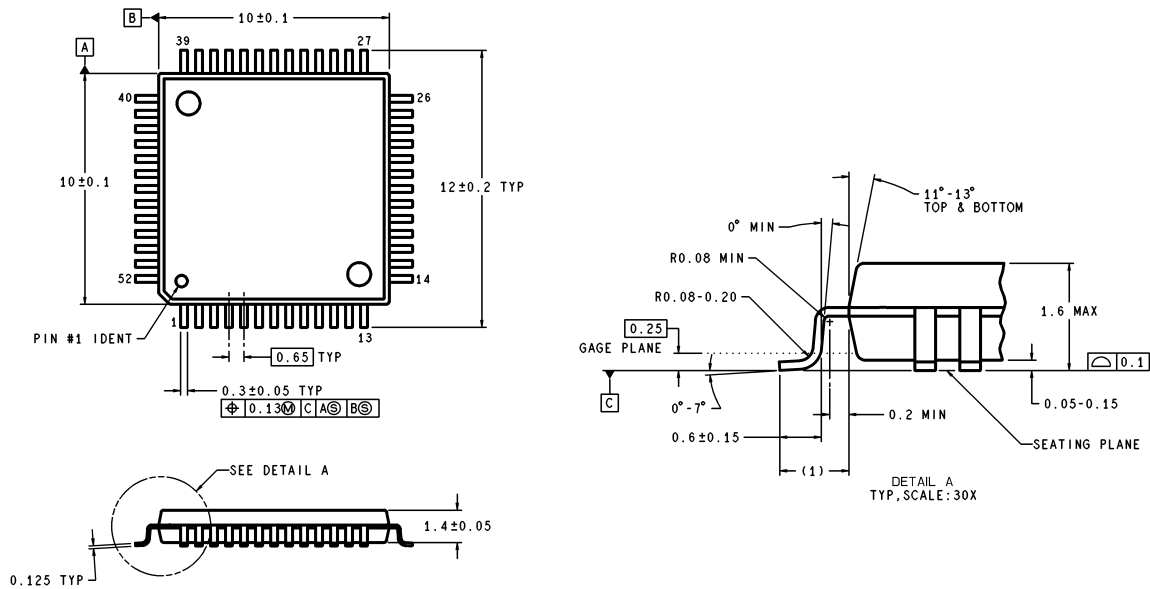

DIMENSIONS ARE IN MILLIMETERS

VEG52A (Rev B)

**52-Lead Thin Quad Flat Pack  
Ordering Information Package ADC14161CIVT  
NS Package Number VEG52A**

**LIFE SUPPORT POLICY**

NATIONAL'S PRODUCTS ARE NOT AUTHORIZED FOR USE AS CRITICAL COMPONENTS IN LIFE SUPPORT DEVICES OR SYSTEMS WITHOUT THE EXPRESS WRITTEN APPROVAL OF THE PRESIDENT AND GENERAL COUNSEL OF NATIONAL SEMICONDUCTOR CORPORATION. As used herein:

1. Life support devices or systems are devices or systems which, (a) are intended for surgical implant into the body, or (b) support or sustain life, and whose failure to perform when properly used in accordance with instructions for use provided in the labeling, can be reasonably expected to result in a significant injury to the user.
2. A critical component is any component of a life support device or system whose failure to perform can be reasonably expected to cause the failure of the life support device or system, or to affect its safety or effectiveness.



**National Semiconductor Corporation**  
Americas  
Email: support@nsc.com

www.national.com

**National Semiconductor Europe**  
Fax: +49 (0) 180-530 85 86  
Email: europe.support@nsc.com  
Deutsch Tel: +49 (0) 69 9508 6208  
English Tel: +44 (0) 870 24 0 2171  
Français Tel: +33 (0) 1 41 91 8790

**National Semiconductor Asia Pacific Customer Response Group**  
Tel: 65-2544466  
Fax: 65-2504466  
Email: ap.support@nsc.com

**National Semiconductor Japan Ltd.**  
Tel: 81-3-5639-7560  
Fax: 81-3-5639-7507