

NMC27C256BN



PRELIMINARY

T-46-13-25

# NMC27C256BN

## High Speed Version 262,144-Bit (32k x 8)

### One-Time Programmable CMOS PROM

#### General Description

The NMC27C256BN is a high-speed 256k one-time programmable CMOS PROM, ideally suited for applications where fast turnaround and low power consumption are important requirements.

The NMC27C256BN is designed to operate with a single +5V power supply with  $\pm 5\%$  or  $\pm 10\%$  tolerance.

The NMC27C256BN is packaged in a 28-pin dual-in-line plastic molded package without a transparent lid. This part is ideally suited for high volume production applications where cost is an important factor and programming only needs to be done once. Also the plastic molded package works well in auto insertion equipment used in automated assembly lines.

This EPROM is fabricated with National's proprietary, time proven CMOS double-poly silicon gate technology which combines high performance and high density with low power consumption and excellent reliability.

#### Features

- Clocked sense amps for fast access time down to 150 ns
- Low CMOS power consumption
  - Active power: 110 mW max
  - Standby power: 0.55 mW max
- Pin compatible with NMOS 256k EPROMs
- Fast and reliable programming—100  $\mu$ s typical/byte
- Static operation—no clocks required
- TTL, CMOS compatible inputs/outputs
- TRI-STATE<sup>®</sup> output
- Optimum EPROM for total CMOS systems
- Manufacturer's identification code for automatic programming control
- High current CMOS level output drivers

#### Block Diagram

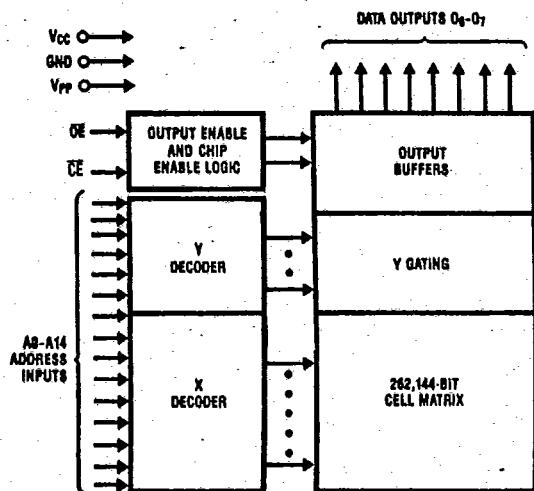

TL/D/8691-1

Pin Names

Pin Name	Description
A0-A14	Addresses
CE	Chip Enable
OE	Output Enable
O0-O7	Outputs
PGM	Program
NC	No Connect

NMC27C256BN

**Connection Diagram**

T-46-13-25

27C512 27512	27C128 27128	27C64 2764	27C32 2732	27C16 2716
A15	V <sub>PP</sub>	V <sub>PP</sub>		
A12	A12	A12		
A7	A7	A7	A7	A7
A6	A6	A6	A6	A6
A5	A5	A5	A5	A5
A4	A4	A4	A4	A4
A3	A3	A3	A3	A3
A2	A2	A2	A2	A2
A1	A1	A1	A1	A1
A0	A0	A0	A0	A0
O <sub>0</sub>	O <sub>0</sub>	O <sub>0</sub>	O <sub>0</sub>	O <sub>0</sub>
O <sub>1</sub>	O <sub>1</sub>	O <sub>1</sub>	O <sub>1</sub>	O <sub>1</sub>
O <sub>2</sub>	O <sub>2</sub>	O <sub>2</sub>	O <sub>2</sub>	O <sub>2</sub>
GND	GND	GND	GND	GND

**NMC27C256BN**  
Dual-In-Line Package

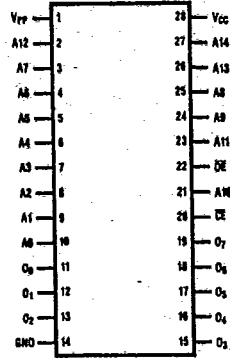

27C16 2716	27C32 2732	27C64 2764	27C128 27128	27C512 27512
V <sub>CC</sub>	V <sub>CC</sub>	V <sub>CC</sub>	V <sub>CC</sub>	V <sub>CC</sub>
A8	A8	NC	PGM	PGM
A9	A9	A8	A13	A13
V <sub>PP</sub>	A11	A9	A8	A8
OE	OE/V <sub>PP</sub>	A11	A9	A9
A10	A10	OE	A11	A11
OE/PGM	OE	A10	OE	OE/V <sub>PP</sub>
O <sub>7</sub>	O <sub>7</sub>	A10	A10	A10
O <sub>6</sub>	O <sub>6</sub>	OE	OE	OE
O <sub>5</sub>	O <sub>5</sub>	O <sub>7</sub>	O <sub>7</sub>	O <sub>7</sub>
O <sub>4</sub>	O <sub>4</sub>	O <sub>6</sub>	O <sub>6</sub>	O <sub>6</sub>
O <sub>3</sub>	O <sub>3</sub>	O <sub>5</sub>	O <sub>5</sub>	O <sub>5</sub>
		O <sub>4</sub>	O <sub>4</sub>	O <sub>4</sub>
		O <sub>3</sub>	O <sub>3</sub>	O <sub>3</sub>

TL/D/9691-2

Note: Socket compatible EPROM pin configurations are shown in the blocks adjacent to the NMC27C256BN pins.

Order Number NMC27C256BN  
See NS Package Number N28B

Commercial Temp Range (0°C to +70°C)  
V<sub>CC</sub> = 5V ± 5%

Parameter/Order Number	Access Time (ns)
NMC27C256BN15	150
NMC27C256BN20	200
NMC27C256BN25	250

Commercial Temp Range (0°C to +70°C)  
V<sub>CC</sub> = 5V ± 10%

Parameter/Order Number	Access Time (ns)
NMC27C256BN150	150
NMC27C256BN200	200
NMC27C256BN250	250

Note: For non-commercial temperature range parts, call factory.

Extended Temp. Range (-40°C to +85°C)  
V<sub>CC</sub> = 5V ± 5%

Parameter/Order Number	Access Time (ns)
NMC27C256BNE15	150
NMC27C256BNE20	200
NMC27C256BNE25	250

Extended Temp Range (-40°C to +85°C)  
V<sub>CC</sub> = 5V ± 10%

Parameter/Order Number	Access Time (ns)
NMC27C256BNE150	150
NMC27C256BNE200	200
NMC27C256BNE250	250

NMC27C256BN

### Absolute Maximum Ratings (Note 1)

Temperature Under Bias	-10°C to +80°C
Storage Temperature	-65°C to +150°C
All Input Voltages except A9 with Respect to Ground (Note 10)	+6.5V to -0.6V
All Output Voltages with Respect to Ground (Note 10)	V <sub>CC</sub> + 1.0V to GND - 0.6V
V <sub>PP</sub> Supply Voltage and A9 with Respect to Ground	+14.0V to -0.6V
Power Dissipation	1.0W

T-46-13-25

V <sub>CC</sub> Supply Voltage with Respect to Ground	+7.0V to -0.6V
Lead Temperature (Soldering, 10 sec.)	300°C
ESD Rating (Mil Spec 883C, Method 3015.2)	2000V

### Operating Conditions (Note 6)

Temperature Range	0°C to +70°C
V <sub>CC</sub> Power Supply	
NMC27C256BN15, 20, 25	+5V ±5%
NMC27C256BN150, 200, 250	+5V ±10%

## READ OPERATION

### DC Electrical Characteristics

Symbol	Parameter	Conditions	Min	Typ	Max	Units
I <sub>LI</sub>	Input Load Current	V <sub>IN</sub> = V <sub>CC</sub> or GND			1	μA
I <sub>LO</sub>	Output Leakage Current	V <sub>OUT</sub> = V <sub>CC</sub> or GND, $\overline{CE} = V_{IH}$			1	μA
I <sub>CC1</sub> (Note 8)	V <sub>CC</sub> Current (Active) TTL Inputs	$\overline{CE} = V_{IL}$ , f = 5 MHz Inputs = V <sub>IH</sub> or V <sub>IL</sub> , I/O = 0 mA		15	30	mA
I <sub>CC2</sub> (Note 9)	V <sub>CC</sub> Current (Active) CMOS Inputs	$\overline{CE} = GND$ , f = 5 MHz Inputs = V <sub>CC</sub> or GND, I/O = 0 mA		10	20	mA
I <sub>CCSB1</sub>	V <sub>CC</sub> Current (Standby) TTL Inputs	$\overline{CE} = V_{IH}$		0.1	1	mA
I <sub>CCSB2</sub>	V <sub>CC</sub> Current (Standby) CMOS Inputs	$\overline{CE} = V_{CC}$		0.5	100	μA
I <sub>PP</sub>	V <sub>PP</sub> Load Current	V <sub>PP</sub> = V <sub>CC</sub>			10	μA
V <sub>IL</sub>	Input Low Voltage		-0.2		0.8	V
V <sub>IH</sub>	Input High Voltage		2.0		V <sub>CC</sub> + 1	V
V <sub>OL1</sub>	Output Low Voltage	I <sub>OL</sub> = 2.1 mA			0.40	V
V <sub>OH1</sub>	Output High Voltage	I <sub>OH</sub> = -2.5 mA	3.5			V
V <sub>OL2</sub>	Output Low Voltage	I <sub>OL</sub> = 10 μA			0.1	V
V <sub>OH2</sub>	Output High Voltage	I <sub>OH</sub> = -10 μA	V <sub>CC</sub> - 0.1			V

### AC Electrical Characteristics

Symbol	Parameter	Conditions	NMC27C256B						Units
			N15, N150		N20, N200		N25, N250		
			Min	Max	Min	Max	Min	Max	
t <sub>ACC</sub>	Address to Output Delay	$\overline{CE} = \overline{OE} = V_{IL}$		150		200		250	ns
t <sub>CE</sub>	$\overline{CE}$ to Output Delay	$\overline{OE} = V_{IL}$		150		200		250	ns
t <sub>OE</sub>	$\overline{OE}$ to Output Delay	$\overline{CE} = V_{IL}$		60		75		100	ns
t <sub>DF</sub>	$\overline{OE}$ High to Output Float	$\overline{CE} = V_{IL}$	0	50	0	55	0	60	ns
t <sub>CF</sub>	$\overline{CE}$ High to Output Float	$\overline{OE} = V_{IL}$	0	50	0	55	0	60	ns
t <sub>OH</sub>	Output Hold from Addresses, $\overline{CE}$ or $\overline{OE}$ , Whichever Occurred First	$\overline{CE} = \overline{OE} = V_{IL}$	0		0		0		ns

**EXTENDED TEMPERATURE RANGE**

**Absolute Maximum Ratings** (Note 1)

Temperature Under Bias	Operating Temp. Range	-65°C to +150°C
Storage Temperature		
V <sub>CC</sub> Supply Voltages with Respect to Ground		+7.0V to -0.6V
All Input Voltages except A9 with Respect to Ground (Note 10)		+6.5V to -0.6V
All Output Voltages with Respect to Ground (Note 10)	V <sub>CC</sub> +1.0V to GND	-0.6V
V <sub>PP</sub> Supply Voltage and A9 with Respect to Ground		+14.0V to -0.6V
Power Dissipation		1.0W

Lead Temperature (Soldering, 10 sec.)	300°C
ESD Rating (Mil Spec 883C, Method 3015.2)	2000V

**Operating Conditions** (Note 6)

Temperature Range	-40°C to +85°C
V <sub>CC</sub> Power Supply	
NMC27C256BNE15, 20, 25	+5V ±5%
NMC27C256BNE150, 200, 250	+5V ±10%

**READ OPERATION**

**DC Electrical Characteristics**

Symbol	Parameter	Conditions	Min	Typ	Max	Units
I <sub>LI</sub>	Input Load Current	V <sub>IN</sub> = V <sub>CC</sub> or GND			10	μA
I <sub>LO</sub>	Output Leakage Current	V <sub>OUT</sub> = V <sub>CC</sub> or GND, $\overline{CE} = V_{IH}$			10	μA
I <sub>CC1</sub> (Note 9)	V <sub>CC</sub> Current (Active) TTL Inputs	$\overline{CE} = V_{IL}$ , f = 5 MHz All Inputs = V <sub>IH</sub> or V <sub>IL</sub> , I/O = 0 mA		15	30	mA
I <sub>CC2</sub> (Note 9)	V <sub>CC</sub> Current (Active) CMOS Inputs	$\overline{CE} = GND$ , f = 5 MHz All Inputs = V <sub>CC</sub> or GND, I/O = 0 mA		10	20	mA
I <sub>CCSB1</sub>	V <sub>CC</sub> Current (Standby) TTL Inputs	$\overline{CE} = V_{IH}$		0.1	1	mA
I <sub>CCSB2</sub>	V <sub>CC</sub> Current (Standby) CMOS Inputs	$\overline{CE} = V_{CC}$		0.5	100	μA
I <sub>PP</sub>	V <sub>PP</sub> Load Current	V <sub>PP</sub> = V <sub>CC</sub>			10	μA
V <sub>IL</sub>	Input Low Voltage		-0.2		0.8	V
V <sub>IH</sub>	Input High Voltage		2.0		V <sub>CC</sub> + 1	V
V <sub>OL1</sub>	Output Low Voltage	I <sub>OL</sub> = 2.1 mA			0.40	V
V <sub>OH1</sub>	Output High Voltage	I <sub>OH</sub> = -1.6 mA	3.5			V
V <sub>OL2</sub>	Output Low Voltage	I <sub>OL</sub> = 10 μA			0.1	V
V <sub>OH2</sub>	Output High Voltage	I <sub>OH</sub> = -10 μA	V <sub>CC</sub> - 0.1			V

**AC Electrical Characteristics**

Symbol	Parameter	Conditions	NMC27C256B						Units
			NE15, NE150		NE20, NE200		NE25, NE250		
			Min	Max	Min	Max	Min	Max	
t <sub>ACC</sub>	Address to Output Delay	$\overline{CE} = \overline{OE} = V_{IL}$		150		200		250	ns
t <sub>CE</sub>	$\overline{CE}$ to Output Delay	$\overline{OE} = V_{IL}$		150		200		250	ns
t <sub>OE</sub>	$\overline{OE}$ to Output Delay	$\overline{CE} = V_{IL}$		60		75		100	ns
t <sub>DF</sub>	$\overline{OE}$ High to Output Float	$\overline{CE} = V_{IL}$	0	50	0	55	0	60	ns
t <sub>CF</sub>	$\overline{CE}$ High to Output Float	$\overline{OE} = V_{IL}$	0	50	0	55	0	60	ns
t <sub>OH</sub>	Output Hold from Addresses, $\overline{CE}$ or $\overline{OE}$ , Whichever Occurred First	$\overline{CE} = \overline{OE} = V_{IL}$	0		0		0		ns

NMC27C256BN

**Capacitance**  $T_A = +25^\circ\text{C}$ ,  $f = 1\text{ MHz}$  (Note 2)

T-46-13-25

Symbol	Parameter	Conditions	Typ	Max	Units
$C_{IN}$	Input Capacitance	$V_{IN} = 0V$	5	10	pF
$C_{OUT}$	Output Capacitance	$V_{OUT} = 0V$	8	10	pF

**AC Test Conditions**

Output Load	1 TTL Gate and $C_L = 100\text{ pF}$ (Note 8)	Timing Measurement Reference Level	0.8V and 2V
Input Rise and Fall Times	$\leq 5\text{ ns}$	Inputs	0.8V and 2V
Input Pulse Levels	0.45V to 2.4V	Outputs	

**AC Waveforms** (Notes 6, 7 & 9)

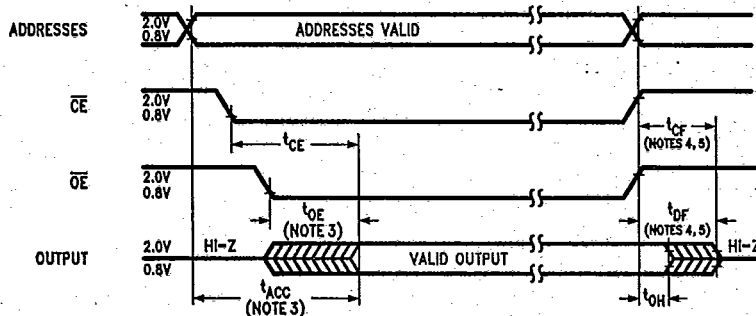

TL/D/9891-3

**Note 1:** Stresses above those listed under "Absolute Maximum Ratings" may cause permanent damage to the device. This is a stress rating only and functional operation of the device at these or any other conditions above those indicated in the operational sections of this specification is not implied. Exposure to absolute maximum rating conditions for extended periods may affect device reliability.

**Note 2:** This parameter is only sampled and is not 100% tested.

**Note 3:**  $\overline{OE}$  may be delayed up to  $t_{ACC} - t_{OE}$  after the falling edge of  $\overline{CE}$  without impacting  $t_{ACC}$ .

**Note 4:** The  $t_{DF}$  and  $t_{CF}$  compare level is determined as follows:  
 High to TRI-STATE, the measured  $V_{OH1}$  (DC) - 0.10V;  
 Low to TRI-STATE, the measured  $V_{OL1}$  (DC) + 0.10V.

**Note 5:** TRI-STATE may be attained using  $\overline{OE}$  or  $\overline{CE}$ .

**Note 6:** The power switching characteristics of EPROMs require careful device decoupling. It is recommended that at least a 0.1  $\mu\text{F}$  ceramic capacitor be used on every device between  $V_{CC}$  and GND.

**Note 7:** The outputs must be restricted to  $V_{CC} + 1.0V$  to avoid latch-up and device damage.

**Note 8:** 1 TTL Gate:  $I_{OL} = 1.8\text{ mA}$ ,  $I_{OH} = -400\ \mu\text{A}$ .  
 $C_L$ : 100 pF includes fixture capacitance.

**Note 9:**  $V_{PP}$  may be connected to  $V_{CC}$  except during programming.

**Note 10:** Inputs and outputs can undershoot to  $-2.0V$  for 20 ns Max.

**Programming Characteristics** (Notes 1, 2, 3 & 4)

T-46-13-25

Symbol	Parameter	Conditions	Min	Typ	Max	Units
$t_{AS}$	Address Setup Time		1			$\mu s$
$t_{OES}$	$\overline{OE}$ Setup Time		1			$\mu s$
$t_{DS}$	Data Setup Time		1			$\mu s$
$t_{VPS}$	$V_{PP}$ Setup Time		1			$\mu s$
$t_{VCS}$	$V_{CC}$ Setup Time		1			$\mu s$
$t_{AH}$	Address Hold Time		0			$\mu s$
$t_{DH}$	Data Hold Time		1			$\mu s$
$t_{DF}$	Output Enable to Output Float Delay		0		60	ns
$t_{PW}$	Program Pulse Width		95	100	105	$\mu s$
$t_{OE}$	Data Valid from $\overline{OE}$	$\overline{OE} = V_{IL}$			100	ns
$I_{PP}$	$V_{PP}$ Supply Current During Programming Pulse	$\overline{OE} = V_{IL}$ $\overline{OE} = V_{IH}$			30	mA
$I_{CC}$	$V_{CC}$ Supply Current				10	mA
$T_A$	Temperature Ambient		20	25	30	$^{\circ}C$
$V_{CC}$	Power Supply Voltage		6.0	6.25	6.5	V
$V_{PP}$	Programming Supply Voltage		12.5	12.75	13.0	V
$t_{FR}$	Input Rise, Fall Time		5			ns
$V_{IL}$	Input Low Voltage			0.0	0.45	V
$V_{IH}$	Input High Voltage		2.4	4.0		V
$t_{IN}$	Input Timing Reference Voltage		0.8	1.5	2.0	ns
$t_{OUT}$	Output Timing Reference Voltage		0.8	1.5	2.0	ns

**Programming Waveforms**

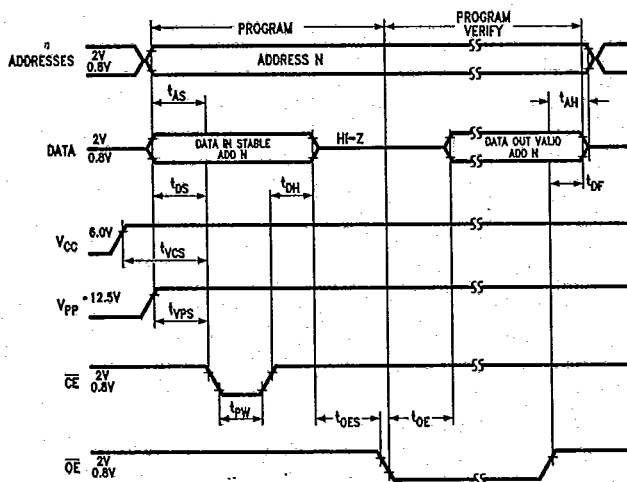

TL/D/9691-4

**Note 1:** National's standard product warranty applies only to devices programmed to specifications described herein.

**Note 2:**  $V_{CC}$  must be applied simultaneously or before  $V_{PP}$  and removed simultaneously or after  $V_{PP}$ . The EPROM must not be inserted into or removed from a board with voltage applied to  $V_{PP}$  or  $V_{CC}$ .

**Note 3:** The maximum absolute allowable voltage which may be applied to the  $V_{PP}$  pin during programming is 14V. Care must be taken when switching the  $V_{PP}$  supply to prevent any overshoot from exceeding this 14V maximum specification. At least a 0.1  $\mu F$  capacitor is required across  $V_{PP}$ ,  $V_{CC}$  to GND to suppress spurious voltage transients which may damage the device.

**Note 4:** Programming and program verify are tested with the fast Program Algorithm, at typical power supply voltages and timings.

NMC27C256BN

### Fast Programming Algorithm Flow Chart (Note 4)

T-46-13-25

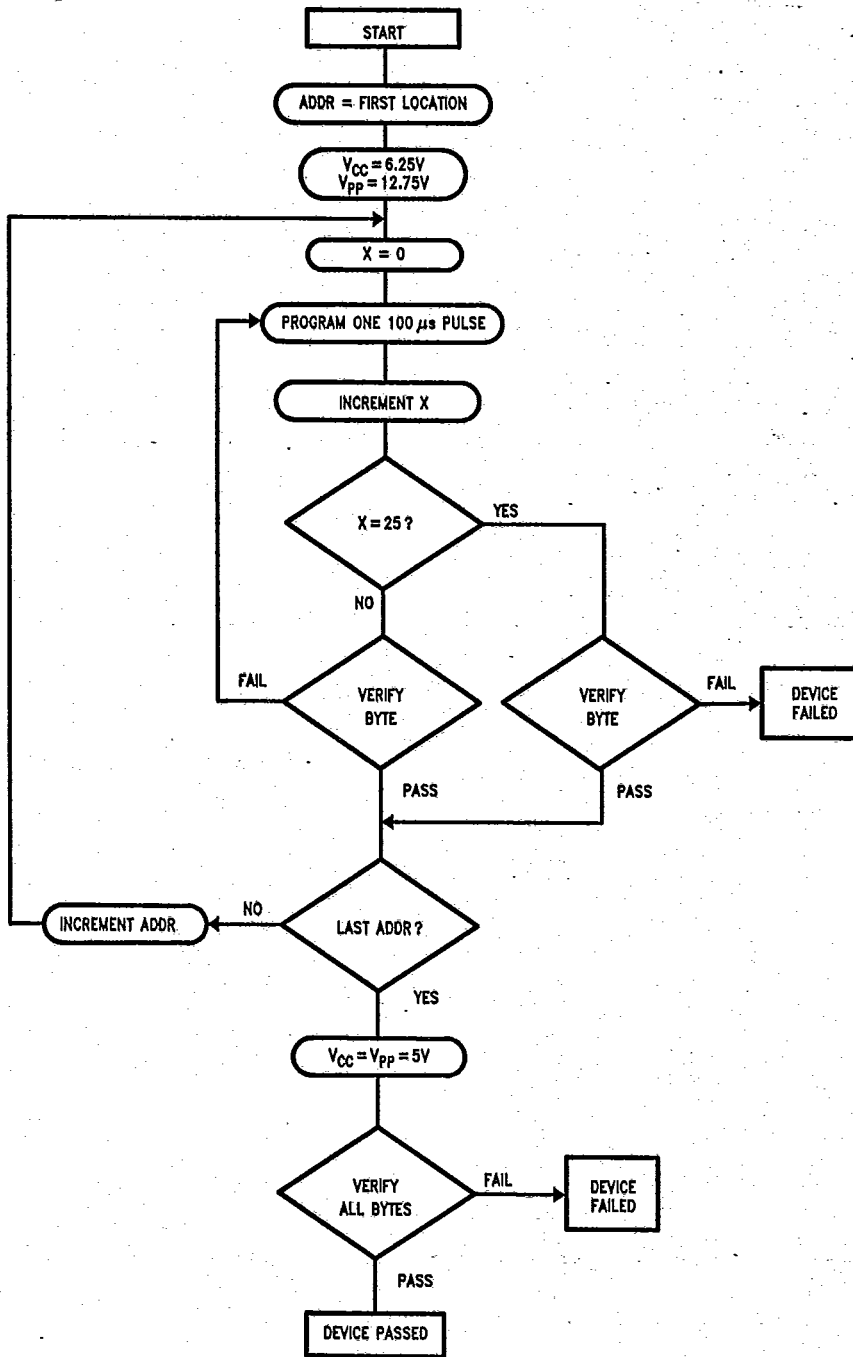

FIGURE 1

TL/D/8691-5

T-46-13-25

NMC27C256BN

### Interactive Programming Algorithm Flow Chart (Note 4)

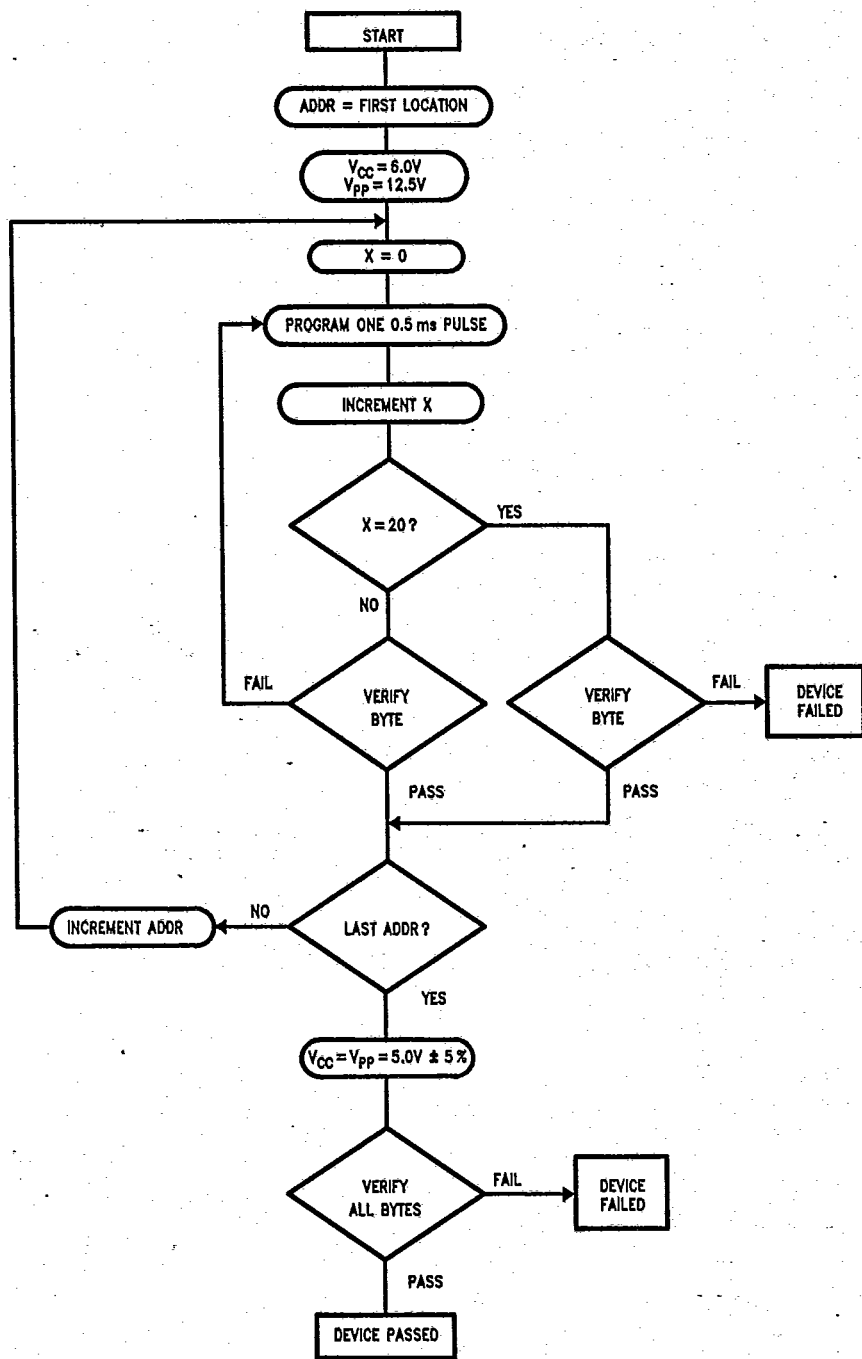

FIGURE 2

TL/D/0691-8



T-46-13-25

NMC27C256BN

## Functional Description

### DEVICE OPERATION

The six modes of operation of the NMC27C256BN are listed in Table I. It should be noted that all inputs for the six modes are at TTL levels. The power supplies required are  $V_{CC}$  and  $V_{PP}$ . The  $V_{PP}$  power supply must be at 12.75V during the three programming modes, and must be at 5V in the other three modes. The  $V_{CC}$  power supply must be at 6.25V during the three programming modes, and at 5V in the other three modes.

### Read Mode

The NMC27C256BN has two control functions, both of which must be logically active in order to obtain data at the outputs. Chip Enable ( $\overline{CE}$ ) is the power control and should be used for device selection. Output Enable ( $\overline{OE}$ ) is the output control and should be used to gate data to the output pins, independent of device selection. Assuming that addresses are stable, address access time ( $t_{ACC}$ ) is equal to the delay from  $\overline{CE}$  to output ( $t_{CE}$ ). Data is available at the outputs  $t_{OE}$  after the falling edge of  $\overline{OE}$ , assuming that  $\overline{CE}$  has been low and addresses have been stable for at least  $t_{ACC} - t_{OE}$ .

The sense amps are clocked for fast access time.  $V_{CC}$  should therefore be maintained at operating voltage during read and verify. If  $V_{CC}$  temporarily drops below the spec. voltage (but not to ground) an address transition must be performed after the drop to insure proper output data.

### Standby Mode

The NMC27C256BN has a standby mode which reduces the active power dissipation by over 99%, from 110 mW to 0.55 mW. The NMC27C256BN is placed in the standby mode by applying a CMOS high signal to the  $\overline{CE}$  input. When in standby mode, the outputs are in a high impedance state, independent of the  $\overline{OE}$  input.

### Output OR-Tying

Because NMC27C256BN are usually used in larger memory arrays, National has provided a 2-line control function that accommodates this use of multiple memory connections. The 2-line control function allows for:

- the lowest possible memory power dissipation, and
- complete assurance that output bus contention will not occur.

To most efficiently use these two control lines, it is recommended that  $\overline{CE}$  (pin 20) be decoded and used as the primary device selecting function, while  $\overline{OE}$  (pin 22) be made a common connection to all devices in the array and connected to the READ line from the system control bus. This assures that all deselected memory devices are in their low power standby modes and that the output pins are active only when data is desired from a particular memory device.

### Programming

**CAUTION:** Exceeding 14V on pin 1 ( $V_{PP}$ ) will damage the NMC27C256BN.

Initially, and after each erasure, all bits of the NMC27C256BN are in the "1" state. Data is introduced by selectively programming "0s" into the desired bit locations. Although only "0s" will be programmed, both "1s" and "0s" can be presented in the data word. The only way to change a "0" to a "1" is by ultraviolet light erasure.

The NMC27C256BN is in the programming mode when the  $V_{PP}$  power supply is at 12.75V and  $\overline{OE}$  is at  $V_{IH}$ . It is required that at least a 0.1  $\mu$ F capacitor be placed across  $V_{PP}$ ,  $V_{CC}$  to ground to suppress spurious voltage transients which may damage the device. The data to be programmed is applied 8 bits in parallel to the data output pins. The levels required for the address and data inputs are TTL.

When the address and data are stable, an active low TTL program pulse is applied to the  $\overline{CE}$  input. A program pulse must be applied at each address location to be programmed. The NMC27C256BN is programmed with the Fast Programming Algorithm shown in Figure 1. Each Address is programmed with a series of 100  $\mu$ s pulses until it verifies good, up to a maximum of 25 pulses. Most memory cells will program with a single 100  $\mu$ s pulse. The NMC27C256BN must not be programmed with a DC signal applied to the  $\overline{CE}$  input.

**Note:** Some program manufacturers due to equipment limitation may offer interactive program Algorithm (shown in Figure 2).

Programming multiple NMC27C256BNs in parallel with the same data can be easily accomplished due to the simplicity of the programming requirements. Like inputs of the parallel NMC27C256BNs may be connected together when they are programmed with the same data. A low level

TABLE I. Mode Selection

Mode	Pins	$\overline{CE}$ (20)	$\overline{OE}$ (22)	$V_P$ (1)	$V_{CC}$ (28)	Outputs (11-13, 15-19)
Read		$V_{IL}$	$V_{IL}$	5V	5V	$D_{OUT}$
Standby		$V_{IH}$	Don't Care	5V	5V	Hi-Z
Output Disable		Don't Care	$V_{IH}$	5V	5V	Hi-Z
Program		$V_{IL}$	$V_{IH}$	12.75V	6.25V	$D_{IN}$
Program Verify		$V_{IH}$	$V_{IL}$	12.75V	6.25V	$D_{OUT}$
Program Inhibit		$V_{IH}$	$V_{IH}$	12.75V	6.25V	Hi-Z

**Functional Description** (Continued)

TTL pulse applied to the  $\overline{CE}$  input programs the paralleled NMC27C256BNs.

The NMC27C256BN is packaged in a plastic molded package which does not have a transparent lid. Therefore the memory cannot be erased. This means that after a user has programmed a memory cell to a "0" it cannot be changed back to a "1".

If an application requires erasing and reprogramming, the NMC27C256BQ UV erasable PROM in a windowed package should be used.

**Program Inhibit**

Programming multiple NMC27C256BNs in parallel with different data is also easily accomplished. Except  $\overline{CE}$ , all like inputs (including  $\overline{OE}$ ) of the parallel NMC27C256BNs may be common. A TTL low level program pulse applied to an NMC27C256BNs  $\overline{CE}$  input with  $V_{PP}$  at 12.75V will program that NMC27C256BN. A TTL high level  $\overline{CE}$  input inhibits the other NMC27C256BNs from being programmed.

**Program Verify**

A verify should be performed on the programmed bits to determine whether they were correctly programmed. The verify may be performed with  $V_{PP}$  at 12.75V.  $V_{PP}$  must be at  $V_{CC}$  except during programming and program verify.

**Manufacturer's Identification Code**

The NMC27C256BN has a manufacturer's identification code to aid in programming. When the device is inserted in an EPROM programmer socket, the programmer reads the code and then automatically calls up the specific programming algorithm for the part. This automatic programming control is only possible with programmers which have the capability of reading the code.

The Manufacturer's Identification code, shown in Table II, specifically identifies the manufacturer and the device type. The code for NMC27C256BN is "8F04", where "8F" designates that it is made by National Semiconductor, and "04" designates a 256k part.

The code is accessed by applying 12.0V  $\pm$  0.5V to address pin A9. Addresses A1-A8, A10-A14, and all control pins are held at  $V_{IL}$ . Address pin A0 is held at  $V_{IL}$  for the manufacturer's code, and held at  $V_{IH}$  for the device code. The code is read on the eight data pins, O<sub>0</sub>-O<sub>7</sub>. Proper code access is only guaranteed at 25°C  $\pm$  5°C.

**SYSTEM CONSIDERATION**

The power switching characteristics of EPROMs require careful decoupling of the devices. The supply current,  $I_{CC}$ , has three segments that are of interest to the system designer—the standby current level, the active current level, and the transient current peaks that are produced by voltage transitions on input pins. The magnitude of these transient current peaks is dependent on the output capacitance loading of the device. The associated  $V_{CC}$  transient voltage peaks can be suppressed by properly selected decoupling capacitors. It is recommended that at least a 0.1  $\mu$ F ceramic capacitor be used on every device between  $V_{CC}$  and GND. This should be a high frequency capacitor of low inherent inductance. In addition, at least a 4.7  $\mu$ F bulk electrolytic capacitor should be used between  $V_{CC}$  and GND for each eight devices. The bulk capacitor should be located near where the power supply is connected to the array. The purpose of the bulk capacitor is to overcome the voltage drop caused by the inductive effects of the PC board traces.

TABLE II. Manufacturer's Identification Code

Pins	A <sub>0</sub> (10)	O <sub>7</sub> (19)	O <sub>6</sub> (18)	O <sub>5</sub> (17)	O <sub>4</sub> (16)	O <sub>3</sub> (15)	O <sub>2</sub> (13)	O <sub>1</sub> (12)	O <sub>0</sub> (11)	Hex Data
Manufacturer Code	$V_{IL}$	1	0	0	0	1	1	1	1	8F
Device Code	$V_{IH}$	0	0	0	0	0	1	0	0	04

NMC27C256BN

T-46-13-25

### Packaging Information

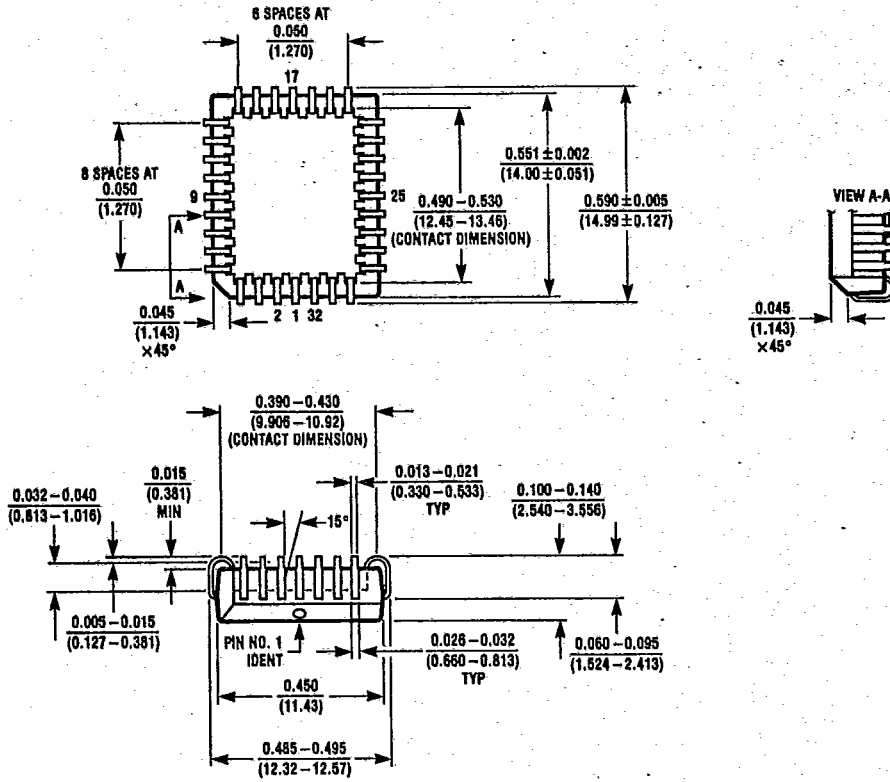

32-Lead PLCC Package  
Order Number NMC27C256

TL/D/9691-7