

FDZ8040L

Integrated Load Switch

Features

- Optimized for Low-Voltage Core ICs in Portable Systems
- Very Small Package Dimension: WLCSP 0.8 X 0.8 X 0.5 mm³
- Current = 1.2 A, V_{IN} Max. = 4 V
- Current = 2 A, V_{IN} Max. = 4 V (Pulsed)
- R_{DS(on)} = 80 mΩ at V_{ON} = V_{IN} = 4 V
- R_{DS(on)} = 85 mΩ at V_{ON} = V_{IN} = 3.6 V
- R_{DS(on)} = 90 mΩ at V_{ON} = V_{IN} = 3 V
- R_{DS(on)} = 360 mΩ at V_{ON} = V_{IN} = 0.9 V
- R_{DS(on)} = 1000 mΩ at V_{ON} = V_{IN} = 0.8 V
- RoHS Compliant

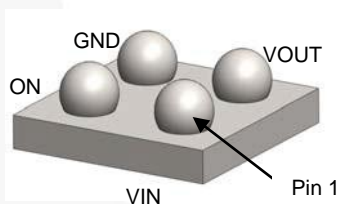

Figure 1. Bottom View

Description

This device is particularly suited for compact power management in portable applications needing 0.8 V to 4 V input and 1.2 A output current capability. This load switch integrated a level-shifting function that drives a P-channel power MOSFET in a very small 0.8 X 0.8 X 0.5 mm³ WLCSP package.

Applications

- Load Switch
- Power Management in Portable Applications

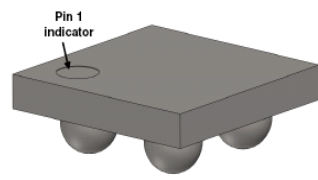

Figure 2. Top View

Ordering Information

Part Number	Device Mark	Ball Pitch	Operating Temperature Range	Switch	Package	Packing Method
FDZ8040L	ZM	0.4 mm	-40 to 85°C	80 mΩ, P-Channel MOSFET	0.8 x 0.8 x 0.5 mm ³ WLCSP	Tape & Reel

Typical Application

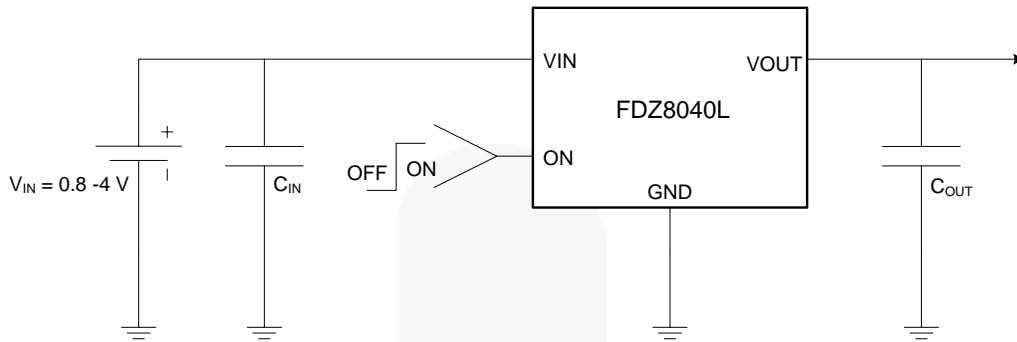

Figure 3. Typical Application

Block Diagram

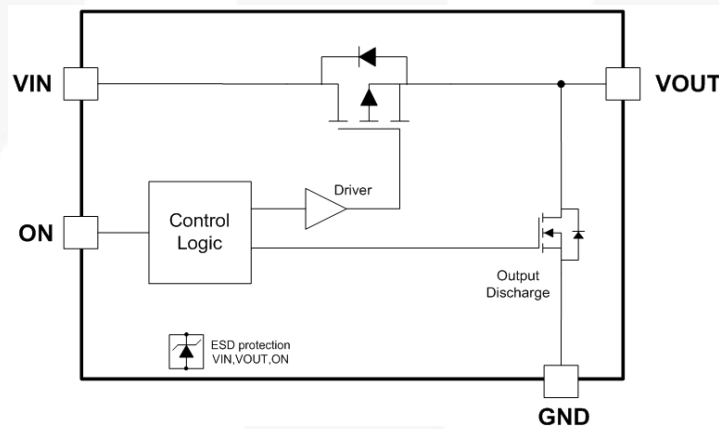

Figure 4. Internal Block Diagram

Pin Configuration

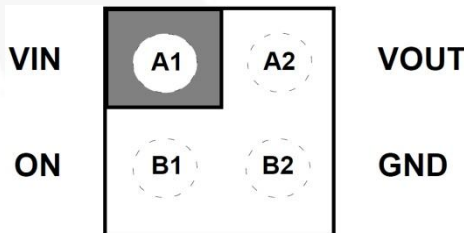

Figure 5. Top View (Bumps Down)

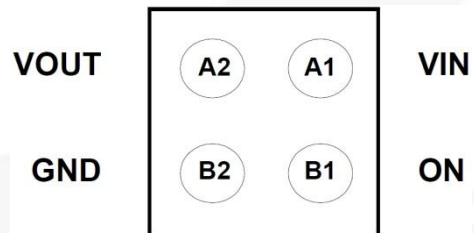

Figure 6. Bottom View (Bumps Up)

Pin Descriptions

Pin #	Name	Description
A1	VIN	Supply Input: Input to the load switch
A2	VOUT	Switch Output: Output of the load switch
B1	ON	ON/OFF Control Input
B2	GND	Ground

Absolute Maximum Ratings

Stresses exceeding the absolute maximum ratings may damage the device. The device may not function or be operable above the recommended operating conditions and stressing the parts to these levels is not recommended. In addition, extended exposure to stresses above the recommended operating conditions may affect device reliability. The absolute maximum ratings are stress ratings only.

Symbol	Parameter	Min.	Max.	Unit
V_{IN}	Voltage on VIN, VOUT, ON to GND	-0.3	4.2	V
I_{OUT_C}	I_{OUT} -Load Current (Continuous) ^(1a)		1.2	A
I_{OUT_P}	I_{OUT} -Load Current (Pulsed)		2	A
P_D	Power Dissipation at $T_A = 25^\circ\text{C}$ ^(1a)		0.9	W
T_A	Operating Temperature Range	-40	85	$^\circ\text{C}$
T_{STG}	Storage Temperature	-65	150	$^\circ\text{C}$
$R\theta_{JA}$	Thermal Resistance, Junction to Ambient ^(1a)		135	$^\circ\text{C}/\text{W}$
ESD	Electrostatic Discharge Capability	Human Body Model, JESD22-A114	8	kV
		Charged Device Model, JESD22-C101	2	

Notes:

- $R\theta_{JA}$ is the sum of the junction-to-case and case-to-ambient thermal resistance where the case thermal reference is defined as the solder mounting surface of the drain pins. $R\theta_{JC}$ is guaranteed by design, while $R\theta_{JA}$ is determined by the board design.

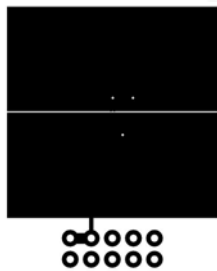

- a. $135^\circ\text{C}/\text{W}$ when mounted on a 1-inch square pad of 2-oz copper.

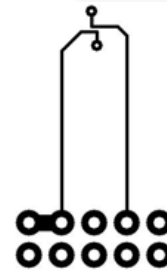

- b. $360^\circ\text{C}/\text{W}$ when mounted on a minimum pad of 2-oz copper.

- Pulse test: pulse width < 300 μs ; duty cycle < 2.0%.

Recommended Operating Conditions

The Recommended Operating Conditions table defines the conditions for actual device operation. Recommended operating conditions are specified to ensure optimal performance to the datasheet specifications. Fairchild does not recommend exceeding them or designing to Absolute Maximum Ratings.

Symbol	Parameter	Min.	Max.	Unit
V_{IN}	Voltage on VIN Pin	0.8	4.0	V
V_{ON}	Voltage on ON Pin	0.7	4.0	V
T_A	Operating Temperature Range	1 V to 4 V	-40	85
		0.8 V to 4 V	-10	

Electrical Characteristics

$T_J = 25^\circ\text{C}$ and $V_{IN} = 1.8\text{ V}$, unless otherwise noted.

Symbol	Parameter	Test Conditions	Min.	Typ.	Max.	Unit
V_{IN}	Operation Voltage		0.8		4.0	V
V_{IL}	ON Input Logic Low Voltage	$1.6\text{ V} \leq V_{IN} \leq 4.0\text{ V}$			0.35	V
		$0.8\text{ V} \leq V_{IN} \leq 1.6\text{ V}$			0.25	
V_{IH}	ON Input Logic High Voltage	$1.6\text{ V} \leq V_{IN} \leq 4.0\text{ V}$	1.0			V
		$0.8\text{ V} \leq V_{IN} \leq 1.6\text{ V}$	0.7			
I_Q	Quiescent Current	$I_{OUT} = 0\text{ mA}$, $V_{IN} = V_{ON} = 1.8\text{ V}$			2.1	μA
$I_{Q(off)}$	Off Supply Current	$I_{OUT} = 0\text{ mA}$, $V_{IN} = 1.8\text{ V}$, $V_{ON} = \text{GND}$			1	μA
$I_{SD(off)}$	Off Switch Current	$V_{ON} = \text{GND}$, $V_{OUT} = 0\text{ V}$, $V_{IN} = 1.8\text{ V}$			100	nA
I_{ON}	ON Input Leakage	$V_{ON} = V_{IN}$ or GND			1	μA
R_{PD}	Output Discharge Pull-Down Resistance			200		Ω
$R_{DS(ON)}$	Static Drain-Source On-Resistance	$V_{ON} = V_{IN} = 4\text{ V}$, $I_{OUT} = 300\text{ mA}$		50	80	m Ω
		$V_{ON} = V_{IN} = 3.6\text{ V}$, $I_{OUT} = 300\text{ mA}$		51	85	
		$V_{ON} = V_{IN} = 3\text{ V}$, $I_{OUT} = 300\text{ mA}$		54	90	
		$V_{ON} = 0.7\text{ V}$, $V_{IN} = 1.6\text{ V}$, $I_{OUT} = 300\text{ mA}$		73	110	
		$V_{ON} = 0.7\text{ V}$, $V_{IN} = 1\text{ V}$, $I_{OUT} = 300\text{ mA}$		140	309	
		$V_{ON} = V_{IN} = 0.9\text{ V}$, $I_{OUT} = 10\text{ mA}$		186	360	
		$V_{ON} = V_{IN} = 0.8\text{ V}$, $I_{OUT} = 10\text{ mA}$		348	1000	
		$V_{ON} = V_{IN} = 0.9\text{ V}$, $I_{OUT} = 10\text{ mA}$, $T_J = 10 \sim 85^\circ\text{C}$		194	370	
		$V_{ON} = V_{IN} = 0.8\text{ V}$, $I_{OUT} = 10\text{ mA}$, $T_J = 10 \sim 85^\circ\text{C}$		268	750	
		$V_{IN} = 3.6\text{ V}$, $I_{OUT} = 300\text{ mA}$, $T_J = 85^\circ\text{C}$		59	102	

Switching Characteristics

Symbol	Parameter	Test Conditions	Typical	Unit
$t_{d(on)}$	Turn-On Delay Time	$V_{IN} = 1.6\text{ V}, V_{ON} = 0.7\text{ V}, C_L = 1\ \mu\text{F}, R_L = 500\ \Omega$	22	μs
t_r	Turn-On Rise Time		23	μs
$t_{d(off)}$	Turn-Off Delay Time		109	μs
t_f	Turn-Off Fall Time		285	μs
$t_{d(on)}$	Turn-On Delay Time	$V_{IN} = 1\text{ V}, V_{ON} = 1.8\text{ V}, C_L = 1\ \mu\text{F}, R_L = 500\ \Omega$	37	μs
t_r	Turn-On Rise Time		35	μs
$t_{d(off)}$	Turn-Off Delay Time		112	μs
t_f	Turn-Off Fall Time		332	μs
$t_{d(on)}$	Turn-On Delay Time	$V_{IN} = 1.8\text{ V}, V_{ON} = 1.8\text{ V}, C_L = 1\ \mu\text{F}, R_L = 500\ \Omega$	20	μs
t_r	Turn-On Rise Time		22	μs
$t_{d(off)}$	Turn-Off Delay Time		122	μs
t_f	Turn-Off Fall Time		296	μs
$t_{d(on)}$	Turn-On Delay Time	$V_{IN} = 2.5\text{ V}, V_{ON} = 1.8\text{ V}, C_L = 1\ \mu\text{F}, R_L = 500\ \Omega$	15	μs
t_r	Turn-On Rise Time		19	μs
$t_{d(off)}$	Turn-Off Delay Time		160	μs
t_f	Turn-Off Fall Time		295	μs
$t_{d(on)}$	Turn-On Delay Time	$V_{IN} = 3.3\text{ V}, V_{ON} = 1.8\text{ V}, C_L = 1\ \mu\text{F}, R_L = 500\ \Omega$	13	μs
t_r	Turn-On Rise Time		18	μs
$t_{d(off)}$	Turn-Off Delay Time		193	μs
t_f	Turn-Off Fall Time		305	μs
$t_{d(on)}$	Turn-On Delay Time	$V_{IN} = 0.8\text{ V}, V_{ON} = 0.8\text{ V}, C_L = 1\ \mu\text{F}, R_L = 500\ \Omega$	53	μs
t_r	Turn-On Rise Time		56	μs
$t_{d(off)}$	Turn-Off Delay Time		143	μs
t_f	Turn-Off Fall Time		532	μs
$t_{d(on)}$	Turn-On Delay Time	$V_{IN} = 0.9\text{ V}, V_{ON} = 0.9\text{ V}, C_L = 1\ \mu\text{F}, R_L = 500\ \Omega$	51	μs
t_r	Turn-On Rise Time		54	μs
$t_{d(off)}$	Turn-Off Delay Time		148	μs
t_f	Turn-Off Fall Time		525	μs

Typical Performance Characteristics

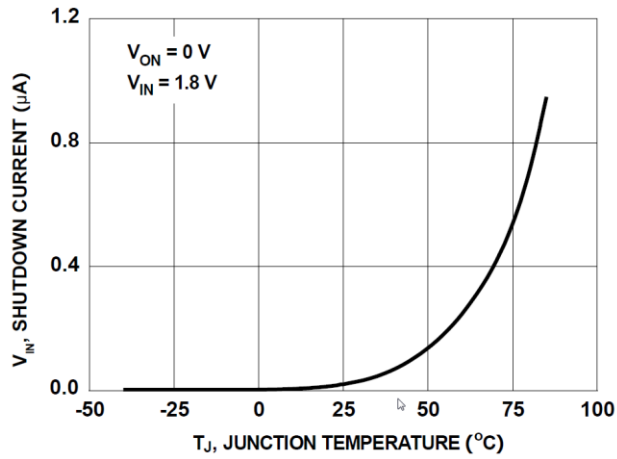

Figure 7. Shutdown Current vs. Temperature

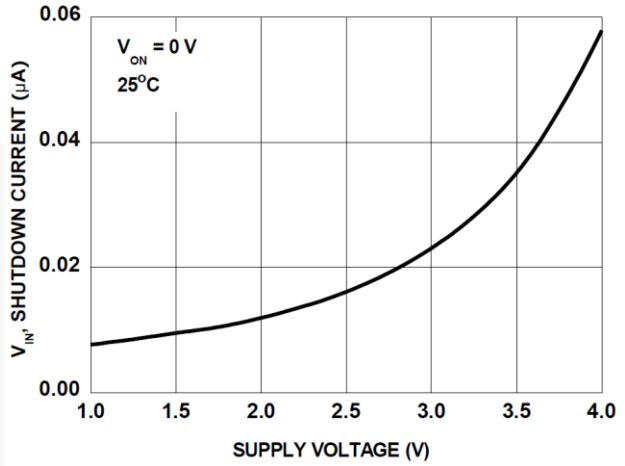

Figure 8. Shutdown Current vs. Supply Voltage

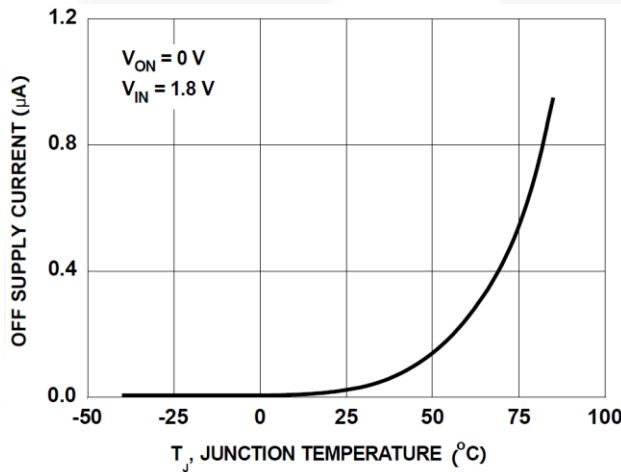

Figure 9. Off Supply Current vs. Temperature

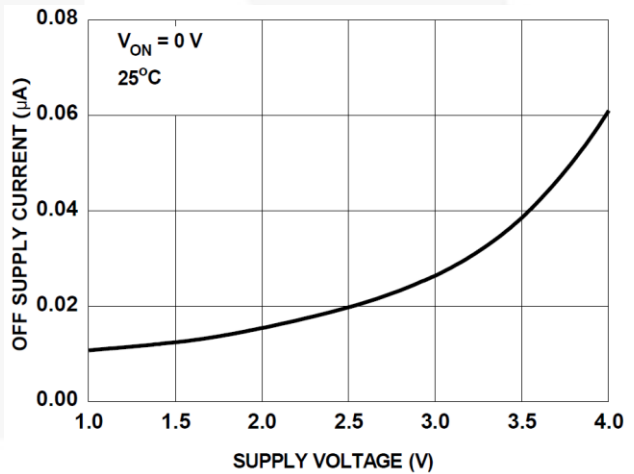

Figure 10. Off Supply Current vs. Supply Voltage

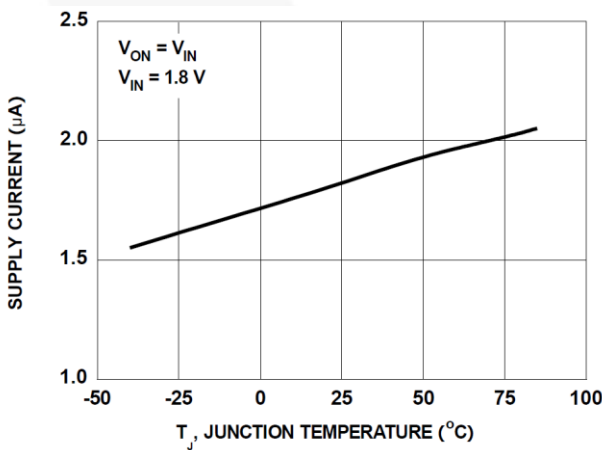

Figure 11. Quiescent Current vs. Temperature

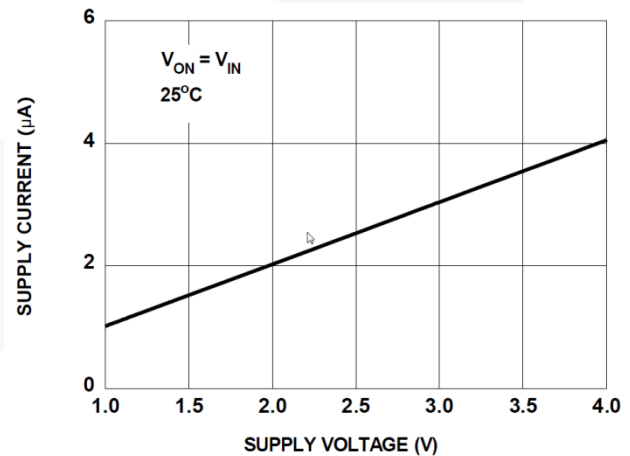

Figure 12. Quiescent Current vs. Supply Voltage

Typical Performance Characteristics

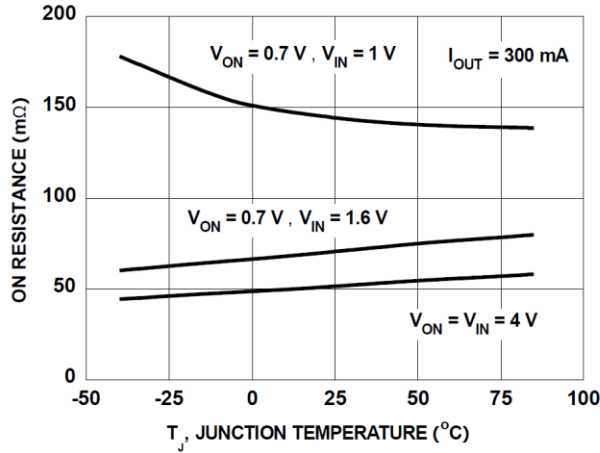

Figure 13. R_{ON} vs. Temperature

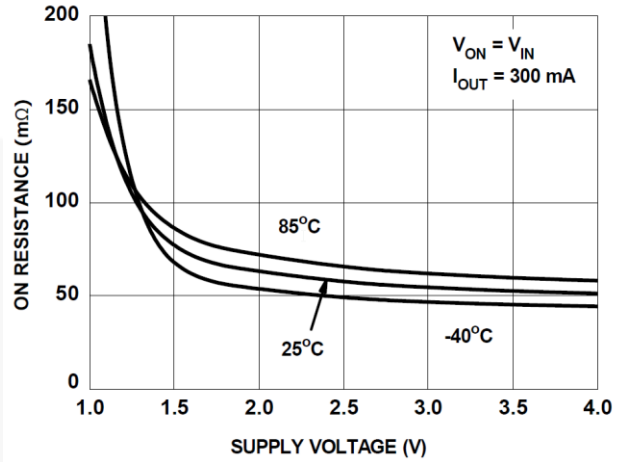

Figure 14. R_{ON} vs. Supply Voltage

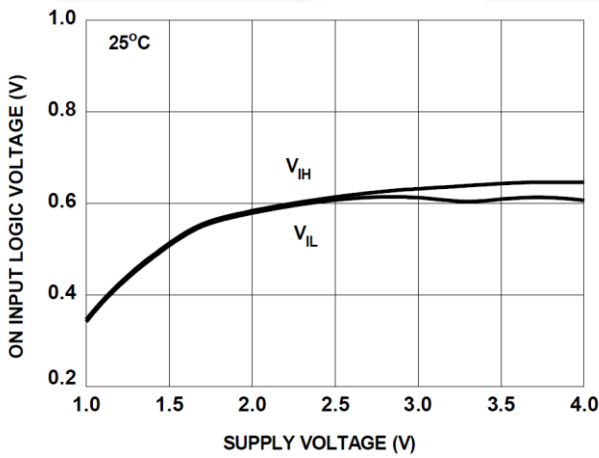

Figure 15. ON-Pin Threshold vs. V_{IN}

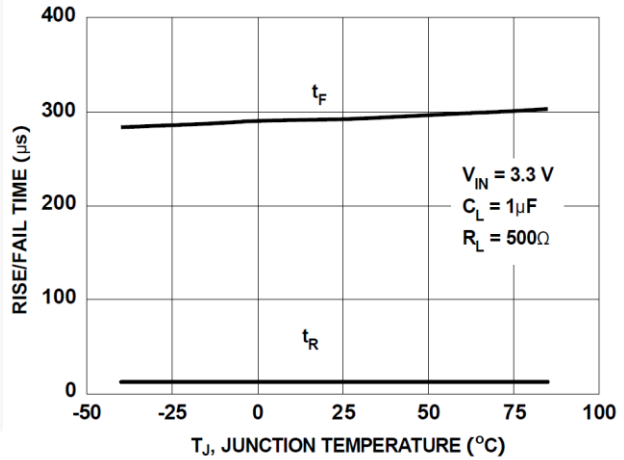

Figure 16. V_{OUT} Rise and Fall Time vs. Temperature at $R_L=500\Omega$

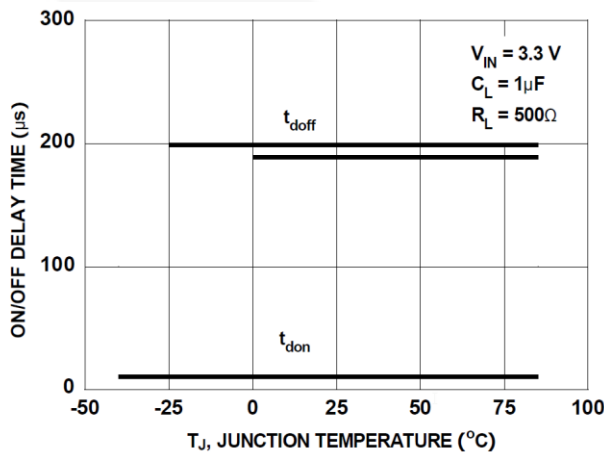

Figure 17. V_{OUT} Turn-On and Turn-Off Delay vs. Temperature at $R_L=500\Omega$

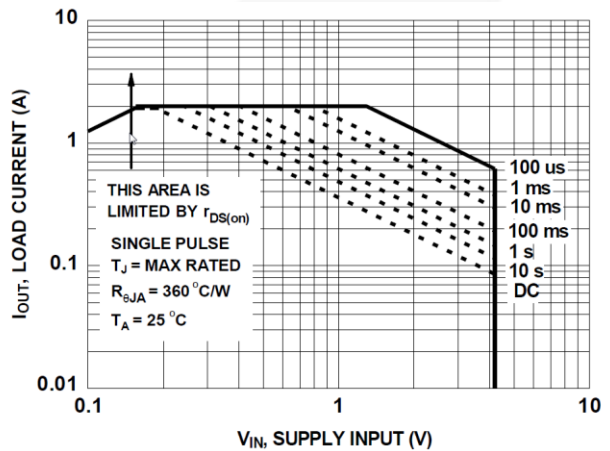

Figure 18. Forward Bias Safe Operation Area

Typical Performance Characteristics

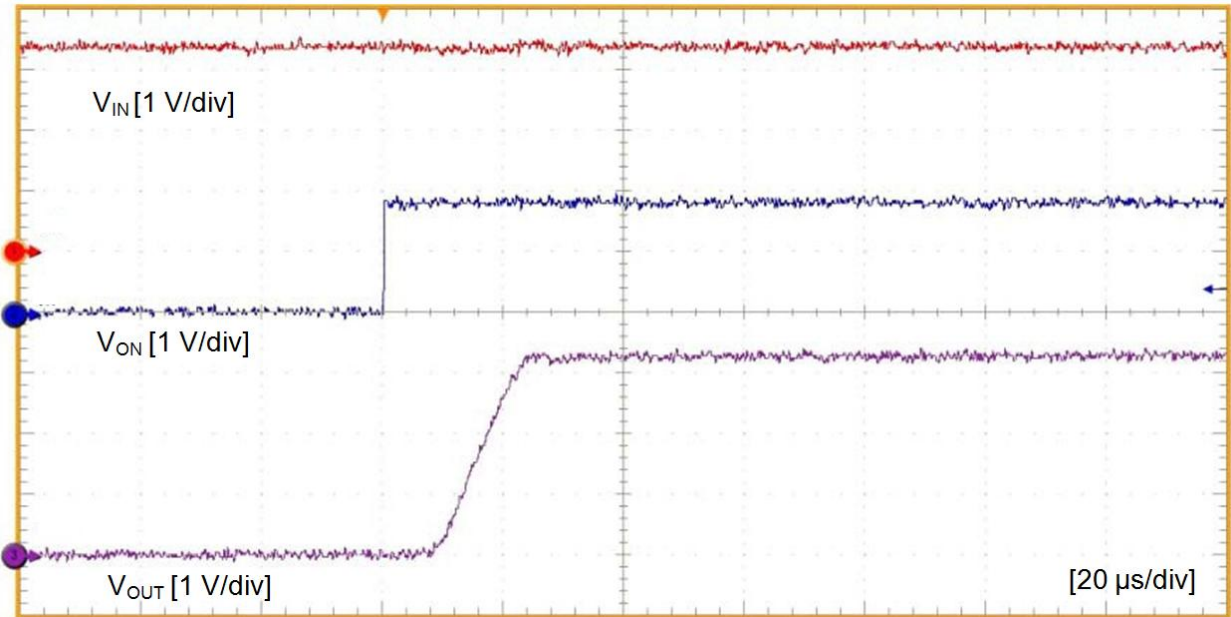

Figure 19. Turn-On Response ($V_{IN} = 3.3$ V, $C_{OUT} = 1$ μ F, $R_L = 500$ Ω)

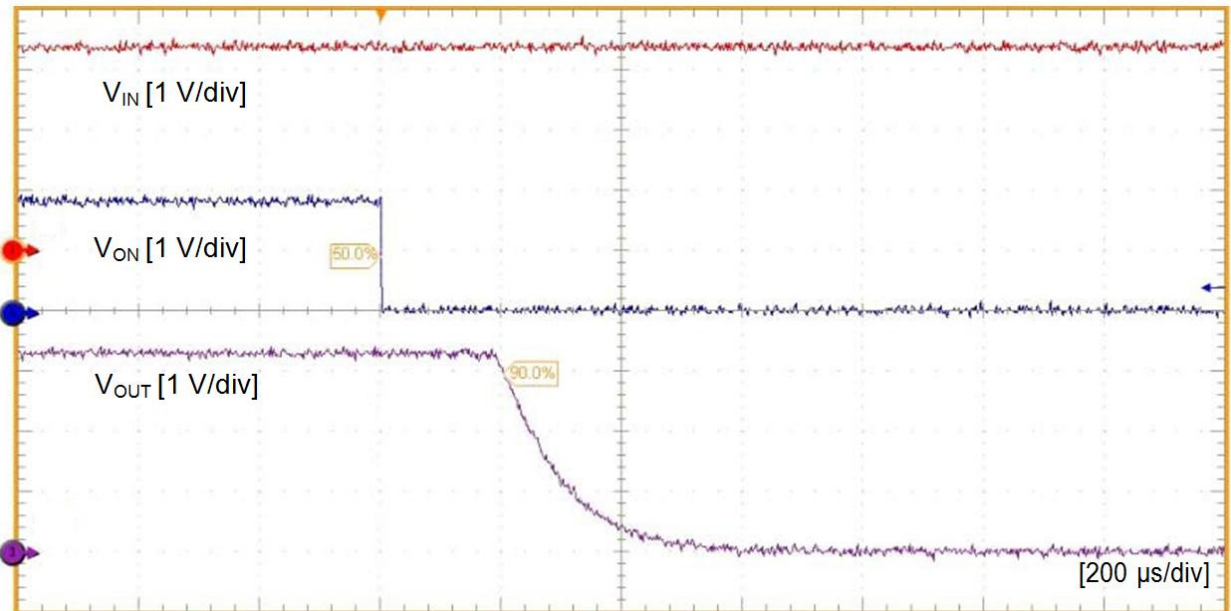

Figure 20. Turn-Off Response ($V_{IN} = 3.3$ V, $C_{OUT} = 1$ μ F, $R_L = 500$ Ω)

Functional Description

The FDZ8040L is a low- $R_{DS(ON)}$ P-channel load switch packaged in space-saving 0.8 x 0.8 WLCSP.

The core of the device is an 80 m Ω P-channel MOSFET capable of functioning over a wide input operating range

of 0.8-4 V. The ON pin, an active HIGH TTL-compatible input that supports input as low as 0.7 V, controls the state of the switch.

Applications Information

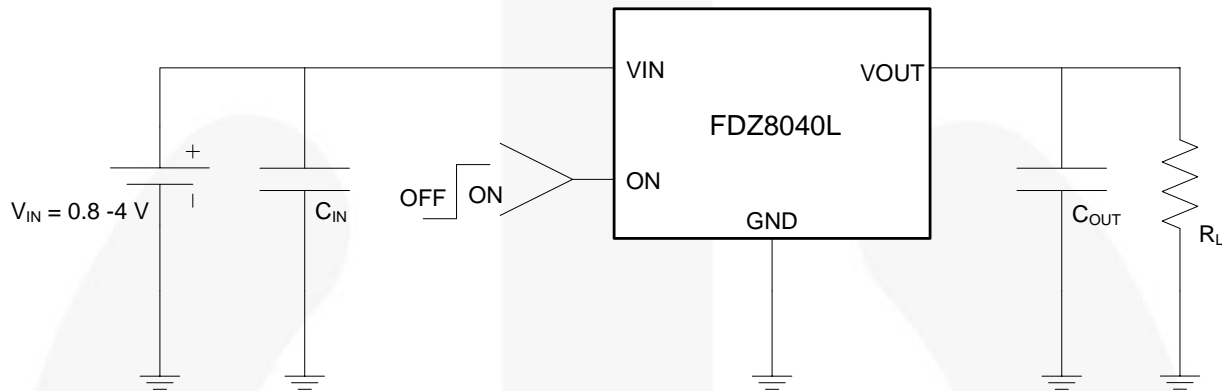

Figure 21. Typical Application

Input Capacitor

To reduce device inrush current effect, a 0.1 μF ceramic capacitor, C_{IN} , is recommended close to the VIN pin. A higher value of C_{IN} can be used to further reduce the voltage drop experienced as the switch is turned on into a large capacitive load.

Output Capacitor

FDZ8040L works without an output capacitor. However, if parasitic board inductance forces V_{OUT} below GND when switching off, a 0.1 μF capacitor, C_{OUT} , should be placed between the VOUT and GND pins.

Physical Dimensions

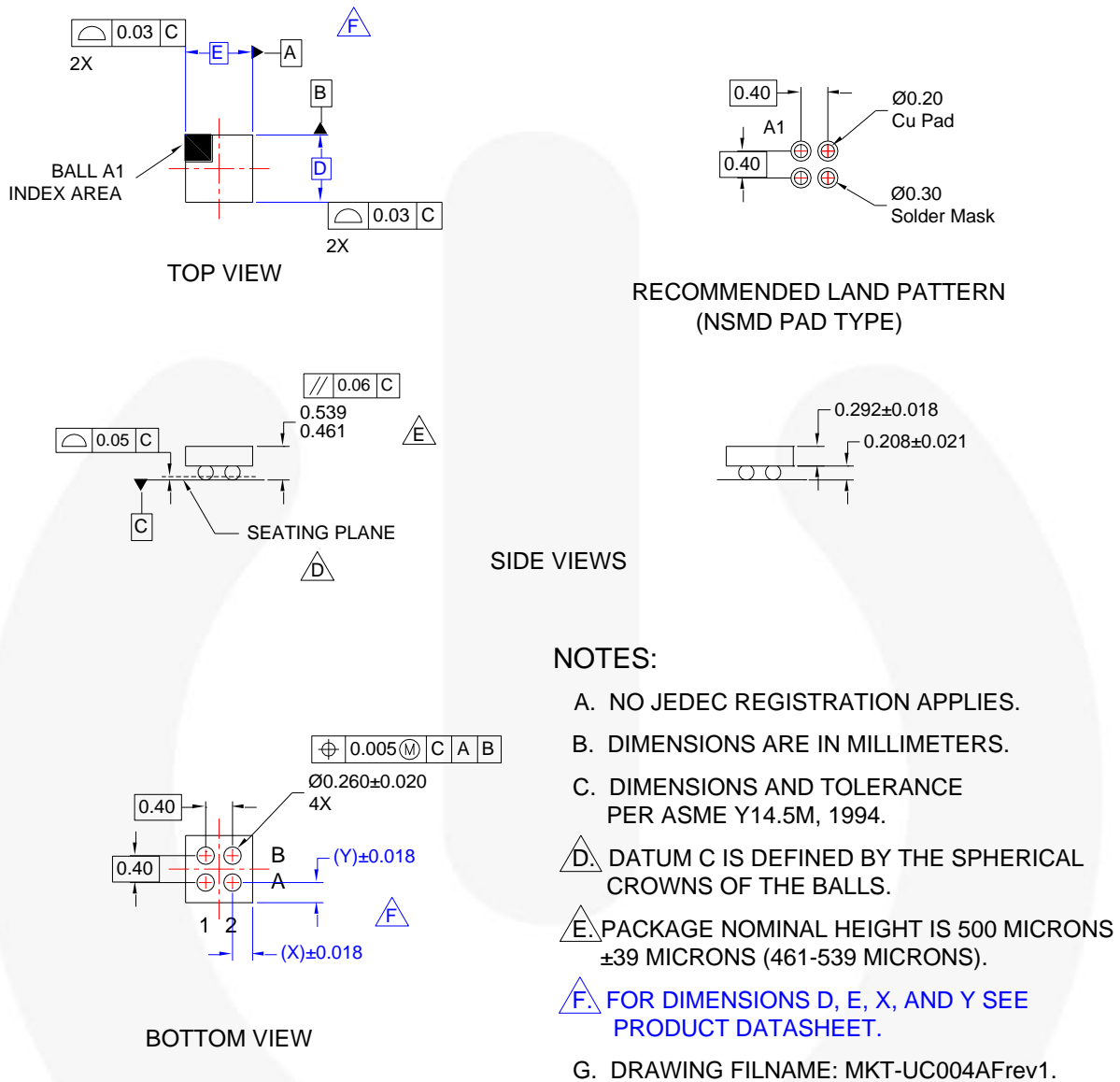

Figure 22. 4-Ball, WLCSP, 2 X 2 Array, 0.4 mm Pitch, 250 µm Ball

Product-Specific Dimensions

Product	D	E	X	Y
FDZ8040L	0.8 \pm 0.03 mm	0.8 \pm 0.03 mm	0.21 mm	0.21 mm

Package drawings are provided as a service to customers considering Fairchild components. Drawings may change in any manner without notice. Please note the revision and/or date on the drawing and contact a Fairchild Semiconductor representative to verify or obtain the most recent revision. Package specifications do not expand the terms of Fairchild's worldwide terms and conditions, specifically the warranty therein, which covers Fairchild products.

Always visit Fairchild Semiconductor's online packaging area for the most recent package drawings:
<http://www.fairchildsemi.com/packaging/>



TRADEMARKS

The following includes registered and unregistered trademarks and service marks, owned by Fairchild Semiconductor and/or its global subsidiaries, and is not intended to be an exhaustive list of all such trademarks.

- | | | | |
|--------------------------|--|---------------------------------------|------------------|
| 2Cool™ | FPS™ | | Sync-Lock™ |
| AccuPower™ | F-PFS™ | PowerTrench® | SYSTEM GENERAL® |
| AX-CAP®* | FRFET® | PowerXS™ | TinyBoost™ |
| BitSiC™ | Global Power Resource™ | Programmable Active Droop™ | TinyBuck™ |
| Build it Now™ | GreenBridge™ | QFET® | TinyCalc™ |
| CorePLUS™ | Green FPS™ | QS™ | TinyLogic® |
| CorePOWER™ | Green FPS™ e-Series™ | Quiet Series™ | TINYOPTO™ |
| CROSSVOLT™ | Gmax™ | RapidConfigure™ | TinyPower™ |
| CTL™ | GTO™ | | TinyPWM™ |
| Current Transfer Logic™ | IntelliMAX™ | Saving our world, 1mW/W/kW at a time™ | TinyWire™ |
| DEUXPEED® | ISOPLANAR™ | SignalWise™ | TranSiC™ |
| Dual Cool™ | Making Small Speakers Sound Louder and Better™ | SmartMax™ | TriFault Detect™ |
| EcoSPARK® | MegaBuck™ | SMART START™ | TRUECURRENT®* |
| EfficientMax™ | MICROCOUPLER™ | Solutions for Your Success™ | µSerDes™ |
| ESBC™ | MicroFET™ | SPM® | |
| | MicroPak™ | STEALTH™ | UHC® |
| Fairchild® | MicroPak2™ | SuperFET® | Ultra FRFET™ |
| Fairchild Semiconductor® | MillerDrive™ | SuperSOT™-3 | UniFET™ |
| FACT Quiet Series™ | MotionMax™ | SuperSOT™-6 | VCX™ |
| FACT® | mWSaver™ | SuperSOT™-8 | VisualMax™ |
| FAST® | OptoHiT™ | SupreMOS® | VoltagePlus™ |
| FastvCore™ | OPTOLOGIC® | SyncFET™ | XS™ |
| FETBench™ | OPTOPLANAR® | | |

* Trademarks of System General Corporation, used under license by Fairchild Semiconductor.

DISCLAIMER

FAIRCHILD SEMICONDUCTOR RESERVES THE RIGHT TO MAKE CHANGES WITHOUT FURTHER NOTICE TO ANY PRODUCTS HEREIN TO IMPROVE RELIABILITY, FUNCTION, OR DESIGN. FAIRCHILD DOES NOT ASSUME ANY LIABILITY ARISING OUT OF THE APPLICATION OR USE OF ANY PRODUCT OR CIRCUIT DESCRIBED HEREIN; NEITHER DOES IT CONVEY ANY LICENSE UNDER ITS PATENT RIGHTS, NOR THE RIGHTS OF OTHERS. THESE SPECIFICATIONS DO NOT EXPAND THE TERMS OF FAIRCHILD'S WORLDWIDE TERMS AND CONDITIONS, SPECIFICALLY THE WARRANTY THEREIN, WHICH COVERS THESE PRODUCTS.

LIFE SUPPORT POLICY

FAIRCHILD'S PRODUCTS ARE NOT AUTHORIZED FOR USE AS CRITICAL COMPONENTS IN LIFE SUPPORT DEVICES OR SYSTEMS WITHOUT THE EXPRESS WRITTEN APPROVAL OF FAIRCHILD SEMICONDUCTOR CORPORATION.

As used herein:

1. Life support devices or systems are devices or systems which, (a) are intended for surgical implant into the body or (b) support or sustain life, and (c) whose failure to perform when properly used in accordance with instructions for use provided in the labeling, can be reasonably expected to result in a significant injury of the user.
2. A critical component in any component of a life support, device, or system whose failure to perform can be reasonably expected to cause the failure of the life support device or system, or to affect its safety or effectiveness.

ANTI-COUNTERFEITING POLICY

Fairchild Semiconductor Corporation's Anti-Counterfeiting Policy. Fairchild's Anti-Counterfeiting Policy is also stated on our external website, www.fairchildsemi.com, under Sales Support.

Counterfeiting of semiconductor parts is a growing problem in the industry. All manufacturers of semiconductor products are experiencing counterfeiting of their parts. Customers who inadvertently purchase counterfeit parts experience many problems such as loss of brand reputation, substandard performance, failed applications, and increased cost of production and manufacturing delays. Fairchild is taking strong measures to protect ourselves and our customers from the proliferation of counterfeit parts. Fairchild strongly encourages customers to purchase Fairchild parts either directly from Fairchild or from Authorized Fairchild Distributors who are listed by country on our web page cited above. Products customers buy either from Fairchild directly or from Authorized Fairchild Distributors are genuine parts, have full traceability, meet Fairchild's quality standards for handling and storage and provide access to Fairchild's full range of up-to-date technical and product information. Fairchild and our Authorized Distributors will stand behind all warranties and will appropriately address any warranty issues that may arise. Fairchild will not provide any warranty coverage or other assistance for parts bought from Unauthorized Sources. Fairchild is committed to combat this global problem and encourage our customers to do their part in stopping this practice by buying direct or from authorized distributors.

PRODUCT STATUS DEFINITIONS

Definition of Terms

Datasheet Identification	Product Status	Definition
Advance Information	Formative / In Design	Datasheet contains the design specifications for product development. Specifications may change in any manner without notice.
Preliminary	First Production	Datasheet contains preliminary data; supplementary data will be published at a later date. Fairchild Semiconductor reserves the right to make changes at any time without notice to improve design.
No Identification Needed	Full Production	Datasheet contains final specifications. Fairchild Semiconductor reserves the right to make changes at any time without notice to improve the design.
Obsolete	Not In Production	Datasheet contains specifications on a product that is discontinued by Fairchild Semiconductor. The datasheet is for reference information only.

Rev. I64