

**Features**

- 90% efficiency
- Up to 600mA I<sub>OUT</sub>
- 5V < V<sub>OUT</sub> < 18V
- V<sub>IN</sub> > 2V
- Up to 1.2MHz adjustable frequency
- < 3µA shutdown current
- Adjustable soft-start
- Low battery detection
- Internal thermal protection
- 1.1mm max height 10-pin MSOP package

**Applications**

- 3V to 5V, 12V, and 18V converters
- 5V to 12V and 16V converters
- TFT-LCD
- DSL
- Portable equipment
- Desktop equipment

**Ordering Information**

Part No	Package	Tape & Reel	Outline #
EL7512CY	10-Pin MSOP	-	MDP0043
EL7512CY-T7	10-Pin MSOP	7"	MDP0043
EL7512CY-T13	10-Pin MSOP	13"	MDP0043

**General Description**

The EL7512C is a high frequency, high efficiency step-up DC:DC regulator operated at fixed frequency PWM mode. With an integrated 1A MOSFET, it can deliver up to 600mA output current at up to 90% efficiency. The adjustable switching frequency is up to 1.2MHz, making it ideal for DSL applications.

When shut down, it draws <3µA of current. This feature, along with the minimum starting voltage of 2V, makes it suitable for portable equipment powered by one lithium ion or 3 to 4 NiMH cells.

The EL7512C is available in a 10-pin MSOP package, with maximum height of 1.1mm. With proper external components, the whole converter takes less than 0.25in<sup>2</sup> PCB space.

This device is specified for operation over the full -40°C to +85°C temperature range.

**Typical Application Diagram**

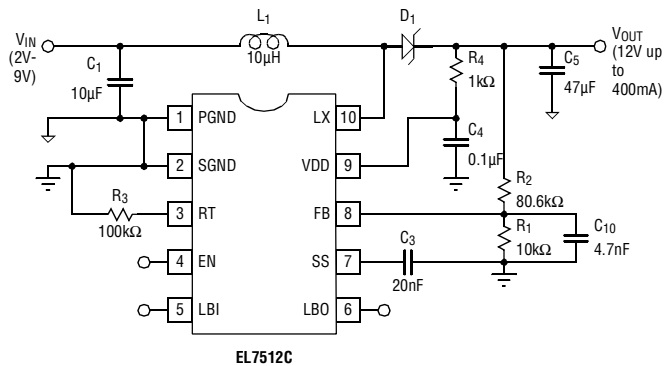

Note: All information contained in this data sheet has been carefully checked and is believed to be accurate as of the date of publication; however, this data sheet cannot be a "controlled document". Current revisions, if any, to these specifications are maintained at the factory and are available upon your request. We recommend checking the revision level before finalization of your design documentation.

# EL7512C

## High Frequency PWM Step-Up Regulator

### Absolute Maximum Ratings (T<sub>A</sub> = 25°C)

Values beyond absolute maximum ratings can cause the device to be prematurely damaged. Absolute maximum ratings are stress ratings only and functional device operation is not implied

EN, LBI, +18V  
LX 20V

V<sub>DD</sub> 12V  
Storage Temperature -65°C to +150°C  
Operating Temperature -40°C to +85°C  
Operating Junction Temperature: 135°C

#### Important Note:

All parameters having Min/Max specifications are guaranteed. Typ values are for information purposes only. Unless otherwise noted, all tests are at the specified temperature and are pulsed tests, therefore: T<sub>J</sub> = T<sub>C</sub> = T<sub>A</sub>

### Electrical Characteristics

V<sub>IN</sub> = 5V, V<sub>OUT</sub> = 12V, I<sub>OUT</sub> = 0mA, R<sub>T</sub> = 100kΩ, T<sub>A</sub> = 25°C unless otherwise specified.

Parameter	Description	Condition	Min	Typ	Max	Unit
IQ1	Quiescent Current - Shut-down	VEN = 0			3	μA
IQ2	Quiescent Current	VEN = 2V		2.5	4	mA
VFB	Feedback Voltage		1.31	1.35	1.39	V
IB	Feedback Input Bias Current				0.10	μA
V <sub>IN</sub>	Input Voltage Range		2			V
D <sub>MAX</sub>	Maximum Duty Cycle		84	90		%
I <sub>LIM</sub>	Current Limit - Max Average Input Current		1000	1250	1500	mA
I <sub>SHDN</sub>	Shut-down Input Bias Current				1	μA
V <sub>LBI</sub>	LBI Threshold Voltage		180	220	250	mV
V <sub>OL-LBO</sub>	LBO Output Low	ILBO = 1mA		0.1	0.2	V
I <sub>LEAK-LBO</sub>	LBO Output Leakage Current	VLBI = 250mV, VLBO = 5V		0.02	1	μA
R <sub>DS-ON</sub>	Switch On Resistance	at 12V output		300		mΩ
I <sub>LEAK-SWITCH</sub>	Switch Leakage Current				1	μA
ΔV <sub>OUT</sub> /ΔV <sub>IN</sub>	Line Regulation	3V < V <sub>IN</sub> < 6V, V <sub>OUT</sub> = 12V, no load			0.15	%/V
ΔV <sub>OUT</sub> /ΔI <sub>OUT</sub>	Load Regulation	I <sub>OUT</sub> < 250mA		0.5		%
F <sub>OSC-MAX</sub>	Maximum Switching Frequency	R <sub>T</sub> = 49.9kΩ		1200		kHz
F <sub>OSC1</sub>	Switching Frequency		530	670	800	kHz
V <sub>HI_EN</sub>	EN Input High Threshold		1.6			V
V <sub>LO_EN</sub>	EN Input Low Threshold				0.5	V

### Pin Descriptions

Pin Number	Pin Name	Pin Function
1	PGND	Power ground; connected to the source of internal N-channel power MOSFET
2	SGND	Signal ground; ground reference for all the control circuitry; needs to have only a single connection to PGND
3	RT	Timing resistor to adjust the oscillation frequency of the converter
4	EN	Chip enable; connects to logic HI (>1.6V) for chip to function
5	LBI	Low battery input; connects to a sensing voltage, or left open if function is not used
6	LBO	Low battery detection output; connected to the open drain of a MOSFET; able to sink 1mA current
7	SS	Soft-start; connects to a capacitor to control the start-up of the converter
8	FB	Voltage feedback input; needs to connect to resistor divider to decide V <sub>O</sub>
9	VDD	Control circuit positive supply
10	LX	Inductor drive pin; connected to the drain of internal N-channel power MOSFET



# EL7512C

High Frequency PWM Step-Up Regulator

## Typical Performance Curves

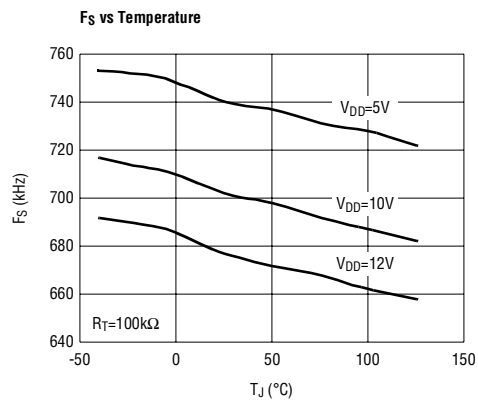
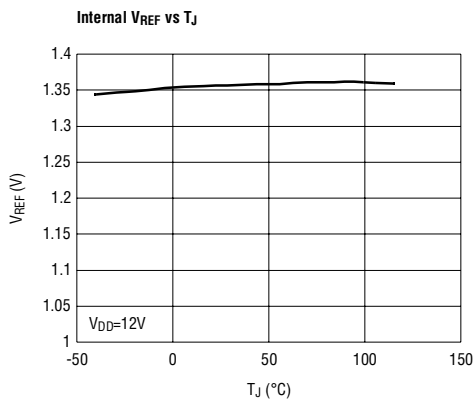
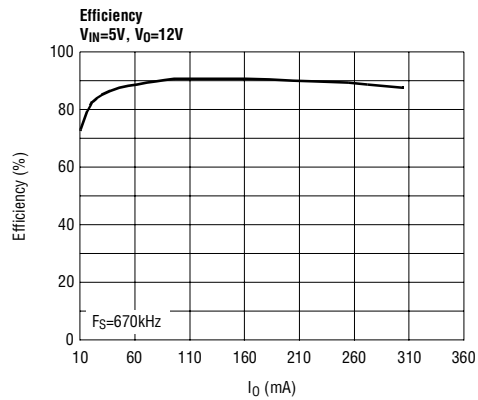
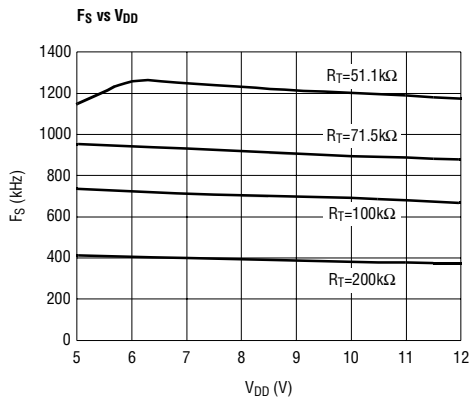
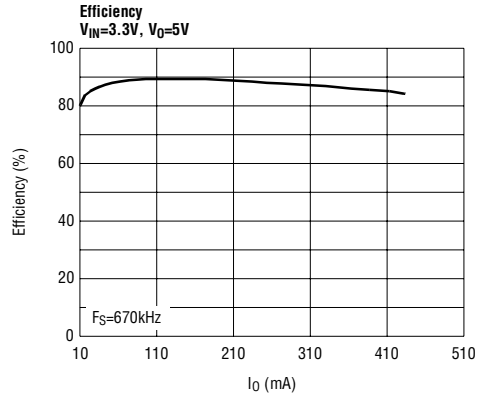
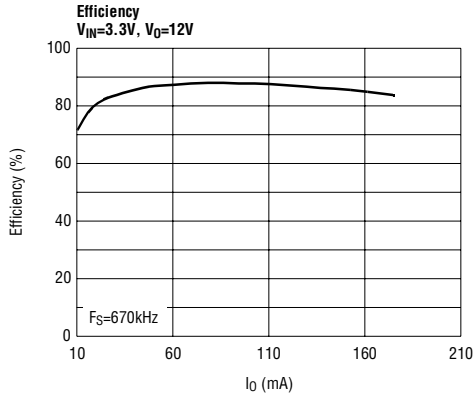

# EL7512C

## High Frequency PWM Step-Up Regulator

EL7512C

### Typical Performance Curves

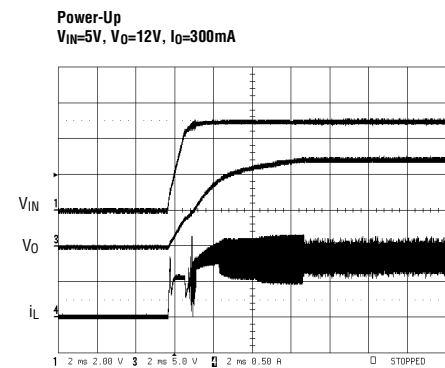
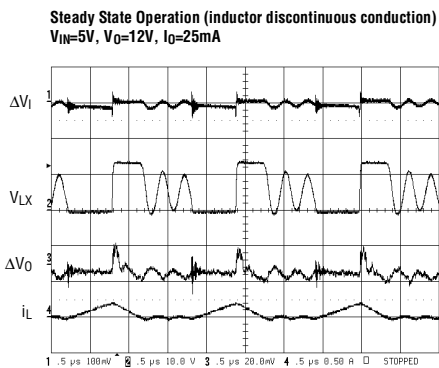
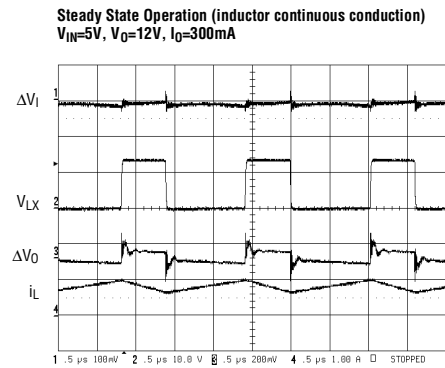
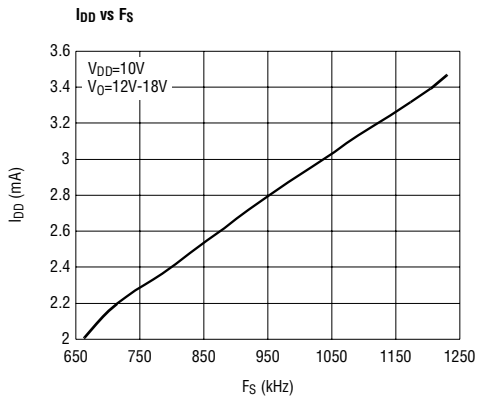
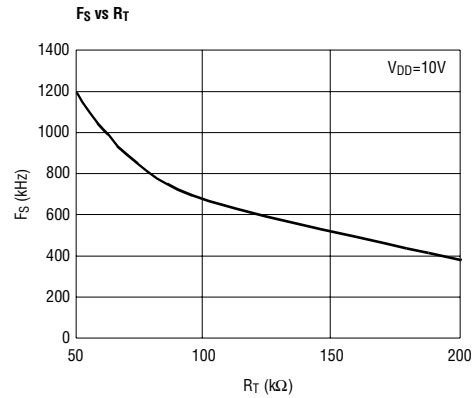
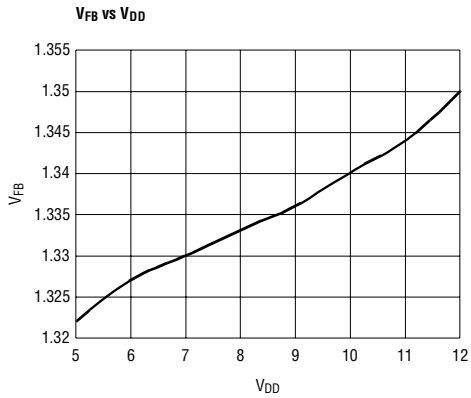

# EL7512C

High Frequency PWM Step-Up Regulator

## Typical Performance Curves

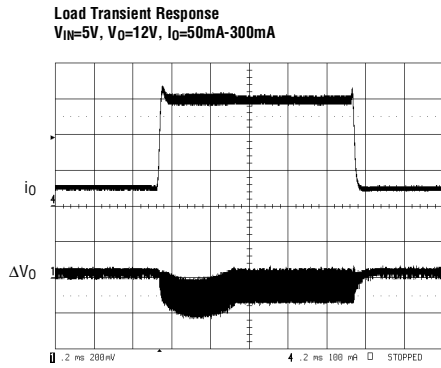

## Applications Information

The EL7512C is a step-up regulator, operated at fixed frequency pulse-width-modulation (PWM) control. The input voltage is 2V-12V and output voltage is 5V-18V. The switching frequency (up to 1.2MHz) is decided by the resistor connected to RT pin.

### Start-Up

After  $V_{DD}$  reaches a threshold of about 2V, the start-up oscillator generates fixed duty-ratio of 0.5-0.7 at a frequency of several hundred kilohertz. This will boost the output voltage.

When  $V_{DD}$  reaches about 3.7V, the PWM comparator takes over the control. The duty ratio will be decided by the multiple-input direct summing comparator, Max\_Duty signal (about 90% duty-ratio), and the Current Limit Comparator, whichever is the smallest.

The soft-start is provided by the current limit comparator. As the internal 12 $\mu$ A current source charges the external CSS, the peak MOSFET current is limited by the voltage on the capacitor. This in turn controls the rising rate of the output voltage.

The regulator goes through the start-up sequence as well after the EN signal is pulled to HI.

### Steady-State Operation

When the output reaches the preset voltage, the regulator operates at steady state. Depending on the input/output conditions and component values, the inductor operates at either continuous-conduction mode or discontinuous-conduction mode.

In the continuous-conduction mode, the inductor current is a triangular waveform and LX voltage a pulse waveform. In the discontinuous-conduction mode, the inductor current is completely dried out before the MOSFET is turned on again. The input voltage source, the inductor, and the MOSFET and output diode parasitic capacitors forms a resonant circuit. Oscillation will occur in this period. This oscillation is normal and will not affect the regulation.

At very low load, the MOSFET will skip pulses sometimes. This is normal.

### Current Limit

The MOSFET current limit is nominally 1.2A and guaranteed 1A. This restricts the maximum output current  $I_{OMAX}$  based on the following formula:

$$I_{OMAX} = \left(1 - \frac{\Delta I_L}{2}\right) \times \frac{V_{IN}}{V_O}$$

where:

$\Delta I_L$  is the inductor peak-to-peak current ripple and is decided by:

$$\Delta I_L = \frac{V_{IN}}{L} \times \frac{D}{F_S}$$

D is the MOSFET turn-on ratio and is decided by:

$$D = \frac{V_O - V_{IN}}{V_O}$$

$F_S$  is the switching frequency.

The following table gives typical values:

### Max Continuous Output Currents

$V_{IN}$ (V)	$V_O$ (V)	L ( $\mu$ H)	$F_S$ (kHz)	$I_{OMAX}$ (mA)
2	5	10	1000	360
2	9	10	1000	190
2	12	10	1000	140
3.3	5	10	1000	600
3.3	9	10	1000	310
3.3	12	10	1000	230
5	9	10	1000	470
5	12	10	1000	340
5	15	10	1000	260
9	12	10	1000	630
9	15	10	1000	470
12	15	10	1000	670
12	18	11	1000	510

### Component Considerations

It is recommended that  $C_{IN}$  is larger than 10 $\mu$ F. Theoretically, the input capacitor has ripple current of  $\Delta I_L$ . Due to high-frequency noise in the circuit, the input current ripple may exceed the theoretical value. Larger capacitor will reduce the ripple further.

# EL7512C

## High Frequency PWM Step-Up Regulator

The inductor has peak and average current decided by:

$$I_{LPK} = I_{LAVG} + \frac{\Delta I_L}{2}$$

$$I_{LAVG} = \frac{I_O}{1-D}$$

The inductor should be chosen to be able to handle this current. Furthermore, due to the fixed internal compensation, it is recommended that maximum inductance of 10 $\mu$ H and 15 $\mu$ H to be used in the 5V and 12V or higher output voltage, respectively.

The output diode has average current of  $I_O$ , and peak current the same as the inductor's peak current. Schottky diode is recommended and it should be able to handle those currents.

Output voltage ripple is the product of peak inductor current times the ESR of output capacitor. Low ESR capacitor is to be used to reduce the output ripple. The minimum output capacitance of 330 $\mu$ F, 47 $\mu$ F, and 33 $\mu$ F is recommended for 5V, 12V, and 16V for 600kHz switching frequency, respectively. For 1MHz switching frequency, 220 $\mu$ F, 33 $\mu$ F, and 22 $\mu$ F capacitor can be used for the output voltages. In addition to the voltage rating, the output capacitor should also be able to handle the rms current is given by:

$$I_{CORMS} = \sqrt{(1-D) \times \left( D + \frac{\Delta I_L^2}{I_{LAVG}^2} \times \frac{1}{12} \right)} \times I_{LAVG}$$

### Output Voltage

An external resistor divider is required to divide the output voltage down to the nominal reference voltage. The current drawn by the resistor network should be limited to maintain the overall converter efficiency. The maximum value of the resistor network is limited by the feedback input bias current and the potential for noise being coupled into the feedback pin. A resistor network less than 300k $\Omega$  is recommended. The boost converter output voltage is determined by the relationship:

$$V_{OUT} = V_{FB} \times \left( 1 + \frac{R_2}{R_1} \right)$$

where  $V_{FB}$  slightly changes with  $V_{DD}$ . The curve is shown in this data sheet.

### RC Filter

The maximum voltage rating for the  $V_{DD}$  pin is 12V and is recommended to be about 10V for maximum efficiency to drive the internal MOSFET. The series resistor  $R_4$  in the RC filter connected to  $V_{DD}$  can be utilized to reduce the voltage. If  $V_O$  is larger than 10V, then:

$$R_4 = \frac{V_O - 10}{I_{DD}}$$

where  $I_{DD}$  is shown in  $I_{DD}$  vs  $F_S$  curve. Otherwise,  $R_4$  can be 10 $\Omega$  to 51 $\Omega$  with  $C_4 = 0.1\mu$ F.

### Thermal Performance

The EL7512C uses a fused-lead package, which has a reduced  $\theta_{JA}$  of 100 $^{\circ}$ C/W on a four-layer board and 115 $^{\circ}$ C/W on a two-layer board. Maximizing copper around the ground pins will improve the thermal performance.

This chip also has internal thermal shut-down set at around 135 $^{\circ}$ C to protect the component.

### Layout Considerations

The layout is very important for the converter to function properly. Power Ground ( $\perp$ ) and Signal Ground ( $\frac{\perp}{-}$ ) should be separated to ensure that the high pulse current in the Power Ground never interferes with the sensitive signals connected to Signal Ground. They should only be connected at one point.

The trace connected to pin 8 (FB) is the most sensitive trace. It needs to be as short as possible and in a "quiet" place, preferably between PGND or SGND traces.

In addition, the bypass capacitor connected to the  $V_{DD}$  pin needs to be as close to the pin as possible.

The heat of the chip is mainly dissipated through the SGND pin. Maximizing the copper area around it is preferable. In addition, a solid ground plane is always helpful for the EMI performance.

The demo board is a good example of layout based on these principles. Please refer to the EL7512C Application Brief for the layout.



# EL7512C

## High Frequency PWM Step-Up Regulator

EL7512C

### Package Outline Drawing

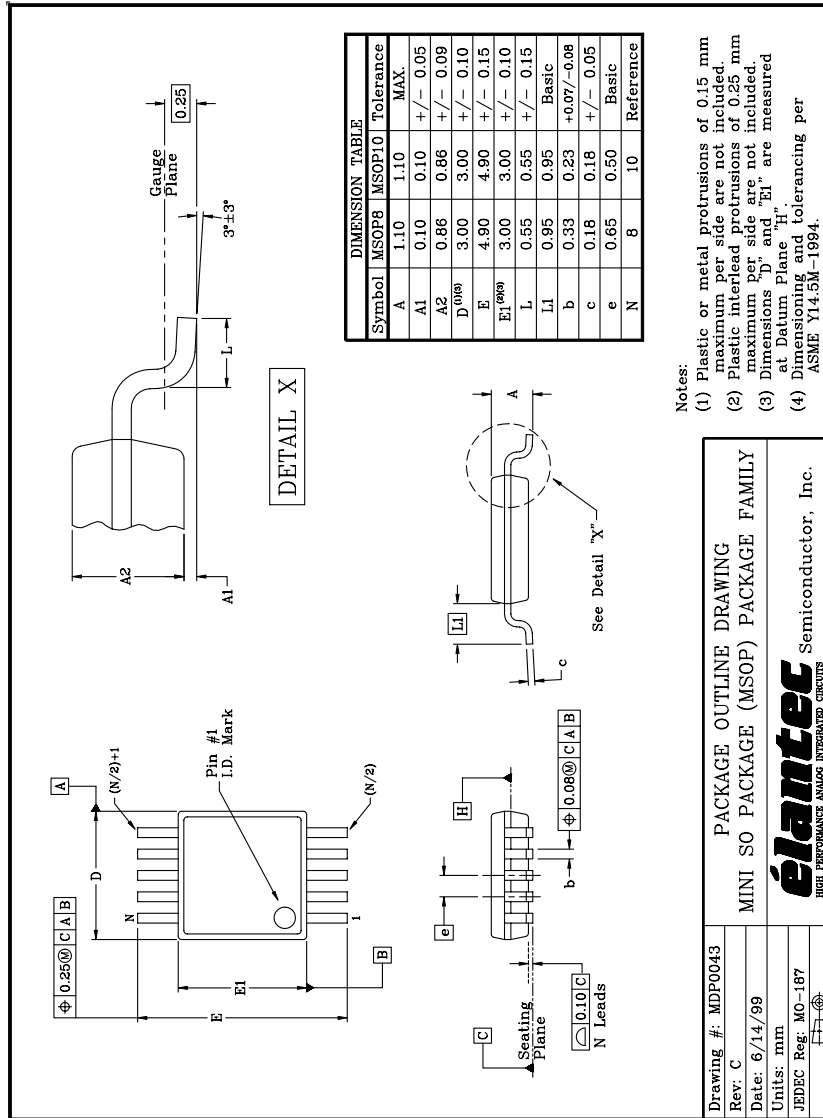

Drawing #: MDP0043  
 Rev: C  
 Date: 6/14/99  
 Units: mm  
 JEDEC Ref: MO-187

PACKAGE OUTLINE DRAWING  
 MINI SO PACKAGE (MSOP) PACKAGE FAMILY

**elantec**  
 HIGH PERFORMANCE ANALOG INTEGRATED CIRCUITS  
 Semiconductor, Inc.

**NOTE:** The package drawing shown here may not be the most recent revision. To verify the latest version, please refer to the Elantec website at: [http://www.elantec.com/pages/package\\_outline.html](http://www.elantec.com/pages/package_outline.html)

# EL7512C

High Frequency PWM Step-Up Regulator

## General Disclaimer

Specifications contained in this data sheet are in effect as of the publication date shown. Elantec, Inc. reserves the right to make changes in the circuitry or specifications contained herein at any time without notice. Elantec, Inc. assumes no responsibility for the use of any circuits described herein and makes no representations that they are free from patent infringement.

**élantec**

HIGH PERFORMANCE ANALOG INTEGRATED CIRCUITS

## Elantec Semiconductor, Inc.

675 Trade Zone Blvd.  
Milpitas, CA 95035  
Telephone: (408) 945-1323  
(888) ELANTEC  
Fax: (408) 945-9305  
European Office: 44-118-977-6020  
Japan Technical Center: 81-45-682-5820

## WARNING - Life Support Policy

Elantec, Inc. products are not authorized for and should not be used within Life Support Systems without the specific written consent of Elantec, Inc. Life Support systems are equipment intended to support or sustain life and whose failure to perform when properly used in accordance with instructions provided can be reasonably expected to result in significant personal injury or death. Users contemplating application of Elantec, Inc. Products in Life Support Systems are requested to contact Elantec, Inc. factory headquarters to establish suitable terms & conditions for these applications. Elantec, Inc.'s warranty is limited to replacement of defective components and does not cover injury to persons or property or other consequential damages.