

# TLC2940 HIGH-PERFORMANCE CMOS VOLTAGE-CONTROLLED OSCILLATOR

SLAS244 – OCTOBER 1999

- **Stable Oscillation Using External Resistor**
- **Lock Frequency Range:**
  - 35 MHz to 75 MHz ( $V_{DD} = 5\text{ V} \pm 0.25\text{ V}$ ,  $T_A = -20^\circ\text{C}$  to  $85^\circ\text{C}$ )
  - 28 MHz to 50 MHz ( $V_{DD} = 3\text{ V} \pm 0.15\text{ V}$ ,  $T_A = -20^\circ\text{C}$  to  $85^\circ\text{C}$ )
- **Operating Free-Air Temperature Range,**  
 $T_A = -20^\circ\text{C}$  to  $85^\circ\text{C}$
- **8-Pin Thin Shrunked Small-Outline Package**

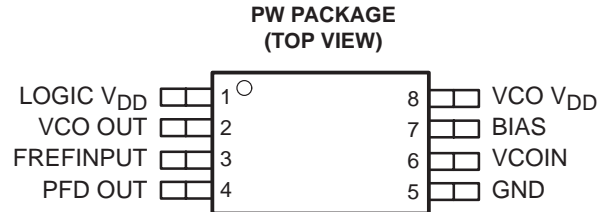

## description

The TLC2940 is a high-performance analog voltage-controlled oscillator (VCO) using Texas Instruments 0.8- $\mu\text{m}$  CMOS process. The VCO oscillating operation can be performed by an external bias resistor connected to the internal oscillation circuitry, and the oscillation frequency range is set by this bias resistor. The lock frequency range for PLL applications is from 35 MHz to 75 MHz (over operating free-air temperature range,  $V_{DD} = 5\text{ V} \pm 5\%$ ), and from 28 MHz to 50 MHz (over operating free-air temperature range,  $V_{DD} = 3\text{ V} \pm 5\%$ ). The stable analog PLL can be configured within these frequency ranges.

The device is available in an 8-pin TSSOP surface-mount package.

The PLL block is configured using a counter, a required LPF, and a phase frequency detector (PFD).

### AVAILABLE OPTIONS

$T_A$	PACKAGE
	TSSOP (PW)
$-20^\circ\text{C}$ to $85^\circ\text{C}$	TLC2940IPW

## functional block diagram

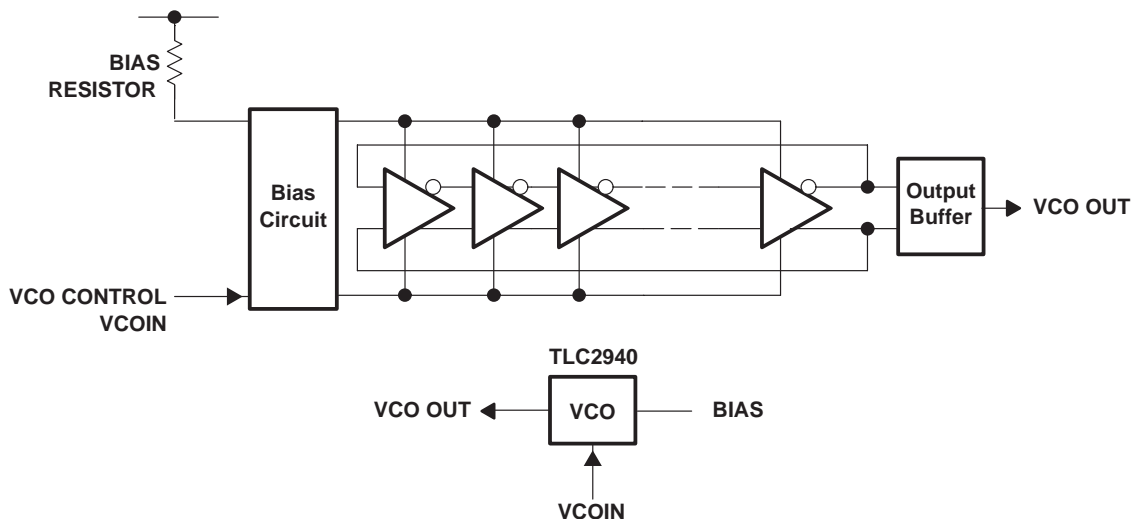

Please be aware that an important notice concerning availability, standard warranty, and use in critical applications of Texas Instruments semiconductor products and disclaimers thereto appears at the end of this data sheet.

PRODUCTION DATA information is current as of publication date. Products conform to specifications per the terms of Texas Instruments standard warranty. Production processing does not necessarily include testing of all parameters.

**TEXAS  
INSTRUMENTS**

POST OFFICE BOX 655303 • DALLAS, TEXAS 75265

Copyright © 1999, Texas Instruments Incorporated

# TLC2940 HIGH-PERFORMANCE CMOS VOLTAGE-CONTROLLED OSCILLATOR

SLAS244 – OCTOBER 1999

## Terminal Functions

TERMINAL NAME	NO.	I/O†	DESCRIPTION
BIAS	7	M	Bias supply terminal for internal VCO. The resistor should be located between $V_{DD}$ and this terminal.
FREFINPUT	3	I	Not used. This terminal should be tied to ground.
GND	5	PS	Ground
LOGIC $V_{DD}$	1	PS	Power supply for the internal logic circuitry (PFD portion, input/output portion). It is recommended that this terminal is separated from the VCO supply voltage terminal.
PFD OUT	4	O	Not used. This terminal should be unconnected (open).
VCOIN	6	I	VCO control voltage input.
VCO OUT	2	O	VCO output. This terminal is tied to a low level at inhibit status.
VCO $V_{DD}$	8	PS	Supply voltage for VCO analog portion.

† I: Input, O: Output, PS: Power supply/GND, M: Others

## detailed description

The TLC2940 is an analog VCO IC that generates a frequency that is a multiple of a reference frequency for a PLL block configuration. Normally, a PLL block is composed of a VCO, a phase frequency detector, counter logic, and a loop filter.

The following is a description for the analog VCO of the TLC2940.

The built-in analog VCO is composed of a ring oscillator portion for oscillation operation and a bias control portion to generate a bias level to supply to the ring oscillator. The oscillation operation is performed by a bias resistor ( $R_{BIAS}$ ) connected between the bias control (pin 7) and the supply voltage (pin 8). The VCO oscillation frequency is determined by this resistor value,  $R_{BIAS}$ , that is, the oscillation frequency decreases as the resistor value increases, and the oscillation frequency increases as the resistor value decreases. The lock frequency range is from 35 MHz to 75 MHz with a  $R_{BIAS}$  of 1.5 k $\Omega$  to 4.3 k $\Omega$  at 5-V operation and from 28 MHz to 50 MHz with a  $R_{BIAS}$  of 1.5 k $\Omega$  to 2.7 k $\Omega$  at 3-V operation over the recommended supply voltage and operating free-air temperature range.

Refer to the curves shown in the typical characteristics section for the lock frequency ranges with varying  $R_{BIAS}$  values.

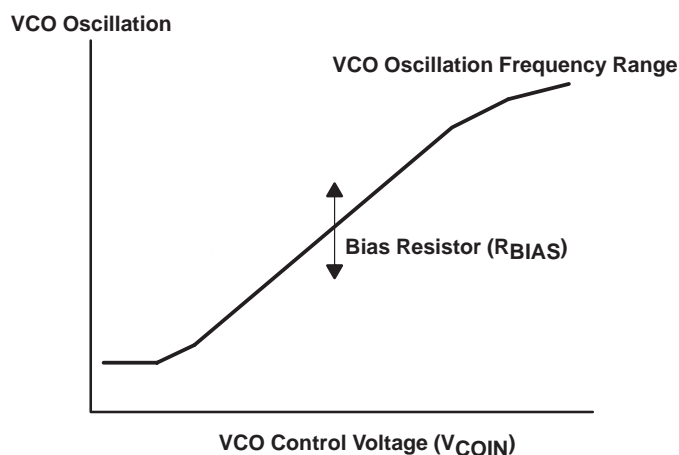

Figure 1. VCO Oscillation Frequency Range Setting

# TLC2940

## HIGH-PERFORMANCE CMOS VOLTAGE-CONTROLLED OSCILLATOR

SLAS244 – OCTOBER 1999

### absolute maximum ratings over operating free-air temperature (unless otherwise noted)†

Supply voltage (any supply), $V_{DD}$ (see Note 1)	7 V
Input voltage range (any input), $V_I$ (see Note 1)	-0.5 V to $V_{DD} + 0.5$ V
Input current (any input), $I_I$	$\pm 20$ mA
Output current (any output), $I_O$	$\pm 20$ mA
Continuous total power dissipation ( $T_A = 25^\circ\text{C}$ or below), $P_D$ (see Note 2)	700 mW
Operating free-air temperature range, $T_A$	-20°C to 85°C
Storage temperature range, $T_{stg}$	-65°C to 150°C
Lead temperature 1,6 mm (1/16 inch) from case for 10 seconds	260°C

† Stresses beyond those listed under “absolute maximum ratings” may cause permanent damage to the device. These are stress ratings only, and functional operation of the device at these or any other conditions beyond those indicated under “recommended operating conditions” is not implied. Exposure to absolute-maximum-rated conditions for extended periods may affect device reliability.

- NOTES: 1. All voltage values are with respect to network GND terminals.  
 2. For operation above 25°C free-air temperature, derate linearly at the rate of 5.6 mW/°C.

### recommended operating conditions

PARAMETER		MIN	NOM	MAX	UNIT	
Supply voltage, $V_{DD}$ (any supply, see Notes 3 and 4)	3-V operation	2.85	3	3.15	V	
	5-V operation	4.75	5	5.25		
Input voltage, $V_I$ (inputs except VCO IN)		0		$V_{DD}$	V	
Output current, $I_O$ (any output)		0		$\pm 2$	mA	
VCO control voltage at VCO IN		1		$V_{DD}-0.5$	V	
Lock frequency	3-V operation	$R_{BIAS} = 1.5\text{ k}\Omega$		42	50	MHz
		$R_{BIAS} = 1.8\text{ k}\Omega$		37	47	
		$R_{BIAS} = 2.2\text{ k}\Omega$		33	45	
		$R_{BIAS} = 2.7\text{ k}\Omega$		28	42	
	5-V operation	$R_{BIAS} = 1.5\text{ k}\Omega$		65	75	
		$R_{BIAS} = 2.4\text{ k}\Omega$		50	65	
		$R_{BIAS} = 3.3\text{ k}\Omega$		43	56	
		$R_{BIAS} = 4.3\text{ k}\Omega$		35	50	
VCO oscillation frequency setting resistor, $R_{BIAS}$	3-V operation	1.5		2.7	k $\Omega$	
	5-V operation	1.5		4.3		
Operating free-air temperature, $T_A$		-20		85	°C	

- NOTES: 3. It is recommended that the logic supply terminal (LOGIC  $V_{DD}$ ) and the VCO supply terminal (VCO  $V_{DD}$ ) should be at the same voltage and separate from each other.  
 4. The bypass capacitor should be located as close as possible to each power supply.  
 5. The FREFINPUT (pin 3) and PFD OUT (pin 4) terminals are input/output terminals preset for logic function respectively. In normal operation, the FREFINPUT should be tied to GND and PDF OUT should be left unconnected (open).



# TLC2940

## HIGH-PERFORMANCE CMOS VOLTAGE-CONTROLLED OSCILLATOR

SLAS244 – OCTOBER 1999

### electrical characteristics over recommended operating free-air temperature range, $V_{DD} = 3\text{ V}$ (unless otherwise noted)

PARAMETER		TEST CONDITIONS	MIN	TYP	MAX	UNIT
$V_{OH}$	High-level output voltage, VCO OUT	$I_{OH} = -2\text{ mA}$	2.4			V
$V_{OL}$	Low-level output voltage, VCO OUT	$I_{OL} = 2\text{ mA}$			0.3	V
$Z_i(\text{VCOIN})$	Input impedance at VCOIN	$\text{VCO IN} = 1/2 V_{DD}$		10		$M\Omega$
$I_{DD}(\text{VCO})$	Supply current	See Note 6		6	10	mA
$f_{osc}$	Oscillation frequency	$R_{BIAS} = 2.4\text{ k}\Omega$ , $\text{VCOIN} = 1/2 V_{DD}$	32	40	48	MHz
$t_r$	Output rise time	$\text{VCOIN} = 0\text{ V}$ , $R_{BIAS} = 2.4\text{ k}\Omega$ , $C_L = 15\text{ pF}$		13		ns
$t_f$	Output fall time	$\text{VCOIN} = 0\text{ V}$ , $R_{BIAS} = 2.4\text{ k}\Omega$ , $C_L = 15\text{ pF}$		6		ns
	Output duty ratio	$R_{BIAS} = 2.4\text{ k}\Omega$ , $\text{VCOIN} = 1/2 V_{DD}$ , See Note 7	40%	44%	60%	
$\alpha(f_{osc})$	Temperature coefficient of oscillation frequency	$\text{VCOIN} = 1/2 V_{DD}$ , $R_{BIAS} = 2.4\text{ k}\Omega$ , $T_A = -20^\circ\text{C}$ to $85^\circ\text{C}$		0.07		$\%/^\circ\text{C}$
$k_{SVS}(f_{osc})$	Supply voltage coefficient of oscillation frequency	$\text{VCOIN} = 1.5\text{ V}$ , $R_{BIAS} = 2.4\text{ k}\Omega$ , $V_{DD} = 2.7\text{ V}$ to $3.3\text{ V}$		0.01		$\%/mV$

NOTES: 6.  $\text{VCOIN} = 1/2 V_{DD}$ ,  $R_{BIAS} = 2.4\text{ k}\Omega$ , current through pin 1 and 8.  
7. The maximum and minimum value of this parameter are not production tested.

### electrical characteristics over recommended operating free-air temperature range, $V_{DD} = 5\text{ V}$ (unless otherwise noted)

PARAMETER		TEST CONDITIONS	MIN	TYP	MAX	UNIT
$V_{OH}$	High-level output voltage, VCO OUT	$I_{OH} = -2\text{ mA}$	4.5			V
$V_{OL}$	Low-level output voltage, VCO OUT	$I_{OL} = 2\text{ mA}$			0.5	V
$Z_i(\text{VCOIN})$	Input impedance at VCOIN	$\text{VCOIN} = 1/2 V_{DD}$		10		$M\Omega$
$I_{DD}(\text{VCO})$	Supply current	See Note 6		16	30	mA
$f_{osc}$	Oscillation frequency	$R_{BIAS} = 2.4\text{ k}\Omega$ , $\text{VCOIN} = 1/2 V_{DD}$	45	65	85	MHz
$t_r$	Output rise time	$\text{VCOIN} = 0\text{ V}$ , $R_{BIAS} = 2.4\text{ k}\Omega$ , $C_L = 15\text{ pF}$		5.8		ns
$t_f$	Output fall time	$\text{VCOIN} = 0\text{ V}$ , $R_{BIAS} = 2.4\text{ k}\Omega$ , $C_L = 15\text{ pF}$		3.2		ns
	Output duty ratio	$R_{BIAS} = 2.4\text{ k}\Omega$ , $\text{VCOIN} = 1/2 V_{DD}$ , See Note 7	40%	46%	60%	
$\alpha(f_{osc})$	Temperature coefficient of oscillation frequency	$\text{VCOIN} = 1/2 V_{DD}$ , $R_{BIAS} = 2.4\text{ k}\Omega$ , $T_A = -20^\circ\text{C}$ to $85^\circ\text{C}$		0.06		$\%/^\circ\text{C}$
$k_{SVS}(f_{osc})$	Supply voltage coefficient of oscillation frequency	$\text{VCOIN} = 2.5\text{ V}$ , $R_{BIAS} = 2.4\text{ k}\Omega$ , $V_{DD} = 4.5\text{ V}$ to $5.5\text{ V}$		0.005		$\%/mV$

NOTES: 6.  $\text{VCOIN} = 1/2 V_{DD}$ ,  $R_{BIAS} = 2.4\text{ k}\Omega$ , current through pin 1 and 8.  
7. The maximum and minimum value of this parameter are not production tested.



PARAMETER MEASUREMENT INFORMATION

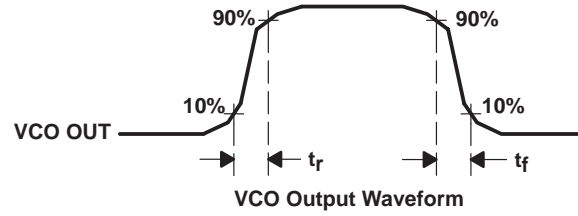
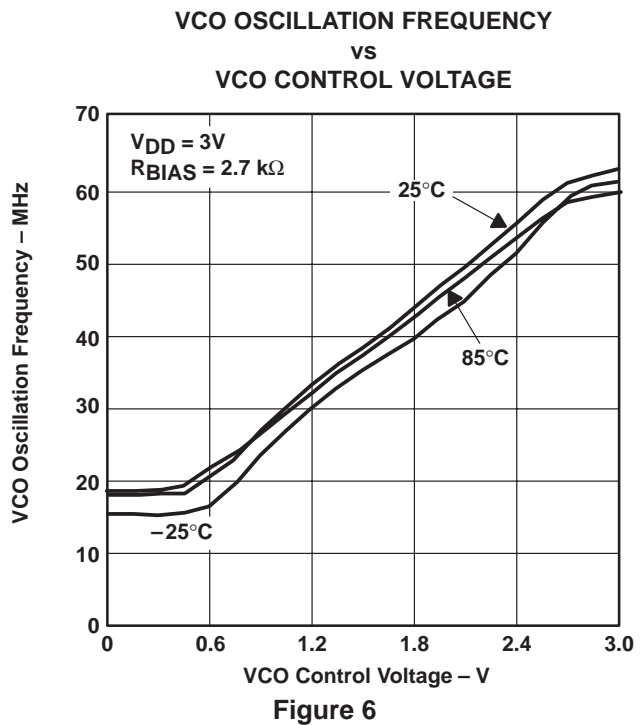
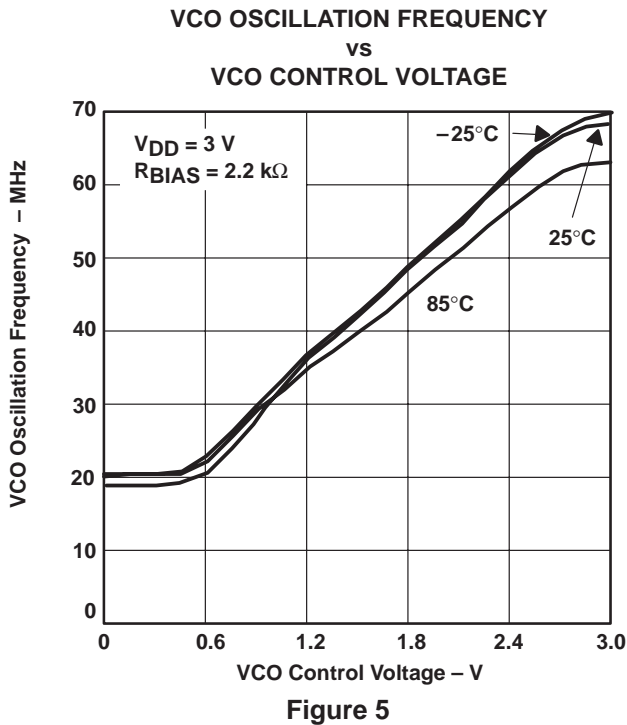
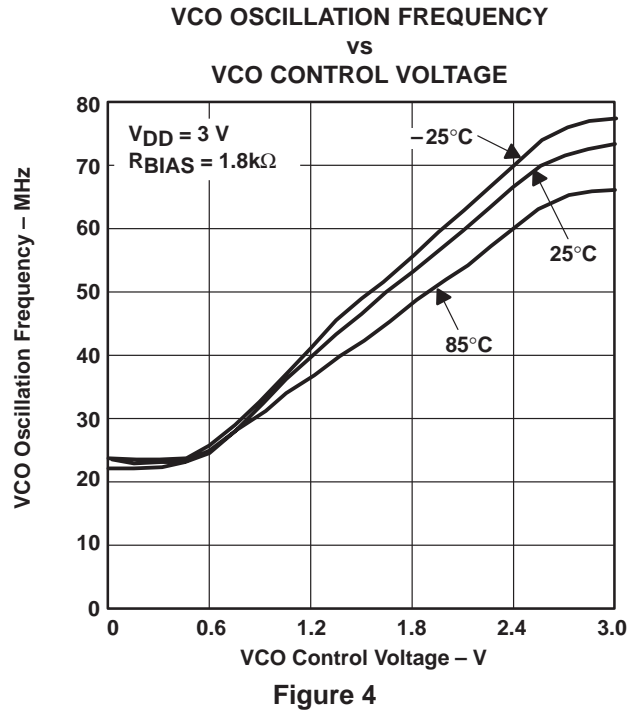
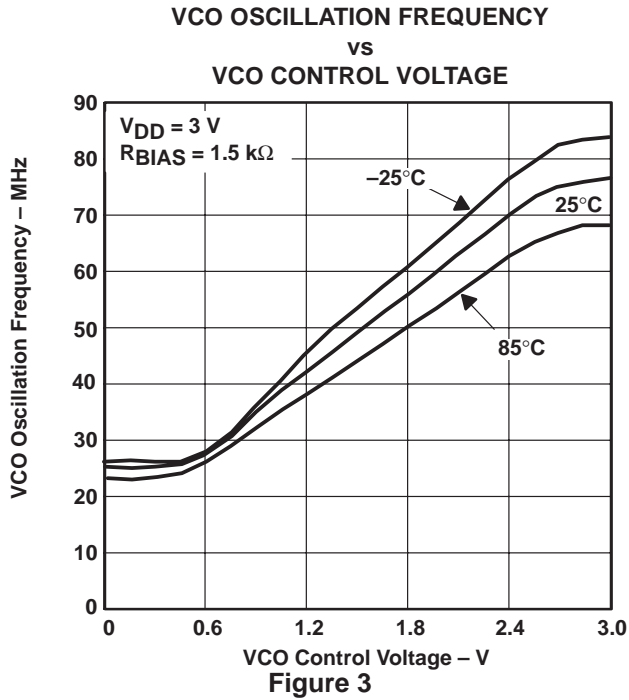

Figure 2. VCO Output Waveform

# TLC2940 HIGH-PERFORMANCE CMOS VOLTAGE-CONTROLLED OSCILLATOR

SLAS244 – OCTOBER 1999

## TYPICAL CHARACTERISTICS



TYPICAL CHARACTERISTICS

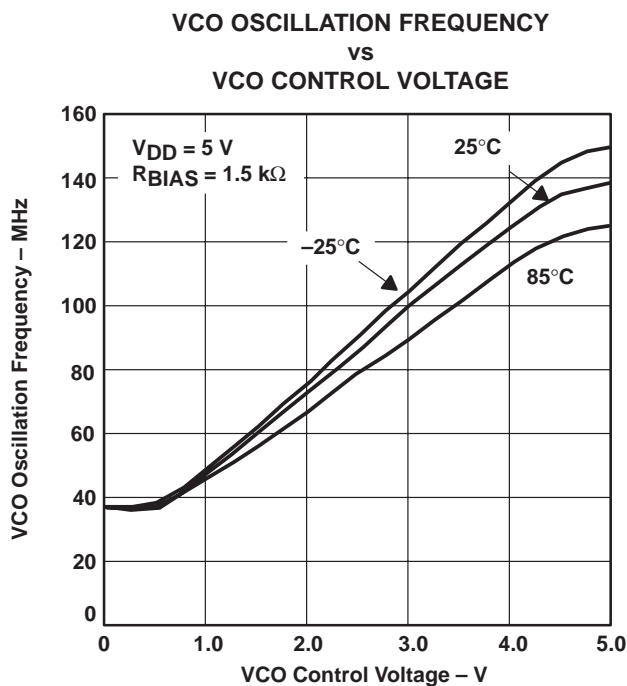

Figure 7

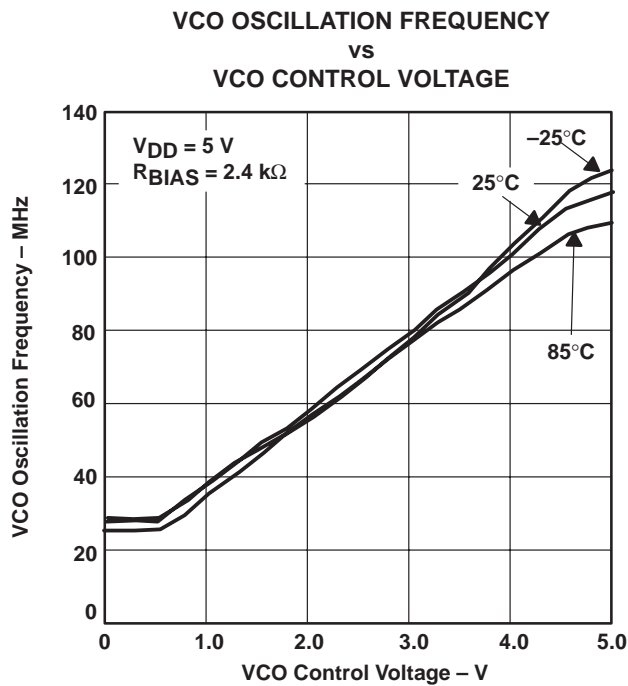

Figure 8

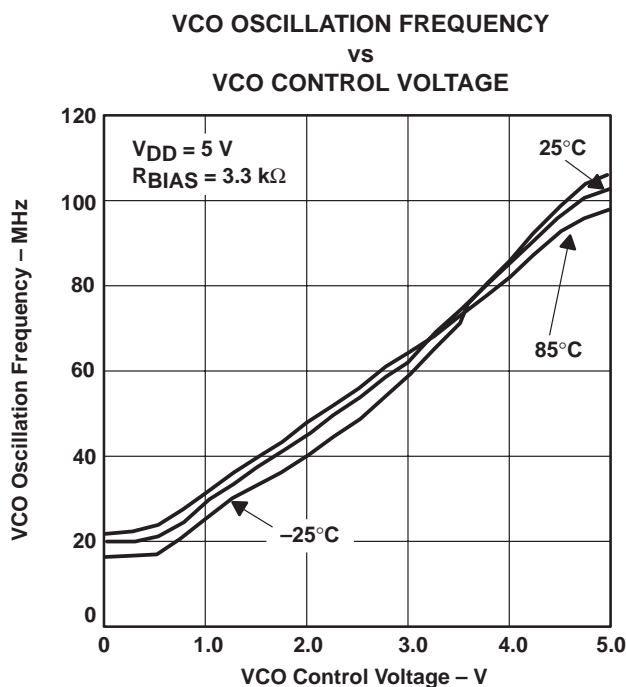

Figure 9

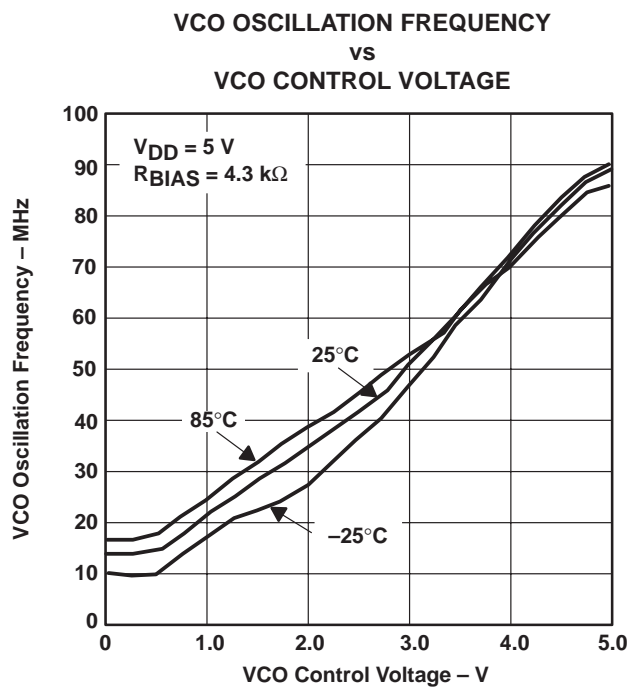

Figure 10

# TLC2940 HIGH-PERFORMANCE CMOS VOLTAGE-CONTROLLED OSCILLATOR

SLAS244 – OCTOBER 1999

## MECHANICAL DATA

PW (R-PDSO-G\*\*)

PLASTIC SMALL-OUTLINE PACKAGE

14 PIN SHOWN

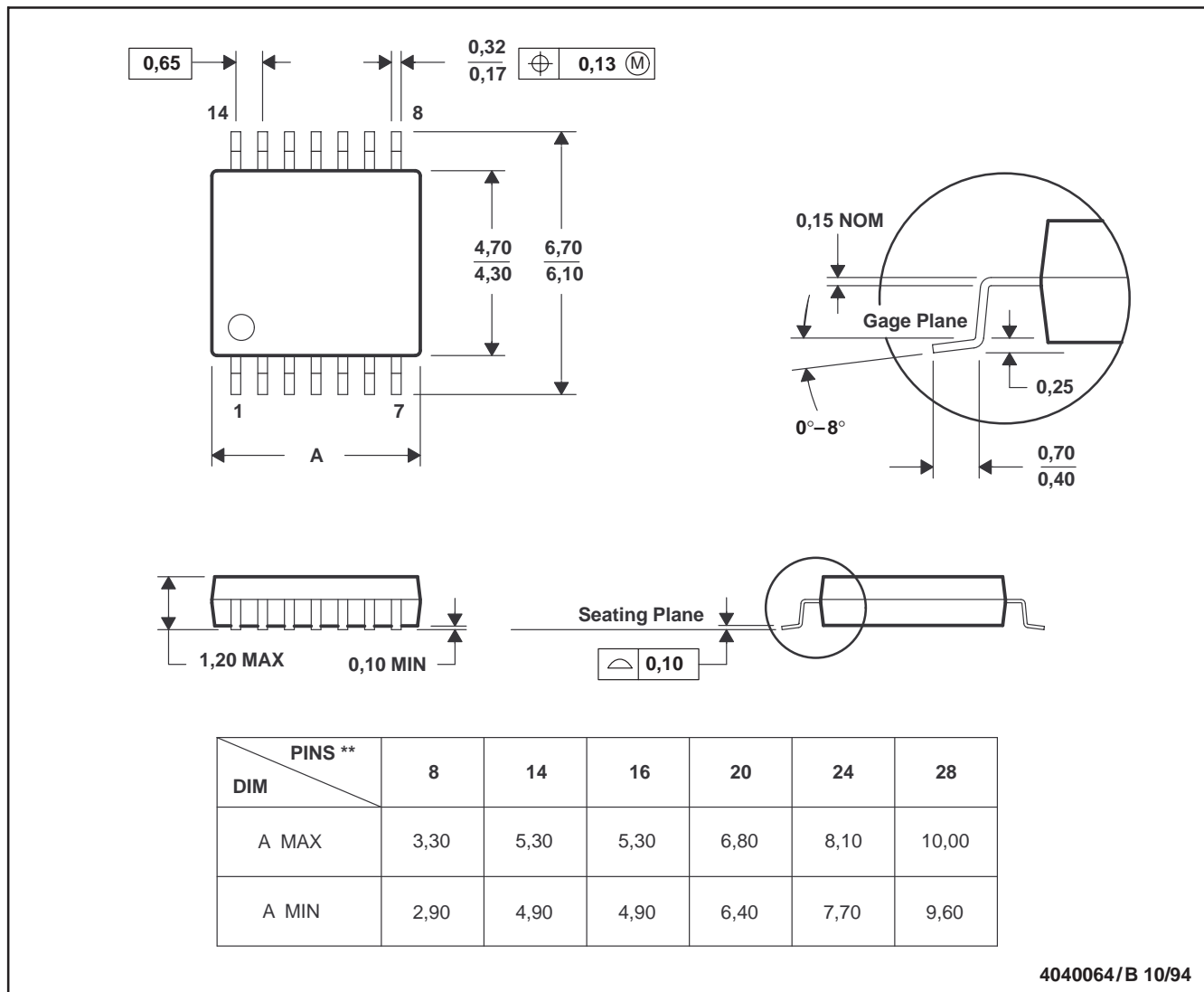

- NOTES: A. All linear dimensions are in millimeters.  
 B. This drawing is subject to change without notice.  
 C. Body dimensions do not include mold flash or protrusion not to exceed 0,15.



**PACKAGING INFORMATION**

Orderable Device	Status <sup>(1)</sup>	Package Type	Package Drawing	Pins	Package Qty	Eco Plan <sup>(2)</sup>	Lead/Ball Finish	MSL Peak Temp <sup>(3)</sup>
TLC2940IPW	OBSOLETE	TSSOP	PW	8		TBD	Call TI	Call TI
TLC2940IPWR	OBSOLETE	TSSOP	PW	8		TBD	Call TI	Call TI

<sup>(1)</sup> The marketing status values are defined as follows:

**ACTIVE:** Product device recommended for new designs.

**LIFEBUY:** TI has announced that the device will be discontinued, and a lifetime-buy period is in effect.

**NRND:** Not recommended for new designs. Device is in production to support existing customers, but TI does not recommend using this part in a new design.

**PREVIEW:** Device has been announced but is not in production. Samples may or may not be available.

**OBSOLETE:** TI has discontinued the production of the device.

<sup>(2)</sup> Eco Plan - The planned eco-friendly classification: Pb-Free (RoHS), Pb-Free (RoHS Exempt), or Green (RoHS & no Sb/Br) - please check <http://www.ti.com/productcontent> for the latest availability information and additional product content details.

**TBD:** The Pb-Free/Green conversion plan has not been defined.

**Pb-Free (RoHS):** TI's terms "Lead-Free" or "Pb-Free" mean semiconductor products that are compatible with the current RoHS requirements for all 6 substances, including the requirement that lead not exceed 0.1% by weight in homogeneous materials. Where designed to be soldered at high temperatures, TI Pb-Free products are suitable for use in specified lead-free processes.

**Pb-Free (RoHS Exempt):** This component has a RoHS exemption for either 1) lead-based flip-chip solder bumps used between the die and package, or 2) lead-based die adhesive used between the die and leadframe. The component is otherwise considered Pb-Free (RoHS compatible) as defined above.

**Green (RoHS & no Sb/Br):** TI defines "Green" to mean Pb-Free (RoHS compatible), and free of Bromine (Br) and Antimony (Sb) based flame retardants (Br or Sb do not exceed 0.1% by weight in homogeneous material)

<sup>(3)</sup> MSL, Peak Temp. -- The Moisture Sensitivity Level rating according to the JEDEC industry standard classifications, and peak solder temperature.

**Important Information and Disclaimer:**The information provided on this page represents TI's knowledge and belief as of the date that it is provided. TI bases its knowledge and belief on information provided by third parties, and makes no representation or warranty as to the accuracy of such information. Efforts are underway to better integrate information from third parties. TI has taken and continues to take reasonable steps to provide representative and accurate information but may not have conducted destructive testing or chemical analysis on incoming materials and chemicals. TI and TI suppliers consider certain information to be proprietary, and thus CAS numbers and other limited information may not be available for release.

In no event shall TI's liability arising out of such information exceed the total purchase price of the TI part(s) at issue in this document sold by TI to Customer on an annual basis.

## IMPORTANT NOTICE

Texas Instruments Incorporated and its subsidiaries (TI) reserve the right to make corrections, modifications, enhancements, improvements, and other changes to its products and services at any time and to discontinue any product or service without notice. Customers should obtain the latest relevant information before placing orders and should verify that such information is current and complete. All products are sold subject to TI's terms and conditions of sale supplied at the time of order acknowledgment.

TI warrants performance of its hardware products to the specifications applicable at the time of sale in accordance with TI's standard warranty. Testing and other quality control techniques are used to the extent TI deems necessary to support this warranty. Except where mandated by government requirements, testing of all parameters of each product is not necessarily performed.

TI assumes no liability for applications assistance or customer product design. Customers are responsible for their products and applications using TI components. To minimize the risks associated with customer products and applications, customers should provide adequate design and operating safeguards.

TI does not warrant or represent that any license, either express or implied, is granted under any TI patent right, copyright, mask work right, or other TI intellectual property right relating to any combination, machine, or process in which TI products or services are used. Information published by TI regarding third-party products or services does not constitute a license from TI to use such products or services or a warranty or endorsement thereof. Use of such information may require a license from a third party under the patents or other intellectual property of the third party, or a license from TI under the patents or other intellectual property of TI.

Reproduction of information in TI data books or data sheets is permissible only if reproduction is without alteration and is accompanied by all associated warranties, conditions, limitations, and notices. Reproduction of this information with alteration is an unfair and deceptive business practice. TI is not responsible or liable for such altered documentation.

Resale of TI products or services with statements different from or beyond the parameters stated by TI for that product or service voids all express and any implied warranties for the associated TI product or service and is an unfair and deceptive business practice. TI is not responsible or liable for any such statements.

Following are URLs where you can obtain information on other Texas Instruments products and application solutions:

<b>Products</b>		<b>Applications</b>	
Amplifiers	<a href="http://amplifier.ti.com">amplifier.ti.com</a>	Audio	<a href="http://www.ti.com/audio">www.ti.com/audio</a>
Data Converters	<a href="http://dataconverter.ti.com">dataconverter.ti.com</a>	Automotive	<a href="http://www.ti.com/automotive">www.ti.com/automotive</a>
DSP	<a href="http://dsp.ti.com">dsp.ti.com</a>	Broadband	<a href="http://www.ti.com/broadband">www.ti.com/broadband</a>
Interface	<a href="http://interface.ti.com">interface.ti.com</a>	Digital Control	<a href="http://www.ti.com/digitalcontrol">www.ti.com/digitalcontrol</a>
Logic	<a href="http://logic.ti.com">logic.ti.com</a>	Military	<a href="http://www.ti.com/military">www.ti.com/military</a>
Power Mgmt	<a href="http://power.ti.com">power.ti.com</a>	Optical Networking	<a href="http://www.ti.com/opticalnetwork">www.ti.com/opticalnetwork</a>
Microcontrollers	<a href="http://microcontroller.ti.com">microcontroller.ti.com</a>	Security	<a href="http://www.ti.com/security">www.ti.com/security</a>
Low Power Wireless	<a href="http://www.ti.com/lpw">www.ti.com/lpw</a>	Telephony	<a href="http://www.ti.com/telephony">www.ti.com/telephony</a>
		Video & Imaging	<a href="http://www.ti.com/video">www.ti.com/video</a>
		Wireless	<a href="http://www.ti.com/wireless">www.ti.com/wireless</a>

Mailing Address: Texas Instruments  
Post Office Box 655303 Dallas, Texas 75265