

National Semiconductor is now part of  
Texas Instruments.

Search <http://www.ti.com/> for the latest technical  
information and details on our current products and services.

# LM4132

## SOT-23 Precision Low Dropout Voltage Reference

### General Description

The LM4132 family of precision voltage references performs comparable to the best laser-trimmed bipolar references, but in cost effective CMOS technology. The key to this breakthrough is the use of EEPROM registers for correction of curvature, tempco, and accuracy on a CMOS bandgap architecture that allows package level programming to overcome assembly shift. The shifts in voltage accuracy and tempco during assembly of die into plastic packages limit the accuracy of references trimmed with laser techniques.

Unlike other LDO references, the LM4132 is capable of delivering up to 20mA and does not require an output capacitor or buffer amplifier. These advantages and the SOT23 packaging are important for space-critical applications.

Series references provide lower power consumption than shunt references, since they do not have to idle the maximum possible load current under no load conditions. This advantage, the low quiescent current (60 $\mu$ A), and the low dropout voltage (400mV) make the LM4132 ideal for battery-powered solutions.

The LM4132 is available in five grades (A, B, C, D and E) for greater flexibility. The best grade devices (A) have an initial accuracy of 0.05% with guaranteed temperature coefficient of 10ppm/ $^{\circ}$ C or less, while the lowest grade parts (E) have an initial accuracy of 0.5% and a tempco of 30ppm/ $^{\circ}$ C.

### Features

- Output initial voltage accuracy 0.05%
- Low temperature coefficient 10ppm/ $^{\circ}$ C
- Low Supply Current, 60 $\mu$ A
- Enable pin allowing a 3 $\mu$ A shutdown mode
- 20mA output current
- Voltage options 1.8V, 2.048V, 2.5V, 3.0V, 3.3V, 4.096V
- Custom voltage options available (1.8V to 4.096V)
- $V_{IN}$  range of  $V_{REF} + 400\text{mV}$  to 5.5V @ 10mA
- Stable with low ESR ceramic capacitors
- SOT23-5 Package

### Applications

- Instrumentation & Process Control
- Test Equipment
- Data Acquisition Systems
- Base Stations
- Servo Systems
- Portable, Battery Powered Equipment
- Automotive & Industrial
- Precision Regulators
- Battery Chargers
- Communications
- Medical Equipment

### Typical Application Circuit

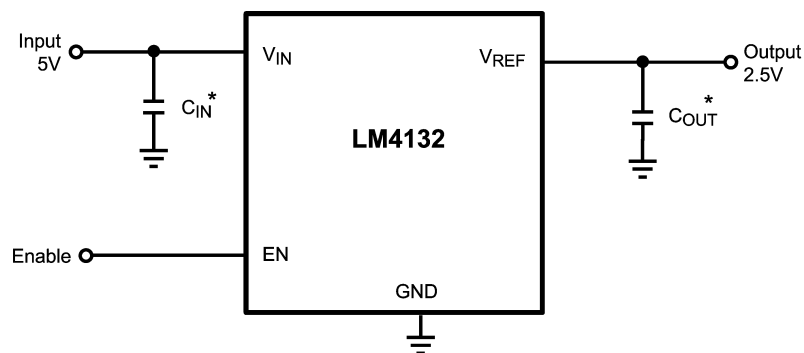

\*Note: The capacitor  $C_{IN}$  is required and the capacitor  $C_{OUT}$  is optional.

20151301

## Connection Diagram

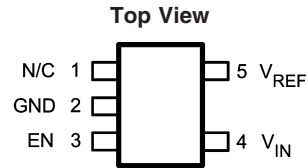

20151302  
**SOT23-5 Package**  
**NS Package Number MF05A**

## Ordering Information

Input Output Voltage Accuracy at 25°C And Temperature Coefficient	LM4132 Supplied as 1000 units, Tape and Reel	LM4132 Supplied as 3000 units, Tape and Reel	Part Marking
0.05%, 10 ppm/°C max (A grade)	LM4132AMF-1.8	LM4132AMFX-1.8	R4AA
	LM4132AMF-2.0	LM4132AMFX-2.0	R4BA
	LM4132AMF-2.5	LM4132AMFX-2.5	R4CA
	LM4132AMF-3.0	LM4132AMFX-3.0	R4DA
	LM4132AMF-3.3	LM4132AMFX-3.3	R4EA
	LM4132AMF-4.1	LM4132AMFX-4.1	R4FA
0.1%, 20 ppm/°C max (B grade)	LM4132BMF-1.8	LM4132BMFX-1.8	R4AB
	LM4132BMF-2.0	LM4132BMFX-2.0	R4BB
	LM4132BMF-2.5	LM4132BMFX-2.5	R4CB
	LM4132BMF-3.0	LM4132BMFX-3.0	R4DB
	LM4132BMF-3.3	LM4132BMFX-3.3	R4EB
	LM4132BMF-4.1	LM4132BMFX-4.1	R4FB
0.2%, 20 ppm/°C max (C grade)	LM4132CMF-1.8	LM4132CMFX-1.8	R4AC
	LM4132CMF-2.0	LM4132CMFX-2.0	R4BC
	LM4132CMF-2.5	LM4132CMFX-2.5	R4CC
	LM4132CMF-3.0	LM4132CMFX-3.0	R4DC
	LM4132CMF-3.3	LM4132CMFX-3.3	R4EC
	LM4132CMF-4.1	LM4132CMFX-4.1	R4FC
0.4%, 20 ppm/°C max (D grade)	LM4132DMF-1.8	LM4132DMFX-1.8	R4AD
	LM4132DMF-2.0	LM4132DMFX-2.0	R4BD
	LM4132DMF-2.5	LM4132DMFX-2.5	R4CD
	LM4132DMF-3.0	LM4132DMFX-3.0	R4DD
	LM4132DMF-3.3	LM4132DMFX-3.3	R4ED
	LM4132DMF-4.1	LM4132DMFX-4.1	R4FD
0.5%, 30 ppm/°C max (E grade)	LM4132EMF-1.8	LM4132EMFX-1.8	R4AE
	LM4132EMF-2.0	LM4132EMFX-2.0	R4BE
	LM4132EMF-2.5	LM4132EMFX-2.5	R4CE
	LM4132EMF-3.0	LM4132EMFX-3.0	R4DE
	LM4132EMF-3.3	LM4132EMFX-3.3	R4EE
	LM4132EMF-4.1	LM4132EMFX-4.1	R4FE

## Pin Descriptions

Pin #	Name	Function
1	N/C	No connect pin, leave floating
2	GND	Ground
3	EN	Enable pin
4	V <sub>IN</sub>	Input supply
5	V <sub>REF</sub>	Reference output

**Absolute Maximum Ratings** (Note 1)

If Military/Aerospace specified devices are required, please contact the National Semiconductor Sales Office/Distributors for availability and specifications.

Maximum Voltage on any input	-0.3 to 6V
Output short circuit duration	Indefinite
Power Dissipation ( $T_A = 25^\circ\text{C}$ ) (Note 2)	350mW
Storage Temperature Range	$-65^\circ\text{C}$ to $150^\circ\text{C}$

Lead Temperature (soldering, 10sec)	$260^\circ\text{C}$
Vapor Phase (60 sec)	$215^\circ\text{C}$
Infrared (15sec)	$220^\circ\text{C}$
ESD Susceptibility (Note 3)	
Human Body Model	2kV

**Operating Ratings**

Maximum Input Supply Voltage	5.5V
Maximum Enable Input Voltage	$V_{IN}$
Maximum Load Current	20mA
Junction Temperature Range ( $T_J$ )	$-40^\circ\text{C}$ to $+125^\circ\text{C}$

**Electrical Characteristics**

**LM4132-1.8 ( $V_{OUT} = 1.8\text{V}$ )** Limits in standard type are for  $T_J = 25^\circ\text{C}$  only, and limits in boldface type apply over the junction temperature ( $T_J$ ) range of  $-40^\circ\text{C}$  to  $+125^\circ\text{C}$  unless otherwise specified. Minimum and Maximum limits are guaranteed through test, design, or statistical correlation. Typical values represent the most likely parametric norm at  $T_J = 25^\circ\text{C}$ , and are provided for reference purposes only. Unless otherwise specified  $V_{IN} = 5\text{V}$  and  $I_{LOAD} = 0$

Symbol	Parameter	Conditions	Min (Note 4)	Typ (Note 5)	Max (Note 4)	Unit
$V_{REF}$	Output Voltage Initial Accuracy					
	LM4132A-1.8	(A Grade - 0.05%)	-0.05		0.05	%
	LM4132B-1.8	(B Grade - 0.1%)	-0.1		0.1	
	LM4132C-1.8	(C Grade - 0.2%)	-0.2		0.2	
	LM4132D-1.8	(D Grade - 0.4%)	-0.4		0.4	
$TCV_{REF} / ^\circ\text{C}$ (Note 6)	Temperature Coefficient					
	LM4132A-1.8	$0^\circ\text{C} \leq T_J \leq +85^\circ\text{C}$			<b>10</b>	ppm / $^\circ\text{C}$
		$-40^\circ\text{C} \leq T_J \leq +125^\circ\text{C}$			<b>20</b>	
	LM4132B-1.8	$-40^\circ\text{C} \leq T_J \leq +125^\circ\text{C}$			<b>20</b>	
	LM4132C-1.8				<b>20</b>	
LM4132D-1.8				<b>20</b>		
LM4132E-1.8				<b>30</b>		
$I_Q$	Supply Current			60	<b>100</b>	$\mu\text{A}$
$I_{Q\_SD}$	Supply Current in Shutdown	EN = 0V		3	<b>7</b>	$\mu\text{A}$
$\Delta V_{REF}/\Delta V_{IN}$	Line Regulation	$V_{REF} + 400\text{mV} \leq V_{IN} \leq 5.5\text{V}$		30		ppm / V
$\Delta V_{REF}/\Delta I_{LOAD}$	Load Regulation	$0\text{mA} \leq I_{LOAD} \leq 20\text{mA}$		25	<b>120</b>	ppm / mA
$\Delta V_{REF}$	Long Term Stability (Note 7)	1000 Hrs		50		ppm
	Thermal Hysteresis (Note 8)	$-40^\circ\text{C} \leq T_J \leq +125^\circ\text{C}$		75		
$V_{IN} - V_{REF}$	Dropout Voltage (Note 9)	$I_{LOAD} = 10\text{mA}$		230	<b>400</b>	mV
$V_N$	Output Noise Voltage	0.1 Hz to 10 Hz		170		$\mu\text{V}_{PP}$
$I_{SC}$	Short Circuit Current				<b>75</b>	mA
$V_{IL}$	Enable Pin Maximum Low Input Level				<b>35</b>	$\%V_{IN}$
$V_{IH}$	Enable Pin Minimum High Input Level		<b>65</b>			$\%V_{IN}$

## Electrical Characteristics

### LM4132-2.0 ( $V_{OUT} = 2.048V$ )

Limits in standard type are for  $T_J = 25^\circ C$  only, and limits in boldface type apply over the junction temperature ( $T_J$ ) range of  $-40^\circ C$  to  $+125^\circ C$  unless otherwise specified. Minimum and Maximum limits are guaranteed through test, design, or statistical correlation. Typical values represent the most likely parametric norm at  $T_J = 25^\circ C$ , and are provided for reference purposes only. Unless otherwise specified  $V_{IN} = 5V$  and  $I_{LOAD} = 0$

Symbol	Parameter	Conditions	Min (Note 4)	Typ (Note 5)	Max (Note 4)	Unit
$V_{REF}$	Output Voltage Initial Accuracy					
	LM4132A-2.0	(A Grade - 0.05%)	-0.05		0.05	%
	LM4132B-2.0	(B Grade - 0.1%)	-0.1		0.1	
	LM4132C-2.0	(C Grade - 0.2%)	-0.2		0.2	
	LM4132D-2.0	(D Grade - 0.4%)	-0.4		0.4	
	LM4132E-2.0	(E Grade - 0.5%)	-0.5		0.5	
$TCV_{REF} / ^\circ C$ (Note 6)	Temperature Coefficient					
	LM4132A-2.0	$0^\circ C \leq T_J \leq +85^\circ C$			<b>10</b>	ppm / $^\circ C$
		$-40^\circ C \leq T_J \leq +125^\circ C$			<b>20</b>	
	LM4132B-2.0	$-40^\circ C \leq T_J \leq +125^\circ C$			<b>20</b>	
	LM4132C-2.0				<b>20</b>	
	LM4132D-2.0				<b>20</b>	
LM4132E-2.0				<b>30</b>		
$I_Q$	Supply Current			60	<b>100</b>	$\mu A$
$I_{Q\_SD}$	Supply Current in Shutdown	EN = 0V		3	<b>7</b>	$\mu A$
$\Delta V_{REF}/\Delta V_{IN}$	Line Regulation	$V_{REF} + 400mV \leq V_{IN} \leq 5.5V$		30		ppm / V
$\Delta V_{REF}/\Delta I_{LOAD}$	Load Regulation	$0mA \leq I_{LOAD} \leq 20mA$		25	<b>120</b>	ppm / mA
$\Delta V_{REF}$	Long Term Stability (Note 7)	1000 Hrs		50		ppm
	Thermal Hysteresis (Note 8)	$-40^\circ C \leq T_J \leq +125^\circ C$		75		
$V_{IN} - V_{REF}$	Dropout Voltage (Note 9)	$I_{LOAD} = 10mA$		175	<b>400</b>	mV
$V_N$	Output Noise Voltage	0.1 Hz to 10 Hz		190		$\mu V_{PP}$
$I_{SC}$	Short Circuit Current				<b>75</b>	mA
$V_{IL}$	Enable Pin Maximum Low Input Level				<b>35</b>	$\%V_{IN}$
$V_{IH}$	Enable Pin Minimum High Input Level		<b>65</b>			$\%V_{IN}$

## Electrical Characteristics

**LM4132-2.5 (V<sub>OUT</sub> = 2.5V)** Limits in standard type are for T<sub>J</sub> = 25°C only, and limits in boldface type apply over the junction temperature (T<sub>J</sub>) range of -40°C to +125°C unless otherwise specified. Minimum and Maximum limits are guaranteed through test, design, or statistical correlation. Typical values represent the most likely parametric norm at T<sub>J</sub> = 25°C, and are provided for reference purposes only. Unless otherwise specified V<sub>IN</sub> = 5V and I<sub>LOAD</sub> = 0

Symbol	Parameter	Conditions	Min (Note 4)	Typ (Note 5)	Max (Note 4)	Unit
V <sub>REF</sub>	Output Voltage Initial Accuracy					
	LM4132A-2.5	(A Grade - 0.05%)	-0.05		0.05	%
	LM4132B-2.5	(B Grade - 0.1%)	-0.1		0.1	
	LM4132C-2.5	(C Grade - 0.2%)	-0.2		0.2	
	LM4132D-2.5	(D Grade - 0.4%)	-0.4		0.4	
LM4132E-2.5	(E Grade - 0.5%)	-0.5		0.5		
TCV <sub>REF</sub> / °C (Note 6)	Temperature Coefficient					
	LM4132A-2.5	0°C ≤ T <sub>J</sub> ≤ +85°C			<b>10</b>	ppm / °C
		-40°C ≤ T <sub>J</sub> ≤ +125°C			<b>20</b>	
	LM4132B-2.5	-40°C ≤ T <sub>J</sub> ≤ +125°C			<b>20</b>	
	LM4132C-2.5				<b>20</b>	
	LM4132D-2.5				<b>20</b>	
LM4132E-2.5				<b>30</b>		
I <sub>Q</sub>	Supply Current			60	<b>100</b>	μA
I <sub>Q,SD</sub>	Supply Current in Shutdown	EN = 0V		3	<b>7</b>	μA
ΔV <sub>REF</sub> /ΔV <sub>IN</sub>	Line Regulation	V <sub>REF</sub> + 400mV ≤ V <sub>IN</sub> ≤ 5.5V		50		ppm / V
ΔV <sub>REF</sub> /ΔI <sub>LOAD</sub>	Load Regulation	0mA ≤ I <sub>LOAD</sub> ≤ 20mA		25	<b>120</b>	ppm / mA
ΔV <sub>REF</sub>	Long Term Stability (Note 7)	1000 Hrs		50		ppm
	Thermal Hysteresis (Note 8)	-40°C ≤ T <sub>J</sub> ≤ +125°C		75		
V <sub>IN</sub> - V <sub>REF</sub>	Dropout Voltage (Note 9)	I <sub>LOAD</sub> = 10mA		175	<b>400</b>	mV
V <sub>N</sub>	Output Noise Voltage	0.1 Hz to 10 Hz		240		μV <sub>PP</sub>
I <sub>SC</sub>	Short Circuit Current				<b>75</b>	mA
V <sub>IL</sub>	Enable Pin Maximum Low Input Level				<b>35</b>	%V <sub>IN</sub>
V <sub>IH</sub>	Enable Pin Minimum High Input Level		<b>65</b>			%V <sub>IN</sub>

## Electrical Characteristics

### LM4132-3.0 ( $V_{OUT} = 3.0V$ )

Limits in standard type are for  $T_J = 25^\circ C$  only, and limits in boldface type apply over the junction temperature ( $T_J$ ) range of  $-40^\circ C$  to  $+125^\circ C$  unless otherwise specified. Minimum and Maximum limits are guaranteed through test, design, or statistical correlation. Typical values represent the most likely parametric norm at  $T_J = 25^\circ C$ , and are provided for reference purposes only. Unless otherwise specified  $V_{IN} = 5V$  and  $I_{LOAD} = 0$

Symbol	Parameter	Conditions	Min (Note 4)	Typ (Note 5)	Max (Note 4)	Unit
$V_{REF}$	Output Voltage Initial Accuracy					
	LM4132A-3.0	(A Grade - 0.05%)	-0.05		0.05	%
	LM4132B-3.0	(B Grade - 0.1%)	-0.1		0.1	
	LM4132C-3.0	(C Grade - 0.2%)	-0.2		0.2	
	LM4132D-3.0	(D Grade - 0.4%)	-0.4		0.4	
	LM4132E-3.0	(E Grade - 0.5%)	-0.5		0.5	
$TCV_{REF} / ^\circ C$ (Note 6)	Temperature Coefficient					
	LM4132A-3.0	$0^\circ C \leq T_J \leq +85^\circ C$			<b>10</b>	ppm / $^\circ C$
		$-40^\circ C \leq T_J \leq +125^\circ C$			<b>20</b>	
	LM4132B-3.0	$-40^\circ C \leq T_J \leq +125^\circ C$			<b>20</b>	
	LM4132C-3.0				<b>20</b>	
	LM4132D-3.0				<b>20</b>	
LM4132E-3.0				<b>30</b>		
$I_Q$	Supply Current			60	<b>100</b>	$\mu A$
$I_{Q\_SD}$	Supply Current in Shutdown	EN = 0V		3	<b>7</b>	$\mu A$
$\Delta V_{REF}/\Delta V_{IN}$	Line Regulation	$V_{REF} + 400mV \leq V_{IN} \leq 5.5V$		70		ppm / V
$\Delta V_{REF}/\Delta I_{LOAD}$	Load Regulation	$0mA \leq I_{LOAD} \leq 20mA$		25	<b>120</b>	ppm / mA
$\Delta V_{REF}$	Long Term Stability (Note 7)	1000 Hrs		50		ppm
	Thermal Hysteresis (Note 8)	$-40^\circ C \leq T_J \leq +125^\circ C$		75		
$V_{IN} - V_{REF}$	Dropout Voltage (Note 9)	$I_{LOAD} = 10mA$		175	<b>400</b>	mV
$V_N$	Output Noise Voltage	0.1 Hz to 10 Hz		285		$\mu V_{PP}$
$I_{SC}$	Short Circuit Current				<b>75</b>	mA
$V_{IL}$	Enable Pin Maximum Low Input Level				<b>35</b>	$\%V_{IN}$
$V_{IH}$	Enable Pin Minimum High Input Level		<b>65</b>			$\%V_{IN}$

## Electrical Characteristics

**LM4132-3.3 ( $V_{OUT} = 3.3V$ )** Limits in standard type are for  $T_J = 25^\circ C$  only, and limits in boldface type apply over the junction temperature ( $T_J$ ) range of  $-40^\circ C$  to  $+125^\circ C$  unless otherwise specified. Minimum and Maximum limits are guaranteed through test, design, or statistical correlation. Typical values represent the most likely parametric norm at  $T_J = 25^\circ C$ , and are provided for reference purposes only. Unless otherwise specified  $V_{IN} = 5V$  and  $I_{LOAD} = 0$

Symbol	Parameter	Conditions	Min (Note 4)	Typ (Note 5)	Max (Note 4)	Unit
$V_{REF}$	Output Voltage Initial Accuracy					
	LM4132A-3.3	(A Grade - 0.05%)	-0.05		0.05	%
	LM4132B-3.3	(B Grade - 0.1%)	-0.1		0.1	
	LM4132C-3.3	(C Grade - 0.2%)	-0.2		0.2	
	LM4132D-3.3	(D Grade - 0.4%)	-0.4		0.4	
LM4132E-3.3	(E Grade - 0.5%)	-0.5		0.5		
$TCV_{REF} / ^\circ C$ (Note 6)	Temperature Coefficient					
	LM4132A-3.3	$0^\circ C \leq T_J \leq +85^\circ C$			<b>10</b>	ppm / $^\circ C$
		$-40^\circ C \leq T_J \leq +125^\circ C$			<b>20</b>	
	LM4132B-3.3	$-40^\circ C \leq T_J \leq +125^\circ C$			<b>20</b>	
	LM4132C-3.3				<b>20</b>	
	LM4132D-3.3				<b>20</b>	
LM4132E-3.3				<b>30</b>		
$I_Q$	Supply Current			60	<b>100</b>	$\mu A$
$I_{Q\_SD}$	Supply Current in Shutdown	EN = 0V		3	<b>7</b>	$\mu A$
$\Delta V_{REF}/\Delta V_{IN}$	Line Regulation	$V_{REF} + 400mV \leq V_{IN} \leq 5.5V$		85		ppm / V
$\Delta V_{REF}/\Delta I_{LOAD}$	Load Regulation	$0mA \leq I_{LOAD} \leq 20mA$		25	<b>120</b>	ppm / mA
$\Delta V_{REF}$	Long Term Stability (Note 7)	1000 Hrs		50		ppm
	Thermal Hysteresis (Note 8)	$-40^\circ C \leq T_J \leq +125^\circ C$		75		
$V_{IN} - V_{REF}$	Dropout Voltage (Note 9)	$I_{LOAD} = 10mA$		175	<b>400</b>	mV
$V_N$	Output Noise Voltage	0.1 Hz to 10 Hz		310		$\mu V_{PP}$
$I_{SC}$	Short Circuit Current				<b>75</b>	mA
$V_{IL}$	Enable Pin Maximum Low Input Level				<b>35</b>	$\%V_{IN}$
$V_{IH}$	Enable Pin Minimum High Input Level		<b>65</b>			$\%V_{IN}$



## Electrical Characteristics

### LM4132-4.1 ( $V_{OUT} = 4.096V$ )

Limits in standard type are for  $T_J = 25^\circ C$  only, and limits in boldface type apply over the junction temperature ( $T_J$ ) range of  $-40^\circ C$  to  $+125^\circ C$  unless otherwise specified. Minimum and Maximum limits are guaranteed through test, design, or statistical correlation. Typical values represent the most likely parametric norm at  $T_J = 25^\circ C$ , and are provided for reference purposes only. Unless otherwise specified  $V_{IN} = 5V$  and  $I_{LOAD} = 0$

Symbol	Parameter	Conditions	Min (Note 4)	Typ (Note 5)	Max (Note 4)	Unit
$V_{REF}$	Output Voltage Initial Accuracy					
	LM4132A-4.1	(A Grade - 0.05%)	-0.05		0.05	%
	LM4132B-4.1	(B Grade - 0.1%)	-0.1		0.1	
	LM4132C-4.1	(C Grade - 0.2%)	-0.2		0.2	
	LM4132D-4.1	(D Grade - 0.4%)	-0.4		0.4	
	LM4132E-4.1	(E Grade - 0.5%)	-0.5		0.5	
$TCV_{REF} / ^\circ C$ (Note 6)	Temperature Coefficient					
	LM4132A-4.1	$0^\circ C \leq T_J \leq +85^\circ C$			<b>10</b>	ppm / $^\circ C$
		$-40^\circ C \leq T_J \leq +125^\circ C$			<b>20</b>	
	LM4132B-4.1	$-40^\circ C \leq T_J \leq +125^\circ C$			<b>20</b>	
	LM4132C-4.1				<b>20</b>	
	LM4132D-4.1				<b>20</b>	
LM4132E-4.1				<b>30</b>		
$I_Q$	Supply Current			60	<b>100</b>	$\mu A$
$I_{Q\_SD}$	Supply Current in Shutdown	EN = 0V		3	<b>7</b>	$\mu A$
$\Delta V_{REF} / \Delta V_{IN}$	Line Regulation	$V_{REF} + 400mV \leq V_{IN} \leq 5.5V$		100		ppm / V
$\Delta V_{REF} / \Delta I_{LOAD}$	Load Regulation	$0mA \leq I_{LOAD} \leq 20mA$		25	<b>120</b>	ppm / mA
$\Delta V_{REF}$	Long Term Stability (Note 7)	1000 Hrs		50		ppm
	Thermal Hysteresis (Note 8)	$-40^\circ C \leq T_J \leq +125^\circ C$		75		
$V_{IN} - V_{REF}$	Dropout Voltage (Note 9)	$I_{LOAD} = 10mA$		175	<b>400</b>	mV
$V_N$	Output Noise Voltage	0.1 Hz to 10 Hz		350		$\mu V_{PP}$
$I_{SC}$	Short Circuit Current				<b>75</b>	mA
$V_{IL}$	Enable Pin Maximum Low Input Level				<b>35</b>	$\%V_{IN}$
$V_{IH}$	Enable Pin Minimum High Input Level		<b>65</b>			$\%V_{IN}$

**Note 1:** Absolute Maximum Ratings indicate limits beyond which damage may occur to the device. Operating Ratings indicate conditions for which the device is intended to be functional, but do not guarantee specific performance limits. For guaranteed specifications, see Electrical Characteristics.

**Note 2:** Without PCB copper enhancements. The maximum power dissipation must be de-rated at elevated temperatures and is limited by  $T_{JMAX}$  (maximum junction temperature),  $\theta_{J-A}$  (junction to ambient thermal resistance) and  $T_A$  (ambient temperature). The maximum power dissipation at any temperature is:  $P_{DISSMAX} = (T_{JMAX} - T_A) / \theta_{J-A}$  up to the value listed in the Absolute Maximum Ratings.  $\theta_{J-A}$  for SOT23-5 package is  $220^\circ C/W$ ,  $T_{JMAX} = 125^\circ C$ .

**Note 3:** The human body model is a 100 pF capacitor discharged through a 1.5 k $\Omega$  resistor into each pin.

**Note 4:** Limits are 100% production tested at 25 $^\circ C$ . Limits over the operating temperature range are guaranteed through correlation using Statistical Quality Control.

**Note 5:** Typical numbers are at 25 $^\circ C$  and represent the most likely parametric norm.

**Note 6:** Temperature coefficient is measured by the "Box" method; i.e., the maximum  $\Delta V_{REF}$  is divided by the maximum  $\Delta T$ .

**Note 7:** Long term stability is  $V_{REF}$  @25 $^\circ C$  measured during 1000 hrs.

**Note 8:** Thermal hysteresis is defined as the change in +25 $^\circ C$  output voltage before and after cycling the device from (-40 $^\circ C$  to 125 $^\circ C$ ).

**Note 9:** Dropout voltage is defined as the minimum input to output differential at which the output voltage drops by 0.5% below the value measured with a 5V input.

# Typical Performance Characteristics for 1.8V

Output Voltage vs Temperature

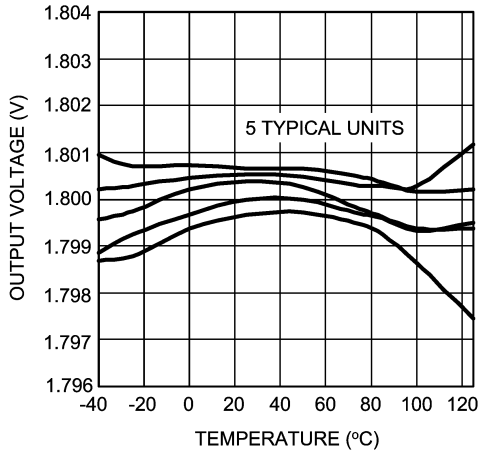

20151364

Load Regulation

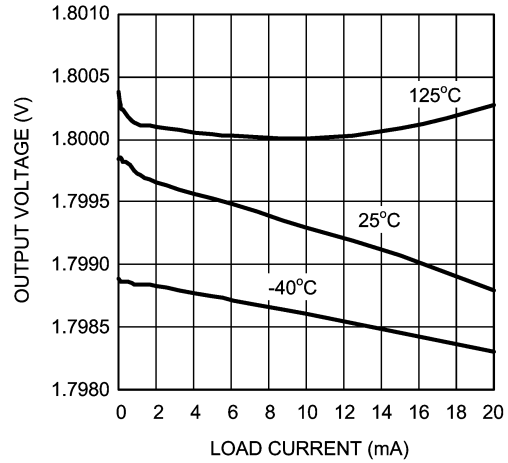

20151367

Line Regulation

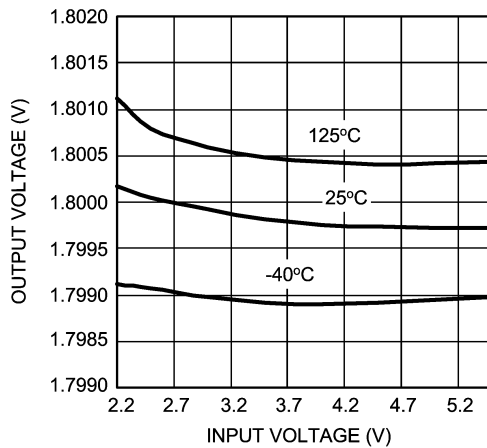

20151368

0.1-10Hz Noise Spectrum

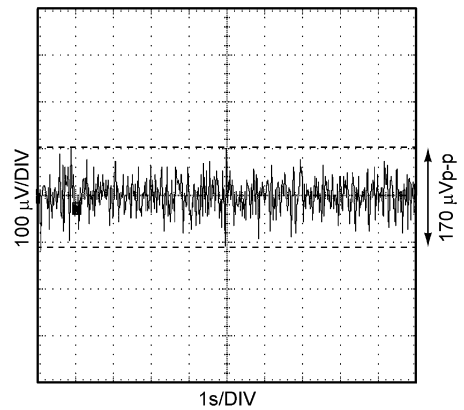

20151379

Output Voltage Noise Spectrum

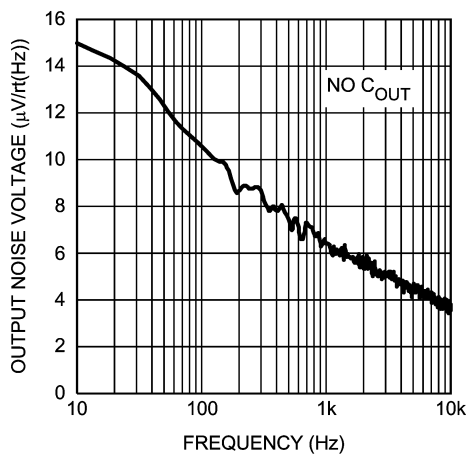

20151373

Power Supply Rejection vs Frequency

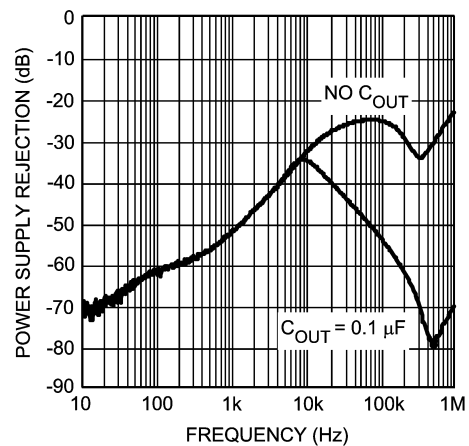

20151376

# Typical Performance Characteristics for 2.048V

Output Voltage vs Temperature

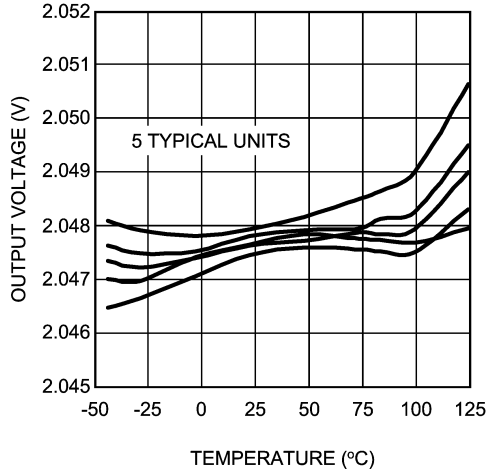

20151303

Load Regulation

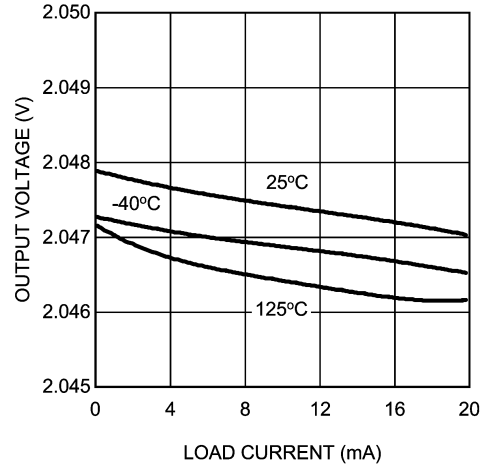

20151304

Line Regulation

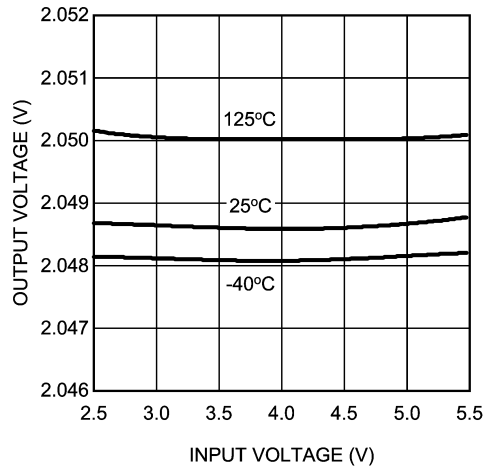

20151309

0.1 - 10 Hz Noise

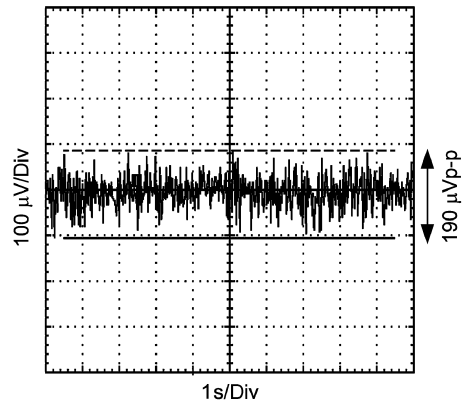

20151314

Output Voltage Noise Spectrum

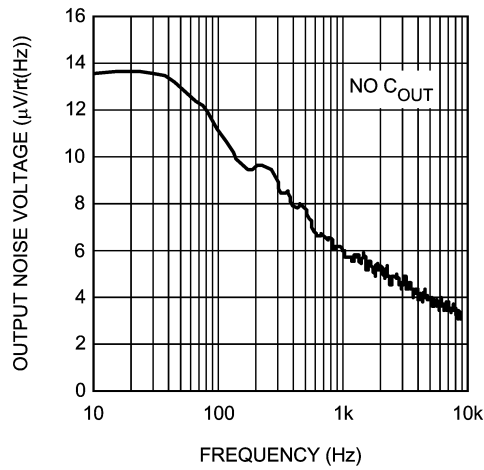

20151340

Power Supply Rejection vs Frequency

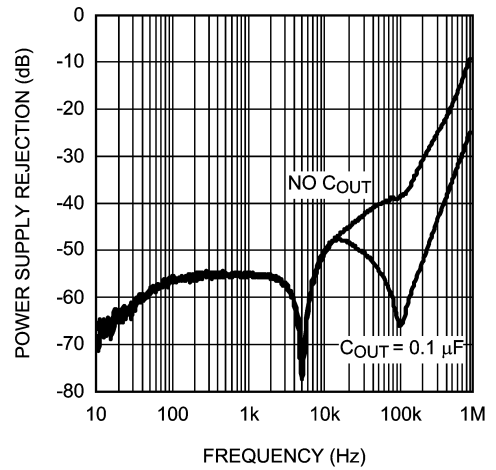

20151315

# Typical Performance Characteristics for 2.5V

Output Voltage vs Temperature

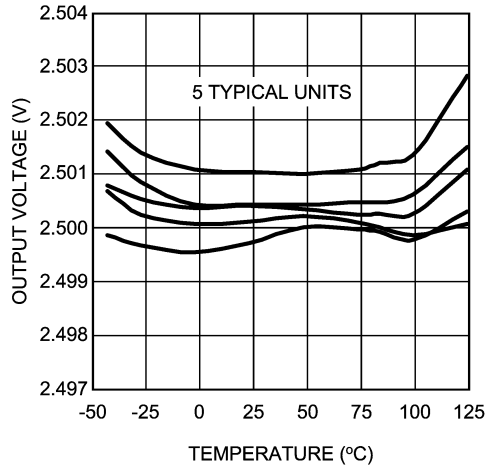

20151354

Load Regulation

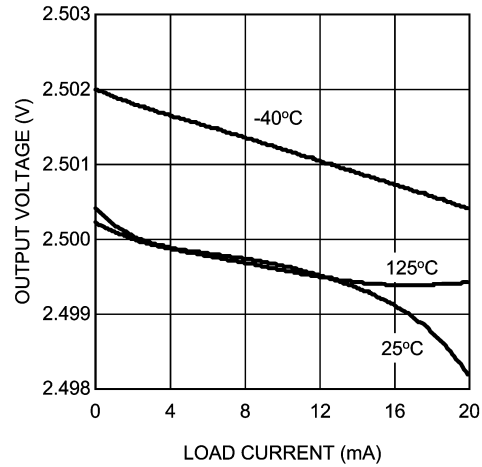

20151355

Line Regulation

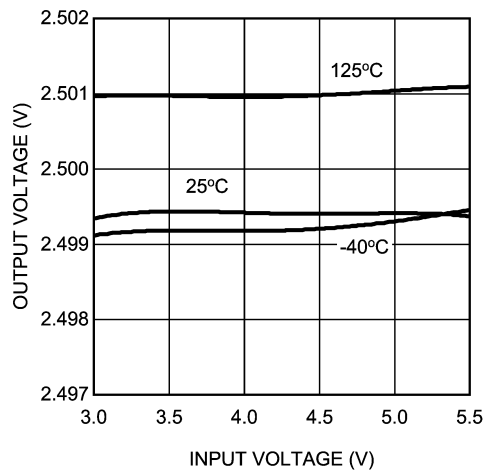

20151356

0.1 - 10 Hz Noise

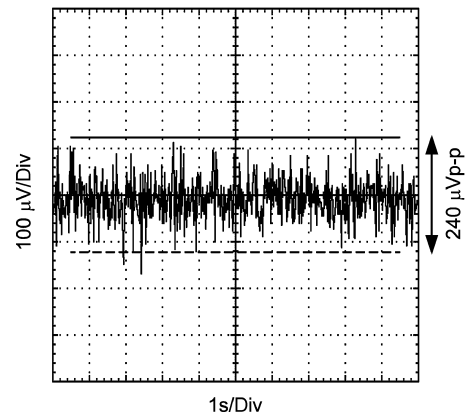

20151321

Output Voltage Noise Spectrum

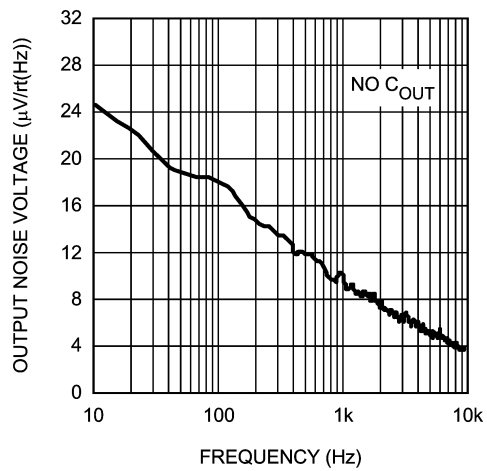

20151357

Power Supply Rejection vs Frequency

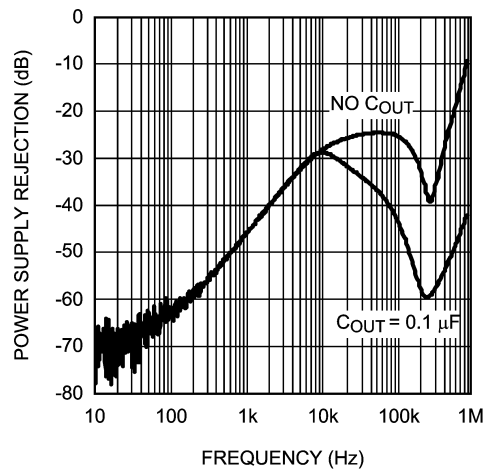

20151358

# Typical Performance Characteristics for 3.0V

Output Voltage vs Temperature

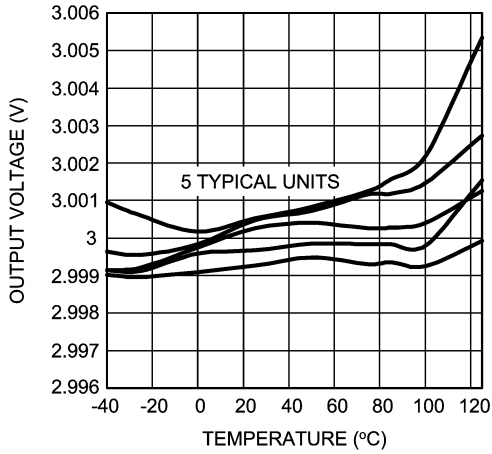

20151365

Load Regulation

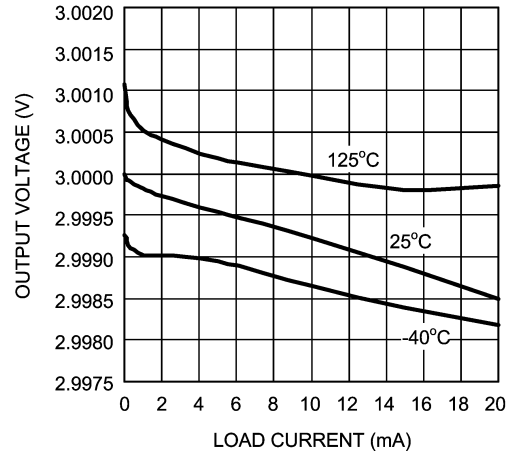

20151369

Line Regulation

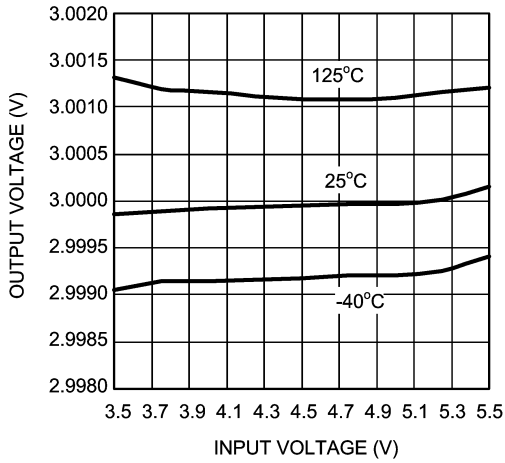

20151370

0.1-10 Hz Noise Spectrum

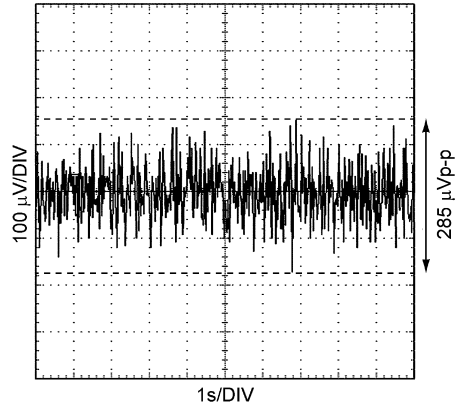

20151380

Output Voltage Noise Spectrum

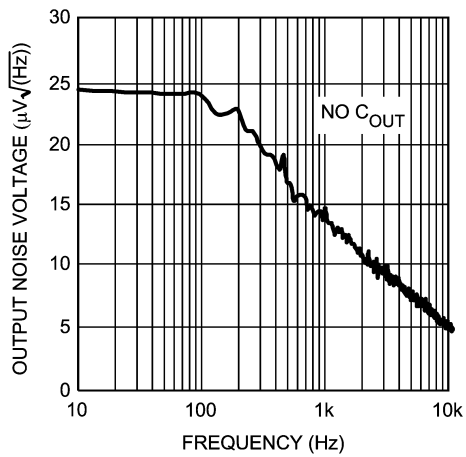

20151374

Power Supply Rejection vs Frequency

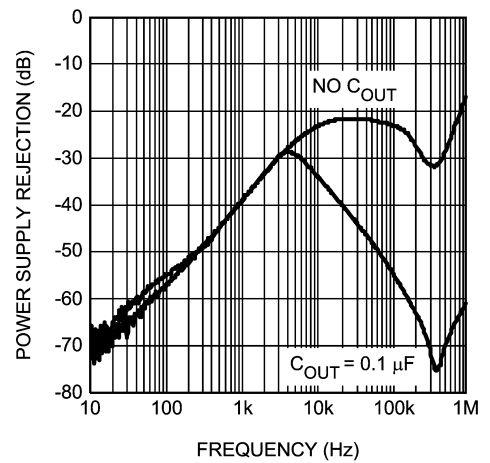

20151377

# Typical Performance Characteristics for 3.3V

Output Voltage vs Temperature

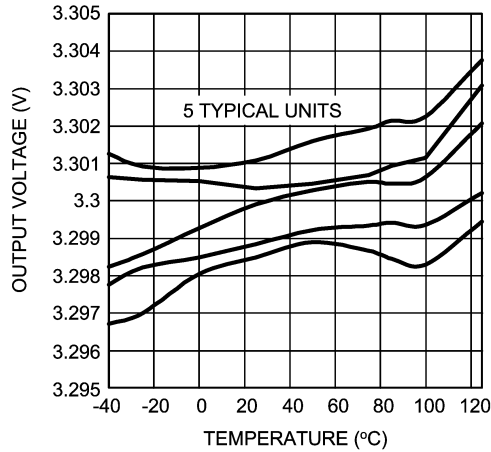

20151366

Load Regulation

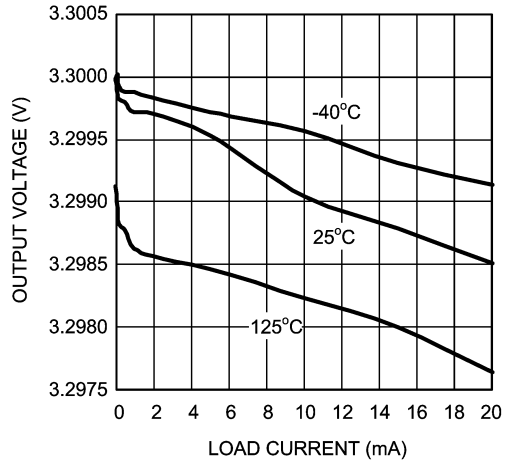

20151371

Line Regulation

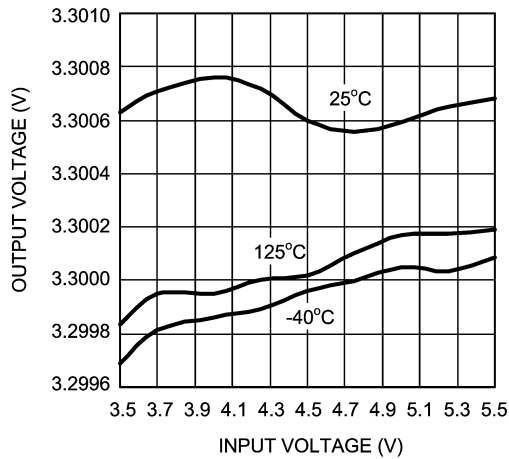

20151372

0.1-10 Hz Noise Spectrum

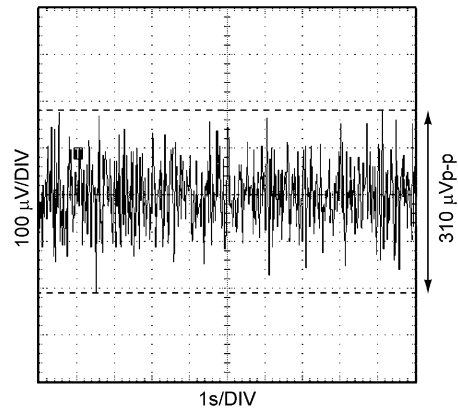

20151381

Output Voltage Noise Spectrum

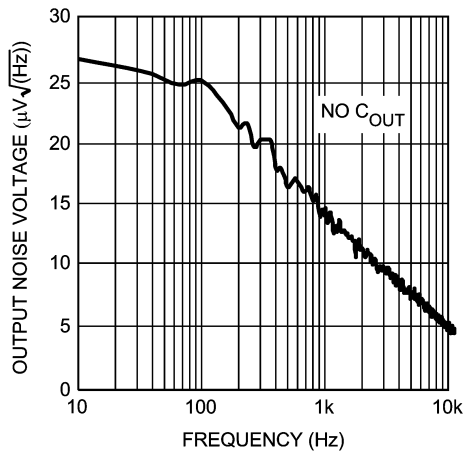

20151375

Power Supply Rejection vs Frequency

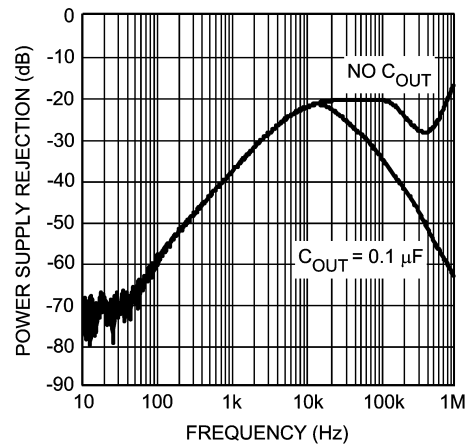

20151378

# Typical Performance Characteristics for 4.096V

Output Voltage vs Temperature

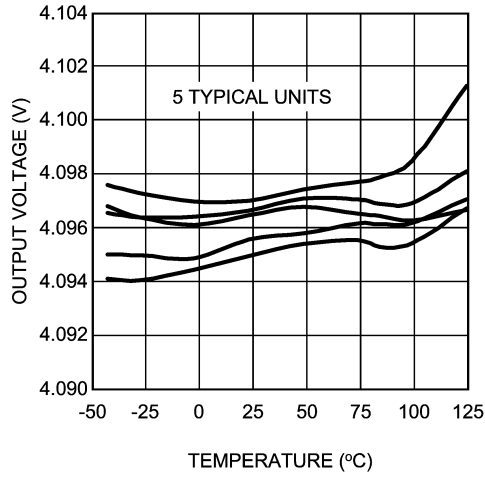

20151359

Load Regulation

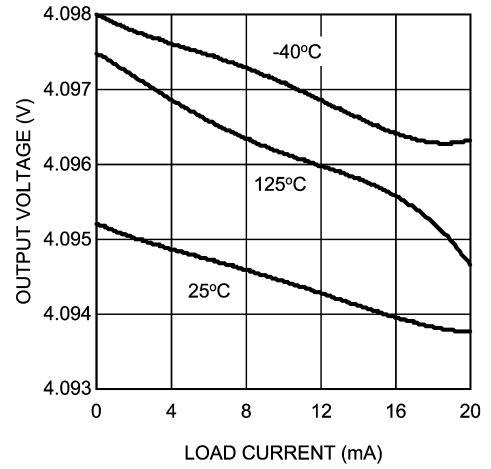

20151360

Line Regulation

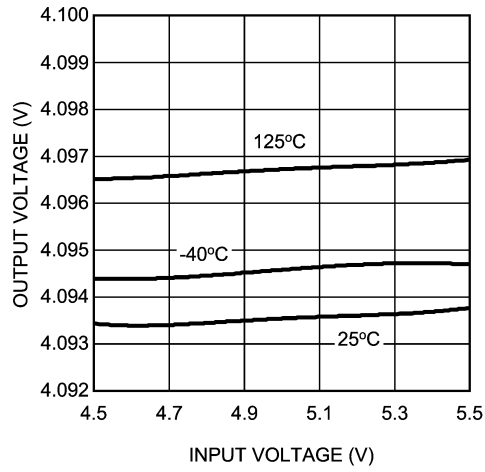

20151361

0.1 - 10 Hz Noise

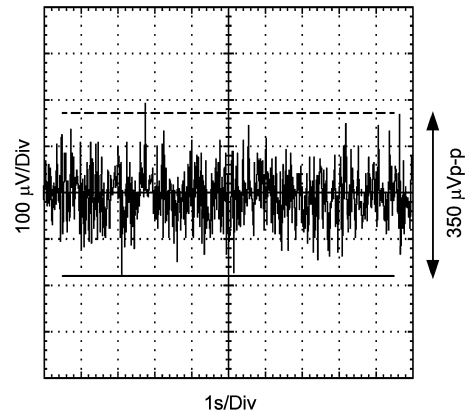

20151319

Output Voltage Noise Spectrum

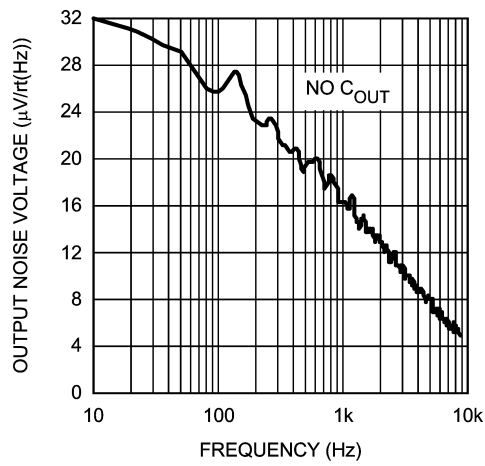

20151362

Power Supply Rejection vs Frequency

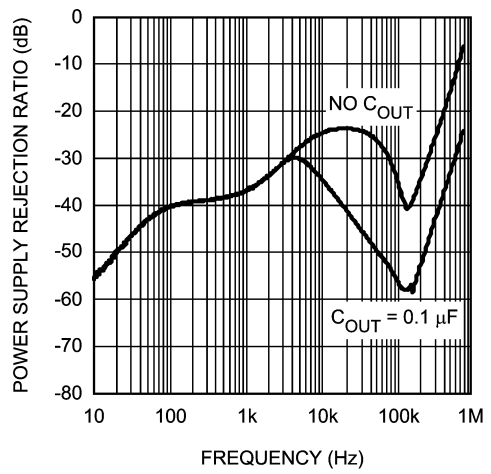

20151363

# Typical Performance Characteristics

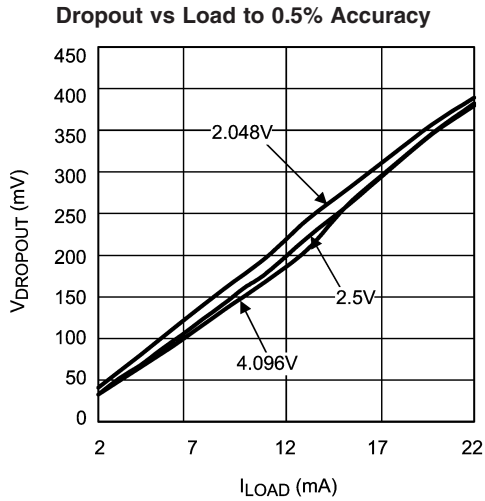

20151308

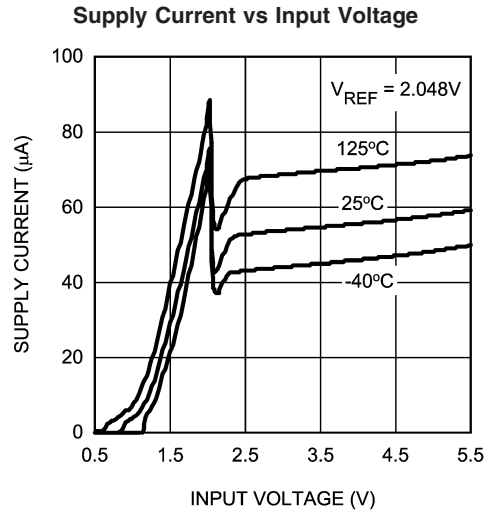

20151353

### Enable Threshold Voltage and Hysteresis

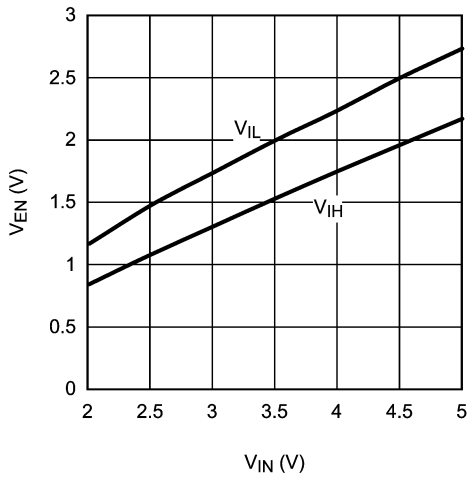

20151317

### Shutdown $I_Q$ vs Temperature

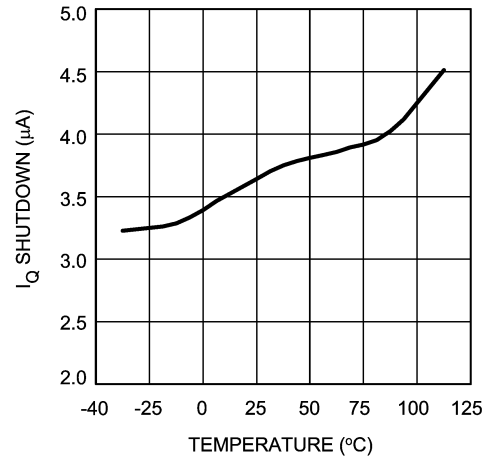

20151310

### Typical Long Term Stability

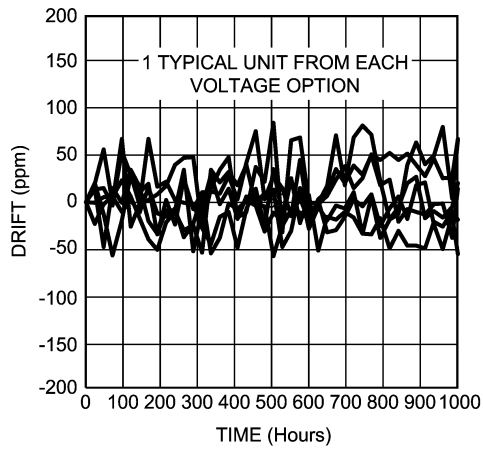

20151330

### Ground Current vs Load Current

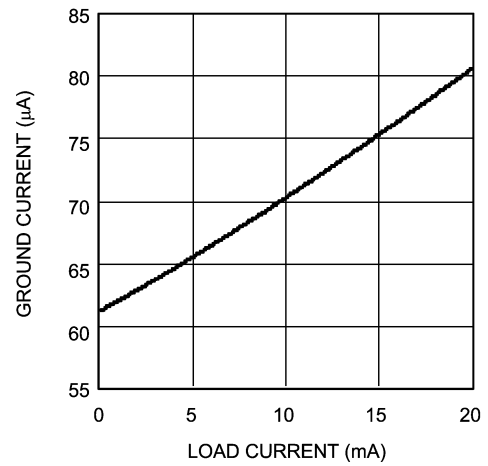

20151318



# Typical Performance Characteristics (Continued)

**Typical Thermal Hysteresis**

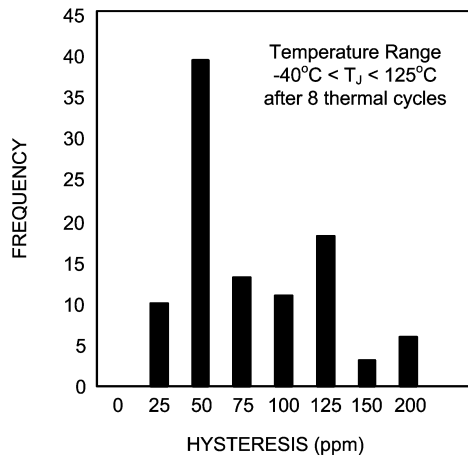

20151331

**Turn-On Transient Response**

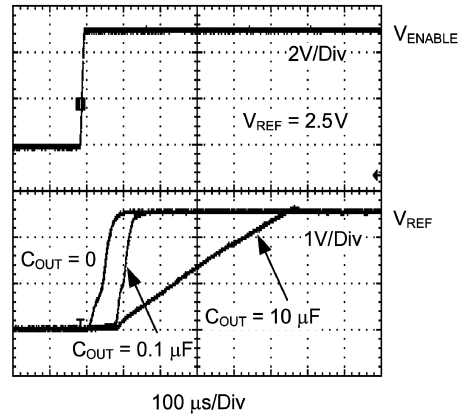

20151352

**Load Transient Response**  
 $I_{\text{LOAD}} = 0\ \text{to}\ 10\text{mA}$

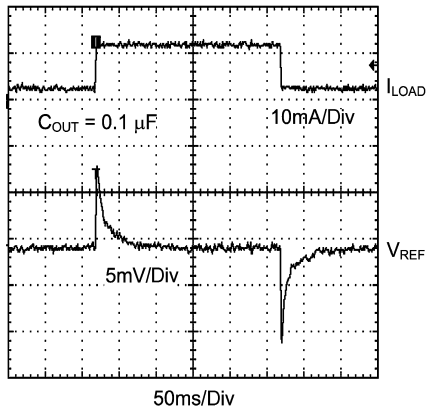

20151350

**Line Transient Response**  
 $V_{\text{IN}} = 4\text{V}\ \text{to}\ 5.5\text{V}$

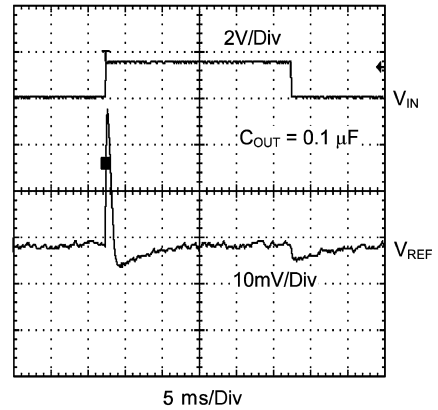

20151351

## Application Information

### THEORY OF OPERATION

The foundation of any voltage reference is the band-gap circuit. While the reference in the LM4132 is developed from the gate-source voltage of transistors in the IC, principles of the band-gap circuit are easily understood using a bipolar example. For a detailed analysis of the bipolar band-gap circuit, please refer to Application Note AN-56.

### SUPPLY AND ENABLE VOLTAGES

To ensure proper operation,  $V_{EN}$  and  $V_{IN}$  must be within a specified range. An acceptable range of input voltages is

$$V_{IN} > V_{REF} + 400\text{mV} \quad (I_{LOAD} \leq 10\text{mA})$$

The enable pin uses an internal pull-up current source ( $I_{PULL\_UP} \cong 2\mu\text{A}$ ) that may be left floating or triggered by an external source. If the part is not enabled by an external source, it may be connected to  $V_{IN}$ . An acceptable range of enable voltages is given by the enable transfer characteristics. See the Electrical Characteristics section and Enable Transfer Characteristics figure for more detail. Note, the part will not operate correctly for  $V_{EN} > V_{IN}$ .

### COMPONENT SELECTION

A small ceramic (X5R or X7R) capacitor on the input must be used to ensure stable operation. The value of  $C_{IN}$  must be sized according to the output capacitor value. The value of  $C_{IN}$  must satisfy the relationship  $C_{IN} \geq C_{OUT}$ . When no output capacitor is used,  $C_{IN}$  must have a minimum value of  $0.1\mu\text{F}$ . Noise on the power-supply input may affect the output noise. Larger input capacitor values (typically  $4.7\mu\text{F}$  to  $22\mu\text{F}$ ) may help reduce noise on the output and significantly reduce overshoot during startup. Use of an additional optional bypass capacitor between the input and ground may help further reduce noise on the output. With an input capacitor, the LM4132 will drive any combination of resistance and capacitance up to  $V_{REF}/20\text{mA}$  and  $10\mu\text{F}$  respectively.

The LM4132 is designed to operate with or without an output capacitor and is stable with capacitive loads up to  $10\mu\text{F}$ . Connecting a capacitor between the output and ground will significantly improve the load transient response when switching from a light load to a heavy load. The output capacitor should not be made arbitrarily large because it will effect the turn-on time as well as line and load transients.

While a variety of capacitor chemistry types may be used, it is typically advisable to use low esr ceramic capacitors. Such capacitors provide a low impedance to high frequency signals, effectively bypassing them to ground. Bypass capacitors should be mounted close to the part. Mounting bypass capacitors close to the part will help reduce the parasitic trace components thereby improving performance.

### SHORT CIRCUITED OUTPUT

The LM4132 features indefinite short circuit protection. This protection limits the output current to  $75\text{mA}$  when the output is shorted to ground.

### TURN ON TIME

Turn on time is defined as the time taken for the output voltage to rise to 90% of the preset value. The turn on time depends on the load. The turn on time is typically  $33.2\mu\text{s}$  when driving a  $1\mu\text{F}$  load and  $78.8\mu\text{s}$  when driving a  $10\mu\text{F}$  load. Some users may experience an extended turn on time (up to  $10\text{ms}$ ) under brown out conditions and low temperatures ( $-40^\circ\text{C}$ ).

### THERMAL HYSTERESIS

Thermal hysteresis is defined as the change in output voltage at  $25^\circ\text{C}$  after some deviation from  $25^\circ\text{C}$ . This is to say that thermal hysteresis is the difference in output voltage between two points in a given temperature profile. An illustrative temperature profile is shown in Figure 1.

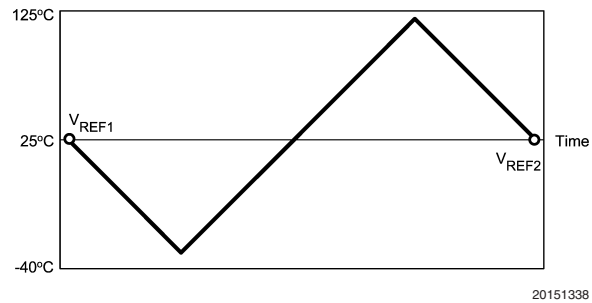

FIGURE 1. Illustrative Temperature Profile

This may be expressed analytically as the following:

$$V_{HYS} = \frac{|V_{REF1} - V_{REF2}|}{V_{REF}} \times 10^6 \text{ ppm}$$

Where

$V_{HYS}$  = Thermal hysteresis expressed in ppm

$V_{REF}$  = Nominal preset output voltage

$V_{REF1} = V_{REF}$  before temperature fluctuation

$V_{REF2} = V_{REF}$  after temperature fluctuation.

The LM4132 features a low thermal hysteresis of 75 ppm (typical) from  $-40^\circ\text{C}$  to  $125^\circ\text{C}$  after 8 temperature cycles.

### TEMPERATURE COEFFICIENT

Temperature drift is defined as the maximum deviation in output voltage over the operating temperature range. This deviation over temperature may be illustrated as shown in Figure 2.

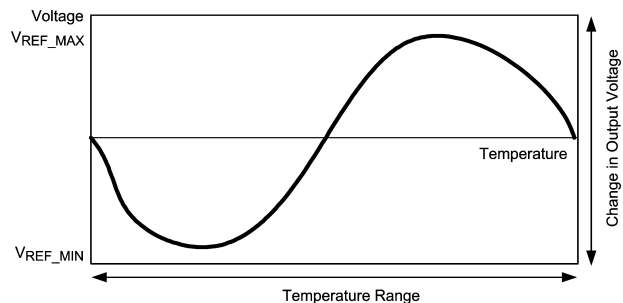

FIGURE 2. Illustrative  $V_{REF}$  vs Temperature Profile

Temperature coefficient may be expressed analytically as the following:

$$T_D = \frac{(V_{REF\_MAX} - V_{REF\_MIN})}{V_{REF} \times \Delta T} \times 10^6 \text{ ppm}$$

## Application Information (Continued)

$T_D$  = Temperature drift

$V_{REF}$  = Nominal preset output voltage

$V_{REF\_MIN}$  = Minimum output voltage over operating temperature range

$V_{REF\_MAX}$  = Maximum output voltage over operating temperature range

$\Delta T$  = Operating temperature range.

The LM4132 features a low temperature drift of 10ppm (max) to 30ppm (max), depending on the grade.

### LONG TERM STABILITY

Long-term stability refers to the fluctuation in output voltage over a long period of time (1000 hours). The LM4132 features a typical long-term stability of 50ppm over 1000 hours. The measurements are made using 5 units of each voltage option, at a nominal input voltage (5V), with no load, at room temperature.

### EXPRESSION OF ELECTRICAL CHARACTERISTICS

Electrical characteristics are typically expressed in mV, ppm, or a percentage of the nominal value. Depending on the application, one expression may be more useful than the other. To convert one quantity to the other one may apply the following:

ppm to mV error in output voltage:

$$\frac{V_{REF} \times \text{ppm}_{ERROR}}{10^3} = V_{ERROR}$$

Where:

$V_{REF}$  is in volts (V) and  $V_{ERROR}$  is in milli-volts (mV).

Bit error (1 bit) to voltage error (mV):

$$\frac{V_{REF}}{2^n} \times 10^3 = V_{ERROR}$$

$V_{REF}$  is in volts (V),  $V_{ERROR}$  is in milli-volts (mV), and n is the number of bits.

mV to ppm error in output voltage:

$$\frac{V_{ERROR}}{V_{REF}} \times 10^3 = \text{ppm}_{ERROR}$$

Where:

$V_{REF}$  is in volts (V) and  $V_{ERROR}$  is in milli-volts (mV).

Voltage error (mV) to percentage error (percent):

$$\frac{V_{ERROR}}{V_{REF}} \times 0.1 = \text{Percent\_Error}$$

Where:

$V_{REF}$  is in volts (V) and  $V_{ERROR}$  is in milli-volts (mV).

### PRINTED CIRCUIT BOARD and LAYOUT CONSIDERATIONS

References in SOT packages are generally less prone to PC board mounting than devices in Small Outline (SOIC) packages. To minimize the mechanical stress due to PC board mounting that can cause the output voltage to shift from its initial value, mount the reference on a low flex area of the PC board, such as near the edge or a corner.

The part may be isolated mechanically by cutting a U shape slot on the PCB for mounting the device. This approach also provides some thermal isolation from the rest of the circuit.

Bypass capacitors must be mounted close to the part. Mounting bypass capacitors close to the part will reduce the parasitic trace components thereby improving performance.

# Typical Application Circuits

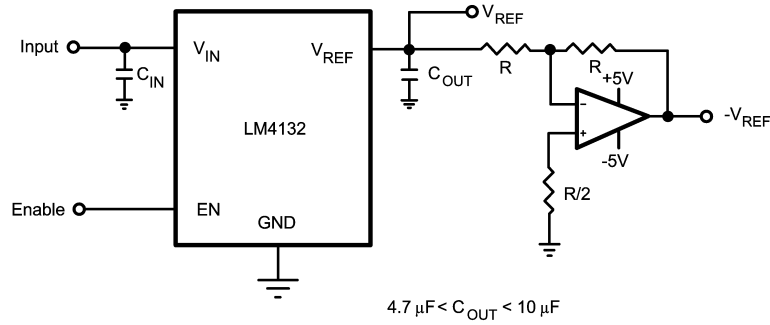

20151326

**FIGURE 3. Voltage Reference with Complimentary Output**

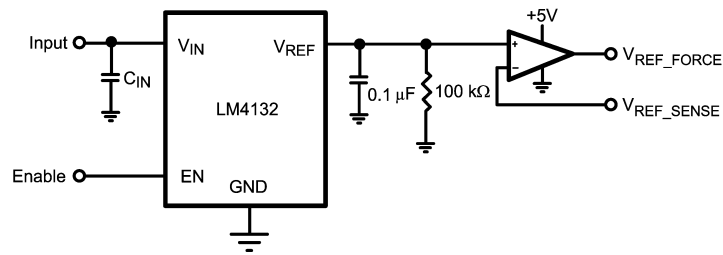

20151327

**FIGURE 4. Precision Voltage Reference with Force and Sense Output**

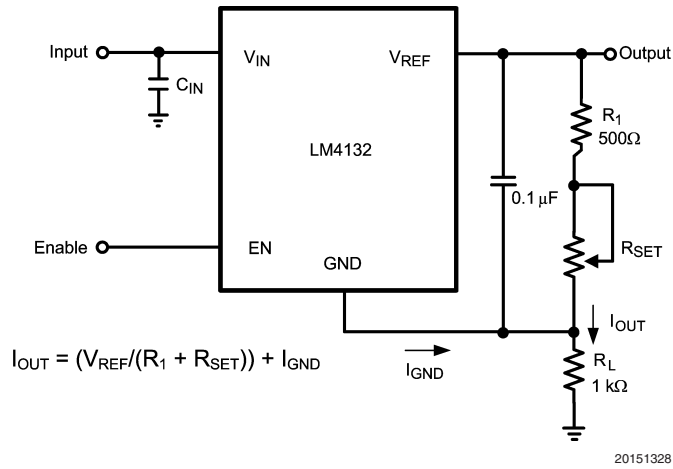

20151328

**FIGURE 5. Programmable Current Source**

## Physical Dimensions inches (millimeters) unless otherwise noted

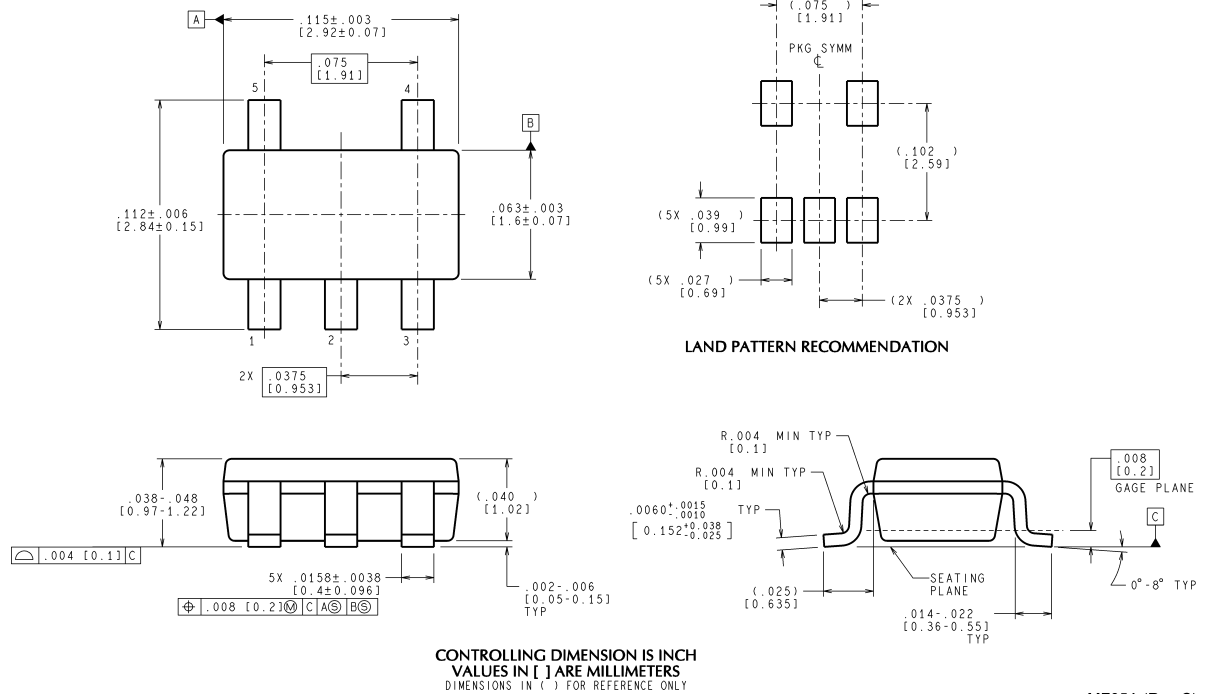

**SOT23-5 Package**  
**NS Package Number MF05A**

MF05A (Rev C)

National does not assume any responsibility for use of any circuitry described, no circuit patent licenses are implied and National reserves the right at any time without notice to change said circuitry and specifications.

For the most current product information visit us at [www.national.com](http://www.national.com).

### LIFE SUPPORT POLICY

NATIONAL'S PRODUCTS ARE NOT AUTHORIZED FOR USE AS CRITICAL COMPONENTS IN LIFE SUPPORT DEVICES OR SYSTEMS WITHOUT THE EXPRESS WRITTEN APPROVAL OF THE PRESIDENT AND GENERAL COUNSEL OF NATIONAL SEMICONDUCTOR CORPORATION. As used herein:

1. Life support devices or systems are devices or systems which, (a) are intended for surgical implant into the body, or (b) support or sustain life, and whose failure to perform when properly used in accordance with instructions for use provided in the labeling, can be reasonably expected to result in a significant injury to the user.
2. A critical component is any component of a life support device or system whose failure to perform can be reasonably expected to cause the failure of the life support device or system, or to affect its safety or effectiveness.

### BANNED SUBSTANCE COMPLIANCE

National Semiconductor follows the provisions of the Product Stewardship Guide for Customers (CSP-9-111C2) and Banned Substances and Materials of Interest Specification (CSP-9-111S2) for regulatory environmental compliance. Details may be found at: [www.national.com/quality/green](http://www.national.com/quality/green).

Lead free products are RoHS compliant.



**National Semiconductor**  
Americas Customer  
Support Center  
Email: [new.feedback@nsc.com](mailto:new.feedback@nsc.com)  
Tel: 1-800-272-9959

**National Semiconductor**  
Europe Customer Support Center  
Fax: +49 (0) 180-530 85 86  
Email: [europe.support@nsc.com](mailto:europe.support@nsc.com)  
Deutsch Tel: +49 (0) 69 9508 6208  
English Tel: +44 (0) 870 24 0 2171  
Français Tel: +33 (0) 1 41 91 8790

**National Semiconductor**  
Asia Pacific Customer  
Support Center  
Email: [ap.support@nsc.com](mailto:ap.support@nsc.com)

**National Semiconductor**  
Japan Customer Support Center  
Fax: 81-3-5639-7507  
Email: [jpn.feedback@nsc.com](mailto:jpn.feedback@nsc.com)  
Tel: 81-3-5639-7560