



PM-148/PM-248

QUAD 741

OPERATIONAL AMPLIFIERS

Precision Monolithics Inc.

FEATURES

Improved Specifications Over Industry Standard LM148

- Input Offset Voltage 2.5mV Max
- Input Offset Current 10nA Max
- Input Bias Current 75nA Max
- Small Signal Bandwidth 0.8MHz Typ
- Common-Mode Rejection Ratio 105dB Typ
- Power Supply Rejection Ratio 115dB Typ
- Phase Margin 80° Typ
- Available in Die Form

Fully Specified Over Military and Industrial Temperature Range

PIN CONNECTIONS

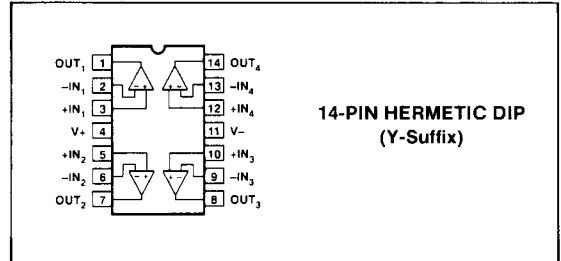

ORDERING INFORMATION†

V_{OS} MAX (mV)	PACKAGE	OPERATING TEMPERATURE RANGE
2.5	PM-148Y	MIL
2.5	PM-248Y	IND

† Burn-in is available on commercial and industrial temperature range parts in CerDIP, plastic DIP, and TO-can packages. For ordering information, see PMI's Data Book, Section 2.

GENERAL DESCRIPTION

The PM-148 is Precision Monolithics' improved version of the industry-standard LM148 quad 741, high gain, internally compensated, low-power operational amplifier, offered over the full military and industrial temperature ranges. The PM-148 provides functional characteristics identical to the LM148 and is a pin-for-pin replacement with significant improvements on the key parameters of input offset voltage, input bias current, and input offset current.

SIMPLIFIED SCHEMATIC (One of Four Amplifiers)

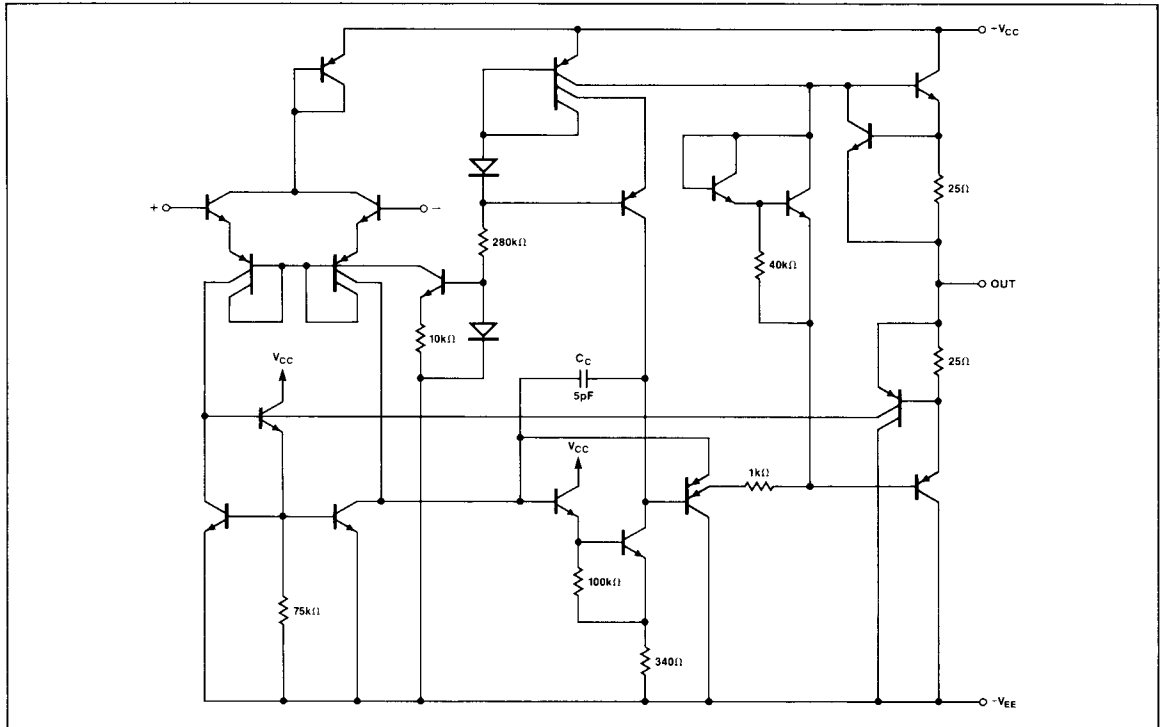

5
OPERATIONAL AMPLIFIERS/BUFFERS

Excellent isolation between amplifiers is achieved by independently biasing each amplifier and using layout techniques that minimize thermal coupling.

The PM-148 can be used anywhere multiple 741 or 1558 type amplifiers are being used and in applications where amplifier matching or high packing density is required. The improved performance of the PM-148 allows immediate upgrading of LM148 applications.

ABSOLUTE MAXIMUM RATINGS

Supply Voltage	$\pm 22V$
Differential Input Voltage	$\pm 44V$
Input Voltage	$\pm 22V$
Output Short Circuit Duration (Note 1)	Continuous

Maximum Junction Temperature	$+150^{\circ}C$
Operating Temperature Range	
PM-148	$-55^{\circ}C \leq T_A \leq +125^{\circ}C$
PM-248	$-25^{\circ}C \leq T_A \leq +85^{\circ}C$
Storage Temperature Range	$-65^{\circ}C$ to $+150^{\circ}C$
Lead Temperature Range	$+300^{\circ}C$

PACKAGE TYPE	θ_{JA} (Note 2)	θ_{JC}	UNITS
14-Pin Hermetic DIP (Y)	108	16	$^{\circ}C/W$

NOTES:

- Any of the amplifier outputs can be shorted to ground indefinitely; however, more than one should not be simultaneously shorted as the maximum junction temperature will be exceeded.
- θ_{JA} is specified for worst case mounting conditions, i.e., θ_{JA} is specified for device in socket for CerDIP package.

ELECTRICAL CHARACTERISTICS at $V_S = \pm 15V$, $T_A = 25^{\circ}C$, unless otherwise noted.

PARAMETER	SYMBOL	CONDITIONS	PM-148/PM-248			UNITS
			MIN	TYP	MAX	
Input Offset Voltage	V_{OS}	$R_S \leq 10k\Omega$	—	0.1	2.5	mV
Input Offset Current	I_{OS}		—	0.1	10	nA
Input Bias Current	I_B		—	20	75	nA
Input Resistance	R_{IN}	(Note 1)	0.8	2.5	—	M Ω
Supply Current	I_{SY}	$V_S = \pm 15V$	—	2.4	3.6	mA
Large Signal Voltage Gain	A_{VO}	$V_S = \pm 15V$ $V_{OUT} = \pm 10V, R_L \geq 2k\Omega$	50	150	—	V/mV
Positive Short Circuit Current	I_{SC}^+		—	18	—	mA
Negative Short Circuit Current	I_{SC}^-		—	36	—	mA
Common-Mode Rejection Ratio	CMRR	$R_S \leq 10k\Omega$	80	105	—	dB
Input Voltage Range	IVR	$V_S = \pm 15V$	± 12	—	—	V
Power Supply Rejection Ratio	PSRR	$R_S \leq 10k\Omega$	85	115	—	dB
Output Voltage Swing	V_O	$V_S = \pm 15V$ $R_L = 10k\Omega$ $R_L = 2k\Omega$	± 12 ± 11	± 13 ± 12.5	—	V
Slew Rate	SR	$A_V = 1$	—	0.4	—	V/ μs
Small Signal Bandwidth	BW		—	0.8	—	MHz
Phase Margin	0°	$A_V = 1$	—	80	—	degrees

NOTE:

- Guaranteed by formula $R_{IN} = \frac{4KT}{qI_B}$.

ELECTRICAL CHARACTERISTICS at $V_S = \pm 15V$, $-55^\circ C \leq T_A \leq +125^\circ C$, unless otherwise noted.

PARAMETER	SYMBOL	CONDITIONS	PM-148			UNITS
			MIN	TYP	MAX	
Input Offset Voltage	V_{OS}	$R_S \leq 10k\Omega$	—	0.6	6	mV
Input Offset Current	I_{OS}		—	0.5	25	nA
Input Bias Current	I_B		—	30	100	nA
Supply Current	I_{SV}	$V_S = \pm 15V$ $T_A \leq +125^\circ C$ $T_A \geq -55^\circ C$	—	2.4	3.6	mA
			—	3.5	4.5	
Large Signal Voltage Gain	A_{VO}	$V_S = \pm 15V$ $V_{OUT} = \pm 10V$, $R_L \geq 2k\Omega$	25	75	—	V/mV
Common-Mode Rejection Ratio	CMRR	$R_S \leq 10k\Omega$	80	100	—	dB
Power Supply Rejection Ratio	PSRR		80	95	—	dB
Output Voltage Swing	V_O	$V_S = \pm 15V$ $R_L = 10k\Omega$ $R_L = 2k\Omega$	± 12 ± 10	± 13 ± 12	—	V
Input Voltage Range	IVR	$V_S = \pm 15V$	± 12	—	—	V

ELECTRICAL CHARACTERISTICS at $V_S = \pm 15V$, $-25^\circ C \leq T_A \leq -85^\circ C$, unless otherwise noted.

PARAMETER	SYMBOL	CONDITIONS	PM-248			UNITS
			MIN	TYP	MAX	
Input Offset Voltage	V_{OS}	$R_S \leq 10k\Omega$	—	—	7.5	mV
Input Offset Current	I_{OS}		—	—	125	nA
Input Bias Current	I_B		—	—	500	nA
Supply Current	I_{SV}	$V_S = \pm 15V$	—	2.4	4.5	mA
Large Signal Voltage Gain	A_{VO}	$V_S = \pm 15V$ $V_{OUT} = \pm 10V$, $R_L \geq 2k\Omega$	15	—	—	V/mV
Common-Mode Rejection Ratio	CMRR	$R_S \leq 10k\Omega$	70	90	—	dB
Power Supply Rejection Ratio	PSRR	$R_S \leq 10k\Omega$	77	96	—	dB
Output Voltage Swing	V_O	$V_S = \pm 15V$ $R_L = 10k\Omega$ $R_L = 2k\Omega$	± 12 ± 10	± 13 ± 12	—	V
Input Voltage Range	IVR	$V_S = \pm 15V$	± 12	—	—	V

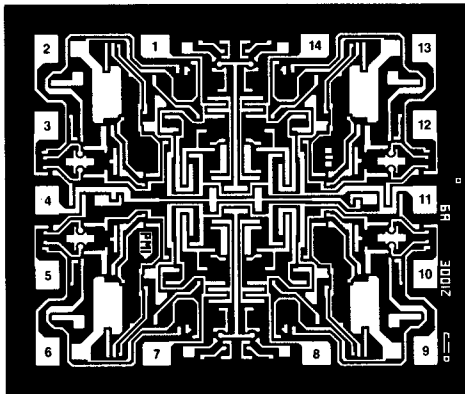
DICE CHARACTERISTICS

DIE SIZE 0.064 × 0.075 inch, 4800 sq. mils
(1.62 × 1.90 mm, 3.08 sq. mm)

1. OUT 1
2. IN 1
3. IN 1+
4. V+
5. IN 2+
6. IN 2
7. OUT 2
8. OUT 3
9. IN 3
10. IN 3+
11. V-
12. IN 4+
13. IN 4
14. OUT 4

For additional DICE ordering information, refer to PMI's Data Book, Section 2.

WAFER TEST LIMITS at $V_S = \pm 15V$, $T_A = 25^\circ C$ for PM-148GBC, $T_A = 125^\circ C$ for PM-148GTBC, unless otherwise noted.

PARAMETER	SYMBOL	CONDITIONS	PM-148GBC LIMIT	PM-148GTBC LIMIT	UNITS
Input Offset Voltage	V_{OS}	$R_S \leq 10k\Omega$	2.5	6.0	mV MAX
Input Offset Current	I_{OS}		10	25	nA MAX
Input Bias Current	I_B		75	100	nA MAX
Supply Current	I_{SY}	$V_S = \pm 15V$	3.6	3.6	mA MAX
Large Signal Voltage Gain	A_{VO}	$V_S = \pm 15V$ $V_{OUT} = \pm 10V$, $R_L \geq 2k\Omega$	50	25	V/mV MIN
Common-Mode Rejection Ratio	CMRR	$R_S \leq 10k\Omega$	80	80	dB MIN
Power Supply Rejection Ratio	PSRR	$R_S \leq 10k\Omega$	85	80	dB MIN
Output Voltage Swing	V_O	$V_S = \pm 15V$, $R_L = 10k\Omega$ $R_L = 2k\Omega$	± 12 ± 11	± 12 ± 10	V MIN
Input Voltage Range	IVR	$V_S = \pm 15V$	± 12	± 12	V MIN

NOTE:

Electrical tests are performed at wafer probe to the limits shown. Due to variations in assembly methods and normal yield loss, yield after packaging is not guaranteed for standard product dice. Consult factory to negotiate specifications based on dice lot qualification through sample lot assembly and testing.

TYPICAL PERFORMANCE CHARACTERISTICS

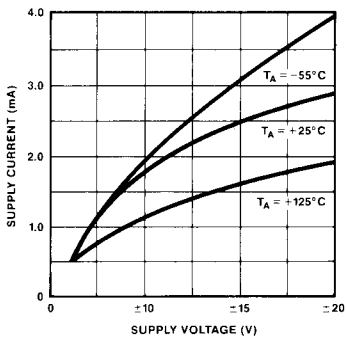
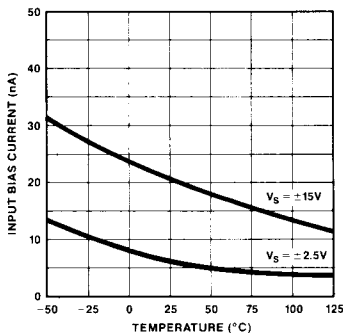
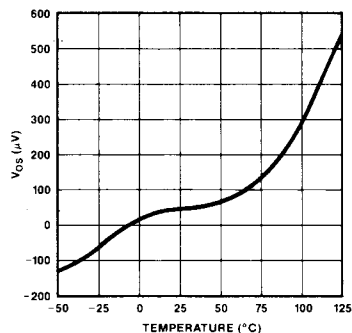
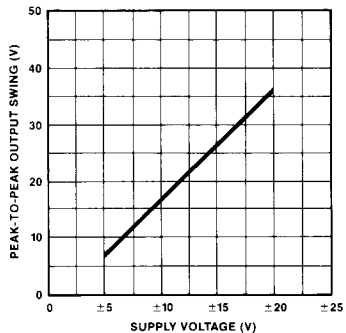
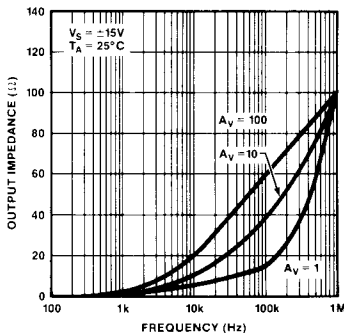
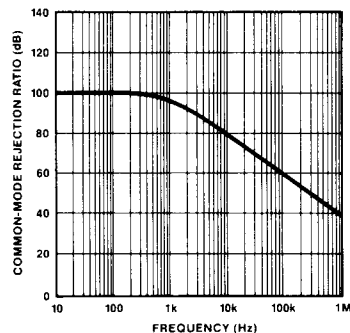
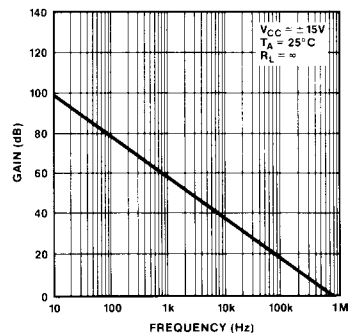
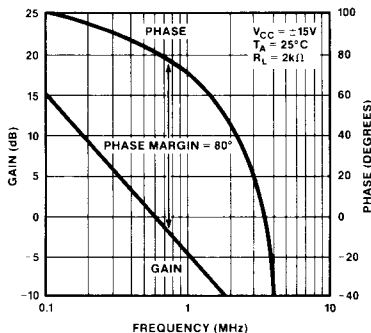
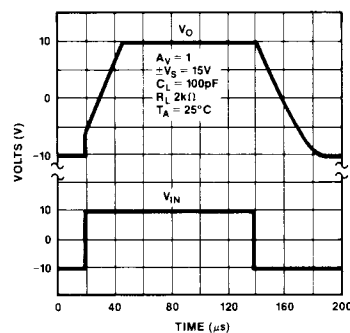
SUPPLY CURRENT vs SUPPLY VOLTAGE

INPUT BIAS CURRENT vs TEMPERATURE

INPUT OFFSET VOLTAGE vs TEMPERATURE

VOLTAGE SWING vs SUPPLY VOLTAGE

OUTPUT IMPEDANCE vs FREQUENCY

COMMON-MODE REJECTION RATIO vs FREQUENCY

OPEN-LOOP FREQUENCY RESPONSE vs GAIN

GAIN AND PHASE vs FREQUENCY

LARGE SIGNAL PULSE RESPONSE

OPERATIONAL AMPLIFIERS/BUFFERS



TYPICAL PERFORMANCE CHARACTERISTICS

