

# HA-2620/883 HA-2622/883

## Very Wideband, High Impedance Uncompensated Operational Amplifiers

January 1989

### Features

- This Circuit is Processed in Accordance to MIL-Std-883 and is Fully Conformant Under the Provisions of Paragraph 1.2.1.
- High Input Impedance (HA-2620/883) .... 65M $\Omega$  Min
- High Gain (HA-2620/883) ..... 100kV/V Min  
150kV/V Typ
- High Slew Rate (HA-2620/883) ..... 25V/ $\mu$ s Min  
35V/ $\mu$ s Typ
- Low Input Bias Current (HA-2620/883) .... 15nA Max  
5nA Typ
- Low Input Offset Voltage (HA-2620/883) .. 4mV Max
- Wide Gain Bandwidth Product ( $A_V \geq 5$ ) ... 100MHz Typ
- Output Short Circuit Protection

### Applications

- Video and R.F. Amplifiers
- Pulse Amplifiers
- Audio Amplifiers and Filters
- High-Q Active Filters
- High Speed Comparators

### Description

HA-2620/883 and HA-2622/883 are bipolar operational amplifiers that feature very high input impedance coupled with wideband A.C. performance. The high resistance of the input stage is complemented by low offset voltage (4mV<sub>max</sub> @ +25°C for HA-2620/883) and low bias and offset current (15nA<sub>max</sub> @ +25°C for HA-2620/883) to facilitate accurate signal processing. Offset voltage can be reduced further by means of an external nulling potentiometer. With the HA-2620/883, which is stable for closed loop gains greater than 5, the 25V/ $\mu$ s minimum slew rate at +25°C and the 100kV/V minimum open loop gain at +25°C, enables the HA-2620/883 to perform high gain amplification of very fast, wideband signals. These dynamic characteristics, coupled with fast settling times, make these amplifiers ideally suited to pulse amplification designs as well as high frequency or video applications. The frequency response of the amplifier can be tailored to exact design requirements by means of an external bandwidth control capacitor. Other high performance designs such as high gain, low distortion audio amplifiers, high-Q and wideband active filters and high speed comparators are excellent uses of this part.

The HA-2620/883 and the HA-2622/883 are available as MIL-STD-883 compliant devices screened to class B level. These devices are sensitive to electrostatic discharge and are in microcircuit group number 49 (see MIL-M-38510, Appendix E). The HA-2620/883 and the HA-2622/883 have guaranteed operation over the military temperature range from -55°C to +125°C and are available in 8 pin Metal Can and Ceramic Mini-DIP packages. The HA-2622/883 is also available in a 20 pin Ceramic LCC package.

### Pinouts

HA7-2620/883 (CERAMIC MINI-DIP)  
HA7-2622/883 (CERAMIC MINI-DIP)  
TOP VIEW

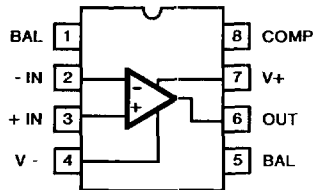

HA4-2622/883 (CERAMIC LCC)  
TOP VIEW

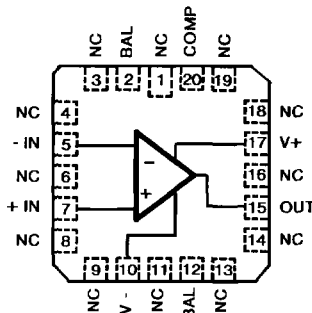

HA2-2620/883 (METAL CAN)  
HA2-2622/883 (METAL CAN)  
TOP VIEW

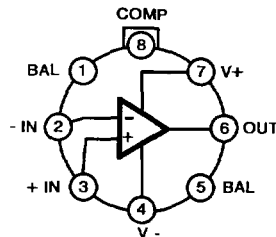

**Absolute Maximum Ratings**

Voltage Between V+ and V- Terminals	40V
Differential Input Voltage	12V
Voltage at Either Input Terminal	V+ to V-
Peak Output Current	Full Short Circuit Protection
Junction Temperature (T <sub>J</sub> )	+175°C
Storage Temperature Range	-65°C to +150°C
ESD Rating	< 2000V
Lead Temperature (Soldering 10 sec)	275°C

CAUTION: Absolute maximum ratings are limiting values, applied individually beyond which the serviceability of the circuit may be impaired. Functional operability under any of these conditions is not necessarily implied.

**Thermal Information**

Thermal Resistance	$\theta_{ja}$	$\theta_{jc}$
Ceramic DIP Package	82°C/W	28°C/W
Ceramic LCC Package	74°C/W	20°C/W
Metal Can Package	136°C/W	41°C/W
Package Power Dissipation Limit at +75°C for T <sub>J</sub> ≤ +175°C		
Ceramic DIP Package	730mW	
Ceramic LCC Package	1.35W	
Metal Can Package	740mW	
Package Power Dissipation Derating Factor Above +75°C		
Ceramic DIP Package	7.4mW/°C	
Ceramic LCC Package	13.4mW/°C	
Metal Can Package	7.4mW/°C	

**Recommended Operating Conditions**

Operating Temperature Range	-55°C to +125°C	$V_{INcm} \leq 1/2 (V+ - V-)$
Operating Supply Voltage	±15V	$R_L \geq 2k\Omega$

**TABLE 1. D.C. ELECTRICAL PERFORMANCE CHARACTERISTICS**

Device Tested at: Supply Voltage = ±15V, R<sub>SOURCE</sub> = 100Ω, R<sub>LOAD</sub> = 500kΩ, V<sub>OUT</sub> = 0V, Unless Otherwise Specified.

D.C. PARAMETERS	SYMBOL	CONDITIONS	GROUP A SUBGROUP	TEMPERATURE	HA-2620/883		HA-2622/883		UNITS
					MIN	MAX	MIN	MAX	
Input Offset Voltage	V <sub>IO</sub>	V <sub>CM</sub> = 0V	1	+25°C	-4	4	-5	5	mV
			2, 3	+125°C, -55°C	-6	6	-7	7	mV
Input Bias Current	+I <sub>B</sub>	V <sub>CM</sub> = 0V +R <sub>S</sub> = 100kΩ -R <sub>S</sub> = 100Ω	1	+25°C	-15	15	-25	25	nA
			2, 3	+125°C, -55°C	-30	30	-60	60	nA
	-I <sub>B</sub>	V <sub>CM</sub> = 0V +R <sub>S</sub> = 100Ω -R <sub>S</sub> = 100kΩ	1	+25°C	-15	15	-25	25	nA
			2, 3	+125°C, -55°C	-30	30	-60	60	nA
Input Offset Current	I <sub>IO</sub>	V <sub>CM</sub> = 0V +R <sub>S</sub> = 100kΩ -R <sub>S</sub> = 100kΩ	1	+25°C	-15	15	-25	25	nA
			2, 3	+125°C, -55°C	-30	30	-60	60	nA
Common Mode Range	+CMR	V+ = 4V V- = -26V	1	+25°C	11	-	11	-	V
			2, 3	+125°C, -55°C	11	-	11	-	V
	-CMR	V+ = 26V V- = -4V	1	+25°C	-	-11	-	-11	V
			2, 3	+125°C, -55°C	-	-11	-	-11	V
Large Signal Voltage Gain	+A <sub>VOL</sub>	V <sub>OUT</sub> = 0V and +10V R <sub>L</sub> = 2kΩ	4	+25°C	100	-	80	-	kV/V
			5, 6	+125°C, -55°C	70	-	60	-	kV/V
	-A <sub>VOL</sub>	V <sub>OUT</sub> = 0V and -10V R <sub>L</sub> = 2kΩ	4	+25°C	100	-	80	-	kV/V
			5, 6	+125°C, -55°C	70	-	60	-	kV/V
Common Mode Rejection Ratio	+CMRR	ΔV <sub>CM</sub> = +10V +V = +5V -V = -25V V <sub>OUT</sub> = -10V	1	+25°C	80	-	74	-	dB
			2, 3	+125°C, -55°C	80	-	74	-	dB
	-CMRR	ΔV <sub>CM</sub> = -10V +V = +25V -V = -5V V <sub>OUT</sub> = +10V	1	+25°C	80	-	74	-	dB
			2, 3	+125°C, -55°C	80	-	74	-	dB

CAUTION: This device is sensitive to electrostatic discharge. Proper I.C. handling procedures should be followed.

TABLE 1. D.C. ELECTRICAL PERFORMANCE CHARACTERISTICS (Continued)

Device Tested at: Supply Voltage = ±15V, R<sub>SOURCE</sub> = 100Ω, R<sub>LOAD</sub> = 500kΩ, V<sub>OUT</sub> = 0V, Unless Otherwise Specified.

D.C. PARAMETERS	SYMBOL	CONDITIONS	GROUP A SUBGROUP	TEMPERATURE	HA-2620/883		HA-2622/883		UNITS
					MIN	MAX	MIN	MAX	
Output Voltage Swing	+V <sub>OUT</sub>	R <sub>L</sub> = 2kΩ	4	+25°C	10	-	10	-	V
			5, 6	+125°C, -55°C	10	-	10	-	V
	-V <sub>OUT</sub>	R <sub>L</sub> = 2kΩ	4	+25°C	-	-10	-	-10	V
			5, 6	+125°C, -55°C	-	-10	-	-10	V
Output Current	+I <sub>OUT</sub>	V <sub>OUT</sub> = -10V	4	+25°C	15	-	10	-	mA
			5, 6	+125°C, -55°C	10	-	7.5	-	mA
	-I <sub>OUT</sub>	V <sub>OUT</sub> = +10V	4	+25°C	-	-15	-	-10	mA
			5, 6	+125°C, -55°C	-	-10	-	-7.5	mA
Quiescent Power Supply Current	+I <sub>CC</sub>	V <sub>OUT</sub> = 0V I <sub>OUT</sub> = 0mA	1	+25°C	-	3.7	-	3.7	mA
			2, 3	+125°C, -55°C	-	4.0	-	4.0	mA
	-I <sub>CC</sub>	V <sub>OUT</sub> = 0V I <sub>OUT</sub> = 0mA	1	+25°C	-3.7	-	-3.7	-	mA
			2, 3	+125°C, -55°C	-4.0	-	-4.0	-	mA
Power Supply Rejection Ratio	+PSRR	ΔV <sub>SUP</sub> = ± 5 +V = +10V, -V = -15V +V = +20V, -V = -15V	1	+25°C	80	-	74	-	dB
			2, 3	+125°C, -55°C	80	-	74	-	dB
	-PSRR	ΔV <sub>SUP</sub> = ± 5V +V = +15V, -V = -10V +V = +15V, -V = -20V	1	+25°C	80	-	74	-	dB
			2, 3	+125°C, -55°C	80	-	74	-	dB

TABLE 2. A.C. ELECTRICAL PERFORMANCE CHARACTERISTICS

Device Tested at: Supply Voltage = ±15V, R<sub>SOURCE</sub> = 50Ω, R<sub>LOAD</sub> = 2kΩ, C<sub>LOAD</sub> = 50pF, A<sub>VCL</sub> = +5V/V, Unless Otherwise Specified.

PARAMETERS	SYMBOL	CONDITIONS	GROUP A SUBGROUP	TEMPERATURE	HA-2620/883		HA-2622/883		UNITS
					MIN	MAX	MIN	MAX	
Slew Rate	+SR	V <sub>OUT</sub> = -5V to +5V	7	+25°C	25	-	20	-	V/μs
			8A, 8B	+125°C, -55°C	20	-	15	-	V/μs
	-SR	V <sub>OUT</sub> = +5V to -5V	7	+25°C	25	-	20	-	V/μs
			8A, 8B	+125°C, -55°C	20	-	15	-	V/μs
Rise & Fall Time	T <sub>R</sub>	V <sub>OUT</sub> = 0 to +200mV 10% ≤ T <sub>R</sub> ≤ 90%	7	+25°C	-	45	-	45	ns
			8A, 8B	+125°C, -55°C	-	60	-	70	ns
	T <sub>F</sub>	V <sub>OUT</sub> = 0 to -200mV 10% ≤ T <sub>F</sub> ≤ 90%	7	+25°C	-	45	-	45	ns
			8A, 8B	+125°C, -55°C	-	60	-	70	ns
Overshoot	+OS	V <sub>OUT</sub> = 0 to +200mV	7	+25°C	-	70	-	80	%
			8A, 8B	+125°C, -55°C	-	70	-	80	%
	-OS	V <sub>OUT</sub> = 0 to -200mV	7	+25°C	-	70	-	80	%
			8A, 8B	+125°C, -55°C	-	70	-	80	%

TABLE 3. ELECTRICAL PERFORMANCE CHARACTERISTICS

Device Characterized at: Supply Voltage = ±15V, R<sub>LOAD</sub> = 2kΩ, C<sub>LOAD</sub> = 50pF, Unless Otherwise Specified.

PARAMETERS	SYMBOL	CONDITIONS	NOTES	TEMPERATURE	HA-2620/883		HA-2622/883		UNITS
					MIN	MAX	MIN	MAX	
Differential Input Resistance	R <sub>IN</sub>	V <sub>CM</sub> = 0V	1	+25°C	65	-	40	-	MΩ
Full Power Bandwidth	FPBW	V <sub>PEAK</sub> = 10V	1, 2	+25°C	400	-	320	-	kHz
Minimum Closed Loop Stable Gain	CLSG	R <sub>L</sub> = 2kΩ, C <sub>L</sub> = 50pF	1	-55°C to +125°C	5	-	5	-	V/V
Output Short Circuit Current	+I <sub>SC</sub>	V <sub>OUT</sub> = 1V, R <sub>L</sub> = 10Ω	1	+25°C	-	50	-	50	mA
			1	+125°C	-	45	-	45	mA
			1	-55°C	-	60	-	60	mA
	-I <sub>SC</sub>	V <sub>OUT</sub> = -1V, R <sub>L</sub> = 10Ω	1	+25°C	-50	-	-50	-	mA
			1	+125°C	-45	-	-45	-	mA
			1	-55°C	-60	-	-60	-	mA
Output Resistance	R <sub>OUT</sub>	Open Loop	1	+25°C	-	30	-	30	Ω
Quiescent Power Consumption	PC	V <sub>OUT</sub> = 0V, I <sub>OUT</sub> = 0mA	1, 3	-55°C to +125°C	-	240	-	240	mW

NOTES: 1. Parameters listed in Table 3 are controlled via design or process parameters and are not directly tested at final production. These parameters are lab characterized upon initial design release, or upon design changes. These parameters are guaranteed by characterization based upon data from multiple production runs which reflect lot to lot and within lot variation.

- 2. Full Power Bandwidth guarantee based on Slew Rate measurement using FPBW = Slew Rate/(2πV<sub>PEAK</sub>).
- 3. Quiescent Power Consumption based upon Quiescent Supply Current test maximum. (No load on outputs.)

TABLE 4. ELECTRICAL TEST REQUIREMENTS

MIL-STD-883 TEST REQUIREMENTS	SUBGROUPS (SEE TABLES 1 & 2)
Interim Electrical Parameters (Pre Burn-In)	1
Final Electrical Test Parameters	1*, 2, 3, 4, 5, 6, 7, 8A, 8B
Group A Test Requirements	1, 2, 3, 4, 5, 6, 7, 8A, 8B
Groups C & D Endpoints	1

\* PDA applies to Subgroup 1 only.

The Subgroup assignment of the parameters in these tables were patterned after Mil-M-38510/112, device type 03.

**3**  
 OP AMPS &  
 COMPARATORS

**Test Circuit** (Applies to Table 1 and 2)

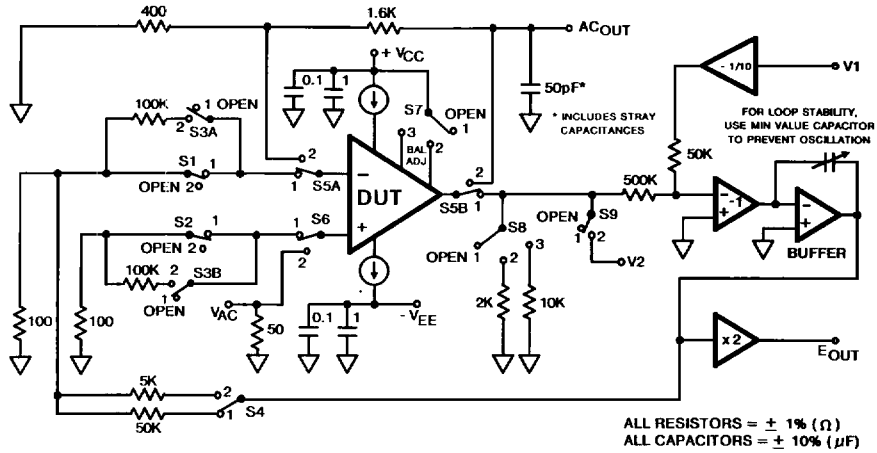

For Detailed Information, Refer to HA-2620/883; HA-2622/883 Test Tech Brief

**Test Waveforms**

**SIMPLIFIED TEST CIRCUIT** (Applies to Table 2)

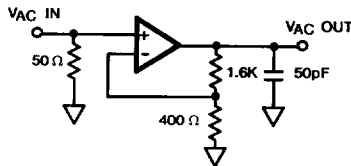

**SLEW RATE WAVEFORMS**

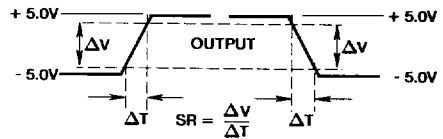
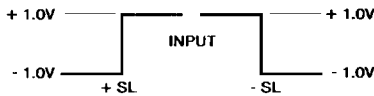

**OVERSHOOT, RISE & FALL TIME WAVEFORMS**

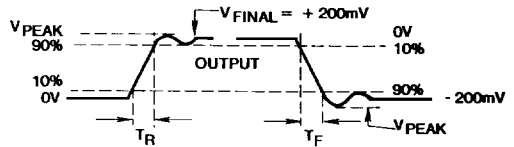
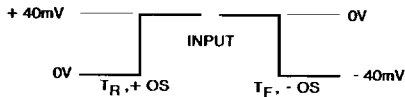

NOTE: Measured on both positive and negative transitions.  
Capacitance at Compensation pin should be minimized.

**Burn-In Circuits**

HA7-2620/883 CERAMIC MINI-DIP  
HA7-2622/883 CERAMIC MINI-DIP

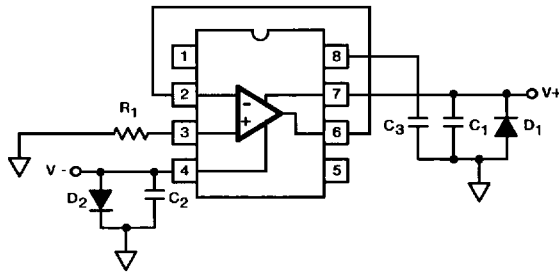

HA4-2622/883 CERAMIC LCC

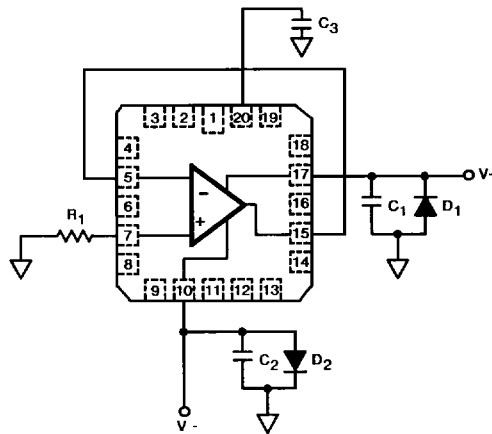

HA2-2620/883 (TO-99) METAL CAN  
HA2-2622/883 (TO-99) METAL CAN

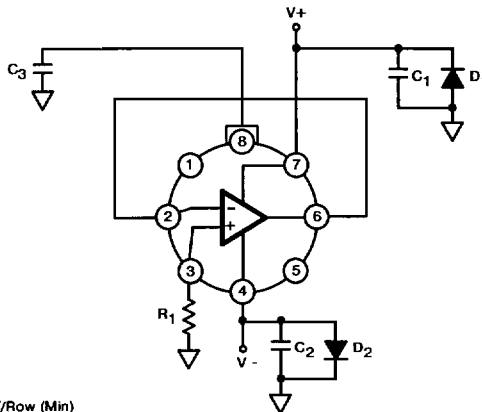

**NOTES:**

- R<sub>1</sub> = 1MΩ, ±5%, 1/4W (Min)
- C<sub>1</sub> = C<sub>2</sub> = 0.01μF/Socket (Min) or 0.1μF/Row (Min)
- C<sub>3</sub> = 0.01μF/Socket (10%)
- D<sub>1</sub> = D<sub>2</sub> = 1N4002 or Equivalent/Board
- |V<sub>+</sub> - V<sub>-</sub>| = 30V



**Die Characteristics**

**DIE DIMENSIONS:**

73 x 52 x 19 mils  
(1860 x 1320 x 483  $\mu\text{m}$ )

**METALLIZATION:**

Type: Aluminum  
Thickness:  $16\text{k}\text{\AA} \pm 2\text{k}\text{\AA}$

**WORST CASE CURRENT DENSITY:**

$1.5 \times 10^5 \text{A/cm}^2$  @ 19mA

**SUBSTRATE POTENTIAL (Powered Up):**

Unbiased

**GLASSIVATION:**

Type: Nitride  
Thickness:  $7\text{k}\text{\AA} \pm 0.7\text{k}\text{\AA}$

**TRANSISTOR COUNT:**

HA-2620/883: 140  
HA-2622/883: 140

**PROCESS:** Std. Linear Bipolar Dielectric Isolation

**DIE ATTACH:**

Material: Gold/Silicon Eutectic Alloy  
Temperature: Ceramic DIP —  $460^\circ\text{C}$  (Max)  
Ceramic LCC —  $420^\circ\text{C}$  (Max)  
Metal Can —  $420^\circ\text{C}$  (Max)

**Metallization Mask Layout**

HA-2620/883 HA-2622/883

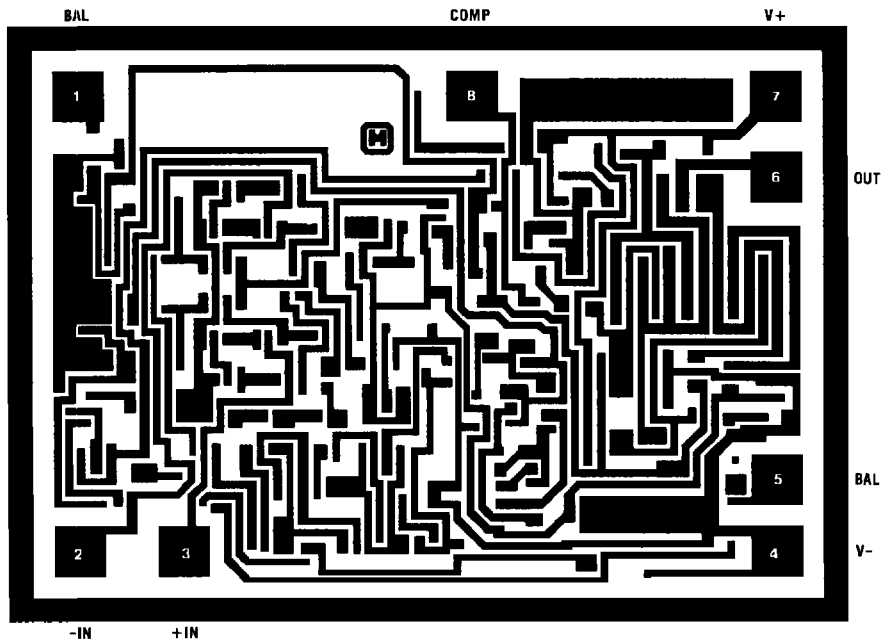

NOTE: Pin Numbers Correspond to 8 Pin Metal Can and Ceramic Mini-Dip Packages Only.

**3**  
 OP AMPS &  
 COMPARATORS



**Packaging †**

**8 PIN CERAMIC DIP**

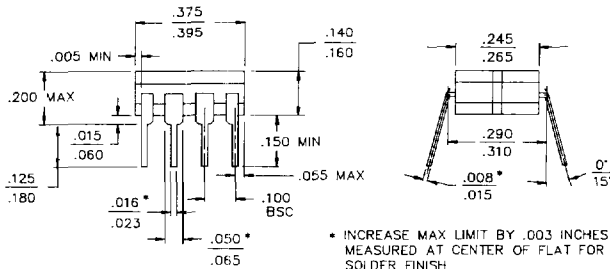

**LEAD MATERIAL:** Type B  
**LEAD FINISH:** Type A  
**PACKAGE MATERIAL:** Ceramic, 90% Alumina  
**PACKAGE SEAL:**  
 Material: Glass Frit  
 Temperature: 450°C ± 10°C  
 Method: Furnace Seal  
**INTERNAL LEAD WIRE:**  
 Material: Aluminum  
 Diameter: 1.25 Mil  
 Bonding Method: Ultrasonic  
**COMPLIANT OUTLINE:** 38510 D-4

**20 PAD CERAMIC LCC**

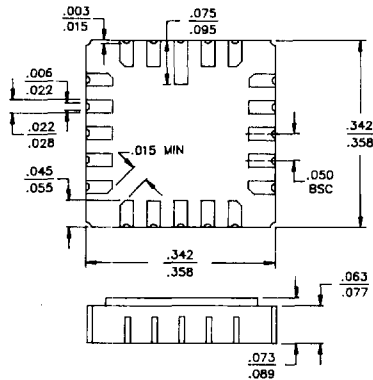

**PAD MATERIAL:** Type C  
**PAD FINISH:** Type A  
**FINISH DIMENSION:** Type A  
**PACKAGE MATERIAL:** Ceramic, 90% Al<sub>2</sub>O<sub>3</sub>  
**PACKAGE SEAL:**  
 Material: Gold/Tin (80/20)  
 Temperature: 320°C ± 10°C  
 Method: Furnace Braze  
**INTERNAL LEAD WIRE:**  
 Material: Aluminum  
 Diameter: 1.25 Mil  
 Bonding Method: Ultrasonic  
**COMPLIANT OUTLINE:** 38510 C-2

**8 PIN TO-99 METAL CAN**

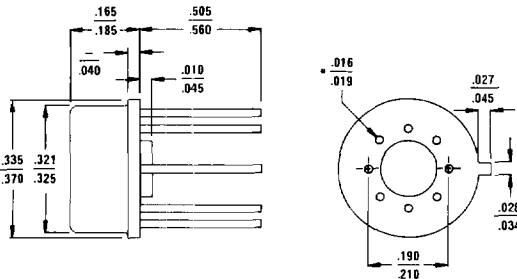

**LEAD MATERIAL:** Type A  
**LEAD FINISH:** Type C  
**PACKAGE MATERIAL:** Kovar Header with Nickel Can  
**PACKAGE SEAL:**  
 Material: No Seal Material  
 Temperature: Room Temperature  
 Method: Resistance Weld  
**INTERNAL LEAD WIRE:**  
 Material: Aluminum  
 Diameter: 1.25 Mil  
 Bonding Method: Ultrasonic Bonded  
**COMPLIANT OUTLINE:** 38510 A-1

\*Dimension Maximum Limits Are Increased by 0.003 inches for Solder Dip Finish

NOTE: All Dimensions are  $\frac{\text{Min}}{\text{Max}}$ , Dimensions are in inches.

†Mil-M-38510 Compliant Materials, Finishes, and Dimensions.

## DESIGN INFORMATION

## Very Wideband, Uncompensated Operational Amplifiers

The information contained in this section has been developed through characterization by Harris Semiconductor and is for use as application and design aid only. These characteristics are not 100% tested and no product guarantee is implied.

**Typical Performance Curves** Unless Otherwise Specified:  $T_A = +25^\circ\text{C}$ ,  $V_{\text{SUPPLY}} = \pm 15\text{V}$

**INPUT BIAS CURRENT AND OFFSET CURRENT AS A FUNCTION OF TEMPERATURE**

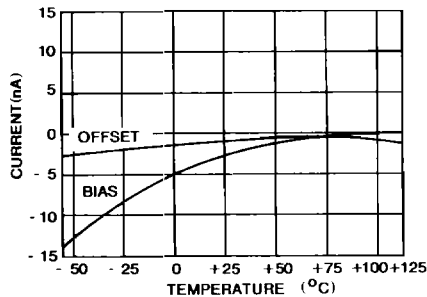

**EQUIVALENT INPUT NOISE vs. BANDWIDTH**

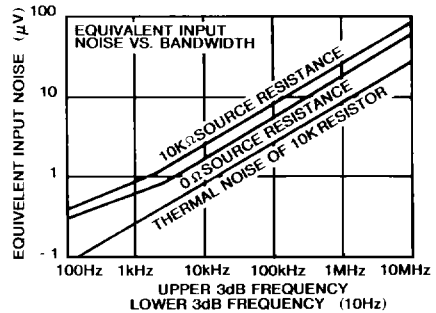

**OPEN LOOP FREQUENCY AND PHASE RESPONSE**

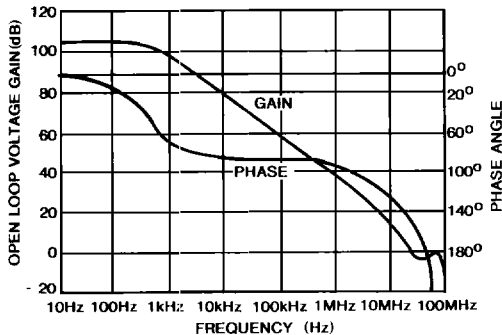

**INPUT IMPEDANCE vs. TEMPERATURES, 100Hz**

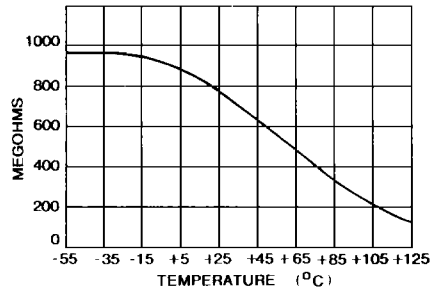

**OUTPUT VOLTAGE SWING vs. FREQUENCY**

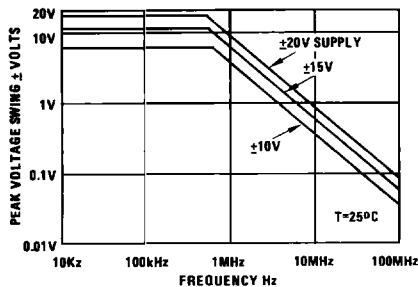

**OPEN LOOP FREQUENCY RESPONSE FOR VARIOUS VALUES OF CAPACITORS FROM COMPENSATION PIN TO GROUND**

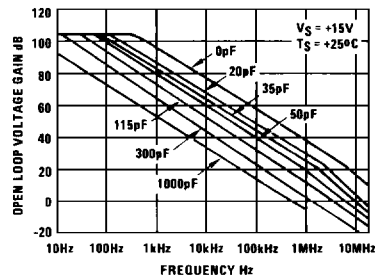

NOTE: External compensation components is required for Closed Loop Gain  $\leq 5$ . If external compensation is used, also connect 100pF Capacitor from output to ground for H.F. filtering.

**DESIGN INFORMATION** (Continued)

The information contained in this section has been developed through characterization by Harris Semiconductor and is for use as application and design aid only. These characteristics are not 100% tested and no product guarantee is implied.

**Typical Performance Curves** Unless Otherwise Specified:  $T_A = +25^\circ\text{C}$ ,  $V_{\text{SUPPLY}} = \pm 15\text{V}$

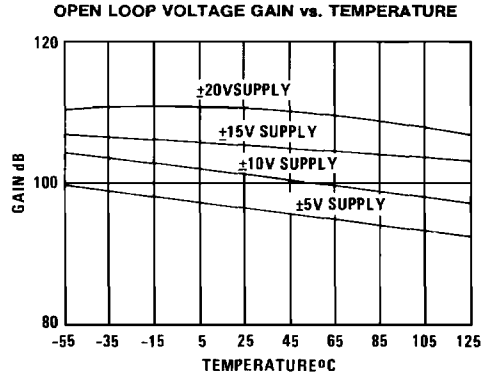
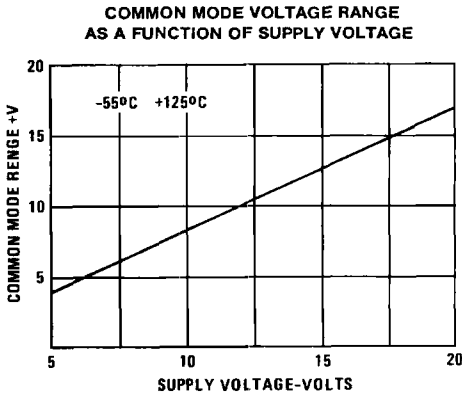

**HIGH IMPEDANCE COMPARATOR**

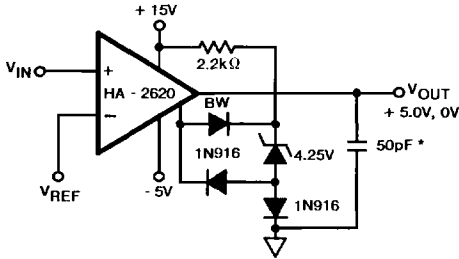

**VIDEO AMPLIFIER**

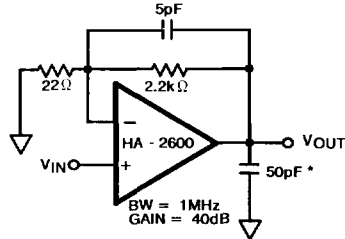

\* A small load capacitance of at least 30pF (including stray capacitance) is recommended to prevent high frequency oscillations.

**SUGGESTED  $V_{OS}$  ADJUSTMENT AND COMPENSATION HOOK-UP**

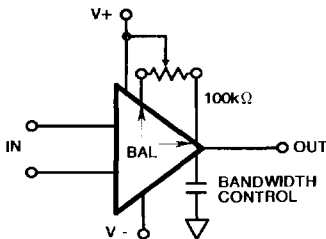

**FUNCTION GENERATOR**

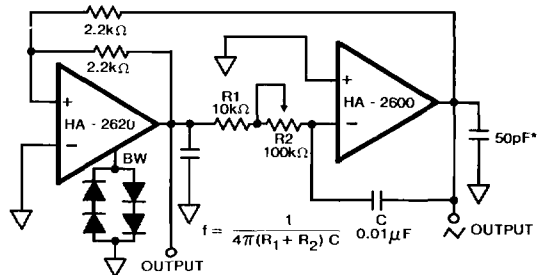

**DESIGN INFORMATION** (Continued)

The information contained in this section has been developed through characterization by Harris Semiconductor and is for use as application and design aid only. These characteristics are not 100% tested and no product guarantee is implied.

**TYPICAL PERFORMANCE CHARACTERISTICS**

Device Characterized at:  $V_S = \pm 15V$ ,  $R_L = 2K$ ,  $C_L = 50pF$ ,  $A_V \leq 5$ , Unless Otherwise Specified.

PARAMETERS	CONDITIONS	TEMP	HA-2620	HA-2622	DESIGN LIMIT	UNITS
			TYPICAL	TYPICAL		
Offset Voltage	$V_{CM} = 0V$	+25°C	0.5	3	Table 1	mV
		Full	2	4	Table 1	mV
Offset Voltage Average Drift	Versus Temperature	Full	5	5	15	$\mu V/^\circ C$
Offset Current Average Drift	Versus Temperature	Full	100	100	200	$pA/^\circ C$
Differential Input Resistance		+25°C	500	300	Table 3	$M\Omega$
Input Noise Voltage Density	$f_o = 10Hz$	+25°C	45	45	60	$nV/\sqrt{Hz}$
	$f_o = 100Hz$	+25°C	25	25	40	$nV/\sqrt{Hz}$
	$f_o = 1kHz$ to 100kHz	+25°C	15	15	Table 3	$nV/\sqrt{Hz}$
Input Noise Current Density	$f_o = 10Hz$	+25°C	1	1	2	$pA/\sqrt{Hz}$
	$f_o = 100Hz$	+25°C	0.25	0.25	0.5	$pA/\sqrt{Hz}$
	$f_o = 1kHz$ to 100kHz	+25°C	0.16	0.16	0.3	$pA/\sqrt{Hz}$
Output Voltage Swing	$R_L = 2k\Omega$	Full	$\pm 12$	$\pm 12$	Table 1	V
Large Signal Voltage Gain	$V_{OUT} = \pm 10V$	+25°C	150	150	Table 1	kV/V
CMRR	$V_{CM} = \pm 10V$	Full	100	100	Table 1	dB
PSRR	$\Delta V_{Supply} = \pm 10V$	Full	90	90	Table 1	dB
Gain Bandwidth Product (Small Signal)	$f_o = 10kHz$ , $C_{COMP} = 0pF$	+25°C	100	100	80	MHz
	$f_o = 1MHz$ , $C_{COMP} = 0pF$	+25°C	100	100	60	MHz
Rise/Fall Time	$V_{OUT} = \pm 200mV$	+25°C	17	17	Table 2	ns
Overshoot	$V_{OUT} = \pm 200mV$	+25°C	35	35	Table 2	%
Slew Rate	$V_{OUT} = \pm 10V$	+25°C	$\pm 35$	$\pm 35$	Table 2	$V/\mu s$
Full Power Bandwidth	$V_{PEAK} = 10V$ , (Note 2)	+25°C	600	600	Table 3	kHz
Settling Time	10V Step to 0.1%	+25°C	1	1	2	$\mu s$
Output Resistance	Open Loop	+25°C	30	30	65	$\Omega$
Minimum Supply Voltage	Functional Operation Only. Other Parameters Will Vary.	+25°C	$\pm 7$	$\pm 7$	$\pm 8V$	V

**3**  
 OP AMPs & COMPARATORS