

## LP8556 High-Efficiency LED Backlight Driver For Tablets

### 1 Features

- High-efficiency DC/DC boost converter with integrated 0.19-Ω power MOSFET and three switching frequency options: 312 kHz, 625 kHz, and 1250 kHz
- 2.7-V to 36-V Boost switch input voltage range supports multi-cell Li-Ion batteries (2.7-V to 20-V  $V_{DD}$  input range)
- 7-V to 43-V Boost switch output voltage range supports as few as 3 WLEDs in series per channel and as many as 12
- Configurable channel count (1 to 6)
- Up to 50 mA per channel
- PWM and / or I<sup>2</sup>C brightness control
- Phase-shift PWM mode reduces audible noise
- Adaptive dimming for higher LED drive optical efficiency
- Programmable edge-rate control and spread spectrum scheme minimize switching noise and improve EMI performance
- LED fault (short and open) detection, UVLO, TSD, OCP, and OVP (up to 6 threshold options)
- Available in tiny 20-pin, 0.4-mm pitch DSBGA package and 24-pin, 0.5-mm pitch WQFN package

### 2 Applications

LED backlights for tablet LCDs

### 3 Description

The LP8556 device is a white-LED driver featuring an asynchronous boost converter and six high precision current sinks that can be controlled by a PWM signal or an I<sup>2</sup>C master.

The boost converter uses adaptive output voltage control for setting the optimal LED driver voltages as low as 7 V and as high as 43 V. This feature minimizes the power consumption by adjusting the output voltage to the lowest sufficient level under all conditions. The converter can operate at three switching frequencies: 312 kHz, 625 kHz, and 1250 kHz, which can be set with an external resistor or pre-configured via EPROM. Programmable slew rate control and spread spectrum scheme minimize switching noise and improve EMI performance.

LED current sinks can be set with the PWM dimming resolution of up to 15 bits. Proprietary adaptive dimming mode allows higher system power saving. In addition, phase shifted LED PWM dimming allows reduced audible noise and smaller boost output capacitors.

The LP8556 device has a full set of fault-protection features that ensure robust operation of the device and external components. The set consists of input undervoltage lockout (UVLO), thermal shutdown (TSD), overcurrent protection (OCP), up to 6 levels of overvoltage protection (OVP), LED open and short detection.

The LP8556 device operates over the ambient temperature range of -30°C to +85°C. It is available in space-saving 20-pin DSBGA and 24-pad WQFN packages.

Simplified Schematic

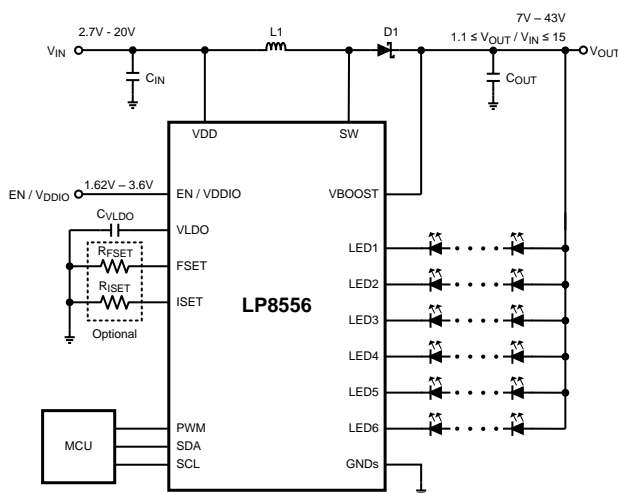

Device Information<sup>(1)</sup>

PART NUMBER	PACKAGE	BODY SIZE
LP8556	DSBGA (20)	2.401 mm × 1.74 mm (MAX)
	WQFN (24)	4.00 mm × 4.00 mm (NOM)

(1) For all available packages, see the orderable addendum at the end of the data sheet.



## Table of Contents

<b>1 Features</b> .....	<b>1</b>	8.2 Functional Block Diagram .....	<b>12</b>
<b>2 Applications</b> .....	<b>1</b>	8.3 Feature Description .....	<b>13</b>
<b>3 Description</b> .....	<b>1</b>	8.4 Device Functional Modes .....	<b>28</b>
<b>4 Revision History</b> .....	<b>2</b>	8.5 Programming .....	<b>28</b>
<b>5 Device Options</b> .....	<b>3</b>	8.6 Register Maps .....	<b>32</b>
<b>6 Pin Configuration and Functions</b> .....	<b>4</b>	<b>9 Application and Implementation</b> .....	<b>45</b>
<b>7 Specifications</b> .....	<b>6</b>	9.1 Application Information .....	<b>45</b>
7.1 Absolute Maximum Ratings .....	<b>6</b>	9.2 Typical Application .....	<b>47</b>
7.2 ESD Ratings .....	<b>6</b>	<b>10 Power Supply Recommendations</b> .....	<b>51</b>
7.3 Recommended Operating Conditions .....	<b>6</b>	<b>11 Layout</b> .....	<b>51</b>
7.4 Thermal Information .....	<b>7</b>	11.1 Layout Guidelines .....	<b>51</b>
7.5 Electrical Characteristics .....	<b>7</b>	11.2 Layout Examples .....	<b>52</b>
7.6 Electrical Characteristics — Boost Converter .....	<b>8</b>	<b>12 Device and Documentation Support</b> .....	<b>54</b>
7.7 Electrical Characteristics — LED Driver .....	<b>9</b>	12.1 Receiving Notification of Documentation Updates .....	<b>54</b>
7.8 Electrical Characteristics — PWM Interface .....	<b>9</b>	12.2 Community Resources .....	<b>54</b>
7.9 Electrical Characteristics — Logic Interface .....	<b>10</b>	12.3 Trademarks .....	<b>54</b>
7.10 I <sup>2</sup> C Serial Bus Timing Parameters (SDA, SCL) ....	<b>10</b>	12.4 Electrostatic Discharge Caution .....	<b>54</b>
7.11 Typical Characteristics .....	<b>11</b>	12.5 Glossary .....	<b>54</b>
<b>8 Detailed Description</b> .....	<b>12</b>	<b>13 Mechanical, Packaging, and Orderable Information</b> .....	<b>54</b>
8.1 Overview .....	<b>12</b>		

## 4 Revision History

<b>Changes from Revision K (March 2019) to Revision L</b>	<b>Page</b>
• Deleted 03H register from <a href="#">Table 9</a> .....	<b>32</b>
• Deleted 8.6.1.4 Identification section from the <a href="#">Register Bit Explanations</a> .....	<b>33</b>

<b>Changes from Revision J (January 2018) to Revision K</b>	<b>Page</b>
• Added separate ESD Rating for the WQFN package - changed from "±2000" to "±1000" .....	<b>6</b>

<b>Changes from Revision I (March 2016) to Revision J</b>	<b>Page</b>
• Added content in VBOOST_RANGE description of <a href="#">CFG9E</a> .....	<b>38</b>

<b>Changes from Revision H (December 2014) to Revision I</b>	<b>Page</b>
• Changed "25 mA" to "23 mA" - E00, E08 and E09 SQ rows, E09, E11 TME rows .....	<b>3</b>
• Changed <i>Handing Ratings</i> table to <i>ESD Ratings</i> .....	<b>6</b>
• Added updated <i>Thermal Information</i> .....	<b>7</b>
• Changed "8" to "10" in PWMres row .....	<b>9</b>
• Changed subtracted 1 from bit value of all Table 4 " $f_{PWM}$ [Hz] (Resolution)" entries .....	<b>20</b>
• Changed subtracted 1 from bit value of all Table 5 " $f_{PWM}$ [Hz] (Resolution)" entries except 2402 .....	<b>21</b>
• Changed subtracted 1 from bit value of all Table 11 " $f_{PWM}$ [Hz] (Resolution)" entries .....	<b>45</b>
• Changed "via EPROM" in Table 13 title to "With an External Resistor" .....	<b>46</b>
• Changed subtracted 1 from bit values of all Table 13 " $f_{PWM}$ [Hz] (Resolution)" entries except 2402 .....	<b>46</b>

**Changes from Revision G (November 2013) to Revision H**
**Page**

- Added *Pin Configuration and Functions* section, *Handling Ratings* table, *Feature Description* section, *Device Functional Modes*, *Application and Implementation* section, *Power Supply Recommendations* section, *Layout* section, *Device and Documentation Support* section, and *Mechanical, Packaging, and Orderable Information* section ..... **1**

**Changes from Revision E (August 2013) to Revision G**
**Page**

- Changed Description of "1=" for OCP row in Fault table, STATUS Register Section..... **34**
- Changed A7h values for E02, E03, E04, E06, E07, E09, E11 DSGBA EPROM Bit Explanations tables ..... **36**
- Deleted E00, E01, E08, E10, E12, E13 columns and A8H row from 3 EPROM Bit Explanations table..... **36**
- Changed values for E00, E08, E09 WQFN EPROM Settings table..... **37**

## 5 Device Options

ORDERABLE DEVICE <sup>(1)</sup>	PACKAGE TYPE	DEVICE OPTION	LED CHANNEL COUNT	MAXIMUM LED CURRENT	BOOST OUTPUT VOLTAGE RANGE
LP8556SQ-E00/NOPB LP8556SQE-E00/NOPB LP8556SQX-E00/NOPB	WQFN	"PWM Only" – Recommended for systems without an I <sup>2</sup> C master.	5	23 mA	16 V to 34.5 V
LP8556SQ-E08/NOPB LP8556SQE-E08/NOPB LP8556SQX-E08/NOPB			4		
LP8556SQ-E09/NOPB LP8556SQE-E09/NOPB LP8556SQX-E09/NOPB			6		
LP8556TME-E02/NOPB LP8556TMX-E02/NOPB	DSBGA	"PWM and I <sup>2</sup> C" - Recommended for systems with an I <sup>2</sup> C master.	6	25 mA	16 V to 30 V
LP8556TME-E03/NOPB LP8556TMX-E03/NOPB		"PWM Only" – Recommended for systems without an I <sup>2</sup> C master.	5	20 mA	16 V to 34.5 V
LP8556TME-E04/NOPB LP8556TMX-E04/NOPB			6	20 mA	16 V to 25 V
LP8556TME-E05/NOPB LP8556TMX-E05/NOPB		"Non-programmed" – This option is for evaluation purposes only.	Can be programmed to any available.	25 mA	Can be programmed to any available.
LP8556TME-E06/NOPB LP8556TMX-E06/NOPB		"PWM Only" – Recommended for systems without an I <sup>2</sup> C master.	5	25 mA	16 V to 39 V
LP8556TME-E07/NOPB LP8556TMX-E07/NOPB			4	20 mA	12.88 V to 30 V
LP8556TME-E09/NOPB LP8556TMX-E09/NOPB			6	23 mA	16 V to 34.5 V
LP8556TME-E11/NOPB LP8556TMX-E11/NOPB			"PWM and I <sup>2</sup> C" - Recommended for systems with an I <sup>2</sup> C master.	3	23 mA

(1) For the most current package and ordering information, see the *Package Option Addendum* at the end of this document, or see the TI website at [www.ti.com](http://www.ti.com).



### Pin Functions

PIN			TYPE <sup>(1)</sup>	DESCRIPTION
DSBGA	WQFN	NAME		
A1, B1	1, 2	SW	A	A connection to the drain terminal of the integrated power MOSFET.
A2, B2	3, 4	GND_SW	G	A connection to the source terminal of the integrated power MOSFET.
A3	5	SDA	I/O	I <sup>2</sup> C data input/output pin
A4	6	SCL	I	I <sup>2</sup> C clock input pin
B3	9	PWM	I	PWM dimming input. Supply a 75-Hz to 25-kHz PWM signal to control dimming. This pin must be connected to GND if unused.
B4	7	EN / VDDIO	P	Dual-purpose pin serving both as a chip enable and as a power supply reference for PWM, SDA, and SCL inputs. Drive this pin with a logic gate capable of sourcing a minimum of 1 mA.
C1	22	VDD	P	Device power supply pin. Provide 2.7-V to 20-V supply to this pin. This pin is an input of the internal LDO regulator. The output of the internal LDO is what powers the device.
C2	20	VBOOST	A	Boost converter output pin. The internal feedback (FB) and overvoltage protection (OVP) circuitry monitors the voltage on this pin. Connect the converter output capacitor bank close to this pin.
C3	21	FSET	A	A connection for setting the boost frequency and PWM output dimming frequency by using an external resistor. Connect a resistor, R <sub>FSET</sub> , between this pin and the ground reference (see <a href="#">Table 5</a> ). This pin may be left floating if PWM_FSET_EN = 0 AND BOOST_FSET_EN = 0 (see <a href="#">Table 10</a> ).
C4	14	LED3	A	LED driver - current sink terminal. If unused, it may be left floating.
D1	19	VLDO	P	Internal LDO output pin. Connect a capacitor, C <sub>VLDO</sub> , between this pin and the ground reference.
D2	23	ISET	A	A connection for the LED current set resistor. Connect a resistor, R <sub>ISET</sub> , between this pin and the ground reference. This pin may be left floating if ISET_EN = 0 (see <a href="#">Table 10</a> ).
D3	10, 11, 15, 24, DAP	GND	I	Ground pin.
D4	13	LED2	A	LED driver - current sink pin. If unused, it may be left floating.
E1	18	LED6	A	LED driver - current sink pin. If unused, it may be left floating.
E2	17	LED5	A	LED driver - current sink pin. If unused, it may be left floating.
E3	16	LED4	A	LED driver - current sink pin. If unused, it may be left floating.
E4	12	LED1	A	LED driver - current sink pin. If unused, it may be left floating.
—	8	NC	—	No Connect pin.

(1) A: Analog Pin, G: Ground Pin, P: Power Pin, I: Digital Input Pin, I/O: Digital Input/Output Pin

## 7 Specifications

### 7.1 Absolute Maximum Ratings

over operating free-air temperature range (unless otherwise noted)<sup>(1)(2)</sup>

	MIN	MAX	UNIT
V <sub>DD</sub>	-0.3	24	V
Voltage on Logic Pins (SCL, SDA, PWM)	-0.3	6	
Voltage on Analog Pins (VLDO, EN / VDDIO)	-0.3	6	
Voltage on Analog Pins (FSET, ISET)	-0.3	VLDO + 0.3	
V (LED1...LED6, SW, VBOOST)	-0.3	50	
Junction Temperature (T <sub>J-MAX</sub> ) <sup>(3)</sup>		125	°C
Maximum Lead Temperature (Soldering)		260	°C
Storage temperature, T <sub>stg</sub>	-65	150	°C

- (1) Stresses beyond those listed under *Absolute Maximum Ratings* may cause permanent damage to the device. These are stress ratings only, and functional operation of the device at these or any other conditions beyond those indicated under *Recommended Operating Conditions* is not implied. Exposure to absolute-maximum-rated conditions for extended periods may affect device reliability, see the *Electrical Characteristics* tables.
- (2) If Military/Aerospace specified devices are required, contact the Texas Instruments Sales Office/ Distributors for availability and specifications.
- (3) In applications where high power dissipation and/or poor package thermal resistance is present, the maximum ambient temperature may have to be de-rated. Maximum ambient temperature (T<sub>A-MAX</sub>) is dependent on the maximum operating junction temperature (T<sub>J-MAX-OP</sub> = 125°C), the maximum power dissipation of the device in the application (P<sub>D-MAX</sub>), and the junction-to ambient thermal resistance of the part/package in the application (R<sub>θJA</sub>), as given by the following equation: T<sub>A-MAX</sub> = T<sub>J-MAX-OP</sub> - (R<sub>θJA</sub> × P<sub>D-MAX</sub>).

### 7.2 ESD Ratings

		VALUE	UNIT
V <sub>(ESD)</sub>	Electrostatic discharge	Human-body model (HBM), per ANSI/ESDA/JEDEC JS-001, DSBGA Package <sup>(1)</sup>	±2000
		Human-body model (HBM), per ANSI/ESDA/JEDEC JS-001, WQFN Package <sup>(1)</sup>	±1000
		Charged-device model (CDM), per JEDEC specification JESD22-C101 <sup>(2)</sup>	±500

- (1) JEDEC document JEP155 states that 500-V HBM allows safe manufacturing with a standard ESD control process.
- (2) JEDEC document JEP157 states that 250-V CDM allows safe manufacturing with a standard ESD control process.

### 7.3 Recommended Operating Conditions

over operating free-air temperature range (unless otherwise noted)<sup>(1)</sup>

	MIN	MAX	UNIT
VDD	2.7	20	V
EN / VDDIO	1.62	3.6	V
V (LED1...LED6, SW, VBOOST)	0	48	V
Junction temperature, T <sub>J</sub>	-30	125	°C
Ambient temperature, T <sub>A</sub>	-30	85	°C

- (1) All voltages are with respect to the potential at the GND pins.

## 7.4 Thermal Information

THERMAL METRIC <sup>(1)</sup>		LP8556		UNIT
		YFQ (DSBGA)	RTW (WQFN)	
		20 PINS	24 PINS	
$R_{\theta JA}$	Junction-to-ambient thermal resistance	66.2	35.0	°C/W
$R_{\theta JC(top)}$	Junction-to-case (top) thermal resistance	0.5	32.2	°C/W
$R_{\theta JB}$	Junction-to-board thermal resistance	15.1	13.7	°C/W
$\psi_{JT}$	Junction-to-top characterization parameter	1.9	0.3	°C/W
$\psi_{JB}$	Junction-to-board characterization parameter	15.0	13.8	°C/W
$R_{\theta JC(bot)}$	Junction-to-case (bottom) thermal resistance	n/a	3.3	°C/W

(1) For more information about traditional and new thermal metrics, see the *Semiconductor and IC Package Thermal Metrics* application report (SPRA953).

## 7.5 Electrical Characteristics

Unless otherwise specified:  $V_{DD} = 12\text{ V}$ ,  $EN / V_{DDIO} = 1.8\text{ V}$ ,  $T_A = 25^\circ\text{C}$ <sup>(1)(2)</sup>

PARAMETER		TEST CONDITIONS	MIN	TYP	MAX	UNIT
$V_{DDIO}$	Supply voltage for digital I/Os		1.62		3.6	V
$V_{DD}$	Input voltage for the internal LDO		2.7		20	V
$I_{DD}$	Standby supply current	EN / VDDIO = 0 V, LDO disabled, $-30^\circ\text{C} \leq T_A \leq 85^\circ\text{C}$			1.6	$\mu\text{A}$
	Normal mode supply current	LDO enabled, boost disabled		0.9	1.5	mA
		LDO enabled, boost enabled, no load			2.2	
$f_{OSC}$	Internal oscillator frequency accuracy		-4%		4%	
		$-30^\circ\text{C} \leq T_A \leq 85^\circ\text{C}$	-7%		7%	
$V_{LDO}$	LDO output voltage	$V_{DD} \geq 3.1\text{ V}$	2.95	3.05	3.15	V
		$2.7\text{ V} \leq V_{DD} < 3.1\text{ V}$	$V_{DD} - 0.05$			
$T_{TSD}$	Thermal shutdown threshold	See <sup>(3)</sup>		150		°C
$T_{TSD\_hyst}$	Thermal shutdown hysteresis			20		°C

(1) All voltages are with respect to the potential at the GND pins.

(2) Minimum (MIN) and Maximum (MAX) limits are verified by design, test, or statistical analysis. Typical numbers are for information only.

(3) Verified by design and not tested in production.

## 7.6 Electrical Characteristics — Boost Converter

over operating free-air temperature range (unless otherwise noted)<sup>(1)</sup>

PARAMETER		TEST CONDITIONS		MIN	TYP	MAX	UNIT
R <sub>DS_ON</sub>	Switch ON resistance	I <sub>SW</sub> = 0.5A		0.19			Ω
V <sub>BOOST_MIN</sub>	Boost minimum output voltage	VBOOST_RANGE = 0 VBOOST_RANGE = 1		7 16			V
V <sub>BOOST_MAX</sub>	Boost maximum output voltage	VBOOST_MAX = 100, VBOOST_RANGE = 0		19	21	22	V
		VBOOST_MAX = 101, VBOOST_RANGE = 0		24.0	25	27	
		VBOOST_MAX = 110, VBOOST_RANGE = 0		28.0	30	32	
		VBOOST_MAX = 111, VBOOST_RANGE = 0		32	34	37	
		VBOOST_MAX = 010, VBOOST_RANGE = 1		17.9	21	23.1	V
		VBOOST_MAX = 011, VBOOST_RANGE = 1		22.8	25	27.2	
VBOOST_MAX = 100, VBOOST_RANGE = 1		27.8	30	31.5			
VBOOST_MAX = 101, VBOOST_RANGE = 1		32.7	34.5	36.6			
VBOOST_MAX = 110, VBOOST_RANGE = 1		37.2	39	40.8			
VBOOST_MAX = 111, VBOOST_RANGE = 1		41.8	43	44.2			
I <sub>LOAD_MAX</sub>	Maximum continuous output load current	V <sub>IN</sub> = 3 V, V <sub>OUT</sub> = 18 V		220			mA
		V <sub>IN</sub> = 3 V, V <sub>OUT</sub> = 24 V		160			
		V <sub>IN</sub> = 3 V, V <sub>OUT</sub> = 30 V		120			
V <sub>OUT</sub> /V <sub>IN</sub>	Conversion ratio <sup>(2)</sup>	f <sub>SW</sub> = 625 kHz					15
		f <sub>SW</sub> = 1250 kHz					12
f <sub>SW</sub>	Switching frequency	BOOST_FREQ = 00 BOOST_FREQ = 01 BOOST_FREQ = 10		312 625 1250			kHz
V <sub>OVP</sub>	Overvoltage protection voltage	VBOOST_RANGE = 1		V <sub>BOOST</sub> + 1.6			V
V <sub>UVLO</sub>	V <sub>IN</sub> undervoltage lockout threshold	UVLO_EN = 1					V
		UVLO_TH = 0, falling UVLO_TH = 1, falling		2.5 5.2			
V <sub>UVLO_hyst</sub>	V <sub>UVLO</sub> hysteresis	V <sub>UVLO</sub> [rising] V <sub>UVLO</sub> [falling]	UVLO_TH = 0 UVLO_TH = 1	50 100			mV
t <sub>PULSE</sub>	Switch minimum pulse width	No load		50			ns
t <sub>STARTUP</sub>	Start-up time	See <sup>(3)</sup>		8			ms
I <sub>SW_LIM</sub>	SW pin current limit <sup>(4)</sup>	IBOOST_LIM_2X = 0	IBOOST_LIM = 00	0.66	0.9	1.16	A
			IBOOST_LIM = 01	0.88	1.2	1.40	
			IBOOST_LIM = 10	1.12	1.5	1.73	
			IBOOST_LIM = 11	1.35	1.8	2.07	
		IBOOST_LIM_2X = 1	IBOOST_LIM = 00	1.6			A
			IBOOST_LIM = 01 IBOOST_LIM = 10	2.1 2.6			
ΔV <sub>SW</sub> / t <sub>off_on</sub>	SW pin slew rate during OFF to ON transition	EN_DRV3 = 0 AND EN_DRV2 = 0		3.7			V/ns
		EN_DRV3 = 0 AND EN_DRV2 = 1		5.3			
		EN_DRV3 = 1 AND EN_DRV2 = 1		7.5			
ΔV <sub>SW</sub> / t <sub>on_off</sub>	SW pin slew rate during ON to OFF transition	EN_DRV3 = 0 AND EN_DRV2 = 0		1.9			V/ns
		EN_DRV3 = 0 AND EN_DRV2 = 1		4.4			
		EN_DRV3 = 1 AND EN_DRV2 = 1		4.8			
Δt <sub>ON</sub> / t <sub>SW</sub>	Peak-to-peak switch ON time deviation to SW period ratio (spread spectrum feature)	SSCLK_EN = 1		1%			

(1) Minimum (MIN) and Maximum (MAX) limits are verified by design, test, or statistical analysis. Typical numbers are for information only.

(2) Verified by design and not tested in production.

(3) Start-up time is measured from the moment boost is activated until the V<sub>BOOST</sub> crosses 90% of its target value.

(4) 1.8 A is the maximum I<sub>SW\_LIM</sub> supported with the DSBGA package. For applications requiring the I<sub>SW\_LIM</sub> to be greater than 1.8 A and up to 2.6 A, WQFN package should be considered.



## 7.7 Electrical Characteristics — LED Driver

over operating free-air temperature range (unless otherwise noted)<sup>(1)</sup>

PARAMETER		TEST CONDITIONS	MIN	TYP	MAX	UNIT
$I_{LED\_LEAKAGE}$	Leakage current	Outputs LED1...LED6, $V_{OUT} = 48\text{ V}$		0.1	1	$\mu\text{A}$
$I_{LED\_MAX}$	Maximum sink current LED1...LED6			50		mA
$I_{LED}$	LED current accuracy <sup>(2)</sup>	Output current set to 23 mA	-3%	1%	3%	
		Output current set to 23 mA, $-30^{\circ}\text{C} \leq T_A \leq 85^{\circ}\text{C}$	-4%	1%	4%	
$I_{MATCH}$	Matching	Output current set to 23 mA		0.5%		
$PWM_{DUTY}$	LED PWM output pulse duty cycle <sup>(3)</sup>	$100\text{ Hz} < f_{PWM} \leq 200\text{ Hz}$	0.02%		100%	
		$200\text{ Hz} < f_{PWM} \leq 500\text{ Hz}$	0.02%		100%	
		$500\text{ Hz} < f_{PWM} \leq 1\text{ kHz}$	0.02%		100%	
		$1\text{ kHz} < f_{PWM} \leq 2\text{ kHz}$	0.04%		100%	
		$2\text{ kHz} < f_{PWM} \leq 5\text{ kHz}$	0.1%		100%	
		$5\text{ kHz} < f_{PWM} \leq 10\text{ kHz}$	0.2%		100%	
		$10\text{ kHz} < f_{PWM} \leq 20\text{ kHz}$	0.4%		100%	
		$20\text{ kHz} < f_{PWM} \leq 30\text{ kHz}$ $30\text{ kHz} < f_{PWM} \leq 39\text{ kHz}$	0.6% 0.8%		100%	
$f_{LED}$	PWM output frequency	$PWM\_FREQ = 1111$		38.5		kHz
$V_{SAT}$	Saturation voltage <sup>(4)</sup>	Output current set to 23 mA		200		mV

- (1) Minimum (MIN) and Maximum (MAX) limits are specified by design, test, or statistical analysis. Typical numbers are not verified, but do represent the most likely norm.
- (2) Output Current Accuracy is the difference between the actual value of the output current and programmed value of this current. Matching is the maximum difference from the average. For the constant current sinks on the part (OUT1 to OUT6), the following are determined: the maximum output current (MAX), the minimum output current (MIN), and the average output current of all outputs (AVG). Two matching numbers are calculated:  $(MAX-AVG)/AVG$  and  $(AVG-MIN)/AVG$ . The largest number of the two (worst case) is considered the matching figure. The typical specification provided is the most likely norm of the matching figure for all parts. Note that some manufacturers have different definitions in use.
- (3) Verified by design and not tested in production.
- (4) Saturation voltage is defined as the voltage when the LED current has dropped 10% from the value measured at 1 V.

## 7.8 Electrical Characteristics — PWM Interface<sup>(1)</sup>

PARAMETER		TEST CONDITIONS	MIN	TYP	MAX	UNIT
$f_{PWM}$	PWM frequency range <sup>(2)</sup>		75		25 000	Hz
$t_{MIN\_ON}$	Minimum pulse ON time			1		$\mu\text{s}$
$t_{MIN\_OFF}$	Minimum pulse OFF time			1		
$t_{STARTUP}$	Turnon delay from standby to backlight on	PWM input active, VDDIO pin transitions from 0 V to 1.8 V		10		ms
$t_{STBY}$	Turnoff delay	PWM input low time for turnoff		50		ms
$PWM_{RES}$	PWM input resolution	$f_{IN} < 9\text{ kHz}$		10		bits

- (1) Minimum (MIN) and Maximum (MAX) limits are specified by design, test, or statistical analysis. Typical numbers are for information only.
- (2) Verified by design and not tested in production.

### 7.9 Electrical Characteristics — Logic Interface <sup>(1)</sup>

PARAMETER		TEST CONDITIONS	MIN	TYP	MAX	UNIT
<b>LOGIC INPUTS (PWM, SDA, SCL)</b>						
V <sub>IL</sub>	Input low level	-30°C ≤ T <sub>A</sub> ≤ 85°C			0.3 × VDDIO	V
V <sub>IH</sub>	Input high level	-30°C ≤ T <sub>A</sub> ≤ 85°C	0.7 × VDDIO			V
I <sub>I</sub>	Input current	(V <sub>DDIO</sub> = 0 V or 3.6 V), (V <sub>I</sub> = 0 V or 3.6 V), -30°C ≤ T <sub>A</sub> ≤ 85°C	-1		1	μA
<b>LOGIC OUTPUTS (SDA)</b>						
V <sub>OL</sub>	Output low level	I <sub>OUT</sub> = 3 mA (pull-up current)		0.3		V
		I <sub>OUT</sub> = 3 mA (pull-up current), -30°C ≤ T <sub>A</sub> ≤ 85°C		0.3	0.4	
I <sub>L</sub>	Output leakage current	V <sub>OUT</sub> = 5 V, -30°C ≤ T <sub>A</sub> ≤ 85°C	-1		1	μA

(1) Minimum (MIN) and Maximum (MAX) limits are specified by design, test, or statistical analysis. Typical numbers are for information only.

### 7.10 I<sup>2</sup>C Serial Bus Timing Parameters (SDA, SCL)<sup>(1)</sup>

		MIN	MAX	UNIT
f <sub>SCL</sub>	Clock frequency		400	kHz
1	Hold time (repeated) START condition	0.6		μs
2	Clock low time	1.3		μs
3	Clock high time	600		ns
4	Setup time for a repeated START condition	600		ns
5	Data hold time	50		ns
6	Data set-up time	100		ns
7	Rise time of SDA and SCL	20 + 0.1C <sub>b</sub>	300	ns
8	Fall time of SDA and SCL	15 + 0.1C <sub>b</sub>	300	ns
9	Setup time for STOP condition	600		ns
10	Bus-free time between a STOP and a START condition	1.3		μs
C <sub>b</sub>	Capacitive load parameter for each bus line load of 1 pF corresponds to 1 ns.	10	200	ns

(1) Verified by design and not tested in production.

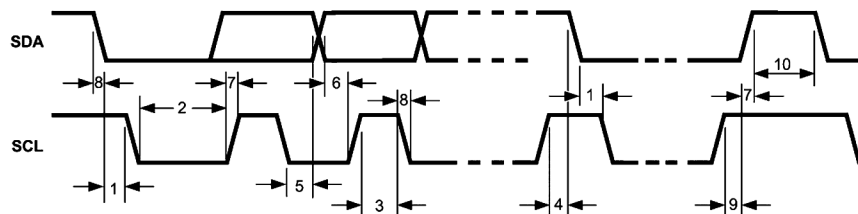
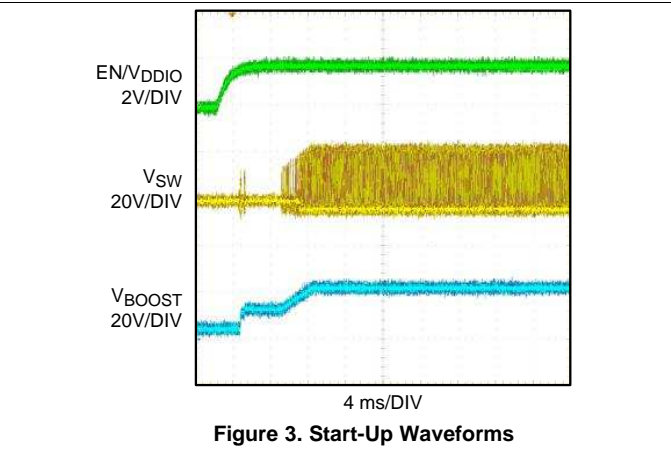
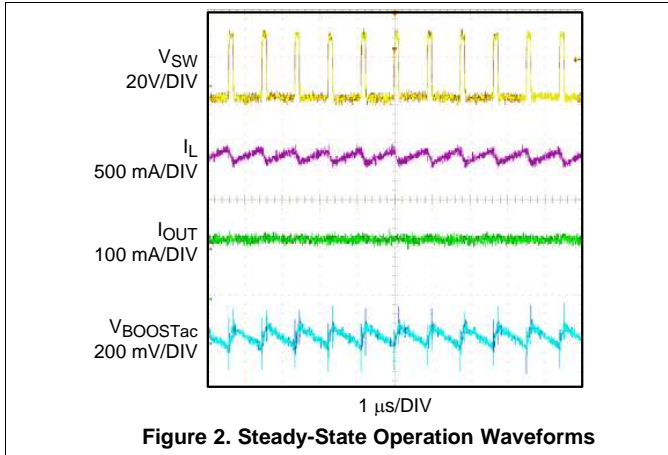

Figure 1. I<sup>2</sup>C-Compatible Timing

### 7.11 Typical Characteristics

Unless otherwise specified:  $V_{IN} = 3.8\text{ V}$ ,  $C_{VLDO} = 10\ \mu\text{F}$ ,  $L_1 = 4.7\ \mu\text{H}$ ,  $C_{IN} = 2.2\ \mu\text{F}$ ,  $C_{OUT} = 4.7\ \mu\text{F}$ ,  $f_{SW} = 1.25\ \text{MHz}$ .





## 8.3 Feature Description

### 8.3.1 Boost Converter

#### 8.3.1.1 Boost Converter Operation

The LP8556 boost DC-DC converter generates a 7-V to approximately 43-V of boost output voltage from a 2.7-V to 36-V boost input voltage. The boost output voltage minimum, maximum value and range can be set digitally by pre-configuring EPROM memory (VBOOST\_RANGE, VBOOST, and VBOOST\_MAX fields).

The converter is a magnetic switching PWM mode DC-DC boost converter with a current limit. It uses CPM (current programmed mode) control, where the inductor current is measured and controlled with the feedback. During start-up, the soft-start function reduces the peak inductor current. The LP8556 has an internal 20-MHz oscillator which is used for clocking the boost. Figure 4 shows the boost block diagram.

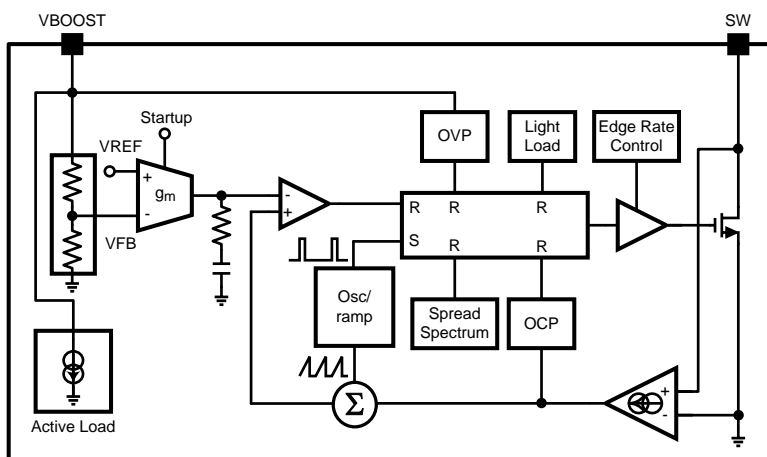

Figure 4. LP8556 Boost Converter Block Diagram

#### 8.3.1.2 Setting Boost Switching Frequency

The LP8556 boost converter switching frequency can be set either by an external resistor (BOOST\_FSET\_EN = 1 selection),  $R_{FSET}$ , or by pre-configuring EPROM memory with the choice of boost frequency (BOOST\_FREQ field). Table 1 summarizes setting of the switching frequency. Note that the  $R_{FSET}$  is shared for setting the PWM dimming frequency in addition to setting the boost switching frequency. Setting the boost switching frequency and PWM dimming frequency using an external resistor is separately shown in Table 5.

Table 1. Configuring Boost Switching Frequency via EPROM

$R_{FSET}$ [ $\Omega$ ]	BOOST_FSET_EN	BOOST_FREQ[1:0]	$f_{sw}$ [kHz]
don't care	0	00	312
don't care	0	01	625
don't care	0	10	1250
don't care	0	11	undefined
See <sup>(1)</sup>	1	don't care	See <sup>(1)</sup>

(1) See Table 5.

### 8.3.1.3 Output Voltage Control

The LP8556 device supports two modes of controlling the boost output voltage: Adaptive Boost Voltage Control (see [Adaptive Control](#)) and Manual Boost Output Control (see [Manual Control](#)).

#### 8.3.1.3.1 Adaptive Control

LP8556 supports a mode of output voltage control called Adaptive Boost Control mode. In this mode, the voltage at the LED pins is periodically monitored by the control loop and adaptively adjusted to the optimum value based on the comparator thresholds set using LED DRIVER\_HEADROOM, LED\_COMP\_HYST, BOOST\_STEP\_UP, BOOST\_STEP\_DOWN fields in the EPROM. Settings under LED DRIVER\_HEADROOM along with LED\_COMP\_HYST fields determine optimum boost voltage for a given condition. Boost voltage is raised if the voltage measured at any of the LED strings falls below the threshold setting determined with LED DRIVER\_HEADROOM field. Likewise, boost voltage is lowered if the voltage measured at any of the LED strings is above the combined setting determined under LED DRIVER\_HEADROOM and LED\_COMP\_HYST fields. LED\_COMP\_HYST field serves to fine tune the headroom voltage for a given peak LED current. The boost voltage up/down step size can be controlled with the BOOST\_STEP\_UP and BOOST\_STEP\_DN fields.

The initial boost voltage is configured with the VBOOST field. This field also sets the minimum boost voltage. The VBOOST\_MAX field sets the maximum boost voltage. When an LED pin is open, the monitored voltage never has enough headroom, and the adaptive mode control loop keeps raising the boost voltage. The VBOOST\_MAX field allows the boost voltage to be limited to stay under the voltage rating of the external components.

**NOTE**

Only LED strings that are enabled are monitored and PS\_MODE field determines which LED strings are enabled.

The adaptive mode is selected using ADAPTIVE bit set to 1 (CFG A EPROM Register) and is the recommended mode of boost control.

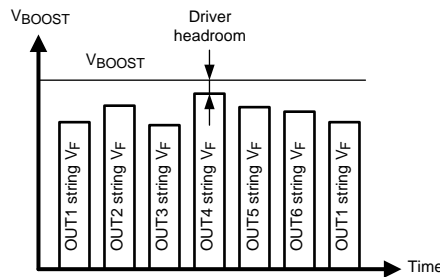

**Figure 5. Boost Adaptive Control Principle**

#### 8.3.1.3.2 Manual Control

User can control the boost output voltage with the VBOOST EPROM field when adaptive mode is not used. [Equation 1](#) shows the relationship between the boost output voltage and the VBOOST field.

$$V_{\text{BOOST}} = V_{\text{BOOST\_MIN}} + 0.42 \times V_{\text{BOOST}}[\text{dec}] \tag{1}$$

The expression is only valid when the calculated values are between the minimum boost output voltage and the maximum boost output voltage. The minimum boost output voltage is set with the VBOOST\_RANGE field. The maximum boost output voltage is set with the VBOOST\_MAX EPROM field.

### 8.3.1.4 EMI Reduction

The LP8556 device features two EMI reduction schemes.

The first scheme, Programmable Slew Rate Control, uses a combination of three drivers for boost switch. Enabling all three drivers allows boost switch on/off transition times to be the shortest. On the other hand, enabling just one driver allows boost switch on/off transition times to be the longest. The longer the transition times, the lower the switching noise on the SW pin. Note that the shortest transition times bring the best efficiency as the switching losses are the lowest.

EN\_DRV2 and EN\_DRV3 bits in the EPROM determine the boost switch driver configuration. Refer to the SW pin slew rate parameter listed under *Electrical Characteristics — Boost Converter* for the slew rate options.

The second EMI reduction scheme is the spread spectrum. This scheme deliberately spreads the frequency content of the boost switching waveform, which inherently has a narrow bandwidth, makes the bandwidth of the switching waveform wider, and ultimately reduces its EMI spectral density.

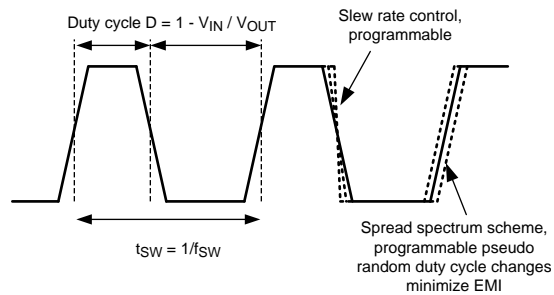

Figure 6. Principles of EMI Reduction Scheme

## 8.3.2 Brightness Control

LP8556 enables various methods of brightness control. The brightness can be controlled using an external PWM signal or the Brightness register accessible by users via an I<sup>2</sup>C interface or both. How these two input sources are selected and combined is set by the BRT\_MODE EPROM bits and described in *BRT\_MODE = 00* through *BRT\_MODE = 11*, Figure 7, and Table 2. The LP8556 can also be preconfigured via EPROM memory to allow direct and unaltered brightness control by an external PWM signal. This mode of operation is obtained by setting PWM\_DIRECT EPROM bit to 1 (CFG5[7] = 1).

### 8.3.2.1 BRT\_MODE = 00

With BRT\_MODE = 00, the LED output is controlled by the PWM input duty cycle. The PWM detector block measures the duty cycle at the PWM pin and uses this 16-bit value to generate an internal to the device PWM data. Before the output is generated, the PWM data goes through the PWM curve-shaper block. Then, the data goes into the adaptive dimming function which determines the range of the PWM and Current control as described in *Output Dimming Schemes*. The outcome of the adaptive dimming function is 12-bit current and/or up to 6 PWM output signals. The current is then passed through the non-linear compensation block while the output PWM signals are channeled through the dither block.

### 8.3.2.2 BRT\_MODE = 01

With BRT\_MODE = 01, the PWM output is controlled by the PWM input duty cycle and the Brightness register. The PWM detector block measures the duty cycle at the PWM pin and uses this 16-bit value to generate the PWM data. Before the output is generated, the PWM data is first multiplied with BRT[7:0] register, then it goes through the PWM Curve Shaper block. Then, the data goes into the Adaptive Dimming function which determines the range of the PWM and Current control as described in *Output Dimming Schemes*. The outcome of the Adaptive Dimming function is 12-bit current and/or up to 6 PWM output signals. The current is then passed through the non-linear compensation block while the output PWM signals are channeled through the Dither block.

### 8.3.2.3 BRT\_MODE = 10

With BRT\_MODE = 10, the PWM output is controlled only by the Brightness register. From BRT[7:0] register, the data goes through the PWM Curve Shaper block. Then, the data goes into the Adaptive Dimming function which determines the range of the PWM and Current control as described in [Output Dimming Schemes](#). The outcome of the Adaptive Dimming function is 12-bit Current and / or up to 6 PWM output signals. The current is then passed through the non-linear compensation block while the output PWM signals are channeled through the Dither block.

### 8.3.2.4 BRT\_MODE = 11

With BRT\_MODE = 11, the PWM control signal path is similar to the path when BRT\_MODE = 01 except that the PWM input signal is multiplied with BRT[7:0] data after the Curve-Shaper block.

**Table 2. Brightness Control Methods Truth Table**

PWM_DIRECT	BRT_MODE [1:0]	BRIGHTNESS CONTROL SOURCE	OUTPUT ILED FORM
0	00	External PWM signal	Adaptive. See <a href="#">Output Dimming Schemes</a>
0	01	External PWM signal and Brightness Register (multiplied before Curve Shaper)	
0	10	Brightness Register	
0	11	External PWM signal and Brightness Register (multiplied after Curve Shaper)	
1	don't care	External PWM signal	Same as the external PWM input



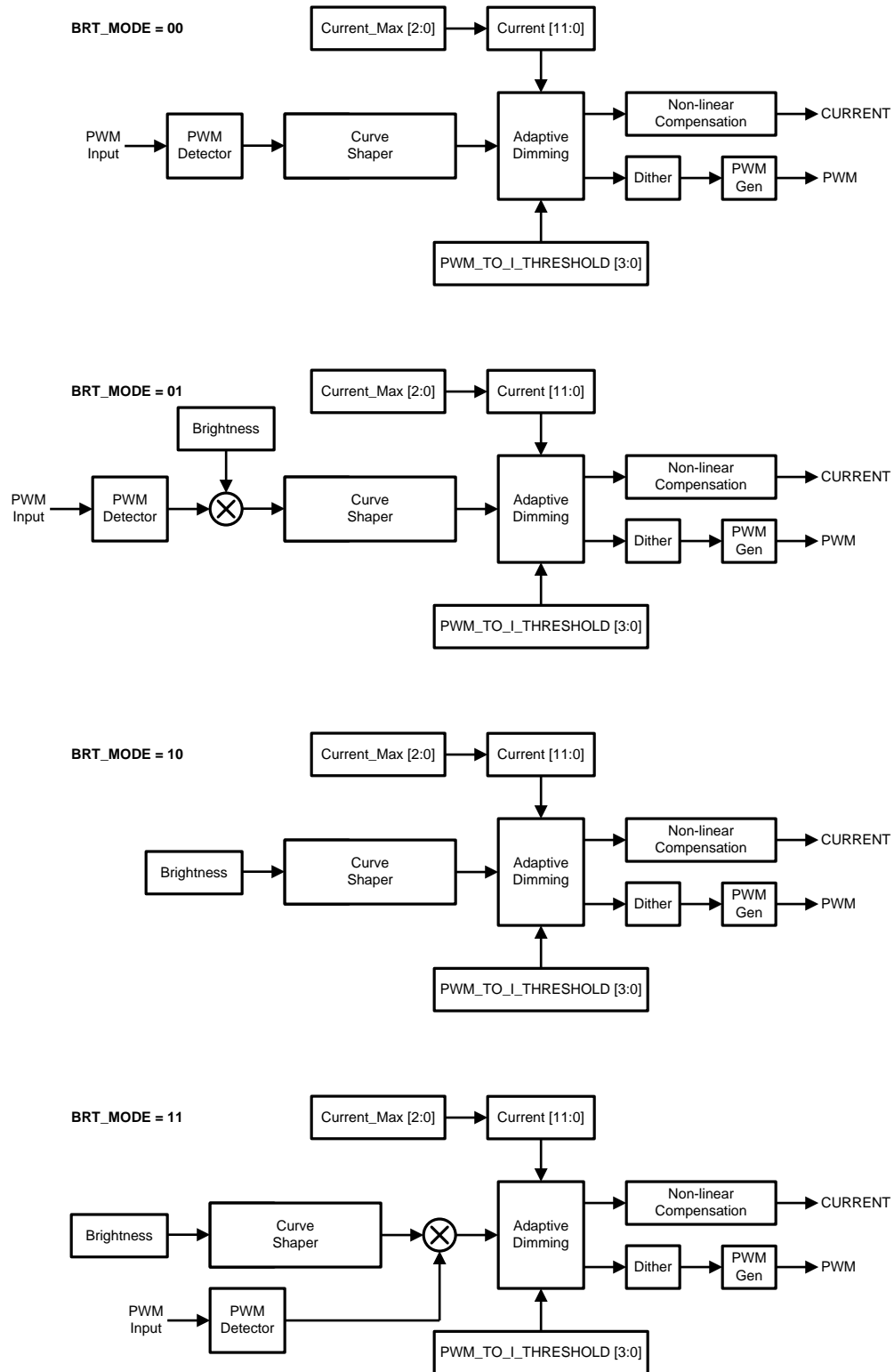

Figure 7. Brightness Control Signal Path Block Diagrams

### 8.3.2.5 Output Dimming Schemes

The LP8556 device supports three types of output dimming control methods: PWM Control, Pure Current Control and Adaptive Dimming (Hybrid PWM and Current) Control.

#### 8.3.2.5.1 PWM Control

PWM control is the traditional way of controlling the brightness using PWM of the outputs with the same LED current across the entire brightness range. Brightness control is achieved by varying the duty cycle proportional to the input PWM. PWM frequency is set either using an external set resistor ( $R_{FSET}$ ) or using the PWM\_FREQ EPROM field. The maximum LED current is set by using an external set Resistor ( $R_{ISET}$ ), CURRENT, and CURRENT\_MAX EPROM bits. PWM frequency can also be set by simply using the CURRENT and CURRENT\_MAX EPROM bits.

**NOTE**

The output PWM signal is de-coupled and generated independent of the input PWM signal eliminating display flicker issues and allowing better noise immunity.

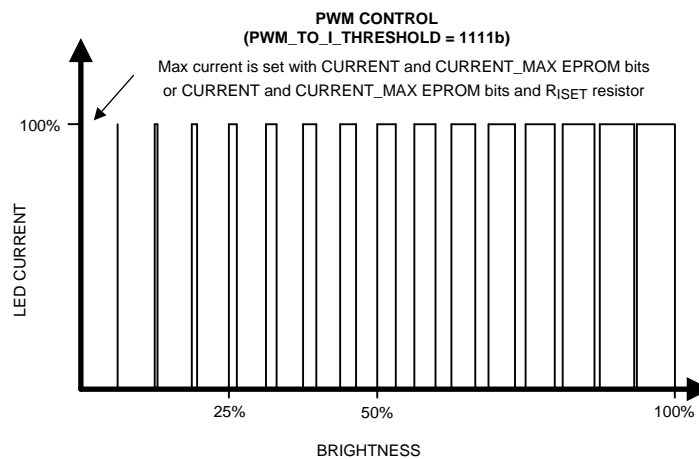

**Figure 8. PWM Only Output Dimming Scheme**

#### 8.3.2.5.2 Pure Current Control

In Pure Current Control mode, brightness control is achieved by changing the LED current proportionately from maximum value to a minimum value across the entire brightness range. Like in PWM Control mode, the maximum LED current is set by using an external set Resistor ( $R_{ISET}$ ), CURRENT, and CURRENT\_MAX EPROM bits. The maximum LED current can also be set by just using the CURRENT and CURRENT\_MAX EPROM bits. Current resolution in this mode is 12 bits.

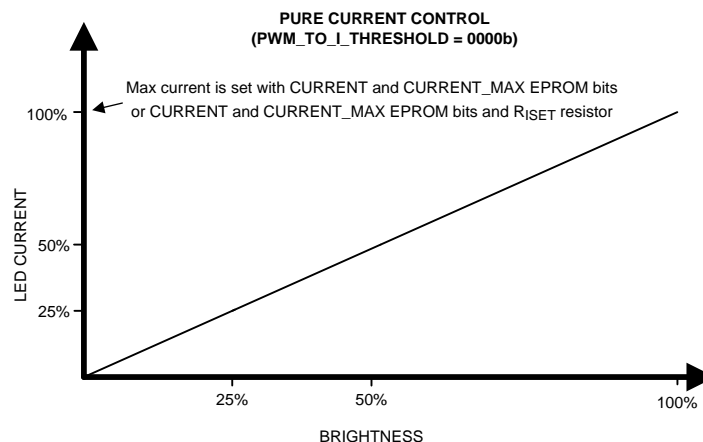

**Figure 9. Pure Current or Analog Output Dimming Scheme**

### 8.3.2.5.3 Adaptive Control

Adaptive dimming control combines PWM Control and Pure Current Control dimming methods. With the adaptive dimming, it is possible to achieve better optical efficiency from the LEDs compared to pure PWM control while still achieving smooth and accurate control at low brightness levels. Current resolution in this mode is 12 bits. Switch point from Current to PWM control can be set with the PWM\_TO\_I\_THRESHOLD EPROM field from 0% to 100% of the brightness range to get good compromise between good matching of the LEDs brightness/white point at low brightness and good optical efficiency.

PWM frequency is set either using an external set Resistor ( $R_{FSET}$ ) or using the PWM\_FREQ EPROM bits. The maximum LED current is set either by using an external set Resistor ( $R_{ISET}$ ), CURRENT, and CURRENT\_MAX EPROM bits. Or the maximum LED current may be set using the CURRENT and CURRENT\_MAX EPROM bits.

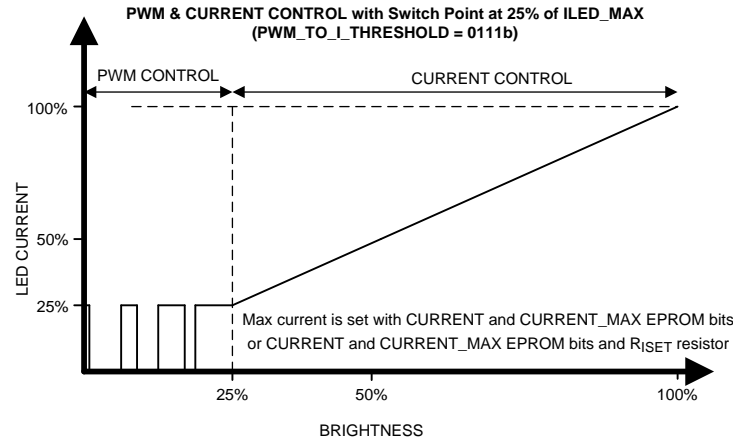

Figure 10. Adaptive Output Dimming Scheme

### 8.3.2.6 Setting Full-Scale LED Current

The maximum or full-scale LED current is set either using an external set Resistor ( $R_{ISET}$ ), CURRENT, and CURRENT\_MAX EPROM bits or just by using the CURRENT and CURRENT\_MAX EPROM bits. Table 3 summarizes setting of the full-scale LED current.

Table 3. Setting Full-Scale LED Current

$R_{ISET}$ [ $\Omega$ ]	ISET_EN	CURRENT_MAX	CURRENT[11:0]	FULL-SCALE ILED [mA]
don't care	0	000	FFFh	5
don't care	0	001	FFFh	10
don't care	0	010	FFFh	15
don't care	0	011	FFFh	20
don't care	0	100	FFFh	23
don't care	0	101	FFFh	25
don't care	0	110	FFFh	30
don't care	0	111	FFFh	50
don't care	0	000 - 111	001h - FFFh	See <sup>(1)</sup>
24k	1	000	FFFh	5
24k	1	001	FFFh	10
24k	1	010	FFFh	15
24k	1	011	FFFh	20
24k	1	100	FFFh	23
24k	1	101	FFFh	25
24k	1	110	FFFh	30
24k	1	111	FFFh	50
12k - 100k	1	000 - 111	001h - FFFh	See <sup>(1)</sup>

(1) See CFG0.

### 8.3.2.7 Setting PWM Dimming Frequency

LP8556 PWM dimming frequency can be set by an external resistor,  $R_{FSET}$ , or by pre-configuring EPROM Memory (CFG5 register, PWM\_FREQ[3:0] bits). [Table 4](#) summarizes setting of the PWM dimming frequency. Note that .

#### NOTE

The  $R_{FSET}$  is shared for setting the boost switching frequency, too. Setting the boost switching frequency and PWM dimming frequency using an external resistor is shown in [Table 5](#).

**Table 4. Configuring PWM Dimming Frequency via EPROM**

$R_{FSET}$ [k $\Omega$ ]	PWM_FSET_EN	PWM_FREQ[3:0]	$f_{PWM}$ [Hz] (Resolution)
don't care	0	0000	4808 (11-bit)
		0001	6010 (10-bit)
		0010	7212 (10-bit)
		0011	8414 (10-bit)
		0100	9616 (10-bit)
		0101	12020 (9-bit)
		0110	13222 (9-bit)
		0111	14424 (9-bit)
		1000	15626 (9-bit)
		1001	16828 (9-bit)
		1010	18030 (9-bit)
		1011	19232 ((9-bit)
		1100	24040 (8-bit)
		1101	28848 (8-bit)
		1110	33656 (8-bit)
1111	38464 (8-bit)		
See <sup>(1)</sup>	1	don't care	See <sup>(1)</sup>

(1) See [Table 5](#).

**Table 5. Setting Switching and PWM Dimming Frequency With an External Resistor**

$R_{FSET}$ [ $\Omega$ ] (Tolerance)	$f_{SW}$ [kHz]	$f_{PWM}$ [Hz] (Resolution)
Floating or FSET pin pulled HIGH	1250	9616 (10-bit)
470k - 1M ( $\pm 5\%$ )	312	2402 (12-bit)
300k, 330k ( $\pm 5\%$ )	312	4808 (11-bit)
200k ( $\pm 5\%$ )	312	6010 (10-bit)
147k, 150k, 154k, 158k ( $\pm 1\%$ )	312	9616 (10-bit)
121k ( $\pm 1\%$ )	312	12020 (9-bit)
100k ( $\pm 1\%$ )	312	14424 (9-bit)
86.6k ( $\pm 1\%$ )	312	16828 (9-bit)
75.0k ( $\pm 1\%$ )	312	19232 (9-bit)
63.4k ( $\pm 1\%$ )	625	2402 (12-bit)
52.3k, 53.6k ( $\pm 1\%$ )	625	4808 (11-bit)
44.2k, 45.3k ( $\pm 1\%$ )	625	6010 (10-bit)
39.2k ( $\pm 1\%$ )	625	9616 (10-bit)
34.0k ( $\pm 1\%$ )	625	12020 (9-bit)
30.1k ( $\pm 1\%$ )	625	14424 (9-bit)
26.1k ( $\pm 1\%$ )	625	16828 (9-bit)
23.2k ( $\pm 1\%$ )	625	19232 (9-bit)
20.5k ( $\pm 1\%$ )	1250	2402 (12-bit)
18.7k ( $\pm 1\%$ )	1250	4808 (11-bit)
16.5k ( $\pm 1\%$ )	1250	6010 (10-bit)
14.7k ( $\pm 1\%$ )	1250	9616 (10-bit)
13.0k ( $\pm 1\%$ )	1250	12020 (9-bit)
11.8k ( $\pm 1\%$ )	1250	14424 (9-bit)
10.7k ( $\pm 1\%$ )	1250	16828 (9-bit)
9.76k ( $\pm 1\%$ )	1250	19232 (9-bit)
FSET pin shorted to GND	1250	Same as PWM input

### 8.3.2.8 Phase Shift PWM Scheme

Phase shift PWM scheme allows delaying the time when each LED driver is active. When the LED drivers are not activated simultaneously, the peak load current from the boost output is greatly decreased. This reduces the ripple seen on the boost output and allows smaller output capacitors. Reduced ripple also reduces the output ceramic capacitor audible ringing. PSPWM scheme also increases the load frequency seen on the boost output six times and therefore transfers the possible audible noise to the frequencies outside of the audible range.

Description of the PSPWM mode is seen in [Table 6](#). PSPWM mode is set with <PS\_MODE[2:0]> bits.

**Table 6. LED String Configuration**

PS_MODE[2:0]	WAVEFORMS	CONNECTION
000		
6 LED strings with 60 degree phase shift. One driver for each LED string.		
001		
5 LED strings with 72 degree phase shift. One driver for each LED string. (Driver #6 not used).		

Table 6. LED String Configuration (continued)

PS_MODE[2:0]	WAVEFORMS	CONNECTION
010	<p>Phase Delay 90 degrees Cycle Time <math>1/(f_{PWM})</math></p>	<p>VBOOST</p> <p>4 LED strings with 90 degree phase shift. One driver for each LED string. (Drivers #5 and #6 not used).</p>
011	<p>Phase Delay 120 degrees Cycle Time <math>1/(f_{PWM})</math></p>	<p>VBOOST</p> <p>3 LED strings with 120 degree phase shift. One driver for each LED string. (Drivers #4, #5 and #6 not used).</p>
100	<p>Phase Delay 180 degrees Cycle Time <math>1/(f_{PWM})</math></p>	<p>VBOOST</p> <p>2 LED strings with 180 degree phase shift. One driver for each LED string. (Drivers #3, #4, #5 and #6 not used).</p>

**Table 6. LED String Configuration (continued)**

PS_MODE[2:0]	WAVEFORMS	CONNECTION
101		
<p>3 LED strings with 120 degree phase shift. Two drivers for each LED string. (Drivers 1&amp;2, 3&amp;4 and 5&amp;6 are tied and with the same phase).</p>		
110		
<p>2 LED strings with 180 degree phase shift. Three drivers for each LED string. (Drivers 1&amp;2&amp;3 and 4&amp;5&amp;6 are tied and with the same phase).</p>		



Table 6. LED String Configuration (continued)

PS_MODE[2:0]	WAVEFORMS	CONNECTION
111		
<p>1 LED string driven by all six drivers. (All drivers are tied and with the same phase).</p>		

### 8.3.2.9 Slope and Advanced Slope

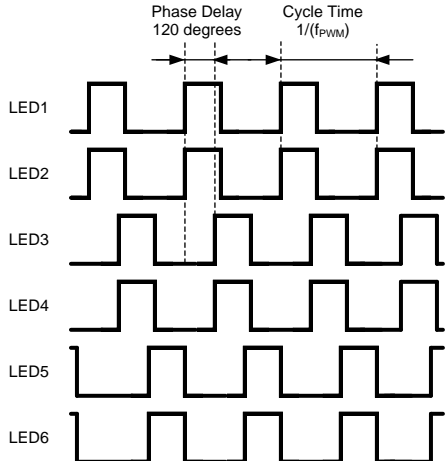
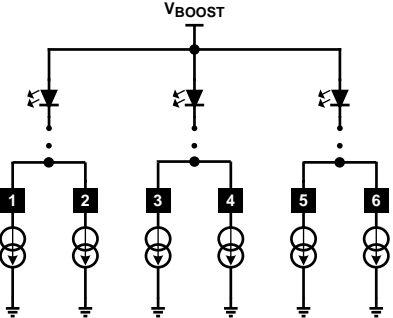
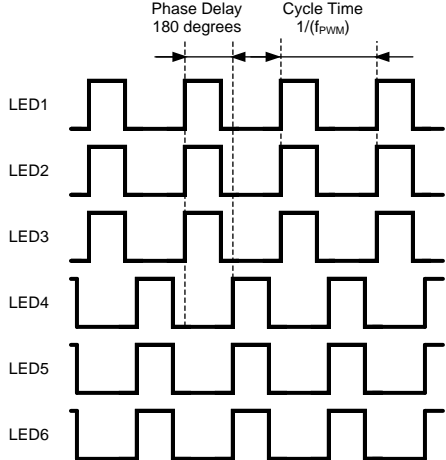
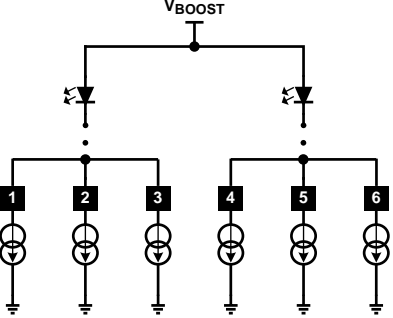
Transition time between two brightness values can be programmed with EPROM bits <PWM\_SLOPE[2:0]> from 0 to 500 ms. Same slope time is used for sloping up and down. With advanced slope the brightness changes can be made more pleasing to a human eye.

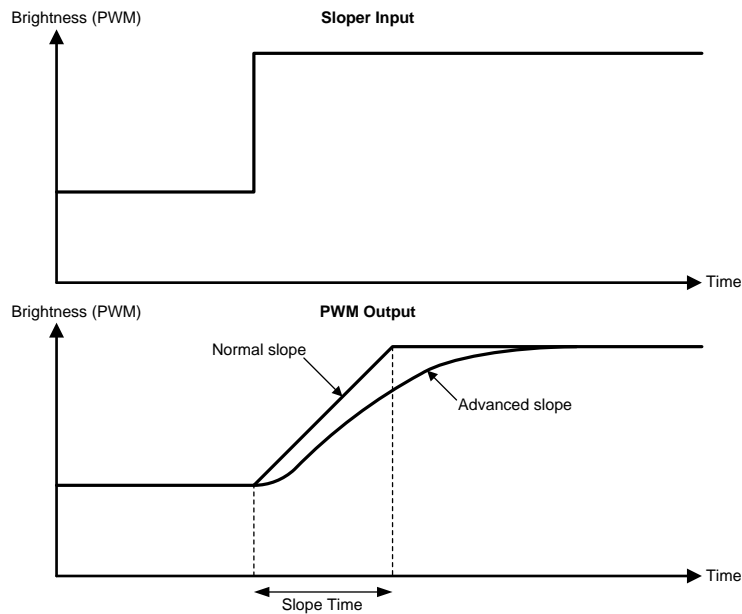

Figure 11. Sloper Operation

### 8.3.2.10 Dithering

Special dithering scheme can be used during brightness changes and in steady state condition. It allows increased resolution and smaller average steps size during brightness changes. Dithering can be programmed with EPROM bits <DITHER[1:0]> from 0 to 3 bits. <STEADY\_DITHER> EPROM bit sets whether the dithering is used also in steady state or only during slopes. Example below is for 1-bit dithering. For 3-bit dithering, every 8th pulse is made 1 LSB longer to increase the average value by 1/8th.

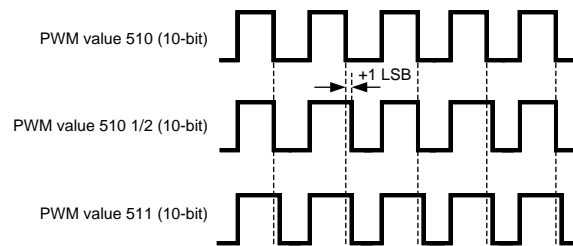

Figure 12. Example of the Dithering, 1-bit Dither, 10-bit Resolution

### 8.3.3 Fault Detection

LP8556 has fault detection for LED open and short conditions, UVLO, overcurrent, and thermal shutdown. The cause for the fault can be read from status register. Reading the fault register also resets the fault.

#### 8.3.3.1 LED Fault Detection

With LED fault detection, the voltages across the LED drivers are constantly monitored. Shorted or open LED strings are detected.

##### 8.3.3.1.1 Open Detect

The logic uses the LOW comparators and the requested boost voltage to detect the OPEN condition. If the logic is asking the boost for the maximum allowed voltage and a LOW comparator is asserted, then the OPEN bit is set in the STATUS register (ADDR = 02h). In normal operation, the adaptive headroom control loop raises the requested boost voltage when the LOW comparator is asserted. If it has raised it as high as it can and an LED string still needs more voltage, then it is assumed to be disconnected from the boost voltage (open or grounded). The actual boost voltage is not part of the OPEN condition decision; only the requested boost voltage and the LOW comparators.

##### 8.3.3.1.2 Short Detect

The logic uses all three comparators (HIGH, MID and LOW) to detect the SHORT condition. When the MID and LOW comparators are de-asserted, the headroom control loop considers that string to be optimized - enough headroom, but not excessive. If at least one LED string is optimized and at least one other LED string has its HIGH comparator asserted, then the SHORT condition is detected. It is important to note that the SHORT condition requires at least two strings for detection: one in the optimized headroom zone (LOW/MID/HIGH comparators all de-asserted) and one in the excessive headroom zone (HIGH comparator asserted).

Fault is cleared by reading the fault register.

#### 8.3.3.2 Undervoltage Detection

The LP8556 device has detection for too-low  $V_{IN}$  voltage. Threshold level for the voltage is set with EPROM register bits as shown in [Table 7](#).

**Table 7. UVLO Truth Table**

UVLO_EN	UVLO_TH	THRESHOLD (V)
0	don't care	OFF
1	0	2.5
1	1	5.2

When undervoltage is detected the LED outputs and the boost shuts down, and the corresponding fault bit is set in the fault register. The LEDs and the boost start again when the voltage has increased above the threshold level. Hysteresis is implemented to threshold level to avoid continuous triggering of fault when threshold is reached.

Fault is cleared by setting the EN / VDDIO pin low or by reading the fault register.

#### 8.3.3.3 Overcurrent Protection

LP8556 has detection for too-high loading on the boost converter. When overcurrent fault is detected, the boost shuts down and the corresponding fault bit is set in the fault register. The boost starts again when the current has dropped below the OCP threshold.

Fault is cleared by reading the fault register.

#### 8.3.3.4 Thermal Shutdown

If the LP8556 reaches thermal shutdown temperature (150°C) the LED outputs and boost shut down to protect it from damage. The device re-activates when temperature drops below 130°C.

Fault is cleared by reading the fault register.

## 8.4 Device Functional Modes

### 8.4.1 Shutdown Mode

The device is in shutdown mode when the EN/VDDIO input is low. Current consumption in this mode from VDD pin is  $< 1.6 \mu\text{A}$ .

### 8.4.2 Active Mode

In active mode the backlight is enabled either with setting the ON register bit high (BRTMODE = 0 1, 10, 11) or by activating PWM input (BRTMODE=00). The powers supplying the VDD and EN/VDDIO pins must be present. Brightness is controlled with I<sup>2</sup>C writes to brightness registers or by changing PWM input duty cycle (operation without I<sup>2</sup>C control). Configuration registers are not accessible in Active mode to prevent damage to the device by accidental writes. Current consumption from VDD pin this mode is typically 2.2 mA when boost is enabled and LEDs are not drawing any current.

## 8.5 Programming

### 8.5.1 I<sup>2</sup>C-Compatible Serial Bus Interface

#### 8.5.1.1 Interface Bus Overview

The I<sup>2</sup>C-compatible synchronous serial interface provides access to the programmable functions and registers on the device. This protocol uses a two-wire interface for bidirectional communications between the ICs connected to the bus. The two interface lines are the Serial Data Line (SDA) and the Serial Clock Line (SCL). These lines must be connected to a positive supply via a pull-up resistor and remain HIGH even when the bus is idle.

Every device on the bus is assigned a unique address and acts as either a Master or a Slave depending on whether it generates or receives the SCL. The LP8556 can operate as an I<sup>2</sup>C slave.

#### 8.5.1.2 Data Transactions

One data bit is transferred during each clock pulse. Data is sampled during the high state of the serial clock SCL. Consequently, throughout the clock's high period, the data should remain stable. Any changes on the SDA line during the high state of the SCL and in the middle of a transaction, aborts the current transaction. New data should be sent during the low SCL state. This protocol permits a single data line to transfer both command/control information and data using the synchronous serial clock.

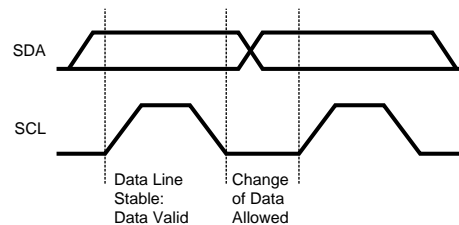

**Figure 13. Bit Transfer**

Each data transaction is composed of a Start Condition, a number of byte transfers (set by the software) and a Stop Condition to terminate the transaction. Every byte written to the SDA bus must be 8 bits long and is transferred with the most significant bit first. After each byte, an Acknowledge signal must follow. The following sections provide further details of this process.

## Programming (continued)

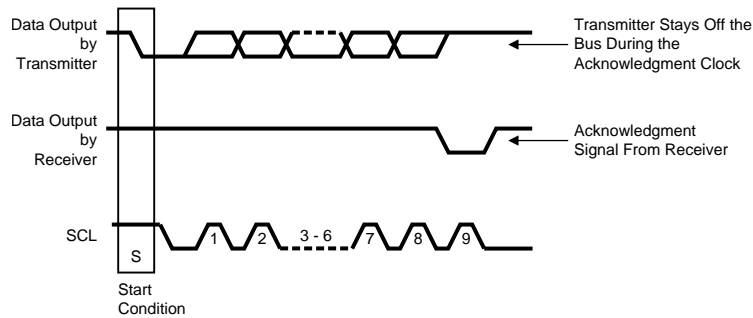

Figure 14. Start and Stop

The Master device on the bus always generates the Start and Stop Conditions (control codes). After a Start Condition is generated, the bus is considered busy and it retains this status until a certain time after a Stop Condition is generated. A high-to-low transition of the data line (SDA) while the clock (SCL) is high indicates a Start Condition. A low-to-high transition of the SDA line while the SCL is high indicates a Stop Condition.

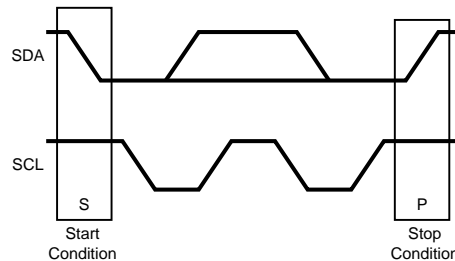

Figure 15. Start and Stop Conditions

In addition to the first Start Condition, a repeated Start Condition can be generated in the middle of a transaction. This allows another device to be accessed, or a register read cycle.

### 8.5.1.3 Acknowledge Cycle

The Acknowledge Cycle consists of two signals: the acknowledge clock pulse the master sends with each byte transferred, and the acknowledge signal sent by the receiving device.

The master generates the acknowledge pulse on the ninth clock pulse of the byte transfer. The transmitter releases the SDA line (permits it to go high) to allow the receiver to send the acknowledge signal. The receiver must pull down the SDA line during the acknowledge clock pulse and ensure that SDA remains low during the high period of the clock pulse, thus signaling the correct reception of the last data byte and its readiness to receive the next byte.

### 8.5.1.4 Acknowledge After Every Byte Rule

The master generates an acknowledge clock pulse after each byte transfer. The receiver sends an acknowledge signal after every byte received.

There is one exception to the *acknowledge after every byte* rule. When the master is the receiver, it must indicate to the transmitter an end of data by not-acknowledging (“negative acknowledge”) the last byte clocked out of the slave. This *negative acknowledge* still includes the acknowledge clock pulse (generated by the master), but the SDA line is not pulled down.

## Programming (continued)

### 8.5.1.5 Addressing Transfer Formats

Each device on the bus has a unique slave address. The LP8556 operates as a slave device with 7-bit address combined with data direction bit. Slave address is 2Ch as 7-bit or 58h for write and 59h for read in 8-bit format.

Before any data is transmitted, the master transmits the slave I.D. The slave device should send an acknowledge signal on the SDA line, once it recognizes its address.

The slave address is the first seven bits after a Start Condition. The direction of the data transfer (R/W) depends on the bit sent after the slave address — the 8th bit.

When the slave address is sent, each device in the system compares this slave address with its own. If there is a match, the device considers itself addressed and sends an acknowledge signal. Depending upon the state of the R/W bit (1:read, 0:write), the device acts as a transmitter or a receiver.

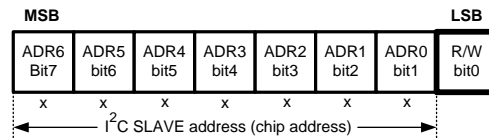

**Figure 16. I<sup>2</sup>C Chip Address (0x2C)**

### 8.5.1.6 Control Register Write Cycle

- Master device generates start condition.
- Master device sends slave address (7 bits) and the data direction bit (r/w = 0).
- Slave device sends acknowledge signal if the slave address is correct.
- Master sends control register address (8 bits).
- Slave sends acknowledge signal.
- Master sends data byte to be written to the addressed register.
- Slave sends acknowledge signal.
- If master sends further data bytes the control register address is incremented by one after acknowledge signal.
- Write cycle ends when the master creates stop condition.

### 8.5.1.7 Control Register Read Cycle

- Master device generates a start condition.
- Master device sends slave address (7 bits) and the data direction bit (r/w = 0).
- Slave device sends acknowledge signal if the slave address is correct.
- Master sends control register address (8 bits).
- Slave sends acknowledge signal.
- Master device generates repeated start condition.
- Master sends the slave address (7 bits) and the data direction bit (r/w = 1).
- Slave sends acknowledge signal if the slave address is correct.
- Slave sends data byte from addressed register.
- If the master device sends acknowledge signal, the control register address is incremented by one. Slave device sends data byte from addressed register.
- Read cycle ends when the master does not generate acknowledge signal after data byte and generates stop condition.

Programming (continued)

Table 8. Data Read and Write Cycles

	ADDRESS MODE
Data Read	<Start Condition> <Slave Address><r/w = 0>[Ack] <Register Addr.>[Ack] <Repeated Start Condition> <Slave Address><r/w = 1>[Ack] [Register Data]<Ack or NAck> ... additional reads from subsequent register address possible <Stop Condition>
Data Write	<Start Condition> <Slave Address><r/w='0'>[Ack] <Register Addr.>[Ack] <Register Data>[Ack] ... additional writes to subsequent register address possible <Stop Condition>

<>Data from master [ ] Data from slave

8.5.1.8 Register Read and Write Detail

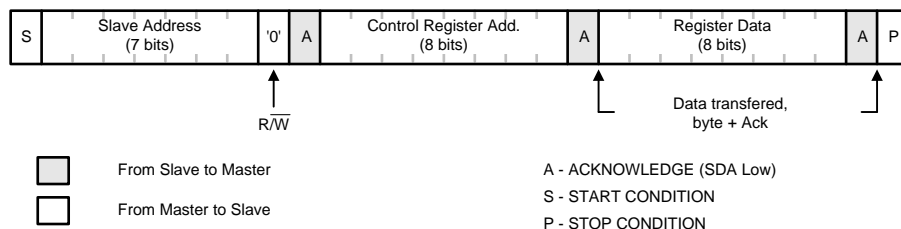

Figure 17. Register Write Format

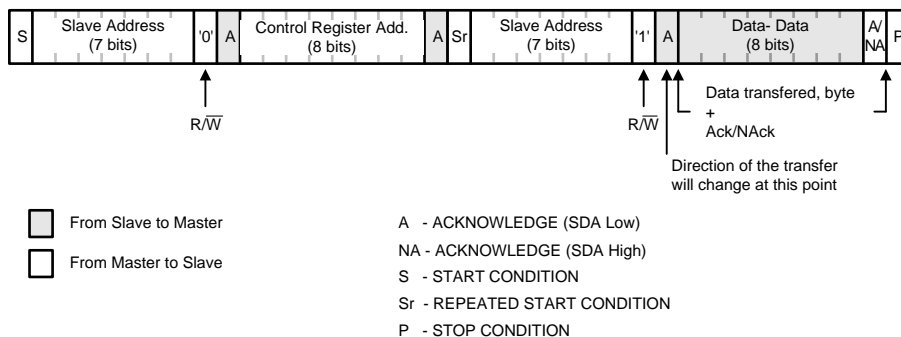

Figure 18. Register Read Format

## 8.6 Register Maps

**Table 9. Register Map**

ADDR	REGISTER	D7	D6	D5	D4	D3	D2	D1	D0	RESET
00H	Brightness Control	BRT[7:0]								0000 0000
01H	Device Control	FAST					BRT_MODE		BL_CTL	0000 0000
02H	Status	OPEN	SHORT	VREF_OK	VBOOST_OK	OVP	OC	TSD	UVLO	0000 0000
04H	Direct Control	LED								0000 0000
16H	LED Enable	LED_EN								0011 1111

**Table 10. EPROM Memory Map**

ADDR	REGISTER	D7	D6	D5	D4	D3	D2	D1	D0
98H	CFG98	IBOOST_LIM_2X	RESERVED			RESERVED			
9EH	CFG9E	RESERVED		VBOOST_RANGE	RESERVED	HEADROOM_OFFSET			
A0H	CFG0	CURRENT_LSB							
A1H	CFG1	PDET_STDBY	CURRENT_MAX			CURRENT_MSB			
A2H	CFG2	RESERVED		UVLO_EN	UVLO_TH	BL_ON	ISET_EN	BOOST_FSET_EN	PWM_FSET_EN
A3H	CFG3	RESERVED	SLOPE			FILTER		PWM_INPUT_HYSTERESIS	
A4H	CFG4	PWM_TO_I_THRESHOLD				RESERVED	STEADY_DITHER	DITHER	
A5H	CFG5	PWM_DIRECT	PS_MODE			PWM_FREQ			
A6H	CFG6	BOOST_FREQ		VBOOST					
A7H	CFG7	RESERVED		EN_DRV3	EN_DRV2	RESERVED		IBOOST_LIM	
A8H	CFG8	RESERVED		RESERVED		RESERVED		RESERVED	
A9H	CFG9	VBOOST_MAX			JUMP_EN	JUMP_THRESHOLD		JUMP_VOLTAGE	
AAH	CFG9A	SSCLK_EN	RESERVED	RESERVED		ADAPTIVE	DRIVER_HEADROOM		
ABH	CFG9B	RESERVED							
ACH	CFG9C	RESERVED				RESERVED			
ADH	CFG9D	RESERVED							
AEH	CFG9E	STEP_UP		STEP_DN		LED_FAULT_TH		LED_COMP_HYST	
AFH	CFG9F	REVISION							



## 8.6.1 Register Bit Explanations

### 8.6.1.1 Brightness Control

Address 00h

Reset value 0000 0000b

BRIGHTNESS CONTROL REGISTER							
7	6	5	4	3	2	1	0
BRT[7:0]							
NAME	BIT	ACCESS	DESCRIPTION				
BRT	7:0	R/W	Backlight PWM 8-bit linear control.				

### 8.6.1.2 Device Control

Address 01h

Reset value 0000 0000b

DEVICE CONTROL REGISTER							
7	6	5	4	3	2	1	0
FAST					BRT_MODE[1:0]		BL_CTL
NAME	BIT	ACCESS	DESCRIPTION				
FAST	7		Skip refresh of trim and configuration registers from EPROMs when exiting the low power STANDBY mode. 0 = read EPROMs before returning to the ACTIVE state 1 = only read EPROMs once on initial power-up.				
BRT_MODE	2:1	R/W	Brightness source mode <a href="#">Figure 7</a> 00b = PWM input only 01b = PWM input and Brightness register (combined before shaper block) 10b = Brightness register only 11b = PWM input and Brightness register (combined after shaper block)				
BL_CTL	0	R/W	Enable backlight when Brightness Register is used to control brightness (BRT_MODE = 10). 0 = Backlight disabled and chip turned off 1 = Backlight enabled and chip turned on  This bit has no effect when PWM pin control is selected for brightness control (BRT_MODE = 00). In this mode the state of PWM pin enable or disables the chip.				

### 8.6.1.3 Status

Address 02h

Reset value 0000 0000b

FAULT REGISTER							
7	6	5	4	3	2	1	0
OPEN	SHORT	VREF_OK	VBOOST_OK	OVP	OCP	TSD	UVLO
NAME	BIT	ACCESS	DESCRIPTION				
OPEN	7	R	LED open fault detection				
			0 = No fault				
			1 = LED open fault detected. The value is not latched.				
SHORT	6	R	LED short fault detection				
			0 = No fault				
			1 = LED short fault detected. The value is not latched.				
VREF_OK	5	R	Internal VREF node monitor status				
			1 = VREF voltage is OK.				
VBOOST_OK	4	R	Boost output voltage monitor status				
			0 = Boost output voltage has not reached its target ( $V_{BOOST} < V_{target} - 2.5V$ )				
			1 = Boost output voltage is OK. The value is not latched.				
OVP	3	R	Overvoltage protection				
			0 = No fault				
			1 = Overvoltage condition occurred. Fault is cleared by reading the register 02h.				
OCP	2	R	Over current protection				
			0 = No fault				
			1 = Overcurrent condition occurred. Fault bit is cleared by reading this register.				
TSD	1	R	Thermal shutdown				
			0 = No fault				
			1 = Thermal fault generated, 150°C reached. Boost converter and LED outputs are disabled until the temperature has dropped down to 130°C. Fault is cleared by reading this register.				
UVLO	0	R	Undervoltage detection				
			0 = No fault				
			1 = Undervoltage detected on the $V_{DD}$ pin. Boost converter and LED outputs are disabled until $V_{DD}$ voltage is above the UVLO threshold voltage. Threshold voltage is set with EPROM bits. Fault is cleared by reading this register.				

### 8.6.1.4 Direct Control

Address 04h

Reset value 0000 0000b

DIRECT CONTROL REGISTER							
7	6	5	4	3	2	1	0
					OUT[5:0]		
NAME	BIT	ACCESS	DESCRIPTION				
OUT	5:0	R/W	Direct control of the LED outputs				
			0 = Normal operation. LED output are controlled with the adaptive dimming block				
			1 = LED output is forced to 100% PWM.				

### 8.6.1.5 LED String Enable

Address 16h

Reset value 0011 1111b

TEMP LSB REGISTER							
7	6	5	4	3	2	1	0
LED_EN[5:0]							
NAME	BIT	ACCESS	DESCRIPTION				
LED_EN	5:0	R/W	Bits 5:0 correspond to LED Strings 6:1 respectively. Bit value 1 = LED String Enabled Bit value 0 = LED String Disabled Note: To disable string(s), it is recommended to disable higher order string(s). For example, for 5-string configuration, disable 6th String. For 4-string configuration, disable 6th and 5th string. These bits are ANDed with the internal LED enable bits that are generated with the PS_MODE logic.				

## 8.6.2 EPROM Bit Explanations

### 8.6.2.1 LP8556<sup>TM</sup> (DSBGA) Configurations and Pre-Configured EPROM Settings

ADDRESS	LP8556-E02	LP8556-E03	LP8556-E04	LP8556-E05 <sup>(1)</sup>
98h[7]	0b	0b	0b	0b
9Eh	22h	24h	24h	22h
A0h	FFh	FFh	FFh	
A1h	5Fh	BFh	3Fh	
A2h	20h	28h	2Fh	
A3h	5Eh	5Eh	5Eh	
A4h	72h	72h	72h	
A5h	04h	14h	04h	
A6h	80h	80h	80h	
A7h	F7h	F7h	F7h	
A9h	80h	A0h	60h	
AAh	0Fh	0Fh	0Fh	
ABh	00h	00h	00h	
ACH	00h	00h	00h	
ADh	00h	00h	00h	
A Eh	0Fh	0Fh	0Fh	
AFh	05h	03h	03h	

(1) LP8556-E05 is a device option with un-configured EPROM settings. This option is for users that desire programming the device by themselves. Bits 98h[7] and 9Eh[5] are always pre-configured.

### 8.6.2.2 LP8556<sup>TM</sup> (DSBGA) Configurations and Pre-configured EPROM Settings Continued

ADDRESS	LP8556-E06	LP8556-E07	LP8556-E09	LP8556-E11
98h[7]	0b	0b	0b	0b
9Eh	22h	04h	22h	02h
A0h	FFh	FFh	FFh	FFh
A1h	DBh	BFh	CFh	4Fh
A2h	2Fh	0Dh	2Fh	20h
A3h	02h	02h	02h	03h
A4h	72h	72h	72h	12h
A5h	14h	20h	04h	3Ch
A6h	40h	4Eh	80h	40h
A7h	F7h	F6h	F7h	F4h
A9h	DBh	C0h	A0h	80h
AAh	0Fh	0Fh	0Fh	0Fh
ABh	00h	00h	00h	00h
ACH	00h	00h	00h	00h
ADh	00h	00h	00h	00h
A Eh	0Fh	0Fh	0Eh	0Fh
AFh	05h	03h	05h	01h

### 8.6.2.3 LP8556SQ (WQFN) Configurations and Pre-configured EPROM Settings

ADDRESS	LP8556-E00	LP8556-E08	LP8556-E09
98h[7]	1b	1b	1b
9Eh	22h	22h	22h
A0h	FFh	FFh	FFh
A1h	CFh	CFh	CFh
A2h	2Fh	2Fh	2Fh
A3h	5Eh	5Eh	02h
A4h	72h	72h	72h
A5h	14h	24h	04h
A6h	80h	80h	80h
A7h	F6h	F6h	F6h
A9h	A0h	A0h	A0h
AAh	0Fh	0Fh	0Fh
ABh	00h	00h	00h
ACh	00h	00h	00h
ADh	00h	00h	00h
A Eh	0Fh	0Fh	0Fh
AFh	01h	01h	01h

### 8.6.2.4 CFG98

Address 98h

CFG98 REGISTER							
7	6	5	4	3	2	1	0
IBOOST_LIM_2X							
NAME	BIT	ACCESS	DESCRIPTION				
IBOOST_LIM_2X	7	R/W	Select the inductor current limit range. When IBOOST_LIM_2X = 0, the inductor current limit can be set to 0.9 A, 1.2 A, 1.5 A or 1.8 A. When IBOOST_LIM_2X = 1, the inductor current limit can be set to 1.6 A, 2.1 A, or 2.6 A . This option is supported only on WQFN package and not on DSBGA package. See <sup>(1)</sup> .				

- (1) 1.8 A is the maximum  $I_{SW\_LIM}$  supported with the DSBGA package. For applications requiring the  $I_{SW\_LIM}$  to be greater than 1.8 A and up to 2.6 A, WQFN package should be considered.

**8.6.2.5 CFG9E**

Address 9Eh

CFG9E REGISTER							
7	6	5	4	3	2	1	0
VBOOST_RANGE			HEADROOM_OFFSET				
NAME	BIT	ACCESS	DESCRIPTION				
VBOOST_RANGE	5	R/W	Select VBOOST range. When VBOOST_RANGE = 0, the output voltage range is from 7 V to 34 V When VBOOST_RANGE = 1, the output voltage range is from 16 V to 43 V In applications with an output voltage higher than 16 V, VBOOST_RANGE = 1 is preferred.				
HEADROOM_OFFSET	3:0	R/W	LED driver headroom offset. This adjusts the LOW comparator threshold together with LED_HEADROOM bits and contributes to the MID comparator threshold. 0000 = 460 mV 0001 = 390 mV 0010 = 320 mV 0100 = 250 mV 1000 = 180 mV				

**8.6.2.6 CFG0**

Address A0h

CFG0 REGISTER							
7	6	5	4	3	2	1	0
CURRENT_LSB[7:0]							
NAME	BIT	ACCESS	DESCRIPTION				
CURRENT_LSB	7:0	R/W	The 8-bits in this register (LSB) along the 4-bits defined in <a href="#">CFG1</a> Register (MSB) allow LED current to be set in 12-bit fine steps. These 12-bits further scale the maximum LED current set using <a href="#">CFG1</a> Register, CURRENT_MAX bits (denoted as I <sub>MAX</sub> ). If ISET_EN = 0, the LED current is defined with the bits as shown below. If ISET_EN = 1, then the external resistor connected to the ISET pin scales the LED current as shown below.				
					ISET_EN = 0	ISET_EN = 1	
			0000 0000 0000		0A	0A	
			0000 0000 0001		$(1/4095) \times I_{MAX}$	$(1/4095) \times I_{MAX} \times 20,000 \times 1.2V / R_{ISET}$	
			0000 0000 0010		$(2/4095) \times I_{MAX}$	$(2/4095) \times I_{MAX} \times 20,000 \times 1.2V / R_{ISET}$	
			...		...	...	
			0111 1111 1111		$(2047/4095) \times I_{MAX}$	$(2047/4095) \times I_{MAX} \times 20,000 \times 1.2V / R_{ISET}$	
			...		...	...	
			1111 1111 1101		$(4093/4095) \times I_{MAX}$	$(4093/4095) \times I_{MAX} \times 20,000 \times 1.2V / R_{ISET}$	
			1111 1111 1110		$(4094/4095) \times I_{MAX}$	$(4094/4095) \times I_{MAX} \times 20,000 \times 1.2V / R_{ISET}$	
1111 1111 1111		$(4095/4095) \times I_{MAX}$	$(4095/4095) \times I_{MAX} \times 20,000 \times 1.2V / R_{ISET}$				

### 8.6.2.7 CFG1

Address A1h

CFG1 REGISTER							
7	6	5	4	3	2	1	0
PDET_STDBY	CURRENT_MAX[2:0]			CURRENT_MSB[11:8]			
NAME	BIT	ACCESS	DESCRIPTION				
PDET_STDBY	7	R/W	Enable Standby when PWM input is constant low (approx. 50 ms timeout).				
CURRENT_MAX	6:4	R/W	Set Maximum LED current as shown below. This maximum current is scaled as described in the <a href="#">CFG0</a> Register. 000 = 5 mA 001 = 10 mA 010 = 15 mA 011 = 20 mA 100 = 23 mA 101 = 25 mA 110 = 30 mA 111 = 50 mA				
CURRENT_MSB	3:0	R/W	These bits form the 4 MSB bits for LED Current as described in <a href="#">CFG0</a> Register.				

### 8.6.2.8 CFG2

Address A2h

CFG2 REGISTER							
7	6	5	4	3	2	1	0
RESERVED		UVLO_EN	UVLO_TH	BL_ON	ISET_EN	BOOST_FSET_EN	PWM_FSET_EN
NAME	BIT	ACCESS	DESCRIPTION				
RESERVED	7:6	R/W					
UVLO_EN	5	R/W	Undervoltage lockout protection enable.				
UVLO_TH	4	R/W	UVLO threshold levels: 0 = 2.5 V 1 = 5.2 V				
BL_ON	3	R/W	Enable backlight. This bit must be set for PWM only control. 0 = Backlight disabled. This selection is recommended for systems with an I <sup>2</sup> C master. With an I <sup>2</sup> C master, the backlight can be controlled by writing to the register 01h. 1 = Backlight enabled. This selection is recommended for systems with PWM only control.				
ISET_EN	2	R/W	Enable LED current set resistor. 0 = Resistor is disabled and current is set with CURRENT and CURRENT_MAX EPROM register bits. 1 = Resistor is enabled and current is set with the R <sub>ISET</sub> resistor AND CURRENT AND CURRENT_MAX EPROM register bits.				
BOOST_FSET_EN	1	R/W	Enable configuration of the switching frequency via FSET pin. 0 = Configuration of the switching frequency via FSET pin is disabled. The switching frequency is set with BOOST_FREQ EPROM register bits. 1 = Configuration of the switching frequency via FSET pin is enabled.				
PWM_FSET_EN	0	R/W	Enable configuration of the PWM dimming frequency via FSET pin. 0 = Configuration of the switching frequency via FSET pin is disabled. The switching frequency is set with PWM_FREQ EPROM register bits. 1 = Configuration of the PWM dimming frequency via FSET pin is enabled.				

### 8.6.2.9 CFG3

Address A3h

CFG3 REGISTER							
7	6	5	4	3	2	1	0
RESERVED	SLOPE[2:0]			FILTER[1:0]		PWM_INPUT_HYSTERESIS[1:0]	
NAME	BIT	ACCESS	DESCRIPTION				
RESERVED	7	R/W					
SLOPE	6:4	R/W	Select brightness change transition duration 000 = 0 ms (immediate change) 001 = 1 ms 010 = 2 ms 011 = 50 ms 100 = 100 ms 101 = 200 ms 110 = 300 ms 111 = 500 ms				
FILTER	3:2	R/W	Select brightness change transition filtering strength 00 = No filtering 01 = light smoothing 10 = medium smoothing 11 = heavy smoothing				
PWM_INPUT_HYSTERESIS	1:0	R/W	PWM input hysteresis function. 00 = OFF 01 = 1-bit hysteresis with 13-bit resolution 10 = 1-bit hysteresis with 12-bit resolution 11 = 1-bit hysteresis with 8-bit resolution				

### 8.6.2.10 CFG4

Address A4h

CFG4 REGISTER							
7	6	5	4	3	2	1	0
PWM_TO_I_THRESHOLD[3:0]				RESERVED	STEADY_DITHER	DITHER[1:0]	
NAME	BIT	ACCESS	DESCRIPTION				
PWM_TO_I_THRESHOLD	7:4	R/W	Select switch point between PWM and pure current dimming 0000 = current dimming across entire range 0001 = switch point at <b>10%</b> of the maximum LED current. 0010 = switch point at <b>12.5%</b> of the maximum LED current. 0011 = switch point at <b>15%</b> of the maximum LED current. 0100 = switch point at <b>17.5%</b> of the maximum LED current. 0101 = switch point at <b>20%</b> of the maximum LED current. 0110 = switch point at <b>22.5%</b> of the maximum LED current. 0111 = switch point at <b>25%</b> of the maximum LED current. This is a recommended selection. 1000 = switch point at <b>33.33%</b> of the maximum LED current. 1001 = switch point at <b>41.67%</b> of the maximum LED current. 1010 = switch point at <b>50%</b> of the maximum LED current. 1011 to 1111 = PWM dimming across entire range				
RESERVED	3	R/W					
STEADY_DITHER	2	R/W	Dither function method select: 0 = Dither only on transitions 1 = Dither at all times				
DITHER	1:0	R/W	Dither function control 00 = Dithering disabled 01 = 1-bit dithering 10 = 2-bit dithering 11 = 3-bit dithering				



**8.6.2.11 CFG5**

Address A5h

CFG5 REGISTER							
7	6	5	4	3	2	1	0
PWM_DIRECT		PS_MODE[2:0]			PWM_FREQ[3:0]		
NAME	BIT	ACCESS	DESCRIPTION				
PWM_DIRECT	7	R/W	Intended for certain test mode purposes. When enabled, the entire pipeline is bypassed and PWM output is connected with PWM input.				
PS_MODE	6:4	R/W	Select PWM output phase configuration: 000 = 6-phase, 6 drivers (0°, 60°, 120°, 180°, 240°, 320°) 001 = 5-phase, 5 drivers (0°, 72°, 144°, 216°, 288°, OFF) 010 = 4-phase, 4 drivers (0°, 90°, 180°, 270°, OFF, OFF) 011 = 3-phase, 3 drivers (0°, 120°, 240°, OFF, OFF, OFF) 100 = 2-phase, 2 drivers (0°, 180°, OFF, OFF, OFF, OFF) 101 = 3-phase, 6 drivers (0°, 0°, 120°, 120°, 240°, 240°) 110 = 2-phase, 6 drivers (0°, 0°, 0°, 180°, 180°, 180°) 111 = 1-phase, 6 drivers (0°, 0°, 0°, 0°, 0°, 0°)				
PWM_FREQ	3:0	R/W	0h = 4,808 Hz (11-bit) 1h = 6,010 Hz (10-bit) 2h = 7,212 Hz (10-bit) 3h = 8,414 Hz (10-bit) 4h = 9,616 Hz (10-bit) 5h = 12,020 Hz (9-bit) 6h = 13,222 Hz (9-bit) 7h = 14,424 Hz (9-bit) 8h = 15,626 Hz (9-bit) 9h = 16,828 Hz (9-bit) Ah = 18,030 Hz (9-bit) Bh = 19,232 Hz (9-bit) Ch = 24,040 Hz (8-bit) Dh = 28,848 Hz (8-bit) Eh = 33,656 Hz (8-bit) Fh = 38,464 Hz(8-bit)				

**8.6.2.12 CFG6**

Address A6h

CFG6 REGISTER							
7	6	5	4	3	2	1	0
BOOST_FREQ[1:0]		VBOOST[5:0]					
NAME	BIT	ACCESS	DESCRIPTION				
BOOST_FREQ	7:6	R/W	Set boost switching frequency when BOOST_FSET_EN = 0. 00 = 312 kHz 01 = 625 kHz 10 = 1250 kHz 11 = undefined				
VBOOST	5:0	R/W	Boost output voltage. When ADAPTIVE = 1, this is the boost minimum and initial voltage.				

**8.6.2.13 CFG7**

Address A7h

CFG7 REGISTER							
7	6	5	4	3	2	1	0
RESERVED		EN_DRV3	EN_DRV2	RESERVED		IBOOST_LIM[1:0]	
NAME	BIT	ACCESS	DESCRIPTION				
RESERVED	7:6						
EN_DRV3	5	R/W	Selects boost driver strength to set boost slew rate. See <a href="#">EMI Reduction</a> for more detail. 0 = Driver3 disabled 1 = Driver3 enabled				
EN_DRV2	4	R/W	Selects boost driver strength to set boost slew rate. See <a href="#">EMI Reduction</a> for more detail. 0 = Driver2 disabled 1 = Driver2 enabled				
RESERVED	3:2	R/W					
IBOOST_LIM	1:0	R/W	Select boost inductor current limit (IBOOST_LIM_2X = 0 / IBOOST_LIM_2X = 1) 00 = 0.9 A / 1.6 A 01 = 1.2 A / 2.1 A 10 = 1.5 A / 2.6 A 11 = 1.8 A / not permitted				

**8.6.2.14 CFG9**

Address A9h

CFG9 REGISTER							
7	6	5	4	3	2	1	0
VBOOST_MAX[2:0]			JUMP_EN	JUMP_THRESHOLD[1:0]		JUMP_VOLTAGE[1:0]	
NAME	BIT	ACCESS	DESCRIPTION				
VBOOST_MAX	7:5	R/W	Select the maximum boost voltage (typ values) ( VBOOST_RANGE = 0 / VBOOST_RANGE = 1) 010 = NA / 21 V 011 = NA / 25 V 100 = 21 V / 30 V 101 = 25 V / 34.5 V 110 = 30 V / 39 V 111 = 34 V / 43 V				
JUMP_EN	4	R/W	Enable JUMP detection on the PWM input.				
JUMP_THRESHOLD	3:2	R/W	Select JUMP threshold: 00 = 10% 01 = 30% 10 = 50% 11 = 70%				
JUMP_VOLTAGE	1:0	R/W	Select JUMP voltage: 00 = 0.5 V 01 = 1 V 10 = 2 V 11 = 4 V				

**8.6.2.15 CFGA**

Address AAh

CFG9 REGISTER							
7	6	5	4	3	2	1	0
SSCLK_EN	RESERVED	RESERVED		ADAPTIVE	DRIVER_HEADROOM[2:0]		
NAME	BIT	ACCESS	DESCRIPTION				
SSCLK_EN	7	R/W	Enable spread spectrum function				
RESERVED	6	R/W					
RESERVED	5:4	R/W					
ADAPTIVE	3	R/W	Enable adaptive boost control				
DRIVER_HEADROOM	2:0	R/W	LED driver headroom control. This sets the LOW comparator threshold and contributes to the MID comparator threshold. 000 = HEADROOM_OFFSET + 875 mV 001 = HEADROOM_OFFSET + 750 mV 010 = HEADROOM_OFFSET + 625 mV 011 = HEADROOM_OFFSET + 500 mV 100 = HEADROOM_OFFSET + 375 mV 101 = HEADROOM_OFFSET + 250 mV 110 = HEADROOM_OFFSET + 125 mV 111 = HEADROOM_OFFSET mV				

**8.6.2.16 CFGE**

Address AEh

CFGF REGISTER							
7	6	5	4	3	2	1	0
STEP_UP[1:0]		STEP_DN[1:0]		LED_FAULT_TH[2:0]		LED_COMP_HYST[1:0]	
NAME	BIT	ACCESS	DESCRIPTION				
STEP_UP	7:6	R/W	Adaptive headroom UP step size 00 = 105 mV 01 = 210 mV 10 = 420 mV 11 = 840 mV				
STEP_DN	5:4	R/W	Adaptive headroom DOWN step size 00 = 105 mV 01 = 210 mV 10 = 420 mV 11 = 840 mV				
LED_FAULT_TH	3:2	R/W	LED headroom fault threshold. This sets the HIGH comparator threshold. 00 = 5 V 01 = 4 V 10 = 3 V 11 = 2 V				
LED_COMP_HYST	1:0	R/W	LED headrom comparison hysteresis. This sets the MID comparator threshold. 00 = DRIVER_HEADROOM + 1000 mV 01 = DRIVER_HEADROOM + 750 mV 10 = DRIVER_HEADROOM + 500 mV 11 = DRIVER_HEADROOM + 250 mV				

**8.6.2.17 CFGF**

Address AFh

CFGF REGISTER							
7	6	5	4	3	2	1	0
REVISION							
NAME	BIT	ACCESS	DESCRIPTION				
REV	7:0	R/W	EPROM Settings Revision ID code				

## 9 Application and Implementation

### NOTE

Information in the following applications sections is not part of the TI component specification, and TI does not warrant its accuracy or completeness. TI's customers are responsible for determining suitability of components for their purposes. Customers should validate and test their design implementation to confirm system functionality.

### 9.1 Application Information

#### 9.1.1 Using LP8556 With I<sup>2</sup>C Host

##### 9.1.1.1 Setting Boost Switching and PWM Dimming Frequencies

Boost switching and PWM dimming frequencies can be set via EEPROM when BOOST\_FSET\_EN = 0 and PWM\_FSET\_EN = 0. Available options are shown in [Table 11](#) and [Table 12](#).

**Table 11. Configuring Boost Switching Frequency via EPROM**

BOOST_FSET_EN	BOOST_FREQ[1:0]	$f_{sw}$ [kHz]
0	00	312
0	01	625
0	10	1250
0	11	Reserved

**Table 12. Configuring PWM Dimming Frequency via EPROM**

PWM_FSET_EN	PWM_FREQ[3:0]	$f_{PWM}$ [Hz] (Resolution)
0	0000	4808 (11-bit)
0	0001	6010 (10-bit)
0	0010	7212 (10-bit)
0	0011	8414 (10-bit)
0	0100	9616 (10-bit)
0	0101	12020 (9-bit)
0	0110	13222 (9-bit)
0	0111	14424 (9-bit)
0	1000	15626 (9-bit)
0	1001	16828 (9-bit)
0	1010	18030 (9-bit)
0	1011	19232 (9-bit)
0	1100	24040 (8-bit)
0	1101	28848 (8-bit)
0	1110	33656 (8-bit)
0	1111	38464 (8-bit)

##### 9.1.1.2 Setting Full-Scale LED Current

The LED current per output is configured by programming the CURRENT\_MAX and CURRENT registers when ISET\_EN = 0. Available options are shown below.

**Table 13. Setting Full-Scale LED Current with EEPROM**

ISET_EN	CURRENT_MAX	CURRENT[11:0]	FULL-SCALE ILED [mA]
0	0	FFFh	5
0	1	FFFh	10
0	10	FFFh	15
0	11	FFFh	20
0	100	FFFh	23
0	101	FFFh	25
0	110	FFFh	30
0	111	FFFh	50
0	000 – 111	001h – FFFh	(CURRENT/4095) × CURRENT_IMAX

**9.1.2 Using LP8556 With Configuration Resistors and IO Pins**

**9.1.2.1 Setting Boost Switching and PWM Dimming Frequencies**

Boost switching and PWM dimming frequencies can be set via resistor when BOOST\_FSET\_EN = 1 and PWM\_FSET\_EN = 1. Available options are shown in [Table 14](#).

**Table 14. Configuring PWM Dimming Frequency With an External Resistor**

RFSET [kΩ] (TOLERANCE)	f <sub>sw</sub> [kHz] BOOST_FSET_EN = 1	f <sub>PWM</sub> [Hz] (RESOLUTION) PWM_FSET_EN = 1
Floating or FSET pin pulled HIGH	1250	9616 (10-bit)
470 k - 1 M (±5%)	312	2402 (12-bit)
300 k, 330 k (±5%)	312	4808 (11-bit)
200 k (±5%)	312	6010 (10-bit)
147 k, 150k, 154 k, 158k (±1%)	312	9616 (10-bit)
121 k (±1%)	312	12020 (9-bit)
100 k (±1%)	312	14424 (9-bit)
86.6 k (±1%)	312	16828 (9-bit)
75 k (±1%)	312	19232 (9-bit)
63.4 k (±1%)	625	2402 (12-bit)
52.3 k, 53.6 k (±1%)	625	4808 (11-bit)
44.2k, 45.3 k (±1%)	625	6010 (10-bit)
39.2 k (±1%)	625	9616 (10-bit)
34 k (±1%)	625	12020 (9-bit)
30.1k (±1%)	625	14424 (9-bit)
26.1 k (±1%)	625	16828 (9-bit)
23.2 k (±1%)	625	19232 (9-bit)
20.5 k (±1%)	1250	2402 (12-bit)
18.7 k (±1%)	1250	4808 (11-bit)
16.5k (±1%)	1250	6010 (10-bit)
14.7 k (±1%)	1250	9616 (10-bit)
13 k (±1%)	1250	12020 (9-bit)
11.8k (±1%)	1250	14424 (9-bit)
10.7 k (±1%)	1250	16828 (9-bit)
9.76 k (±1%)	1250	19232 (9-bit)
FSET pin shorted to GND	1250	Same as PWM input frequency

### 9.1.2.2 Setting Full-Scale LED Current

The LED current per output is configured by ISET resistor when ISET\_EN=1. In this mode the CURRENT\_IMAX and CURRENT registers can also further scale the LED current. Available options are shown in Table 15.

Table 15. Setting Full-Scale LED Current with ISET Resistor

RISET [Ω]	ISET_EN	CURRENT_MAX	CURRENT[11:0]	FULL-SCALE ILED [mA]
24 k	1	0	FFFh	5
24 k	1	1	FFFh	10
24 k	1	10	FFFh	15
24 k	1	11	FFFh	20
24 k	1	100	FFFh	23
24 k	1	101	FFFh	25
24 k	1	110	FFFh	30
24 k	1	111	FFFh	50
12 k – 100 k	1	000–111	001h–FFFh	$(CURRENT/4095) \times IMAX \times 20,000 \times 1.2 V / R_{ISET}$

## 9.2 Typical Application

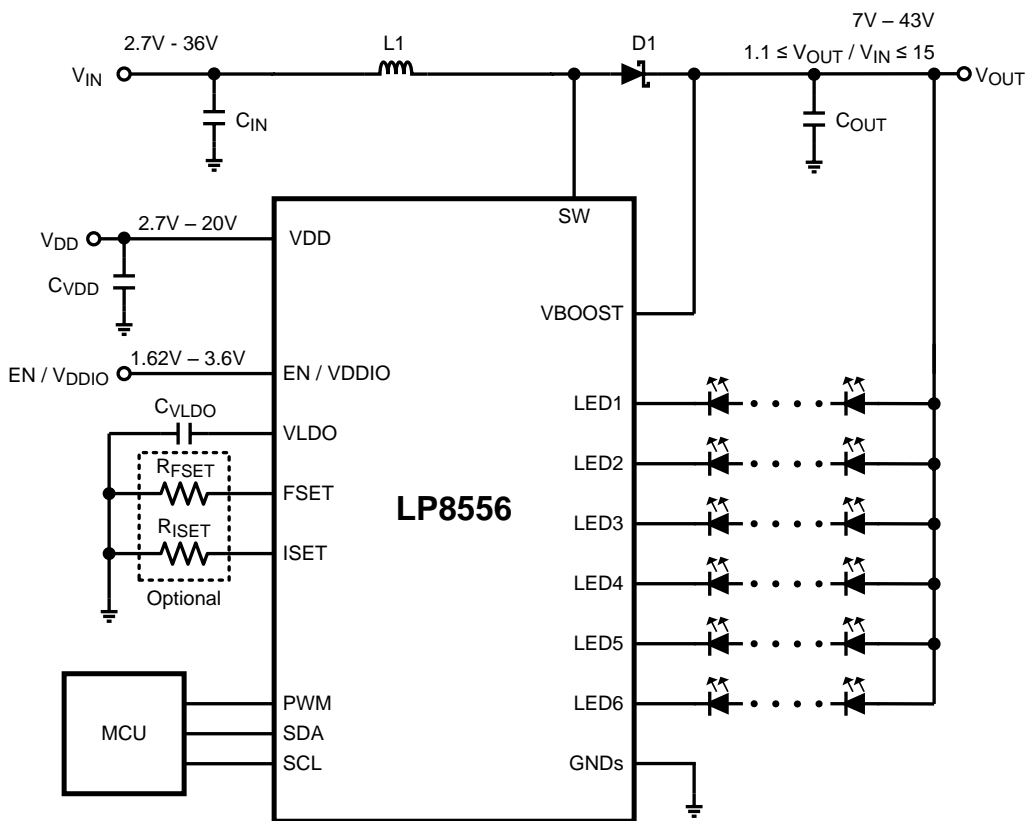

Figure 19. LP8556 Typical Application Schematic

## Typical Application (continued)

### 9.2.1 Design Requirements

**Table 16. Recommended Inductance**

$f_{sw}$	MIN	TYP	MAX	UNIT
1250	3.3		22	$\mu\text{H}$
625	6.8		68	$\mu\text{H}$
312	10		100	$\mu\text{H}$

**Table 17. Recommended Output Capacitance**

$f_{sw}$	MIN	TYP	MAX	UNIT
1250	4.7			$\mu\text{F}$
625	4.7			$\mu\text{F}$
312	10			$\mu\text{F}$

### 9.2.2 Detailed Design Procedure

#### 9.2.2.1 Recommended Inductance for the Boost Power Stage

Assumes 20 mA as the maximum LED current per string and 3.3 V as the maximum LED forward voltage.

NUMBER OF LED STRINGS	NUMBER OF LEDS PER STRING	BOOST INPUT VOLTAGE RANGE	L1 INDUCTANCE		
			$f_{sw} = 1250 \text{ kHz}$	$f_{sw} = 625 \text{ kHz}$	$f_{sw} = 312 \text{ kHz}$
6	6	2.7 V - 4.4 V	3.3 $\mu\text{H}$ - 6.8 $\mu\text{H}$	6.8 $\mu\text{H}$ - 15 $\mu\text{H}$	10 $\mu\text{H}$ - 33 $\mu\text{H}$
		5.4 V - 8.8 V	10 $\mu\text{H}$ - 22 $\mu\text{H}$	22 $\mu\text{H}$ - 47 $\mu\text{H}$	47 $\mu\text{H}$ - 100 $\mu\text{H}$
6	8	2.7 V - 4.4 V	4.7 $\mu\text{H}$ - 10 $\mu\text{H}$	10 $\mu\text{H}$ - 15 $\mu\text{H}$	22 $\mu\text{H}$ - 33 $\mu\text{H}$
		5.4 V - 8.8 V	10 $\mu\text{H}$ - 22 $\mu\text{H}$	22 $\mu\text{H}$ - 68 $\mu\text{H}$	47 $\mu\text{H}$ - 100 $\mu\text{H}$
4	10	5.4 V - 8.8 V	6.8 $\mu\text{H}$ - 22 $\mu\text{H}$	22 $\mu\text{H}$ - 47 $\mu\text{H}$	47 $\mu\text{H}$ - 100 $\mu\text{H}$
4	12	5.4 V - 8.8 V	10 $\mu\text{H}$ - 22 $\mu\text{H}$	22 $\mu\text{H}$ - 47 $\mu\text{H}$	33 $\mu\text{H}$ - 100 $\mu\text{H}$

#### 9.2.2.2 Recommended Capacitances for the Boost and LDO Power Stages<sup>(1)</sup>

SWITCHING FREQUENCY [kHz]	$C_{IN}$ [ $\mu\text{F}$ ]	$C_{OUT}$ [ $\mu\text{F}$ ]	$C_{VLDO}$ [ $\mu\text{F}$ ]
1250	2.2	4.7	10
625	2.2	4.7	10
312	4.7	10	10

(1) Capacitance of Multi-Layer Ceramic Capacitors (MLCC) can change significantly with the applied DC voltage. Use capacitors with good capacitance versus DC bias characteristics. In general, MLCC in bigger packages have lower capacitance de-rating than physically smaller capacitors.



### 9.2.3 Application Curves

Unless otherwise specified:  $V_{IN} = 3.8\text{ V}$ ,  $C_{VLD0} = 10\ \mu\text{F}$ ,  $L_1 = 4.7\ \mu\text{H}$ ,  $C_{IN} = 2.2\ \mu\text{F}$ ,  $C_{OUT} = 4.7\ \mu\text{F}$ ,  $f_{SW} = 1.25\ \text{MHz}$

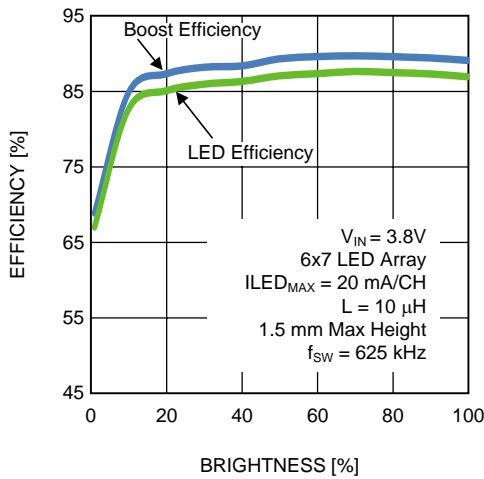

Figure 20. Boost and LED Drive Efficiency

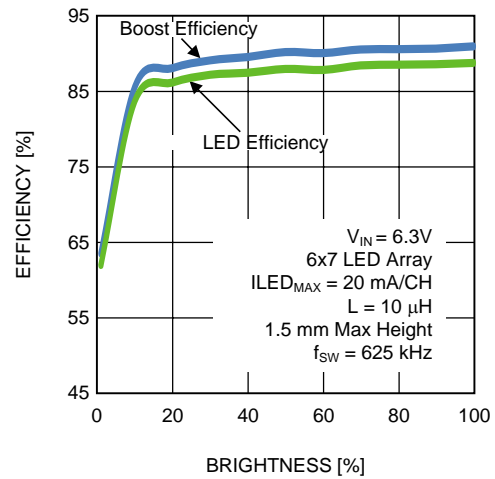

Figure 21. Boost and LED Drive Efficiency

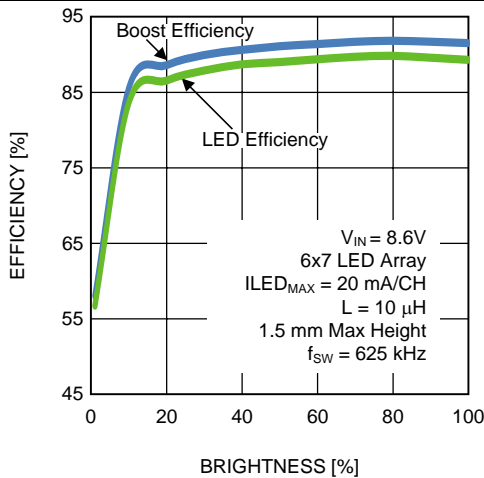

Figure 22. Boost and LED Drive Efficiency

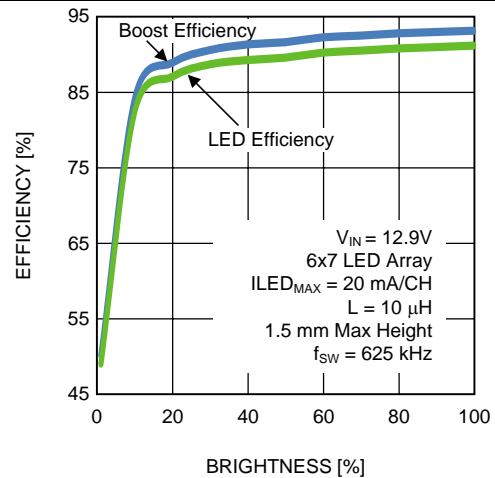

Figure 23. Boost and LED Drive Efficiency

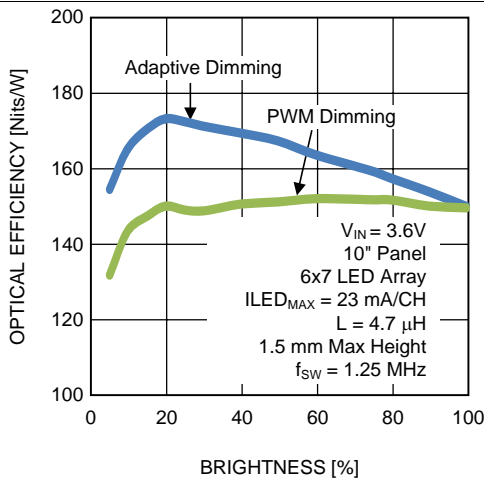

Figure 24. Optical Efficiency

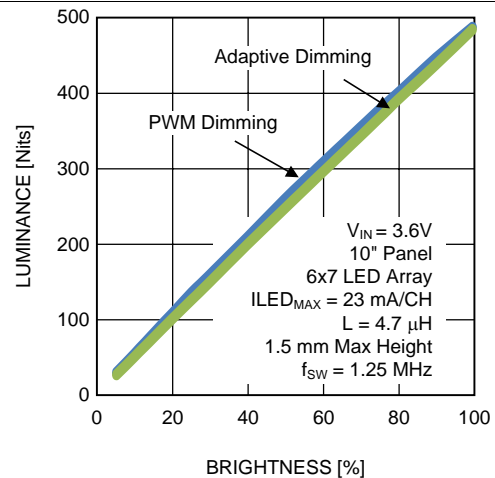
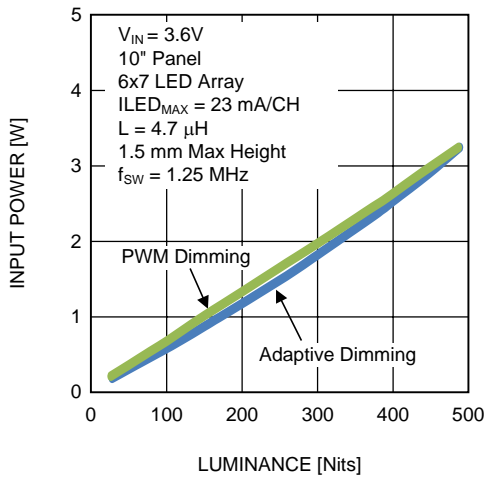
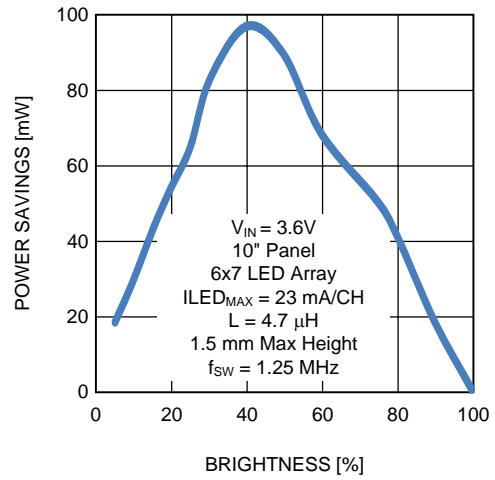

Figure 25. Luminance as a Function of Brightness

Unless otherwise specified:  $V_{IN} = 3.8\text{ V}$ ,  $C_{VLDO} = 10\ \mu\text{F}$ ,  $L_1 = 4.7\ \mu\text{H}$ ,  $C_{IN} = 2.2\ \mu\text{F}$ ,  $C_{OUT} = 4.7\ \mu\text{F}$ ,  $f_{SW} = 1.25\ \text{MHz}$



**Figure 26. Input Power as a Function of Brightness**



**Figure 27. Power Savings With Adaptive Dimming when Compared to PWM Dimming**

## 10 Power Supply Recommendations

The device is designed to operate from a VDD input voltage supply range from 2.7 V to 20 V. This input supply must be well regulated and able to withstand maximum input current and maintain stable voltage without voltage drop even at load transition condition (start-up or rapid brightness change). The resistance of the input supply rail must be low enough that the input current transient does not cause drop high enough in the LP8556 supply voltage that can cause false UVLO fault triggering.

If the input supply is located more than a few inches from the LP8556 device, additional bulk capacitance may be required in addition to the ceramic bypass capacitors. Depending on device EEPROM configuration and usage case the boost converter is configured to operate optimally with certain input voltage range.

## 11 Layout

### 11.1 Layout Guidelines

[Figure 28](#) and [Figure 29](#) follow proper layout guidelines and should be used as a guide for laying out the LP8556 circuit.

The LP8556 inductive boost converter has a high switched voltage at the SW pin, and a step current through the Schottky diode and output capacitor each switching cycle. The high switching voltage can create interference into nearby nodes due to electric field coupling ( $I = C \times dV/dt$ ). The large step current through the diode and the output capacitor can cause a large voltage spike at the SW and VBOOST pins due to parasitic inductance in the step current conducting path ( $V = L \times di/dt$ ). Board layout guidelines are geared towards minimizing this electric field coupling and conducted noise.

The following list details the main (layout sensitive) areas of the device inductive boost converter in order of decreasing importance:

#### 1. Boost Output Capacitor Placement

- Because the output capacitor is in the path of the inductor current discharge path, there is a high-current step from 0 to IPEAK each time the switch turns off and the Schottky diode turns on. Any inductance along this series path from the diodes cathode, through COUT, and back into the LP8556 GND pin contributes to voltage spikes ( $V_{SPIKE} = LP\_ \times di/dt$ ) at SW and OUT. These spikes can potentially over-voltage the SW and VBOOST pins, or feed through to GND. To avoid this, COUT+ must be connected as close to the cathode of the Schottky diode as possible, and COUT– must be connected as close to the LP8556 GND bumps as possible. The best placement for COUT is on the same layer as the LP8556 to avoid any vias that can add excessive series inductance.

#### 2. Schottky Diode Placement

- In the device boost circuit the Schottky diode is in the path of the inductor current discharge. As a result the Schottky diode has a high-current step from 0 to IPEAK each time the switch turns off and the diode turns on. Any inductance in series with the diode causes a voltage spike ( $V_{SPIKE} = LP\_ \times di/dt$ ) at SW and OUT. This can potentially over-voltage the SW pin, or feed through to VOUT and through the output capacitor, into GND. Connecting the anode of the diode as close to the SW pin as possible, and connecting the cathode of the diode as close to COUT+ as possible reduces the inductance (LP\_) and minimize these voltage spikes.

#### 3. Boost Input/VDD Capacitor Placement

- The LP8556 input capacitor filters the inductor current ripple and the internal MOSFET driver currents. The inductor current ripple can add input voltage ripple due to any series resistance in the input power path. The MOSFET driver currents can add voltage spikes on the input due to the inductance in series with the VIN/VDD and the input capacitor. Close placement of the input capacitor to the VDD pin and to the GND pin is critical because any series inductance between VIN/VDD and CIN+ or CIN– and GND can create voltage spikes that could appear on the VIN/VDD supply line and GND.
- Close placement of the input capacitor at the input side of the inductor is also critical. The source impedance (inductance and resistance) from the input supply, along with the input capacitor of the LP8556, forms a series RLC circuit. If the output resistance from the source is low enough, the circuit is underdamped and will have a resonant frequency (typically the case).
- Depending on the size of LS, the resonant frequency could occur below, close to, or above the switching frequency of the LP8556. This can cause the supply current ripple to be:

## Layout Guidelines (continued)

- Approximately equal to the inductor current ripple when the resonant frequency occurs well above the LP8556 switching frequency.
- Greater than the inductor current ripple when the resonant frequency occurs near the switching frequency.
- Less than the inductor current ripple when the resonant frequency occurs well below the switching frequency.

## 11.2 Layout Examples

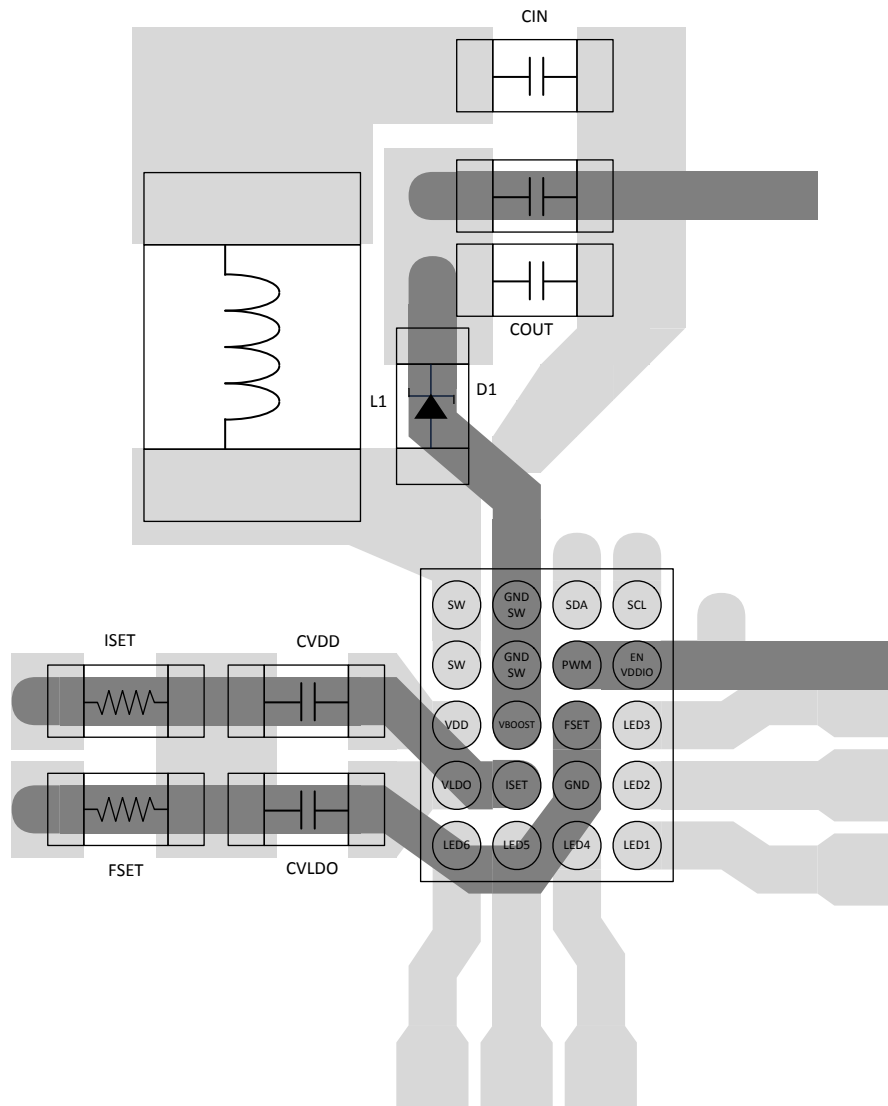

**Figure 28. DSBGA Layout**

Layout Examples (continued)

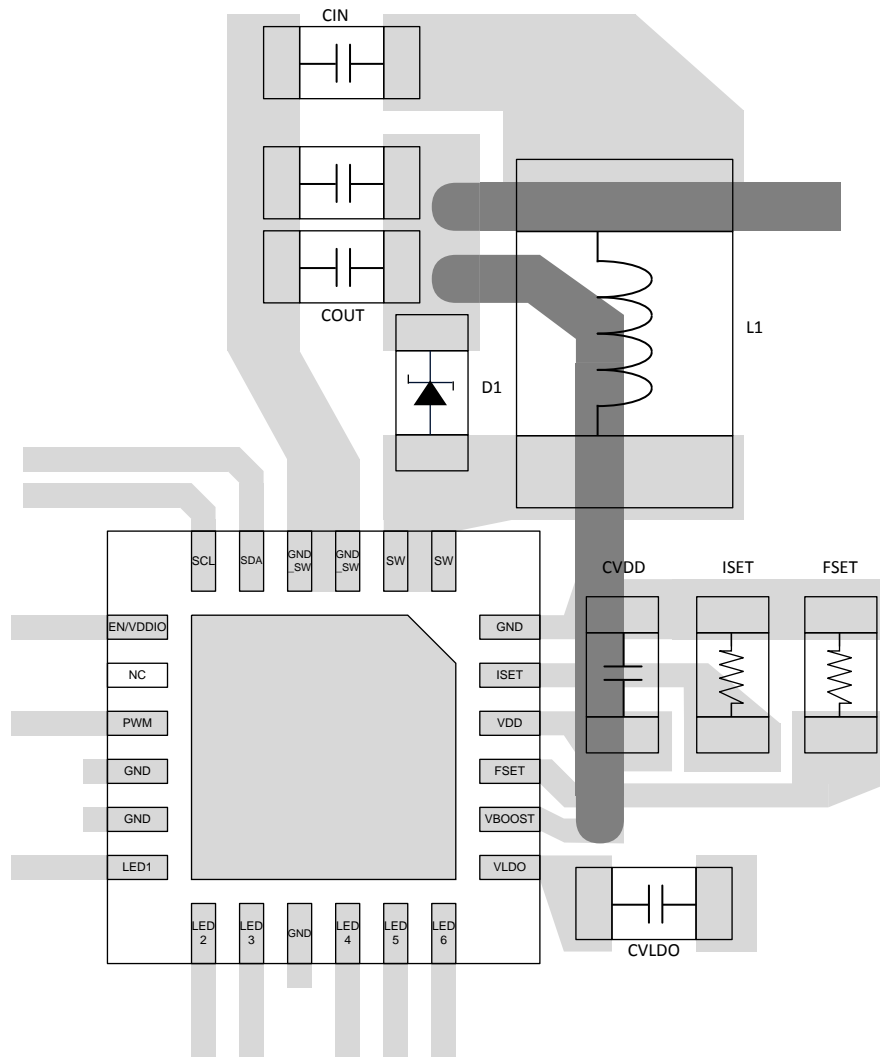

Figure 29. WQFN Layout

## 12 Device and Documentation Support

### 12.1 Receiving Notification of Documentation Updates

To receive notification of documentation updates, navigate to the device product folder on ti.com. In the upper right corner, click on *Alert me* to register and receive a weekly digest of any product information that has changed. For change details, review the revision history included in any revised document.

### 12.2 Community Resources

The following links connect to TI community resources. Linked contents are provided "AS IS" by the respective contributors. They do not constitute TI specifications and do not necessarily reflect TI's views; see TI's [Terms of Use](#).

**TI E2E™ Online Community** *TI's Engineer-to-Engineer (E2E) Community*. Created to foster collaboration among engineers. At e2e.ti.com, you can ask questions, share knowledge, explore ideas and help solve problems with fellow engineers.

**Design Support** *TI's Design Support* Quickly find helpful E2E forums along with design support tools and contact information for technical support.

### 12.3 Trademarks

E2E is a trademark of Texas Instruments.  
All other trademarks are the property of their respective owners.

### 12.4 Electrostatic Discharge Caution



These devices have limited built-in ESD protection. The leads should be shorted together or the device placed in conductive foam during storage or handling to prevent electrostatic damage to the MOS gates.

### 12.5 Glossary

[SLYZ022](#) — *TI Glossary*.

This glossary lists and explains terms, acronyms, and definitions.

## 13 Mechanical, Packaging, and Orderable Information

The following pages include mechanical, packaging, and orderable information. This information is the most current data available for the designated devices. This data is subject to change without notice and revision of this document. For browser-based versions of this data sheet, refer to the left-hand navigation.

**PACKAGING INFORMATION**

Orderable Device	Status (1)	Package Type	Package Drawing	Pins	Package Qty	Eco Plan (2)	Lead/Ball Finish (6)	MSL Peak Temp (3)	Op Temp (°C)	Device Marking (4/5)	Samples
LP8556SQ-E00/NOPB	ACTIVE	WQFN	RTW	24	1000	Green (RoHS & no Sb/Br)	NIPDAU   SN	Level-1-260C-UNLIM	-30 to 85	L8556E0	<a href="#">Samples</a>
LP8556SQ-E08/NOPB	ACTIVE	WQFN	RTW	24	1000	Green (RoHS & no Sb/Br)	NIPDAU   SN	Level-1-260C-UNLIM	-30 to 85	L8556E8	<a href="#">Samples</a>
LP8556SQ-E09/NOPB	ACTIVE	WQFN	RTW	24	1000	Green (RoHS & no Sb/Br)	NIPDAU   SN	Level-1-260C-UNLIM	-30 to 85	L8556E9	<a href="#">Samples</a>
LP8556SQE-E00/NOPB	ACTIVE	WQFN	RTW	24	250	Green (RoHS & no Sb/Br)	NIPDAU   SN	Level-1-260C-UNLIM	-30 to 85	L8556E0	<a href="#">Samples</a>
LP8556SQE-E08/NOPB	ACTIVE	WQFN	RTW	24	250	Green (RoHS & no Sb/Br)	NIPDAU   SN	Level-1-260C-UNLIM	-30 to 85	L8556E8	<a href="#">Samples</a>
LP8556SQE-E09/NOPB	ACTIVE	WQFN	RTW	24	250	Green (RoHS & no Sb/Br)	NIPDAU   SN	Level-1-260C-UNLIM	-30 to 85	L8556E9	<a href="#">Samples</a>
LP8556SQX-E00/NOPB	ACTIVE	WQFN	RTW	24	4500	Green (RoHS & no Sb/Br)	NIPDAU   SN	Level-1-260C-UNLIM	-30 to 85	L8556E0	<a href="#">Samples</a>
LP8556SQX-E08/NOPB	ACTIVE	WQFN	RTW	24	4500	Green (RoHS & no Sb/Br)	NIPDAU   SN	Level-1-260C-UNLIM	-30 to 85	L8556E8	<a href="#">Samples</a>
LP8556SQX-E09/NOPB	ACTIVE	WQFN	RTW	24	4500	Green (RoHS & no Sb/Br)	NIPDAU   SN	Level-1-260C-UNLIM	-30 to 85	L8556E9	<a href="#">Samples</a>
LP8556TME-E02/NOPB	ACTIVE	DSBGA	YFQ	20	250	Green (RoHS & no Sb/Br)	SNAGCU	Level-1-260C-UNLIM	-30 to 85	56E2	<a href="#">Samples</a>
LP8556TME-E03/NOPB	ACTIVE	DSBGA	YFQ	20	250	Green (RoHS & no Sb/Br)	SNAGCU	Level-1-260C-UNLIM	-30 to 85	56E3	<a href="#">Samples</a>
LP8556TME-E04/NOPB	ACTIVE	DSBGA	YFQ	20	250	Green (RoHS & no Sb/Br)	SNAGCU	Level-1-260C-UNLIM	-30 to 85	56E4	<a href="#">Samples</a>
LP8556TME-E05/NOPB	ACTIVE	DSBGA	YFQ	20	250	Green (RoHS & no Sb/Br)	SNAGCU	Level-1-260C-UNLIM	-30 to 85	56E5	<a href="#">Samples</a>
LP8556TME-E06/NOPB	ACTIVE	DSBGA	YFQ	20	250	Green (RoHS & no Sb/Br)	SNAGCU	Level-1-260C-UNLIM	-30 to 85	56E6	<a href="#">Samples</a>
LP8556TME-E09/NOPB	ACTIVE	DSBGA	YFQ	20	250	Green (RoHS & no Sb/Br)	SNAGCU	Level-1-260C-UNLIM	-30 to 85	56E9	<a href="#">Samples</a>
LP8556TME-E11/NOPB	ACTIVE	DSBGA	YFQ	20	250	Green (RoHS & no Sb/Br)	SNAGCU	Level-1-260C-UNLIM	-30 to 85	6E11	<a href="#">Samples</a>
LP8556TMX-E02/NOPB	ACTIVE	DSBGA	YFQ	20	3000	Green (RoHS & no Sb/Br)	SNAGCU	Level-1-260C-UNLIM	-30 to 85	56E2	<a href="#">Samples</a>

Orderable Device	Status (1)	Package Type	Package Drawing	Pins	Package Qty	Eco Plan (2)	Lead/Ball Finish (6)	MSL Peak Temp (3)	Op Temp (°C)	Device Marking (4/5)	Samples
LP8556TMX-E03/NOPB	ACTIVE	DSBGA	YFQ	20	3000	Green (RoHS & no Sb/Br)	SAC396   SNAGCU	Level-1-260C-UNLIM	-30 to 85	56E3	<a href="#">Samples</a>
LP8556TMX-E04/NOPB	ACTIVE	DSBGA	YFQ	20	3000	Green (RoHS & no Sb/Br)	SNAGCU	Level-1-260C-UNLIM	-30 to 85	56E4	<a href="#">Samples</a>
LP8556TMX-E05/NOPB	ACTIVE	DSBGA	YFQ	20	3000	Green (RoHS & no Sb/Br)	SNAGCU	Level-1-260C-UNLIM	-30 to 85	56E5	<a href="#">Samples</a>
LP8556TMX-E06/NOPB	ACTIVE	DSBGA	YFQ	20	3000	Green (RoHS & no Sb/Br)	SNAGCU	Level-1-260C-UNLIM	-30 to 85	56E6	<a href="#">Samples</a>
LP8556TMX-E09/NOPB	ACTIVE	DSBGA	YFQ	20	3000	Green (RoHS & no Sb/Br)	SNAGCU	Level-1-260C-UNLIM	-30 to 85	56E9	<a href="#">Samples</a>
LP8556TMX-E11/NOPB	ACTIVE	DSBGA	YFQ	20	3000	Green (RoHS & no Sb/Br)	SNAGCU	Level-1-260C-UNLIM	-30 to 85	6E11	<a href="#">Samples</a>

(1) The marketing status values are defined as follows:

**ACTIVE:** Product device recommended for new designs.

**LIFEBUY:** TI has announced that the device will be discontinued, and a lifetime-buy period is in effect.

**NRND:** Not recommended for new designs. Device is in production to support existing customers, but TI does not recommend using this part in a new design.

**PREVIEW:** Device has been announced but is not in production. Samples may or may not be available.

**OBSOLETE:** TI has discontinued the production of the device.

(2) **RoHS:** TI defines "RoHS" to mean semiconductor products that are compliant with the current EU RoHS requirements for all 10 RoHS substances, including the requirement that RoHS substance do not exceed 0.1% by weight in homogeneous materials. Where designed to be soldered at high temperatures, "RoHS" products are suitable for use in specified lead-free processes. TI may reference these types of products as "Pb-Free".

**RoHS Exempt:** TI defines "RoHS Exempt" to mean products that contain lead but are compliant with EU RoHS pursuant to a specific EU RoHS exemption.

**Green:** TI defines "Green" to mean the content of Chlorine (Cl) and Bromine (Br) based flame retardants meet JS709B low halogen requirements of <=1000ppm threshold. Antimony trioxide based flame retardants must also meet the <=1000ppm threshold requirement.

(3) MSL, Peak Temp. - The Moisture Sensitivity Level rating according to the JEDEC industry standard classifications, and peak solder temperature.

(4) There may be additional marking, which relates to the logo, the lot trace code information, or the environmental category on the device.

(5) Multiple Device Markings will be inside parentheses. Only one Device Marking contained in parentheses and separated by a "~" will appear on a device. If a line is indented then it is a continuation of the previous line and the two combined represent the entire Device Marking for that device.

(6) Lead/Ball Finish - Orderable Devices may have multiple material finish options. Finish options are separated by a vertical ruled line. Lead/Ball Finish values may wrap to two lines if the finish value exceeds the maximum column width.



**Important Information and Disclaimer:** The information provided on this page represents TI's knowledge and belief as of the date that it is provided. TI bases its knowledge and belief on information provided by third parties, and makes no representation or warranty as to the accuracy of such information. Efforts are underway to better integrate information from third parties. TI has taken and continues to take reasonable steps to provide representative and accurate information but may not have conducted destructive testing or chemical analysis on incoming materials and chemicals. TI and TI suppliers consider certain information to be proprietary, and thus CAS numbers and other limited information may not be available for release.

In no event shall TI's liability arising out of such information exceed the total purchase price of the TI part(s) at issue in this document sold by TI to Customer on an annual basis.

## TAPE AND REEL INFORMATION



### QUADRANT ASSIGNMENTS FOR PIN 1 ORIENTATION IN TAPE



\*All dimensions are nominal

Device	Package Type	Package Drawing	Pins	SPQ	Reel Diameter (mm)	Reel Width W1 (mm)	A0 (mm)	B0 (mm)	K0 (mm)	P1 (mm)	W (mm)	Pin1 Quadrant
LP8556SQ-E00/NOPB	WQFN	RTW	24	1000	180.0	12.4	4.25	4.25	1.15	8.0	12.0	Q1
LP8556SQ-E00/NOPB	WQFN	RTW	24	1000	178.0	12.4	4.3	4.3	1.3	8.0	12.0	Q1
LP8556SQ-E08/NOPB	WQFN	RTW	24	1000	178.0	12.4	4.3	4.3	1.3	8.0	12.0	Q1
LP8556SQ-E08/NOPB	WQFN	RTW	24	1000	180.0	12.4	4.25	4.25	1.15	8.0	12.0	Q1
LP8556SQ-E09/NOPB	WQFN	RTW	24	1000	178.0	12.4	4.3	4.3	1.3	8.0	12.0	Q1
LP8556SQ-E09/NOPB	WQFN	RTW	24	1000	180.0	12.4	4.25	4.25	1.15	8.0	12.0	Q1
LP8556SQE-E00/NOPB	WQFN	RTW	24	250	178.0	12.4	4.3	4.3	1.3	8.0	12.0	Q1
LP8556SQE-E00/NOPB	WQFN	RTW	24	250	180.0	12.4	4.25	4.25	1.15	8.0	12.0	Q1
LP8556SQE-E08/NOPB	WQFN	RTW	24	250	178.0	12.4	4.3	4.3	1.3	8.0	12.0	Q1
LP8556SQE-E08/NOPB	WQFN	RTW	24	250	180.0	12.4	4.25	4.25	1.15	8.0	12.0	Q1
LP8556SQE-E09/NOPB	WQFN	RTW	24	250	178.0	12.4	4.3	4.3	1.3	8.0	12.0	Q1
LP8556SQE-E09/NOPB	WQFN	RTW	24	250	180.0	12.4	4.25	4.25	1.15	8.0	12.0	Q1
LP8556SQX-E00/NOPB	WQFN	RTW	24	4500	330.0	12.4	4.3	4.3	1.3	8.0	12.0	Q1
LP8556SQX-E00/NOPB	WQFN	RTW	24	4500	330.0	12.4	4.25	4.25	1.15	8.0	12.0	Q1
LP8556SQX-E08/NOPB	WQFN	RTW	24	4500	330.0	12.4	4.3	4.3	1.3	8.0	12.0	Q1
LP8556SQX-E08/NOPB	WQFN	RTW	24	4500	330.0	12.4	4.25	4.25	1.15	8.0	12.0	Q1
LP8556SQX-E09/NOPB	WQFN	RTW	24	4500	330.0	12.4	4.3	4.3	1.3	8.0	12.0	Q1
LP8556TME-E02/NOPB	DSBGA	YFQ	20	250	178.0	8.4	1.83	2.49	0.76	4.0	8.0	Q1

Device	Package Type	Package Drawing	Pins	SPQ	Reel Diameter (mm)	Reel Width W1 (mm)	A0 (mm)	B0 (mm)	K0 (mm)	P1 (mm)	W (mm)	Pin1 Quadrant
LP8556TME-E03/NOPB	DSBGA	YFQ	20	250	178.0	8.4	1.83	2.49	0.76	4.0	8.0	Q1
LP8556TME-E04/NOPB	DSBGA	YFQ	20	250	178.0	8.4	1.83	2.49	0.76	4.0	8.0	Q1
LP8556TME-E05/NOPB	DSBGA	YFQ	20	250	178.0	8.4	1.83	2.49	0.76	4.0	8.0	Q1
LP8556TME-E06/NOPB	DSBGA	YFQ	20	250	178.0	8.4	1.83	2.49	0.76	4.0	8.0	Q1
LP8556TME-E09/NOPB	DSBGA	YFQ	20	250	178.0	8.4	1.83	2.49	0.76	4.0	8.0	Q1
LP8556TME-E11/NOPB	DSBGA	YFQ	20	250	178.0	8.4	1.83	2.49	0.76	4.0	8.0	Q1
LP8556TMX-E02/NOPB	DSBGA	YFQ	20	3000	178.0	8.4	1.83	2.49	0.76	4.0	8.0	Q1
LP8556TMX-E03/NOPB	DSBGA	YFQ	20	3000	178.0	8.4	1.83	2.49	0.76	4.0	8.0	Q1
LP8556TMX-E03/NOPB	DSBGA	YFQ	20	3000	178.0	8.4	1.83	2.49	0.76	4.0	8.0	Q1
LP8556TMX-E04/NOPB	DSBGA	YFQ	20	3000	178.0	8.4	1.83	2.49	0.76	4.0	8.0	Q1
LP8556TMX-E04/NOPB	DSBGA	YFQ	20	3000	178.0	8.4	1.83	2.49	0.76	4.0	8.0	Q1
LP8556TMX-E05/NOPB	DSBGA	YFQ	20	3000	178.0	8.4	1.83	2.49	0.76	4.0	8.0	Q1
LP8556TMX-E05/NOPB	DSBGA	YFQ	20	3000	178.0	8.4	1.83	2.49	0.76	4.0	8.0	Q1
LP8556TMX-E06/NOPB	DSBGA	YFQ	20	3000	178.0	8.4	1.83	2.49	0.76	4.0	8.0	Q1
LP8556TMX-E06/NOPB	DSBGA	YFQ	20	3000	178.0	8.4	1.83	2.49	0.76	4.0	8.0	Q1
LP8556TMX-E09/NOPB	DSBGA	YFQ	20	3000	178.0	8.4	1.83	2.49	0.76	4.0	8.0	Q1
LP8556TMX-E09/NOPB	DSBGA	YFQ	20	3000	178.0	8.4	1.83	2.49	0.76	4.0	8.0	Q1
LP8556TMX-E11/NOPB	DSBGA	YFQ	20	3000	178.0	8.4	1.83	2.49	0.76	4.0	8.0	Q1
LP8556TMX-E11/NOPB	DSBGA	YFQ	20	3000	178.0	8.4	1.83	2.49	0.76	4.0	8.0	Q1

## TAPE AND REEL BOX DIMENSIONS

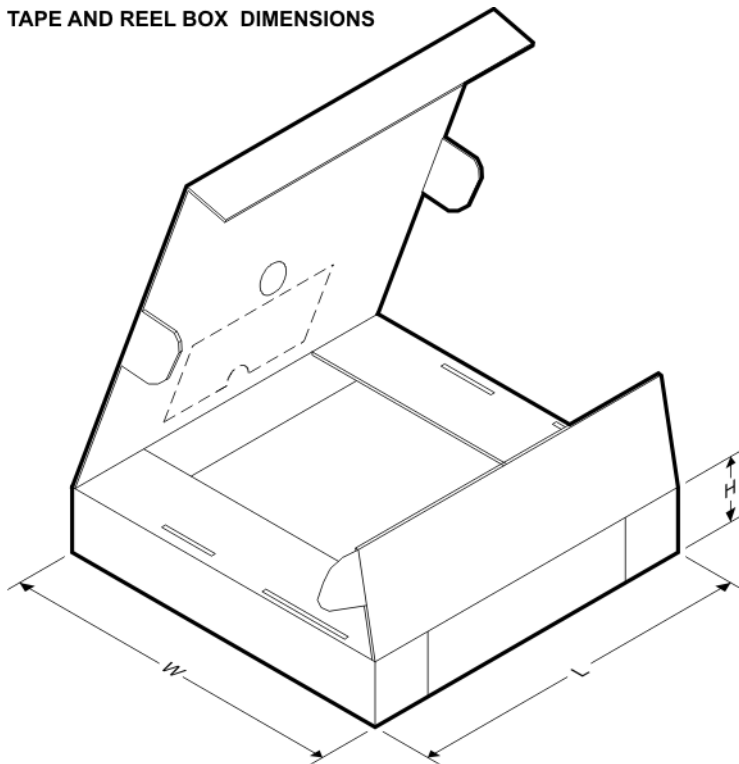

\*All dimensions are nominal

Device	Package Type	Package Drawing	Pins	SPQ	Length (mm)	Width (mm)	Height (mm)
LP8556SQ-E00/NOPB	WQFN	RTW	24	1000	210.0	185.0	35.0
LP8556SQ-E00/NOPB	WQFN	RTW	24	1000	210.0	185.0	35.0
LP8556SQ-E08/NOPB	WQFN	RTW	24	1000	210.0	185.0	35.0
LP8556SQ-E08/NOPB	WQFN	RTW	24	1000	210.0	185.0	35.0
LP8556SQ-E09/NOPB	WQFN	RTW	24	1000	210.0	185.0	35.0
LP8556SQ-E09/NOPB	WQFN	RTW	24	1000	210.0	185.0	35.0
LP8556SQE-E00/NOPB	WQFN	RTW	24	250	210.0	185.0	35.0
LP8556SQE-E00/NOPB	WQFN	RTW	24	250	210.0	185.0	35.0
LP8556SQE-E08/NOPB	WQFN	RTW	24	250	210.0	185.0	35.0
LP8556SQE-E08/NOPB	WQFN	RTW	24	250	210.0	185.0	35.0
LP8556SQE-E09/NOPB	WQFN	RTW	24	250	210.0	185.0	35.0
LP8556SQE-E09/NOPB	WQFN	RTW	24	250	210.0	185.0	35.0
LP8556SQX-E00/NOPB	WQFN	RTW	24	4500	367.0	367.0	35.0
LP8556SQX-E00/NOPB	WQFN	RTW	24	4500	367.0	367.0	35.0
LP8556SQX-E08/NOPB	WQFN	RTW	24	4500	367.0	367.0	35.0
LP8556SQX-E08/NOPB	WQFN	RTW	24	4500	367.0	367.0	35.0
LP8556SQX-E09/NOPB	WQFN	RTW	24	4500	367.0	367.0	35.0
LP8556TME-E02/NOPB	DSBGA	YFQ	20	250	210.0	185.0	35.0
LP8556TME-E03/NOPB	DSBGA	YFQ	20	250	210.0	185.0	35.0
LP8556TME-E04/NOPB	DSBGA	YFQ	20	250	210.0	185.0	35.0
LP8556TME-E05/NOPB	DSBGA	YFQ	20	250	210.0	185.0	35.0
LP8556TME-E06/NOPB	DSBGA	YFQ	20	250	210.0	185.0	35.0
LP8556TME-E09/NOPB	DSBGA	YFQ	20	250	210.0	185.0	35.0
LP8556TME-E11/NOPB	DSBGA	YFQ	20	250	210.0	185.0	35.0
LP8556TMX-E02/NOPB	DSBGA	YFQ	20	3000	210.0	185.0	35.0
LP8556TMX-E03/NOPB	DSBGA	YFQ	20	3000	220.0	220.0	35.0
LP8556TMX-E03/NOPB	DSBGA	YFQ	20	3000	210.0	185.0	35.0
LP8556TMX-E04/NOPB	DSBGA	YFQ	20	3000	210.0	185.0	35.0
LP8556TMX-E04/NOPB	DSBGA	YFQ	20	3000	220.0	220.0	35.0
LP8556TMX-E05/NOPB	DSBGA	YFQ	20	3000	210.0	185.0	35.0
LP8556TMX-E05/NOPB	DSBGA	YFQ	20	3000	220.0	220.0	35.0
LP8556TMX-E06/NOPB	DSBGA	YFQ	20	3000	220.0	220.0	35.0
LP8556TMX-E06/NOPB	DSBGA	YFQ	20	3000	210.0	185.0	35.0
LP8556TMX-E09/NOPB	DSBGA	YFQ	20	3000	220.0	220.0	35.0
LP8556TMX-E09/NOPB	DSBGA	YFQ	20	3000	210.0	185.0	35.0
LP8556TMX-E11/NOPB	DSBGA	YFQ	20	3000	220.0	220.0	35.0
LP8556TMX-E11/NOPB	DSBGA	YFQ	20	3000	210.0	185.0	35.0

RTW0024A



PACKAGE OUTLINE

WQFN - 0.8 mm max height

PLASTIC QUAD FLATPACK - NO LEAD

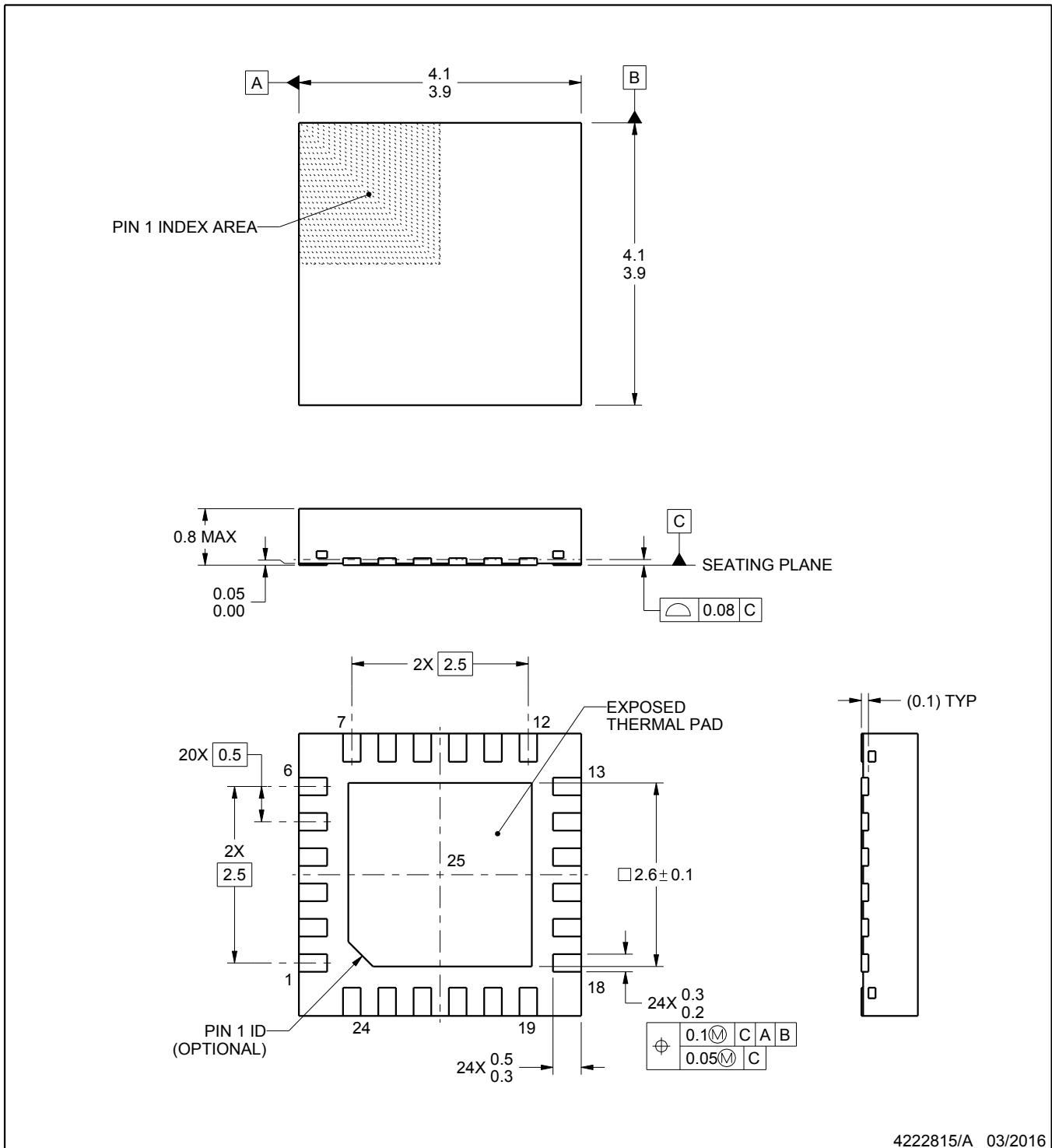

4222815/A 03/2016

NOTES:

1. All linear dimensions are in millimeters. Any dimensions in parenthesis are for reference only. Dimensioning and tolerancing per ASME Y14.5M.
2. This drawing is subject to change without notice.
3. The package thermal pad must be soldered to the printed circuit board for thermal and mechanical performance.

# EXAMPLE BOARD LAYOUT

RTW0024A

WQFN - 0.8 mm max height

PLASTIC QUAD FLATPACK - NO LEAD



LAND PATTERN EXAMPLE  
SCALE:15X

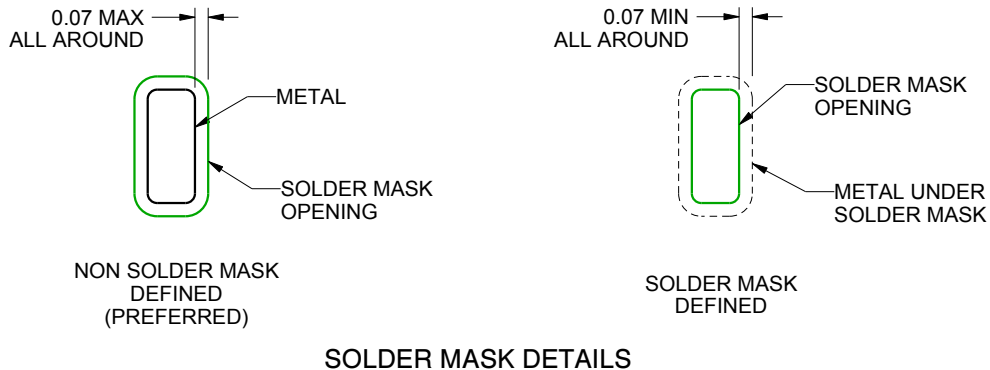

4222815/A 03/2016

NOTES: (continued)

4. This package is designed to be soldered to a thermal pad on the board. For more information, see Texas Instruments literature number SLUA271 ([www.ti.com/lit/sl原因271](http://www.ti.com/lit/sl原因271)).

# EXAMPLE STENCIL DESIGN

RTW0024A

WQFN - 0.8 mm max height

PLASTIC QUAD FLATPACK - NO LEAD

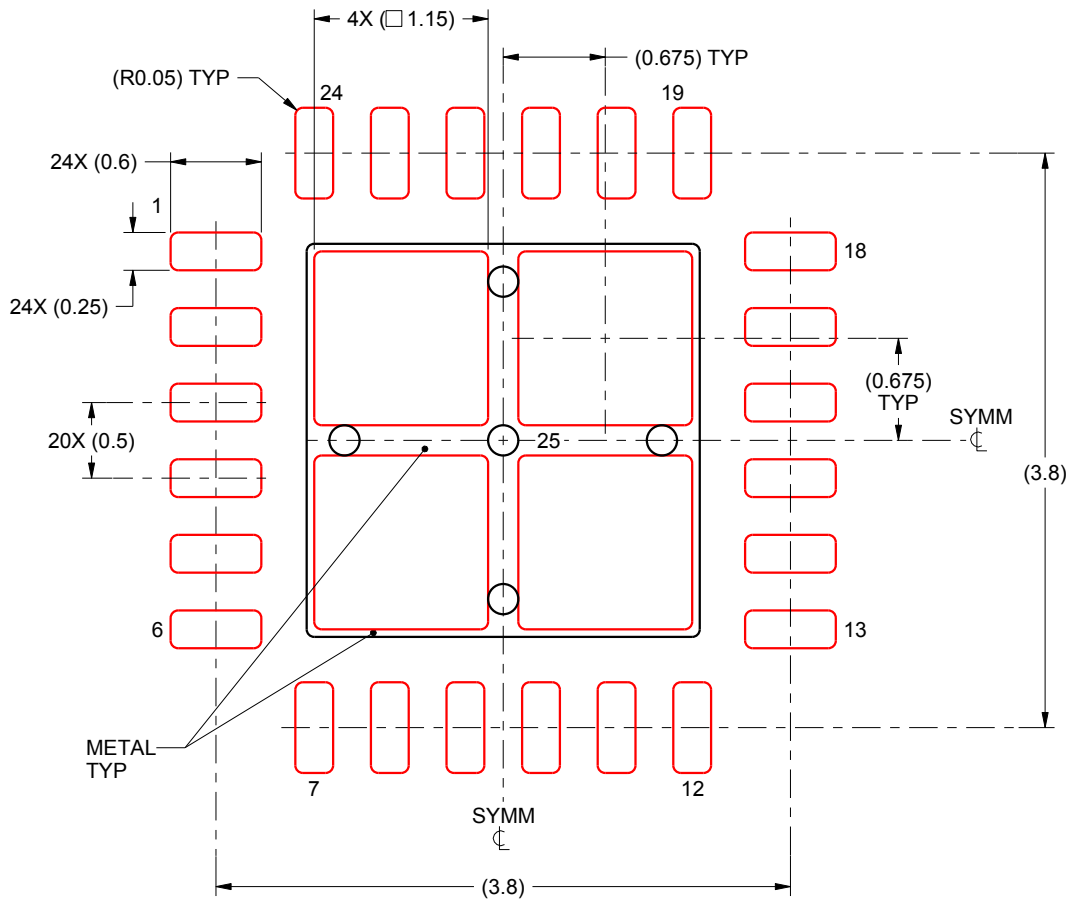

**SOLDER PASTE EXAMPLE**  
BASED ON 0.125 mm THICK STENCIL

EXPOSED PAD 25:  
78% PRINTED SOLDER COVERAGE BY AREA UNDER PACKAGE  
SCALE:20X

4222815/A 03/2016

NOTES: (continued)

5. Laser cutting apertures with trapezoidal walls and rounded corners may offer better paste release. IPC-7525 may have alternate design recommendations.

YFQ0020

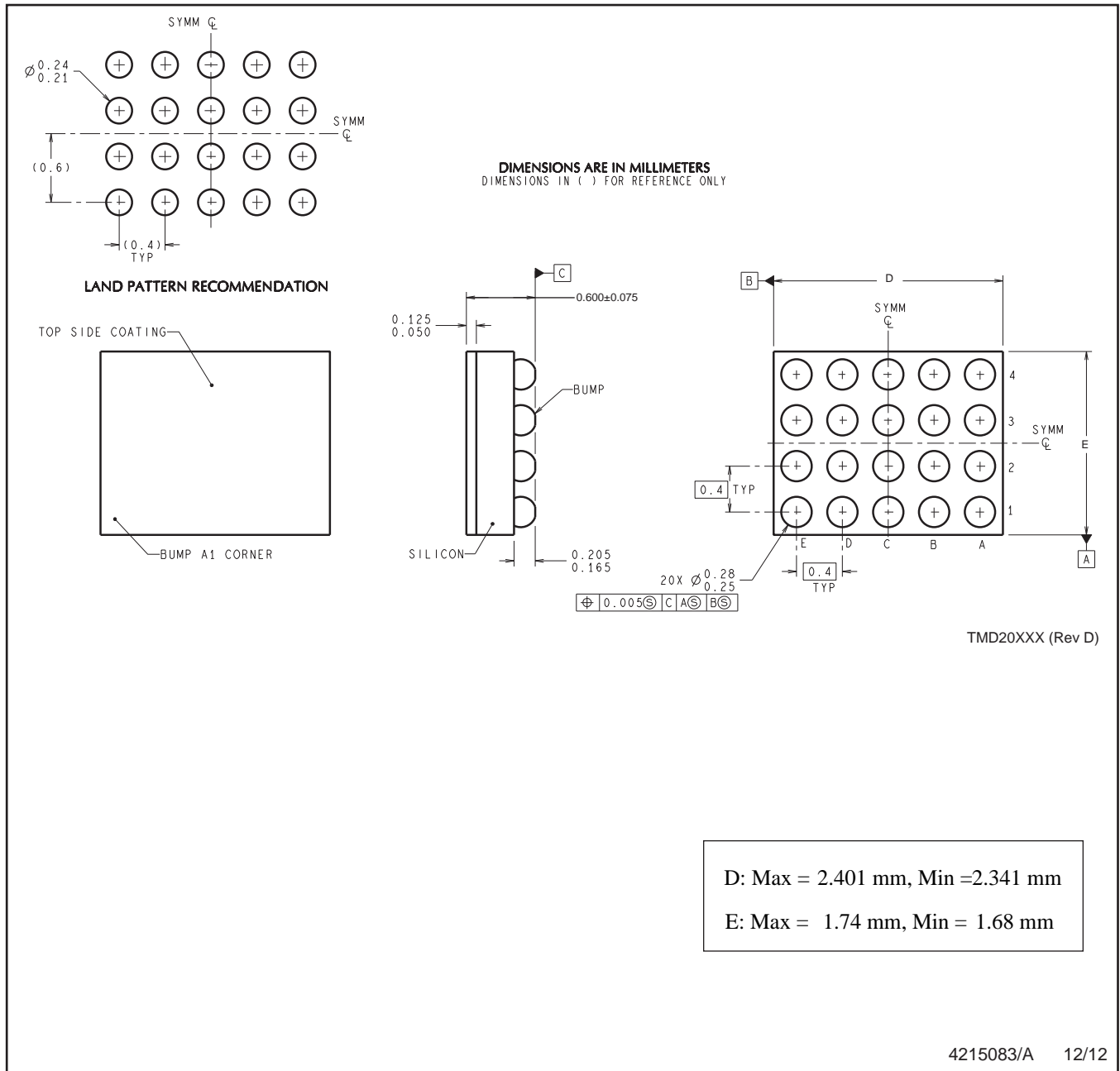

NOTES: A. All linear dimensions are in millimeters. Dimensioning and tolerancing per ASME Y14.5M-1994.  
 B. This drawing is subject to change without notice.



## IMPORTANT NOTICE AND DISCLAIMER

TI PROVIDES TECHNICAL AND RELIABILITY DATA (INCLUDING DATASHEETS), DESIGN RESOURCES (INCLUDING REFERENCE DESIGNS), APPLICATION OR OTHER DESIGN ADVICE, WEB TOOLS, SAFETY INFORMATION, AND OTHER RESOURCES "AS IS" AND WITH ALL FAULTS, AND DISCLAIMS ALL WARRANTIES, EXPRESS AND IMPLIED, INCLUDING WITHOUT LIMITATION ANY IMPLIED WARRANTIES OF MERCHANTABILITY, FITNESS FOR A PARTICULAR PURPOSE OR NON-INFRINGEMENT OF THIRD PARTY INTELLECTUAL PROPERTY RIGHTS.

These resources are intended for skilled developers designing with TI products. You are solely responsible for (1) selecting the appropriate TI products for your application, (2) designing, validating and testing your application, and (3) ensuring your application meets applicable standards, and any other safety, security, or other requirements. These resources are subject to change without notice. TI grants you permission to use these resources only for development of an application that uses the TI products described in the resource. Other reproduction and display of these resources is prohibited. No license is granted to any other TI intellectual property right or to any third party intellectual property right. TI disclaims responsibility for, and you will fully indemnify TI and its representatives against, any claims, damages, costs, losses, and liabilities arising out of your use of these resources.

TI's products are provided subject to TI's Terms of Sale ([www.ti.com/legal/termsofsale.html](http://www.ti.com/legal/termsofsale.html)) or other applicable terms available either on [ti.com](http://ti.com) or provided in conjunction with such TI products. TI's provision of these resources does not expand or otherwise alter TI's applicable warranties or warranty disclaimers for TI products.

Mailing Address: Texas Instruments, Post Office Box 655303, Dallas, Texas 75265  
Copyright © 2020, Texas Instruments Incorporated