

100323

Low Power Hex Bus Driver

General Description

The 100323 is a monolithic device containing six bus drivers capable of driving terminated lines with terminations as low as 25Ω. To reduce crosstalk, each output has its own respective ground connection. Transition times were designed to be longer than on other F100K devices. The driver itself performs the positive logic AND of a data input (D₁–D₆) and the OR of two select inputs (E and either DE₁, DE₂, or DE₃).

Enabling of data is possible in multiples of two, i.e., 2, 4 or all 6 paths. All inputs have 50 kΩ pull-down resistors.

The output voltage LOW level is designed to be more negative than normal ECL outputs (cut off state). This allows an

emitter-follower output transistor to turn off when the termination supply is –2.0V and thus present a high impedance to the data bus.

Features

- 50% power reduction of the 100123
- 2000V ESD protection
- –4.2V to –5.7V operating range
- Drives 25Ω load

Ordering Code:

Logic Symbol

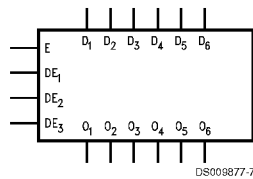

Pin Names	Description
D ₁ –D ₆	Data Inputs
DE ₁ –DE ₃	Dual Enable Inputs
E	Common Enable Input
O ₁ –O ₆	Data Outputs

Connection Diagrams

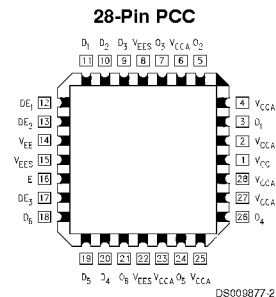
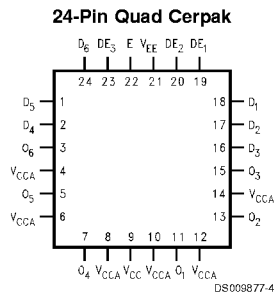
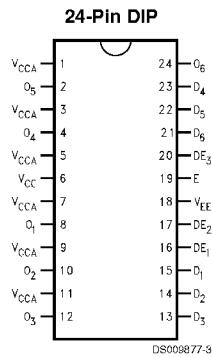

Logic Diagram

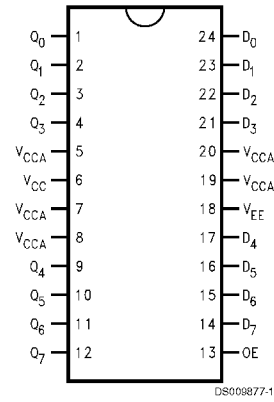

Truth Table

E	DE _n	D _n	D _{n+1}	O _n	O _{n+1}
L	L	X	X	Cutoff	Cutoff
X	H	L	L	Cutoff	Cutoff
X	H	L	H	Cutoff	H
X	H	H	L	H	Cutoff
X	H	H	H	H	H
H	X	L	L	Cutoff	Cutoff
H	X	L	H	Cutoff	H
H	X	H	L	H	Cutoff
H	X	H	H	H	H

H = High
 Cutoff = Lower-than-LOW state
 L = Low
 X = Don't Care

Absolute Maximum Ratings (Note 1)

Storage Temperature	-65°C to +150°C
Maximum Junction Temperature	
Ceramic	+175°C
Plastic	+150°C
V _{EE} Pin Potential to Ground Pin	-7.0V to +0.5V
Input Voltage (DC)	V _{EE} to +0.5V
Output Current (DC Output High)	-50 mA
ESD	≥2000V

Recommended Operating Conditions

Case Temperature	
Commercial	0°C to +85°C
Military	-55°C to +125°C
Supply Voltage (V _{EE})	-5.7V to -4.2V

Note 1: Absolute maximum ratings are values beyond which the device may be damaged or have its useful life impaired. Functional operation under these conditions is not implied.

Note 2: ESD testing conforms to MIL-STD-883, Method 3015.

Commercial Version

DC Electrical Characteristics

V_{EE} = -4.2V to -5.7V, V_{CC} = V_{CCA} = GND, T_C = 0°C to +85°C (Note 3)

Symbol	Parameter	Min	Typ	Max	Units	Conditions	
V _{IH}	Input HIGH Voltage	-1165		-870	mV	Guaranteed High Signal for ALL Inputs	
V _{IL}	Input LOW Voltage	-1830		-1475	mV	Guaranteed Low Signal for ALL Inputs	
V _{OH}	Output HIGH Voltage	-1025	-955	-870	mV	V _{IN} = V _{IH (max)} or V _{IL (min)}	Loading with 25Ω to -2.0V
V _{OHc}	Output HIGH Voltage	-1035			mV	V _{IN} = V _{IH (min)} or V _{IL (max)}	Loading with 25Ω to -2.0V
V _{OLZ}	Cut-Off LOW Voltage			-1950	mV	V _{IN} = V _{IH (min)} or V _{IL (max)}	Loading with 25Ω to -2.0V
I _{IL}	Input LOW Current	0.50			μA	V _{IN} = V _{IL (min)}	
I _{IH}	Input HIGH Current			240	μA	V _{IN} = V _{IH (max)}	
I _{EE}	Power Supply Current	-121	-91	-57	mA	Inputs Open	

Note 3: The specified limits represent "worst case" values for the parameter. Since these values normally occur at the temperature extremes, additional noise immunity and guardbanding can be achieved by decreasing the allowable system operating ranges. Conditions for testing shown in the tables are chosen to guarantee operation under "worst case" conditions.

DIP AC Electrical Characteristics

V_{EE} = -4.2V to -5.7V, V_{CC} = V_{CCA} = GND

Symbol	Parameter	T _C = 0°C		T _C = +25°C		T _C = +85°C		Units	Conditions
		Min	Max	Min	Max	Min	Max		
t _{PZH}	Propagation Delay	1.90	3.60	1.90	3.60	2.00	3.80	ns	Figures 1, 2
t _{PHZ}	Data to Output	1.30	2.70	1.30	2.70	1.50	2.70		
t _{PZH}	Propagation Delay	1.90	3.60	1.90	3.60	2.00	3.90	ns	
t _{PHZ}	Dual Enable to Output	1.60	3.00	1.60	3.00	1.70	3.40		
t _{PZH}	Propagation Delay	1.80	3.50	1.80	3.50	2.00	3.80	ns	
t _{PHZ}	Common Enable to Output	1.50	2.90	1.50	2.90	1.60	3.00		
t _{TZH}	Transition Time	0.50	1.80	0.50	1.80	0.50	1.80	ns	
t _{THZ}	20% to 80%, 80% to 20%	0.35	1.40	0.35	1.40	0.35	1.40		

PCC and Cerpak AC Electrical Characteristics

$V_{EE} = -4.2V$ to $-5.7V$, $V_{CC} = V_{CCA} = GND$

Symbol	Parameter	$T_C = 0^\circ C$		$T_C = +25^\circ C$		$T_C = +85^\circ C$		Units	Conditions
		Min	Max	Min	Max	Min	Max		
t_{PZH}	Propagation Delay	1.90	3.40	1.90	3.40	2.00	3.60	ns	Figures 1, 2
t_{PHZ}	Data to Output	1.30	2.50	1.30	2.50	1.50	2.70	ns	
t_{PZH}	Propagation Delay	1.90	3.40	1.90	3.40	2.00	3.70	ns	
t_{PHZ}	Dual Enable to Output	1.60	2.80	1.60	2.80	1.70	3.00	ns	
t_{PZH}	Propagation Delay	1.80	3.30	1.80	3.30	2.00	3.60	ns	
t_{PHZ}	Common Enable to Output	1.50	2.70	1.50	2.70	1.60	2.80	ns	
t_{TZH}	Transition Time	0.50	1.70	0.50	1.70	0.50	1.70	ns	
t_{THZ}	20% to 80%, 80% to 20%	0.35	1.30	0.35	1.20	0.35	1.30	ns	

Note 4: The specified limits represent the "worst case" value for the parameter. Since these values normally occur at the temperature extremes, additional noise immunity and guard banding can be achieved by decreasing the allowable system operating ranges. Conditions for testing shown in the tables are chosen to guarantee operation under "worst case" conditions.

Military Version—Preliminary

DC Electrical Characteristics

$V_{EE} = -4.2V$ to $-5.7V$, $V_{CC} = V_{CCA} = GND$, $T_C = -55^\circ C$ to $+125^\circ C$

Symbol	Parameter	Min	Max	Units	T_C	Conditions	Notes	
V_{OH}	Output HIGH Voltage	-1025	-870	mV	$0^\circ C$ to $+125^\circ C$	$V_{IN} = V_{IH(max)}$ or $V_{IL(min)}$	Loading with 25Ω to $-2.0V$	(Notes 5, 6, 7)
		-1085	-870	mV	$-55^\circ C$			
V_{OHC}	Output HIGH Voltage	-1035		mV	$0^\circ C$ to $+125^\circ C$	$V_{IN} = V_{IH(min)}$ or $V_{IL(max)}$	Loading with 25Ω to $-2.0V$	(Notes 5, 6, 7)
		-1085		mV	$-55^\circ C$			
V_{OLC}	Output LOW Voltage		-1610	mV	$0^\circ C$ to $+125^\circ C$			
			-1555	MV	$-55^\circ C$			
V_{OLZ}	Cut-Off LOW Voltage		-1950	mV	$0^\circ C$ to $+125^\circ C$	$V_{IN} = V_{IH(min)}$ or $V_{IL(max)}$	Loading with 25Ω to $-2.0V$	(Notes 5, 6, 7)
			-1850	mV	$-55^\circ C$			
V_{IH}	Input HIGH Voltage	-1165	-870	mV	$-55^\circ C$ to $+125^\circ C$	Guaranteed HIGH Signal for All Inputs		(Notes 5, 6, 7, 8)
V_{IL}	Input LOW Voltage	-1830	-1475	mV	$-55^\circ C$ to $+125^\circ C$	Guaranteed LOW Signal for All Inputs		(Notes 5, 6, 7, 8)
I_{IL}	Input LOW Current	0.50		μA	$-55^\circ C$ to $+125^\circ C$	$V_{EE} = 4.2V$, $V_{IN} = V_{IL(min)}$		(Notes 5, 6, 7)
I_{IH}	Input HIGH Current		240	μA	$0^\circ C$ to $+125^\circ C$	$V_{EE} = -5.7V$, $V_{IN} = V_{IH(max)}$		(Notes 5, 6, 7)
			340	μA	$-55^\circ C$			
I_{EE}	Power Supply Current	-145 -150	-55	mA	$-55^\circ C$ to $+125^\circ C$	Inputs Open $V_{EE} = -4.2V$ to $-4.8V$ $V_{EE} = -4.2V$ to $-5.7V$		(Notes 5, 6, 7)

Note 5: F100K 300 Series cold temperature testing is performed by temperature soaking (to guarantee junction temperature equals $-55^\circ C$), then testing immediately without allowing for the junction temperature to stabilize due to heat dissipation after power-up. This provides "cold start" specs which can be considered a worst case condition at cold temperatures.

Note 6: Screen tested 100% on each device at $-55^\circ C$, $+25^\circ C$, and $+125^\circ C$, Subgroups 1, 2, 3, 7, and 8.

Note 7: Sample tested (Method 5005, Table I) on each manufactured lot at $-55^\circ C$, $+25^\circ C$, and $+125^\circ C$, Subgroups A1, 2, 3, 7, and 8.

Note 8: Guaranteed by applying specified input condition and testing V_{OH}/V_{OL} .

AC Electrical Characteristics—All Packages

$V_{EE} = -4.2V$ to $-5.7V$, $V_{CC} = V_{CCA} = GND$

Symbol	Parameter	$T_C = -55^\circ C$		$T_C = +25^\circ C$		$T_C = +125^\circ C$		Units	Conditions
		Min	Max	Min	Max	Min	Max		
t_{PZH}	Propagation Delay	1.70	4.00	1.70	4.00	1.80	4.20	ns	Figures 1, 2
t_{PHZ}	Data to Output	1.10	3.10	1.10	3.10	1.30	3.10		
t_{PZH}	Propagation Delay	1.70	4.00	1.70	4.00	1.80	4.30	ns	
t_{PHZ}	Data Enable to Output	1.40	3.40	1.40	3.40	1.50	3.80		
t_{PZH}	Propagation Delay	1.60	3.90	1.60	3.90	1.80	4.20	ns	
t_{PHZ}	Common Enable to Output	1.30	3.30	1.30	3.30	1.40	3.40		
t_{TZH}	Transition Time	0.40	2.20	0.40	2.20	0.40	2.20	ns	
t_{THZ}	20% to 80%, 80% to 20%	0.25	1.80	0.25	1.80	0.25	1.80		

Note 9: The specified limits represent the "worst case" value for the parameter. Since these "worst case" values normally occur at the temperature extremes, additional noise immunity and guard banding can be achieved by decreasing the allowable system operating ranges.

Note 10: Conditions for testing shown in the tables are chosen to guarantee operation under "worst case" conditions.

Test Circuitry

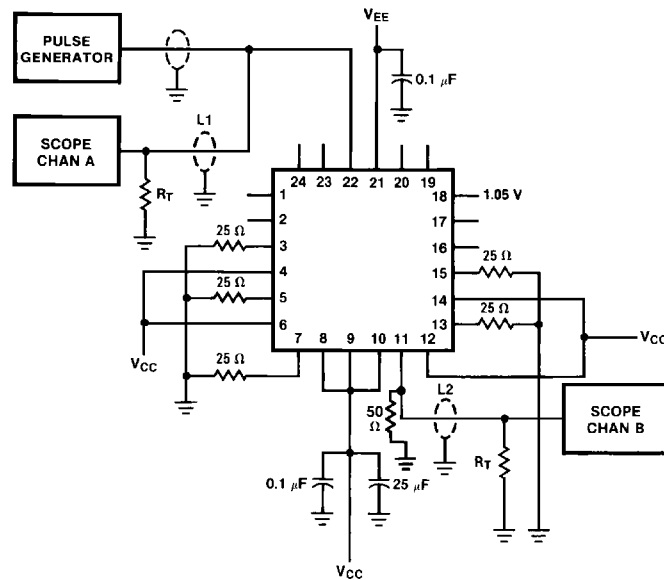

DS00877-5

Notes:

V_{CC} , $V_{CCA} = +2V$, $V_{EE} = -2.5V$

$L1$ and $L2$ = equal length 50Ω impedance lines

R_T = 50Ω terminator internal to scope

Decoupling $0.1 \mu F$ from GND to V_{CC} and V_{EE}

All unused outputs are loaded with 25Ω to GND

C_L = Fixture and stray capacitance $\leq 3 pF$

Pin numbers shown are for flatpak; for DIP see logic symbol

FIGURE 1. AC Test Circuit

Timing Waveform

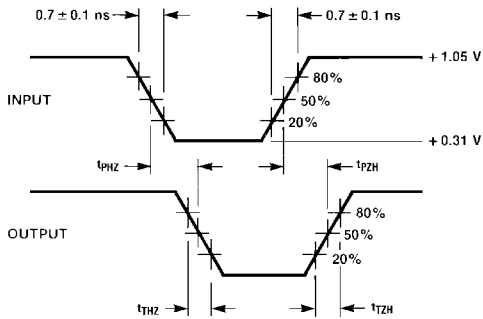

DS009877-6

FIGURE 2. Propagation Delay and Transition Times

Ordering Information

The device number is used to form part of a simplified purchasing code where a package type and temperature range are defined as follows:

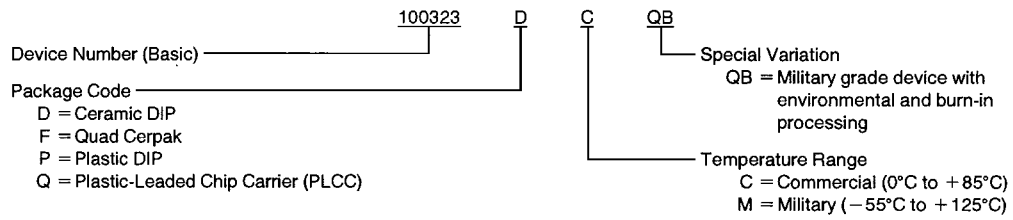

DS009877-8

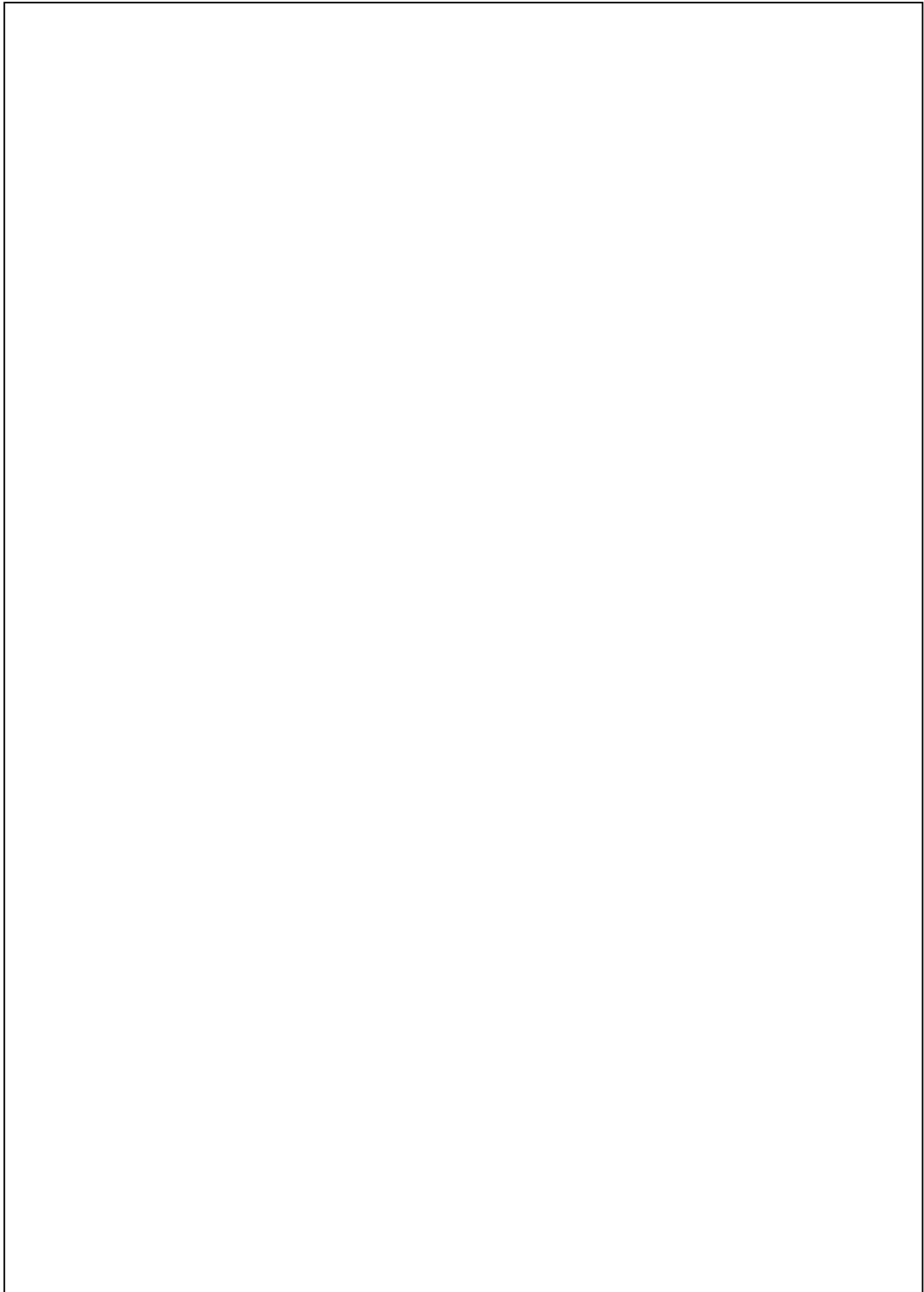

Physical Dimensions inches (millimeters) unless otherwise noted

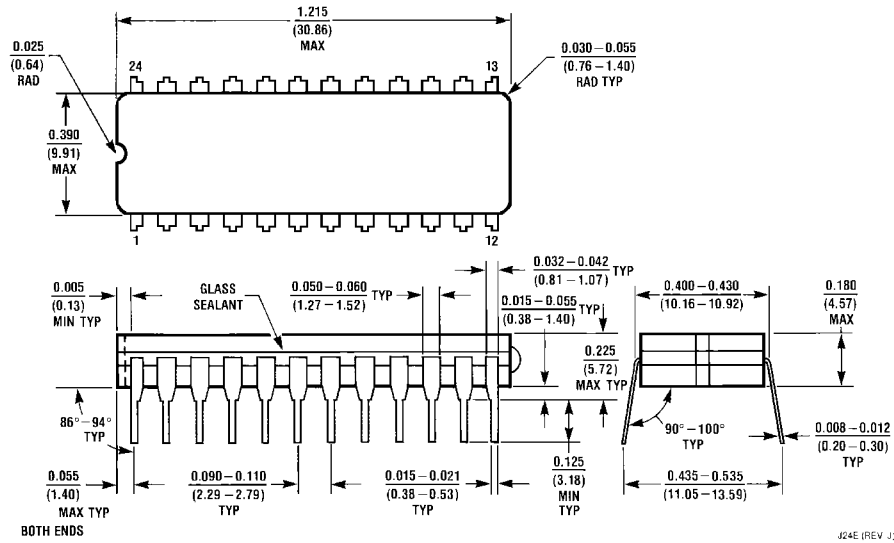

J24E (REV J)

24 Lead Ceramic Dual-In-Line Package (0.400" Wide) (D)
Package Number J24E

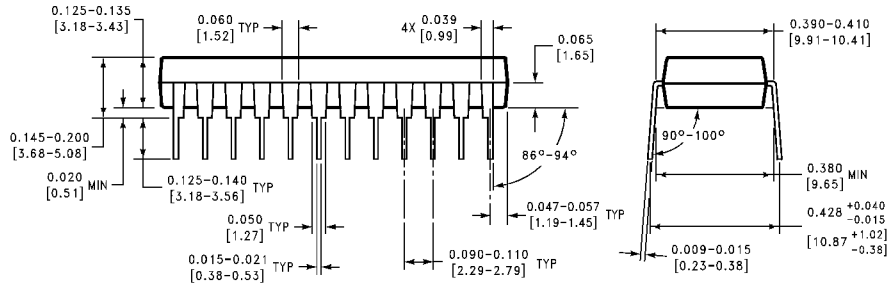
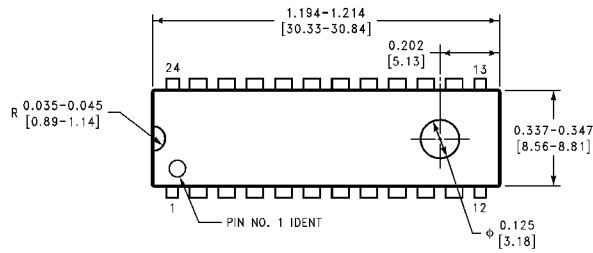

N24E (REV A)

24 Lead Plastic Dual-In-Line Package (P)
Package Number N24E

Physical Dimensions inches (millimeters) unless otherwise noted (Continued)

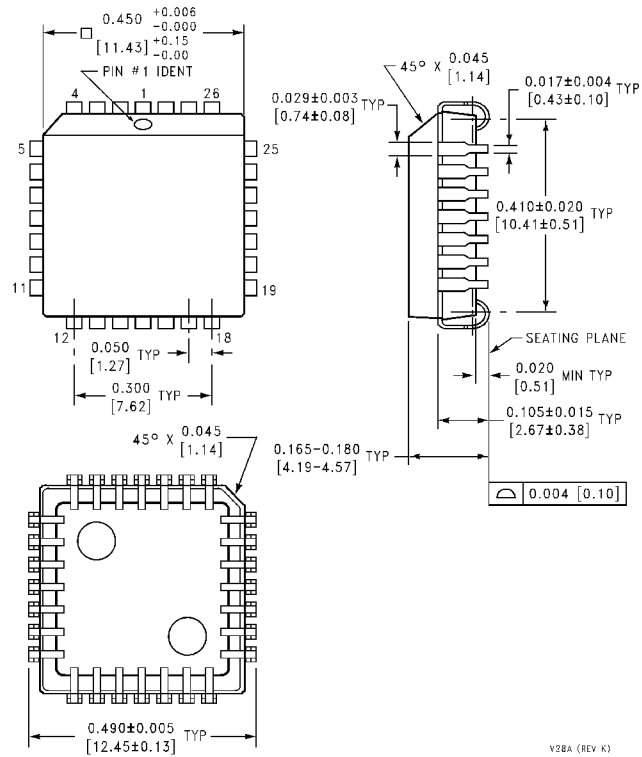

**28 Lead Plastic Chip Carrier (Q)
Package Number V28A**

V28A (REV K)

Physical Dimensions inches (millimeters) unless otherwise noted (Continued)

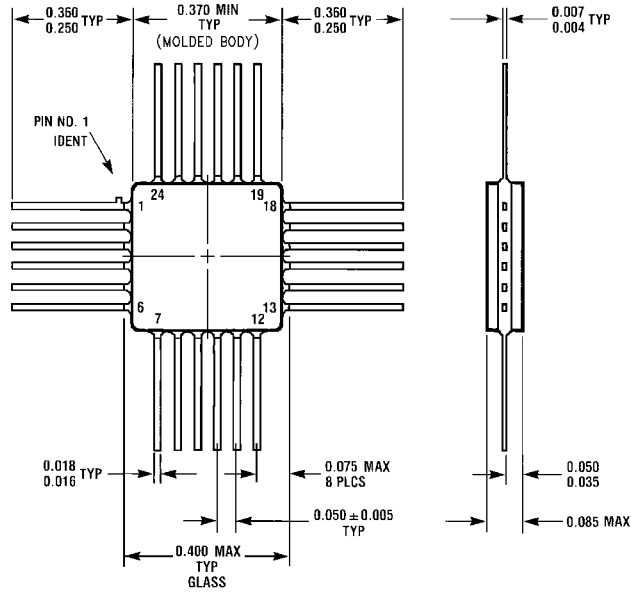

W24B (REV D)

**24 Lead Quad Cerpak (F)
Package Number W24B**

LIFE SUPPORT POLICY

FAIRCHILD'S PRODUCTS ARE NOT AUTHORIZED FOR USE AS CRITICAL COMPONENTS IN LIFE SUPPORT DEVICES OR SYSTEMS WITHOUT THE EXPRESS WRITTEN APPROVAL OF THE PRESIDENT OF FAIRCHILD SEMICONDUCTOR CORPORATION. As used herein:

1. Life support devices or systems are devices or systems which, (a) are intended for surgical implant into the body, or (b) support or sustain life, and (c) whose failure to perform when properly used in accordance with instructions for use provided in the labeling, can be reasonably expected to result in a significant injury to the user.
2. A critical component in any component of a life support device or system whose failure to perform can be reasonably expected to cause the failure of the life support device or system, or to affect its safety or effectiveness.

Fairchild Semiconductor Corporation
Americas
Customer Response Center
Tel: 1-888-522-5372

Fairchild Semiconductor Europe
Fax: +49 (0) 1 80-530 85 86
Email: europe.support@nsc.com
Deutsch Tel: +49 (0) 8 141-35-0
English Tel: +44 (0) 1 793-85-68-56
Italy Tel: +39 (0) 2 57 5631

Fairchild Semiconductor Hong Kong Ltd.
13th Floor, Straight Block,
Ocean Centre, 5 Canton Rd.
Tsimshatsui, Kowloon
Hong Kong
Tel: +852 2737-7200
Fax: +852 2314-0061

National Semiconductor Japan Ltd.
Tel: 81-3-5620-6175
Fax: 81-3-5620-6179

www.fairchildsemi.com