

SN54ALS136, SN54AS136, SN74ALS136, SN74AS136 QUADRUPLE 2-INPUT EXCLUSIVE-OR GATES WITH OPEN-COLLECTOR OUTPUTS

SDAS162 – MARCH 1984–REVISED OCTOBER 1988

- Package Options include Plastic “Small Outline” Packages, Ceramic Chip Carriers, and Standard Plastic and Ceramic 300-mil DIPs
- Dependable Texas Instruments Quality and Reliability

description

These devices contain four independent Exclusive-OR gates with open-collector outputs. They perform the Boolean functions $Y = A \oplus B = \bar{A}B + A\bar{B}$ in positive logic.

A common application is a true/complement element. If one of the inputs is low, the other input will be reproduced in true form at the output. If one of the inputs is high, the signal on the other input will be reproduced inverted at the output.

The SN54ALS136 and SN54AS136 are characterized for operation over the full military temperature range of -55°C to 125°C . The SN74ALS136 and SN74AS136 are characterized for operation from 0°C to 70°C .

logic symbol†

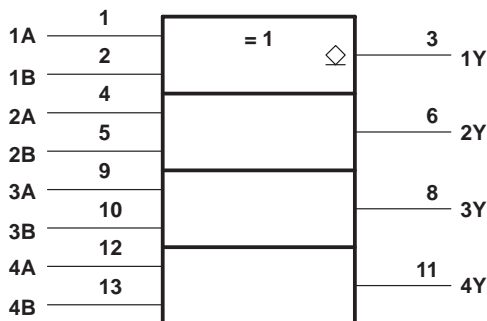

† This symbol is in accordance with ANSI/IEEE Std 91-1984 and IEC Publication 617-12.

Pin numbers shown are for D, J, and N packages.

SN54ALS136, SN54AS136 . . . J PACKAGE
SN74ALS136, SN74AS136 . . . D OR N PACKAGE
(TOP VIEW)

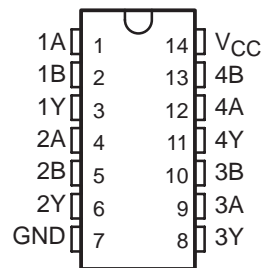

SN54ALS136, SN54AS136 . . . FK PACKAGE
(TOP VIEW)

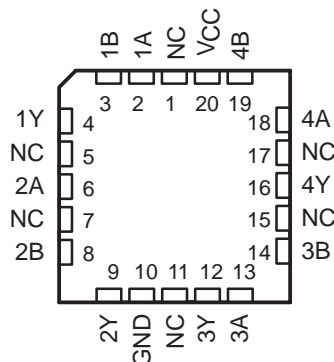

NC – No internal connection

FUNCTION TABLE
(each gate)

INPUTS		OUTPUT
A	B	Y
L	L	L
L	H	H
H	L	H
H	H	L

SN54ALS136, SN54AS136, SN74ALS136, SN74AS136 QUADRUPLE 2-INPUT EXCLUSIVE-OR GATES WITH OPEN-COLLECTOR OUTPUTS

SDAS162 – MARCH 1984–REVISED OCTOBER 1988

exclusive-OR logic

An Exclusive-OR gate has many applications, some of which can be represented better by alternative logic symbols.

EXCLUSIVE-OR

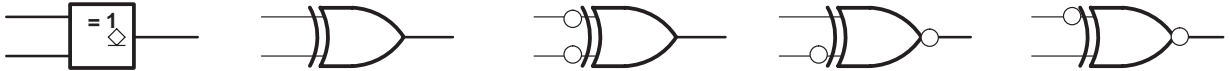

These are five equivalent Exclusive-OR symbols valid for an 'ALS136 gate in positive logic; negation may be shown at any two ports.

LOGIC IDENTITY ELEMENT

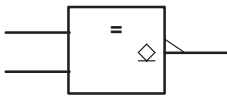

The output is active (low) if all inputs stand at the same logic level (i.e., $A=B$).

EVEN-PARITY

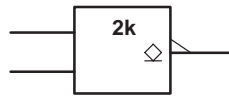

The output is active (low) if an even number of inputs (i.e., 0 or 2) are active.

ODD-PARITY ELEMENT

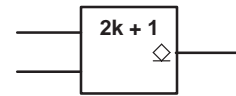

The output is active (high if an odd number of inputs (i.e., only 1 of the 2) are active).

SN54ALS136, SN74ALS136 QUADRUPLE 2-INPUT EXCLUSIVE-OR GATES WITH OPEN-COLLECTOR OUTPUTS

SDAS162 – MARCH 1984–REVISED OCTOBER 1988

absolute maximum ratings over operating free-air temperature range (unless otherwise noted)

Supply voltage, V_{CC}	7 V
Input voltage	7 V
Off-state output voltage	7 V
Operating free-air temperature range: SN54ALS136	–55°C to 125°C
SN74ALS136	0°C to 70°C
Storage temperature range	–65°C to 150°C

recommended operating conditions

	SN54ALS136			SN74ALS136			UNIT
	MIN	NOM	MAX	MIN	NOM	MAX	
V_{CC} Supply Voltage	4.5	5	5.5	4.5	5	5.5	V
V_{IH} High-level input Voltage	2			2			V
V_{IL} Low-level input voltage			0.7			0.8	V
V_{OH} High-level output current			5.5			5.5	V
I_{OL} Low-level output current			4			8	mA
T_A Operating free-air temperature	–55		125	0		70	°C

electrical characteristics over recommended operating free-air temperature range (unless otherwise noted)

PARAMETER	TEST CONDITIONS	SN54ALS136			SN74ALS136			UNIT
		MIN	TYP†	MAX	MIN	TYP†	MAX	
V_{IK}	$V_{CC} = 4.5\text{ V}$, $I_I = -18\text{ mA}$			–1.5			–1.5	V
I_{OH}	$V_{CC} = 4.5\text{ V}$, $V_{OH} = 5.5\text{ V}$			0.1			0.1	mA
V_{OL}	$V_{CC} = 4.5\text{ V}$, $I_{OL} = 4\text{ mA}$		0.25	0.4		0.25	0.4	V
	$V_{CC} = 4.5\text{ V}$, $I_{OL} = 8\text{ mA}$					0.35	0.5	
I_I	$V_{CC} = 5.5\text{ V}$, $V_I = 7\text{ V}$			0.1			0.1	mA
I_{IH}	$V_{CC} = 5.5\text{ V}$, $V_I = 2.7\text{ V}$			20			20	μA
I_{IL}	$V_{CC} = 5.5\text{ V}$, $V_I = 0.4\text{ V}$			–0.1			–0.1	mA
I_{CC}	$V_{CC} = 5.5\text{ V}$ All inputs at 4.5 V		3.9	5.9		3.9	5.9	mA

† All typical values are at $V_{CC} = 5$, $T_A = 25^\circ\text{C}$.

switching characteristics (see Note 1)

PARAMETER	FROM (INPUT)	TO (OUTPUT)	$V_{CC} = 4.5\text{ V to }5.5\text{ V}$, $C_L = 50\text{ pF}$, $R_L = 2\text{ k}\Omega$, $T_A = \text{MIN to MAX}$				UNIT
			SN54ALS136		SN74ALS136		
			MIN	MAX	MIN	MAX	
t_{PLH}	A or B	Y	20	55	20	50	ns
t_{PHL}	(other input low)		3	18	3	15	
t_{PLH}	A or B	Y	20	55	20	50	ns
t_{PHL}	(other input low)		3	18	3	15	

NOTE 1: Load circuit and voltage waveforms are shown in Section 1 of the ALS/AS Logic Data Book, 1986.



SN54AS136, SN74AS136 QUADRUPLE 2-INPUT EXCLUSIVE-OR GATES WITH OPEN-COLLECTOR OUTPUTS

SDAS162 – MARCH 1984–REVISED OCTOBER 1988

absolute maximum ratings over operating free-air temperature range (unless otherwise noted)

Supply voltage, V_{CC}	7 V
Input voltage	7 V
Off-state output voltage	7 V
Operating free-air temperature range: SN54AS136	-55°C to 125°C
SN74AS136	0°C to 70°C
Storage temperature range	65°C to 150°C

recommended operating conditions

	SN54AS136			SN74ALS136			UNIT
	MIN	NOM	MAX	MIN	NOM	MAX	
V_{CC} Supply Voltage	4.5	5	5.5	4.5	5	5.5	V
V_{IH} High-level input Voltage	2			2			V
V_{IL} Low-level input voltage			0.8			0.8	V
V_{OH} High-level output current			5.5			5.5	V
I_{OL} Low-level output current			20			20	mA
T_A Operating free-air temperature	-55		125	0		70	°C

electrical characteristics over recommended operating free-air temperature range (unless otherwise noted)

PARAMETER	TEST CONDITIONS	SN54AS136			SN74AS136			UNIT
		MIN	TYP†	MAX	MIN	TYP†	MAX	
V_{IK}	$V_{CC} = 4.5 V$, $I_I = -18 mA$			-1.5			-1.5	V
I_{OH}	$V_{CC} = 4.5 V$, $V_{OH} = 5.5 V$			2			0.1	mA
V_{OL}	$V_{CC} = 4.5 V$, $I_{OL} = 4 mA$		0.35	0.5		0.25	0.4	V
I_I	$V_{CC} = 5.5 V$, $V_I = 7 V$			0.1			0.1	mA
I_{IH}	$V_{CC} = 5.5 V$, $V_I = 2.7 V$			20			20	μA
I_{IL}	$V_{CC} = 5.5 V$, $V_I = 0.4 V$			-0.5			-0.5	mA
I_{CC}	$V_{CC} = 5.5 V$, $V_{IA} = 4.5 V$, $V_{IB} = 0$		14	20		14	20	mA
I_{CCL}	$V_{CC} = 5.5 V$, $V_{IA} = 4.5 V$		22	31		22	31	mA

† All typical values are at $V_{CC} = 5$, $T_A = 25^\circ C$.

switching characteristics (see Note 1)

PARAMETER	FROM (INPUT)	TO (OUTPUT)	$V_{CC} = 4.5 V$ to $5.5 V$, $C_L = 50 pF$, $R_L = 2 k\Omega$, $T_A = MIN$ to MAX				UNIT
			SN54AS136		SN74ALS136		
			MIN	MAX	MIN	MAX	
t_{PLH}	A or B	Y	6.3	14.8	6.3	12.5	ns
t_{PHL}	(other input low)		3.3	7.9	3.3	7.1	
t_{PLH}	A or B	Y	6.3	12.4	6.3	11.4	ns
t_{PHL}	(other input low)		3.3	14.1	3.3	10.7	

NOTE 1: Load circuit and voltage waveforms are shown in Section 1 of the ALS/AS Logic Data Book, 1986.



IMPORTANT NOTICE

Texas Instruments Incorporated and its subsidiaries (TI) reserve the right to make corrections, modifications, enhancements, improvements, and other changes to its products and services at any time and to discontinue any product or service without notice. Customers should obtain the latest relevant information before placing orders and should verify that such information is current and complete. All products are sold subject to TI's terms and conditions of sale supplied at the time of order acknowledgment.

TI warrants performance of its hardware products to the specifications applicable at the time of sale in accordance with TI's standard warranty. Testing and other quality control techniques are used to the extent TI deems necessary to support this warranty. Except where mandated by government requirements, testing of all parameters of each product is not necessarily performed.

TI assumes no liability for applications assistance or customer product design. Customers are responsible for their products and applications using TI components. To minimize the risks associated with customer products and applications, customers should provide adequate design and operating safeguards.

TI does not warrant or represent that any license, either express or implied, is granted under any TI patent right, copyright, mask work right, or other TI intellectual property right relating to any combination, machine, or process in which TI products or services are used. Information published by TI regarding third-party products or services does not constitute a license from TI to use such products or services or a warranty or endorsement thereof. Use of such information may require a license from a third party under the patents or other intellectual property of the third party, or a license from TI under the patents or other intellectual property of TI.

Reproduction of TI information in TI data books or data sheets is permissible only if reproduction is without alteration and is accompanied by all associated warranties, conditions, limitations, and notices. Reproduction of this information with alteration is an unfair and deceptive business practice. TI is not responsible or liable for such altered documentation. Information of third parties may be subject to additional restrictions.

Resale of TI products or services with statements different from or beyond the parameters stated by TI for that product or service voids all express and any implied warranties for the associated TI product or service and is an unfair and deceptive business practice. TI is not responsible or liable for any such statements.

TI products are not authorized for use in safety-critical applications (such as life support) where a failure of the TI product would reasonably be expected to cause severe personal injury or death, unless officers of the parties have executed an agreement specifically governing such use. Buyers represent that they have all necessary expertise in the safety and regulatory ramifications of their applications, and acknowledge and agree that they are solely responsible for all legal, regulatory and safety-related requirements concerning their products and any use of TI products in such safety-critical applications, notwithstanding any applications-related information or support that may be provided by TI. Further, Buyers must fully indemnify TI and its representatives against any damages arising out of the use of TI products in such safety-critical applications.

TI products are neither designed nor intended for use in military/aerospace applications or environments unless the TI products are specifically designated by TI as military-grade or "enhanced plastic." Only products designated by TI as military-grade meet military specifications. Buyers acknowledge and agree that any such use of TI products which TI has not designated as military-grade is solely at the Buyer's risk, and that they are solely responsible for compliance with all legal and regulatory requirements in connection with such use.

TI products are neither designed nor intended for use in automotive applications or environments unless the specific TI products are designated by TI as compliant with ISO/TS 16949 requirements. Buyers acknowledge and agree that, if they use any non-designated products in automotive applications, TI will not be responsible for any failure to meet such requirements.

Following are URLs where you can obtain information on other Texas Instruments products and application solutions:

Products

Amplifiers	amplifier.ti.com
Data Converters	dataconverter.ti.com
DSP	dsp.ti.com
Clocks and Timers	www.ti.com/clocks
Interface	interface.ti.com
Logic	logic.ti.com
Power Mgmt	power.ti.com
Microcontrollers	microcontroller.ti.com
RFID	www.ti-rfid.com
RF/IF and ZigBee® Solutions	www.ti.com/lprf

Applications

Audio	www.ti.com/audio
Automotive	www.ti.com/automotive
Broadband	www.ti.com/broadband
Digital Control	www.ti.com/digitalcontrol
Medical	www.ti.com/medical
Military	www.ti.com/military
Optical Networking	www.ti.com/opticalnetwork
Security	www.ti.com/security
Telephony	www.ti.com/telephony
Video & Imaging	www.ti.com/video
Wireless	www.ti.com/wireless

Mailing Address: Texas Instruments, Post Office Box 655303, Dallas, Texas 75265
Copyright © 2008, Texas Instruments Incorporated