

MC74AC74, MC74ACT74

Dual D-Type Positive Edge-Triggered Flip-Flop

The MC74AC74/74ACT74 is a dual D-type flip-flop with Asynchronous Clear and Set inputs and complementary (Q, \bar{Q}) outputs. Information at the input is transferred to the outputs on the positive edge of the clock pulse. Clock triggering occurs at a voltage level of the clock pulse and is not directly related to the transition time of the positive-going pulse. After the Clock Pulse input threshold voltage has been passed, the Data input is locked out and information present will not be transferred to the outputs until the next rising edge of the Clock Pulse input.

Asynchronous Inputs:

- LOW input to \bar{S}_D (Set) sets Q to HIGH level
- LOW input to \bar{C}_D (Clear) sets Q to LOW level
- Clear and Set are independent of clock
- Simultaneous LOW on \bar{C}_D and \bar{S}_D makes both Q and \bar{Q} HIGH

- Outputs Source/Sink 24 mA
- 'ACT74 Has TTL Compatible Inputs
- These devices are available in Pb-free package(s). Specifications herein apply to both standard and Pb-free devices. Please see our website at www.onsemi.com for specific Pb-free orderable part numbers, or contact your local ON Semiconductor sales office or representative.

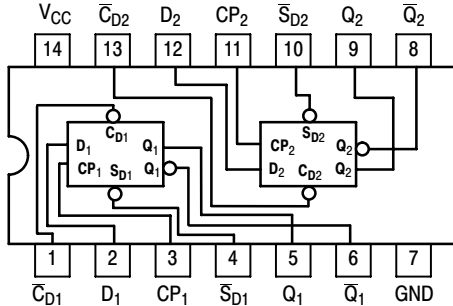

Figure 1. Pinout: 14-Lead Packages Conductors (Top View)

PIN ASSIGNMENT

PIN	FUNCTION
D_1, D_2	Data Inputs
CP_1, CP_2	Clock Pulse Inputs
$\bar{C}_{D1}, \bar{C}_{D2}$	Direct Clear Inputs
$\bar{S}_{D1}, \bar{S}_{D2}$	Direct Set Inputs
$Q_1, \bar{Q}_1, Q_2, \bar{Q}_2$	Outputs



ON Semiconductor™

<http://onsemi.com>

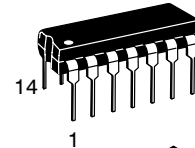

PDIP-14
N SUFFIX
CASE 646

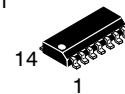

SO-14
D SUFFIX
CASE 751A

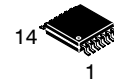

TSSOP-14
DT SUFFIX
CASE 948G

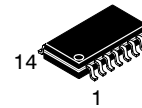

EIAJ-14
M SUFFIX
CASE 965

ORDERING INFORMATION



Device	Package	Shipping
MC74AC74N	PDIP-14	25 Units/Rail
MC74ACT74N	PDIP-14	25 Units/Rail
MC74AC74D	SOIC-14	55 Units/Rail
MC74AC74DR2	SOIC-14	2500 Tape & Reel
MC74ACT74D	SOIC-14	55 Units/Rail
MC74ACT74DR2	SOIC-14	2500 Tape & Reel
MC74AC74DT	TSSOP-14	96 Units/Rail
MC74AC74DTR2	TSSOP-14	2500 Tape & Reel
MC74ACT74DT	TSSOP-14	96 Units/Rail
MC74ACT74DTR2	TSSOP-14	2500 Tape & Reel
MC74AC74M	EIAJ-14	50 Units/Rail
MC74AC74MEL	EIAJ-14	2000 Tape & Reel
MC74ACT74M	EIAJ-14	50 Units/Rail
MC74ACT74MEL	EIAJ-14	2000 Tape & Reel

DEVICE MARKING INFORMATION

See general marking information in the device marking section on page 7 of this data sheet.

MC74AC74, MC74ACT74

TRUTH TABLE (Each Half)

Inputs				Outputs	
\bar{S}_D	\bar{C}_D	CP	D	Q	\bar{Q}
L	H	X	X	H	L
H	L	X	X	L	H
L	L	X	X	H	H
H	H		H	H	L
H	H		L	L	H
H	H	L	X	Q_0	\bar{Q}_0

NOTE: H = HIGH Voltage Level
 L = LOW Voltage Level
 X = Immaterial;
 = LOW-to-HIGH Clock Transition
 $Q_0(\bar{Q}_0)$ = Previous Q(\bar{Q}) before LOW-to-HIGH Transition of Clock

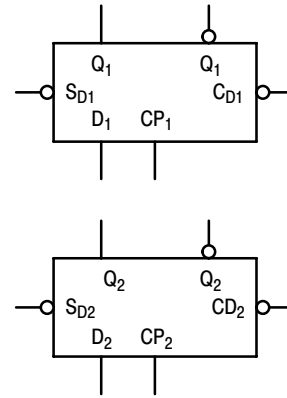
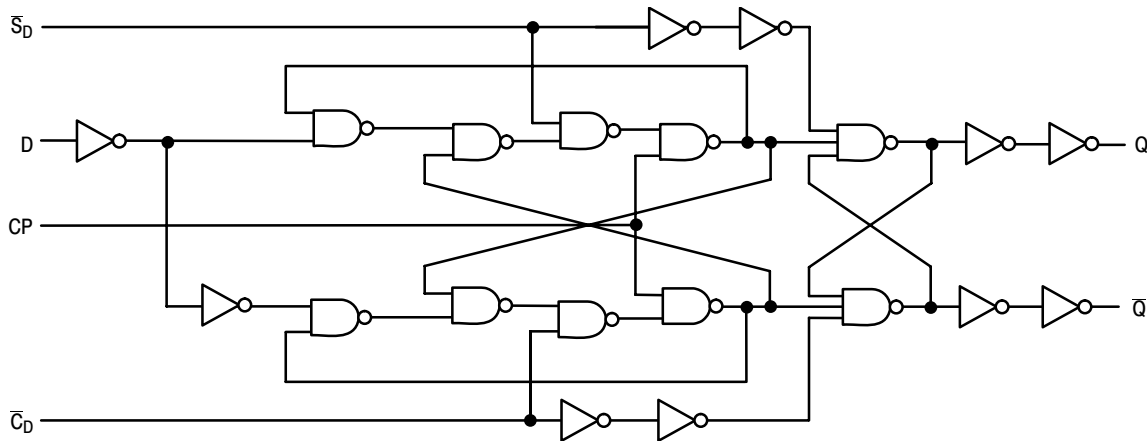

Figure 2. Logic Symbol



NOTE: This diagram is provided only for the understanding of logic operations and should not be used to estimate propagation delays.

Figure 3. Logic Diagram

MAXIMUM RATINGS*

Symbol	Parameter	Value	Unit
V_{CC}	DC Supply Voltage (Referenced to GND)	-0.5 to +7.0	V
V_{in}	DC Input Voltage (Referenced to GND)	-0.5 to $V_{CC} + 0.5$	V
V_{out}	DC Output Voltage (Referenced to GND)	-0.5 to $V_{CC} + 0.5$	V
I_{in}	DC Input Current, per Pin	± 20	mA
I_{out}	DC Output Sink/Source Current, per Pin	± 50	mA
I_{CC}	DC V_{CC} or GND Current per Output Pin	± 50	mA
T_{stg}	Storage Temperature	-65 to +150	$^{\circ}C$

*Maximum Ratings are those values beyond which damage to the device may occur. Functional operation should be restricted to the Recommended Operating Conditions.

MC74AC74, MC74ACT74

RECOMMENDED OPERATING CONDITIONS

Symbol	Parameter	Min	Typ	Max	Unit	
V _{CC}	Supply Voltage	'AC	2.0	5.0	6.0	V
		'ACT	4.5	5.0	5.5	
V _{in} , V _{out}	DC Input Voltage, Output Voltage (Ref. to GND)	0	–	V _{CC}	V	
t _r , t _f	Input Rise and Fall Time (Note) 'AC Devices except Schmitt Inputs	V _{CC} @ 3.0 V	–	150	–	ns/V
		V _{CC} @ 4.5 V	–	40	–	
		V _{CC} @ 5.5 V	–	25	–	
t _r , t _f	Input Rise and Fall Time (Note) 'ACT Devices except Schmitt Inputs	V _{CC} @ 4.5 V	–	10	–	ns/V
		V _{CC} @ 5.5 V	–	8.0	–	
T _J	Junction Temperature (PDIP)	–	–	140	°C	
T _A	Operating Ambient Temperature Range	–40	25	85	°C	
I _{OH}	Output Current – High	–	–	–24	mA	
I _{OL}	Output Current – Low	–	–	24	mA	

- V_{in} from 30% to 70% V_{CC}; see individual Data Sheets for devices that differ from the typical input rise and fall times.
- V_{in} from 0.8 V to 2.0 V; see individual Data Sheets for devices that differ from the typical input rise and fall times.

DC CHARACTERISTICS

Symbol	Parameter	V _{CC} (V)	74AC		74ACT	Unit	Conditions			
			T _A = +25°C		T _A = –40°C to +85°C					
			Typ	Guaranteed Limits						
V _{IH}	Minimum High Level Input Voltage	3.0	1.5	2.1	2.1	V	V _{OUT} = 0.1 V or V _{CC} – 0.1 V			
		4.5	2.25	3.15	3.15					
		5.5	2.75	3.85	3.85					
V _{IL}	Maximum Low Level Input Voltage	3.0	1.5	0.9	0.9	V	V _{OUT} = 0.1 V or V _{CC} – 0.1 V			
		4.5	2.25	1.35	1.35					
		5.5	2.75	1.65	1.65					
V _{OH}	Minimum High Level Output Voltage	3.0	2.99	2.9	2.9	V	I _{OUT} = –50 μA			
		4.5	4.49	4.4	4.4					
		5.5	5.49	5.4	5.4					
	3.0	–	2.56	2.46	V	*V _{IN} = V _{IL} or V _{IH} –12 mA I _{OH} –24 mA –24 mA				
							4.5	–	3.86	3.76
							5.5	–	4.86	4.76
V _{OL}	Maximum Low Level Output Voltage	3.0	0.002	0.1	0.1	V	I _{OUT} = 50 μA			
		4.5	0.001	0.1	0.1					
		5.5	0.001	0.1	0.1					
	3.0	–	0.36	0.44	V	*V _{IN} = V _{IL} or V _{IH} 12 mA I _{OL} 24 mA 24 mA				
							4.5	–	0.36	0.44
							5.5	–	0.36	0.44
I _{IN}	Maximum Input Leakage Current	5.5	–	±0.1	±1.0	μA	V _I = V _{CC} , GND			
I _{OLD}	†Minimum Dynamic Output Current	5.5	–	–	75	mA	V _{OLD} = 1.65 V Max			
I _{OHD}		5.5	–	–	–75	mA	V _{OHD} = 3.85 V Min			
I _{CC}	Maximum Quiescent Supply Current	5.5	–	4.0	40	μA	V _{IN} = V _{CC} or GND			

*All outputs loaded; thresholds on input associated with output under test.

†Maximum test duration 2.0 ms, one output loaded at a time.

NOTE: I_{IN} and I_{CC} @ 3.0 V are guaranteed to be less than or equal to the respective limit @ 5.5 V V_{CC}.

MC74AC74, MC74ACT74

AC CHARACTERISTICS (For Figures and Waveforms – See Section 3 of the ON Semiconductor FACT Data Book, DL138/D)

Symbol	Parameter	V _{CC} * (V)	74AC			74AC		Unit	Fig. No.
			T _A = +25°C C _L = 50 pF			T _A = -40°C to +85°C C _L = 50 pF			
			Min	Typ	Max	Min	Max		
f _{max}	Maximum Clock Frequency	3.3 5.0	100 140	125 160	– –	95 125	– –	MHz	3–3
t _{PLH}	Propagation Delay C _{Dn} or S _{Dn} to Q _n or Q _n	3.3 5.0	5.0 3.5	8.0 6.0	12.5 9.0	4.0 3.0	13.0 10.0	ns	3–6
t _{PHL}	Propagation Delay C _{Dn} or S _{Dn} to Q _n or Q _n	3.3 5.0	4.0 3.0	10.5 8.0	12.0 9.5	3.5 2.5	13.5 10.5	ns	3–6
t _{PLH}	Propagation Delay C _{Pn} to Q _n or Q _n	3.3 5.0	4.5 3.5	8.0 6.0	13.5 10.0	4.0 3.0	16.0 10.5	ns	3–6
t _{PHL}	Propagation Delay C _{Pn} to Q _n or Q _n	3.3 5.0	3.5 2.5	8.0 6.0	14.0 10.0	3.5 2.5	14.5 10.5	ns	3–6

*Voltage Range 3.3 V is 3.3 V ±0.3 V.
Voltage Range 5.0 V is 5.0 V ±0.5 V.

AC OPERATING REQUIREMENTS

Symbol	Parameter	V _{CC} * (V)	74AC		74AC		Unit	Fig. No.
			T _A = +25°C C _L = 50 pF		T _A = -40°C to +85°C C _L = 50 pF			
			Typ	Guaranteed Minimum				
t _s	Set-up Time, HIGH or LOW D _n to CP _n	3.3 5.0	1.5 1.0	4.0 3.0	4.5 3.0	ns	3–9	
t _h	Hold Time, HIGH or LOW D _n to CP _n	3.3 5.0	-2.0 -1.5	0.5 0.5	0.5 0.5	ns	3–9	
t _w	CP _n or C _{Dn} or S _{Dn} Pulse Width	3.3 5.0	3.0 2.5	5.5 4.5	7.0 5.0	ns	3–6	
t _{rec}	Recovery Time C _{Dn} or S _{Dn} to CP	3.3 5.0	-2.5 -2.0	0 0	0 0	ns	3–9	

*Voltage Range 3.3 V is 3.3 V ±0.3 V.
Voltage Range 5.0 V is 5.0 V ±0.5 V.

MC74AC74, MC74ACT74

DC CHARACTERISTICS

Symbol	Parameter	V _{CC} (V)	74ACT		74ACT		Unit	Conditions
			T _A = +25°C		T _A = -40°C to +85°C			
			Typ	Guaranteed Limits				
V _{IH}	Minimum High Level Input Voltage	4.5	1.5	2.0	2.0	V	V _{OUT} = 0.1 V or V _{CC} - 0.1 V	
		5.5	1.5	2.0	2.0			
V _{IL}	Maximum Low Level Input Voltage	4.5	1.5	0.8	0.8	V	V _{OUT} = 0.1 V or V _{CC} - 0.1 V	
		5.5	1.5	0.8	0.8			
V _{OH}	Minimum High Level Output Voltage	4.5	4.49	4.4	4.4	V	I _{OUT} = -50 μA	
		5.5	5.49	5.4	5.4			
		4.5	-	3.86	3.76	V	*V _{IN} = V _{IL} or V _{IH} I _{OH} = -24 mA	
		5.5	-	4.86	4.76			
V _{OL}	Maximum Low Level Output Voltage	4.5	0.001	0.1	0.1	V	I _{OUT} = 50 μA	
		5.5	0.001	0.1	0.1			
		4.5	-	0.36	0.44	V	*V _{IN} = V _{IL} or V _{IH} I _{OL} = 24 mA	
		5.5	-	0.36	0.44			
I _{IN}	Maximum Input Leakage Current	5.5	-	±0.1	±1.0	μA	V _I = V _{CC} , GND	
ΔI _{CC}	Additional Max. I _{CC} /Input	5.5	0.6	-	1.5	mA	V _I = V _{CC} - 2.1 V	
I _{OLD}	†Minimum Dynamic Output Current	5.5	-	-	75	mA	V _{OLD} = 1.65 V Max	
I _{OHD}		5.5	-	-	-75	mA	V _{OHD} = 3.85 V Min	
I _{CC}	Maximum Quiescent Supply Current	5.5	-	4.0	40	μA	V _{IN} = V _{CC} or GND	

*All outputs loaded; thresholds on input associated with output under test.

†Maximum test duration 2.0 ms, one output loaded at a time.

AC CHARACTERISTICS (For Figures and Waveforms – See Section 3 of the ON Semiconductor FACT Data Book, DL138/D)

Symbol	Parameter	V _{CC} * (V)	74ACT			74ACT		Unit	Fig. No.
			T _A = +25°C C _L = 50 pF			T _A = -40°C to +85°C C _L = 50 pF			
			Min	Typ	Max	Min	Max		
f _{max}	Maximum Clock Frequency	5.0	145	210	-	125	-	MHz	3-3
t _{PLH}	Propagation Delay C _{Dn} or S _{Dn} to Q _n or Q _n	5.0	3.0	5.5	9.5	2.5	10.5	ns	3-6
t _{PHL}	Propagation Delay C _{Dn} or S _{Dn} to Q _n or Q _n	5.0	3.0	6.0	10.0	3.0	11.5	ns	3-6
t _{PLH}	Propagation Delay C _{Pn} to Q _n or Q _n	5.0	4.0	7.5	11.0	4.0	13.0	ns	3-6
t _{PHL}	Propagation Delay C _{Pn} to Q _n or Q _n	5.0	3.5	6.0	10.0	3.0	11.5	ns	3-6

*Voltage Range 5.0 V is 5.0 V ±0.5 V.

MC74AC74, MC74ACT74

AC OPERATING REQUIREMENTS

Symbol	Parameter	V _{CC} * (V)	74ACT		74ACT	Unit	Fig. No.
			T _A = +25°C C _L = 50 pF		T _A = -40°C to +85°C C _L = 50 pF		
			Typ	Guaranteed Minimum			
t _s	Set-up Time, HIGH or LOW D _n to CP _n	5.0	1.0	3.0	3.5	ns	3-9
t _h	Hold Time, HIGH or LOW D _n to CP _n	5.0	-0.5	1.0	1.0	ns	3-9
t _w	C _{Pn} or C _{Dn} or S _{Dn} Pulse Width	5.0	3.0	5.0	6.0	ns	3-6
t _{rec}	Recovery Time C _{Dn} or S _{Dn} to CP	5.0	-2.5	0	0	ns	3-9

*Voltage Range 5.0 V is 5.0 V ±0.5 V.

CAPACITANCE

Symbol	Parameter	Value Typ	Unit	Test Conditions
C _{IN}	Input Capacitance	4.5	pF	V _{CC} = 5.0 V
C _{PD}	Power Dissipation Capacitance	35	pF	V _{CC} = 5.0 V

MC74AC74, MC74ACT74

MARKING DIAGRAMS

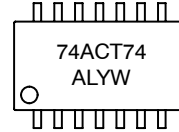
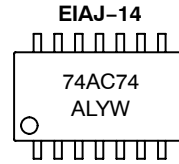
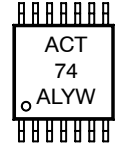
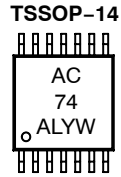
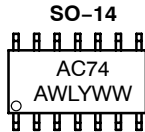
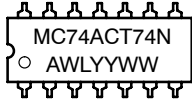
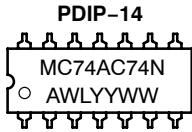

A = Assembly Location
WL, L = Wafer Lot
YY, Y = Year
WW, W = Work Week

MC74AC74, MC74ACT74

PACKAGE DIMENSIONS

PDIP-14
N SUFFIX
 14 PIN PLASTIC DIP PACKAGE
 CASE 646-06
 ISSUE M

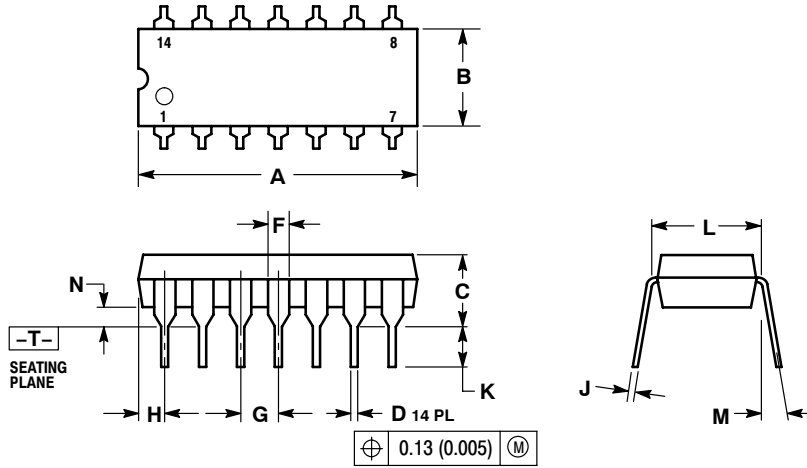

NOTES:

1. DIMENSIONING AND TOLERANCING PER ANSI Y14.5M, 1982.
2. CONTROLLING DIMENSION: INCH.
3. DIMENSION L TO CENTER OF LEADS WHEN FORMED PARALLEL.
4. DIMENSION B DOES NOT INCLUDE MOLD FLASH.
5. ROUNDED CORNERS OPTIONAL.

DIM	INCHES		MILLIMETERS	
	MIN	MAX	MIN	MAX
A	0.715	0.770	18.16	18.80
B	0.240	0.260	6.10	6.60
C	0.145	0.185	3.69	4.69
D	0.015	0.021	0.38	0.53
F	0.040	0.070	1.02	1.78
G	0.100 BSC		2.54 BSC	
H	0.052	0.095	1.32	2.41
J	0.008	0.015	0.20	0.38
K	0.115	0.135	2.92	3.43
L	0.290	0.310	7.37	7.87
M	---	10°	---	10°
N	0.015	0.039	0.38	1.01

SO-14
D SUFFIX
 14 PIN PLASTIC SOIC PACKAGE
 CASE 751A-03
 ISSUE F

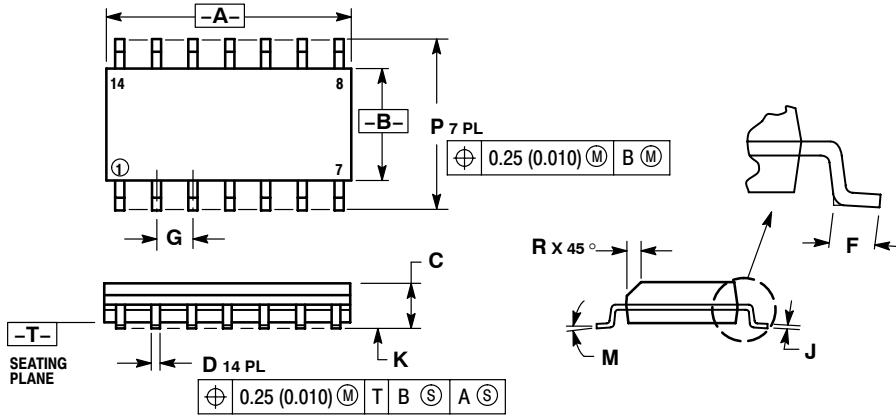

NOTES:

1. DIMENSIONING AND TOLERANCING PER ANSI Y14.5M, 1982.
2. CONTROLLING DIMENSION: MILLIMETER.
3. DIMENSIONS A AND B DO NOT INCLUDE MOLD PROTRUSION.
4. MAXIMUM MOLD PROTRUSION 0.15 (0.006) PER SIDE.
5. DIMENSION D DOES NOT INCLUDE DAMBAR PROTRUSION. ALLOWABLE DAMBAR PROTRUSION SHALL BE 0.127 (0.005) TOTAL IN EXCESS OF THE D DIMENSION AT MAXIMUM MATERIAL CONDITION.

DIM	MILLIMETERS		INCHES	
	MIN	MAX	MIN	MAX
A	8.55	8.75	0.337	0.344
B	3.80	4.00	0.150	0.157
C	1.35	1.75	0.054	0.068
D	0.35	0.49	0.014	0.019
F	0.40	1.25	0.016	0.049
G	1.27 BSC		0.050 BSC	
J	0.19	0.25	0.008	0.009
K	0.10	0.25	0.004	0.009
M	0°	7°	0°	7°
P	5.80	6.20	0.228	0.244
R	0.25	0.50	0.010	0.019

MC74AC74, MC74ACT74

PACKAGE DIMENSIONS

**TSSOP-14
DT SUFFIX**
14 PIN PLASTIC TSSOP PACKAGE
CASE 948G-01
ISSUE O

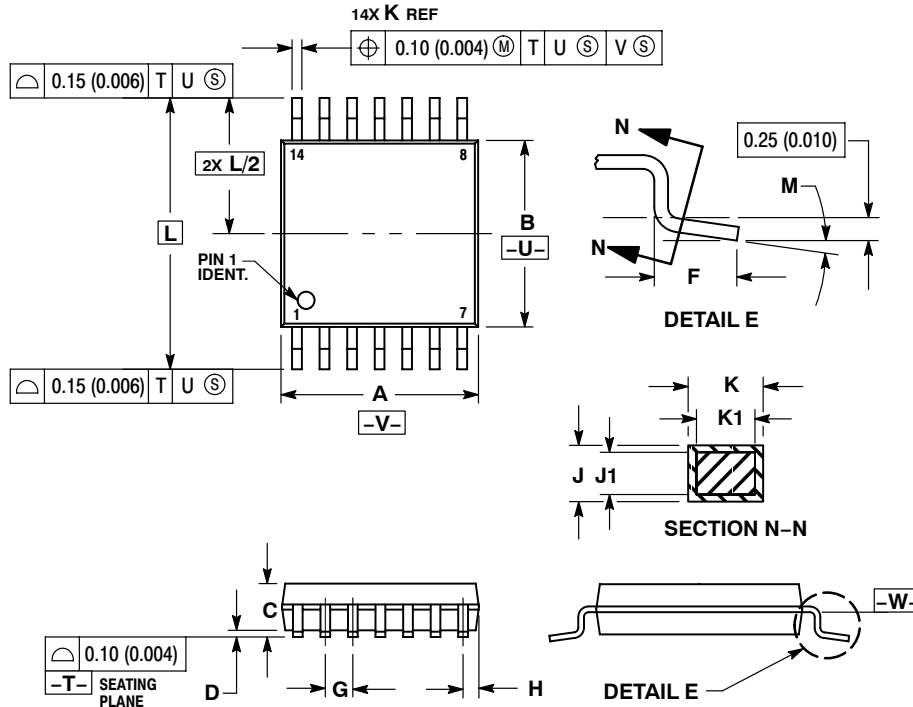

NOTES:

1. DIMENSIONING AND TOLERANCING PER ANSI Y14.5M, 1982.
2. CONTROLLING DIMENSION: MILLIMETER.
3. DIMENSION A DOES NOT INCLUDE MOLD FLASH, PROTRUSIONS OR GATE BURRS. MOLD FLASH OR GATE BURRS SHALL NOT EXCEED 0.15 (0.006) PER SIDE.
4. DIMENSION B DOES NOT INCLUDE INTERLEAD FLASH OR PROTRUSION. INTERLEAD FLASH OR PROTRUSION SHALL NOT EXCEED 0.25 (0.010) PER SIDE.
5. DIMENSION K DOES NOT INCLUDE DAMBAR PROTRUSION. ALLOWABLE DAMBAR PROTRUSION SHALL BE 0.08 (0.003) TOTAL IN EXCESS OF THE K DIMENSION AT MAXIMUM MATERIAL CONDITION.
6. TERMINAL NUMBERS ARE SHOWN FOR REFERENCE ONLY.
7. DIMENSION A AND B ARE TO BE DETERMINED AT DATUM PLANE -W-.

DIM	MILLIMETERS		INCHES	
	MIN	MAX	MIN	MAX
A	4.90	5.10	0.193	0.200
B	4.30	4.50	0.169	0.177
C	---	1.20	---	0.047
D	0.05	0.15	0.002	0.006
F	0.50	0.75	0.020	0.030
G	0.65 BSC		0.026 BSC	
H	0.50	0.60	0.020	0.024
J	0.09	0.20	0.004	0.008
J1	0.09	0.16	0.004	0.006
K	0.19	0.30	0.007	0.012
K1	0.19	0.25	0.007	0.010
L	6.40 BSC		0.252 BSC	
M	0°	8°	0°	8°

**EIAJ-14
M SUFFIX**
14 PIN PLASTIC EIAJ PACKAGE
CASE 965-01
ISSUE O

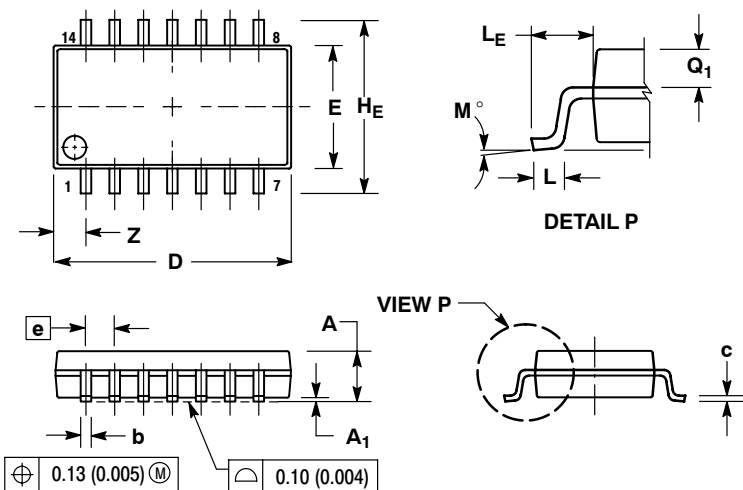

NOTES:

1. DIMENSIONING AND TOLERANCING PER ANSI Y14.5M, 1982.
2. CONTROLLING DIMENSION: MILLIMETER.
3. DIMENSIONS D AND E DO NOT INCLUDE MOLD FLASH OR PROTRUSIONS AND ARE MEASURED AT THE PARTING LINE. MOLD FLASH OR PROTRUSIONS SHALL NOT EXCEED 0.15 (0.006) PER SIDE.
4. TERMINAL NUMBERS ARE SHOWN FOR REFERENCE ONLY.
5. THE LEAD WIDTH DIMENSION (b) DOES NOT INCLUDE DAMBAR PROTRUSION. ALLOWABLE DAMBAR PROTRUSION SHALL BE 0.08 (0.003) TOTAL IN EXCESS OF THE LEAD WIDTH DIMENSION AT MAXIMUM MATERIAL CONDITION. DAMBAR CANNOT BE LOCATED ON THE LOWER RADIUS OR THE FOOT. MINIMUM SPACE BETWEEN PROTRUSIONS AND ADJACENT LEAD TO BE 0.46 (0.018).

DIM	MILLIMETERS		INCHES	
	MIN	MAX	MIN	MAX
A	---	2.05	---	0.081
A1	0.05	0.20	0.002	0.008
b	0.35	0.50	0.014	0.020
c	0.18	0.27	0.007	0.011
D	9.90	10.50	0.390	0.413
E	5.10	5.45	0.201	0.215
e	1.27 BSC		0.050 BSC	
HE	7.40	8.20	0.291	0.323
0.50	0.50	0.85	0.020	0.033
LE	1.10	1.50	0.043	0.059
M	0°	10°	0°	10°
Q1	0.70	0.90	0.028	0.035
Z	---	1.42	---	0.056

Notes

Notes

ON Semiconductor and  are registered trademarks of Semiconductor Components Industries, LLC (SCILLC). SCILLC reserves the right to make changes without further notice to any products herein. SCILLC makes no warranty, representation or guarantee regarding the suitability of its products for any particular purpose, nor does SCILLC assume any liability arising out of the application or use of any product or circuit, and specifically disclaims any and all liability, including without limitation special, consequential or incidental damages. "Typical" parameters which may be provided in SCILLC data sheets and/or specifications can and do vary in different applications and actual performance may vary over time. All operating parameters, including "Typicals" must be validated for each customer application by customer's technical experts. SCILLC does not convey any license under its patent rights nor the rights of others. SCILLC products are not designed, intended, or authorized for use as components in systems intended for surgical implant into the body, or other applications intended to support or sustain life, or for any other application in which the failure of the SCILLC product could create a situation where personal injury or death may occur. Should Buyer purchase or use SCILLC products for any such unintended or unauthorized application, Buyer shall indemnify and hold SCILLC and its officers, employees, subsidiaries, affiliates, and distributors harmless against all claims, costs, damages, and expenses, and reasonable attorney fees arising out of, directly or indirectly, any claim of personal injury or death associated with such unintended or unauthorized use, even if such claim alleges that SCILLC was negligent regarding the design or manufacture of the part. SCILLC is an Equal Opportunity/Affirmative Action Employer. This literature is subject to all applicable copyright laws and is not for resale in any manner.

PUBLICATION ORDERING INFORMATION

LITERATURE FULFILLMENT:

Literature Distribution Center for ON Semiconductor
P.O. Box 61312, Phoenix, Arizona 85082-1312 USA

Phone: 480-829-7710 or 800-344-3860 Toll Free USA/Canada

Fax: 480-829-7709 or 800-344-3867 Toll Free USA/Canada

Email: orderlit@onsemi.com

N. American Technical Support: 800-282-9855 Toll Free
USA/Canada

Japan: ON Semiconductor, Japan Customer Focus Center
2-9-1 Kamimeguro, Meguro-ku, Tokyo, Japan 153-0051
Phone: 81-3-5773-3850

ON Semiconductor Website: <http://onsemi.com>

Order Literature: <http://www.onsemi.com/litorder>

For additional information, please contact your
local Sales Representative.