

HARRIS
CA3049 OBSOLETE PRODUCT
NO RECOMMENDED REPLACEMENT
 Call Central Applications 1-800-442-7747
 or email: centapp@harris.com

CA3049, CA3102

Dual High Frequency Differential Amplifiers For Low Power Applications Up to 500MHz

December 1998

Features

- Power Gain 23dB (Typ) 200MHz
- Noise Figure 4.6dB (Typ)..... 200MHz
- Two Differential Amplifiers on a Common Substrate
- Independently Accessible Inputs and Outputs
- Full Military Temperature Range -55°C to 125°C

Applications

- VHF Amplifiers
- VHF Mixers
- Multifunction Combinations - RF/Mixer/Oscillator; Converter/IF
- IF Amplifiers (Differential and/or Cascode)
- Product Detectors
- Doubly Balanced Modulators and Demodulators
- Balanced Quadrature Detectors
- Cascade Limiters
- Synchronous Detectors
- Balanced Mixers
- Synthesizers
- Balanced (Push-Pull) Cascode Amplifiers
- Sense Amplifiers

Description

The CA3049T and CA3102 consist of two independent differential amplifiers with associated constant current transistors on a common monolithic substrate. The six transistors which comprise the amplifiers are general purpose devices which exhibit low 1/f noise and a value of f_T in excess of 1GHz. These feature make the CA3049T and CA3102 useful from DC to 500MHz. Bias and load resistors have been omitted to provide maximum application flexibility.

The monolithic construction of the CA3049T and CA3102 provides close electrical and thermal matching of the amplifiers. This feature makes these devices particularly useful in dual channel applications where matched performance of the two channels is required.

The CA3102 is like the CA3049T except that it has a separate substrate connection for greater design flexibility.

Formerly Developmental Type No. TA6228.

Ordering Information

PART NUMBER (BRAND)	TEMP. RANGE (°C)	PACKAGE	PKG. NO.
CA3049T	-55 to 125	12 Pin Metal Can	T12.B
CA3102E	-55 to 125	14 Ld PDIP	E14.3
CA3102M (3102)	-55 to 125	14 Ld SOIC	M14.15
CA3102M96 (3102)	-55 to 125	14 Ld SOIC Tape and Reel	M14.15

Pinouts

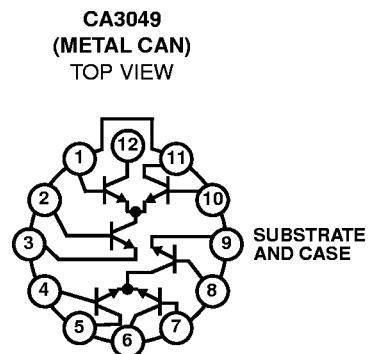
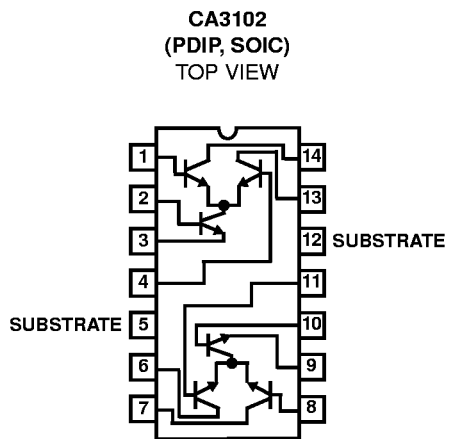

CAUTION: These devices are sensitive to electrostatic discharge. Users should follow proper IC Handling Procedures.

CA3049, CA3102

Absolute Maximum Ratings

Collector-to-Emitter Voltage, V_{CEO}	15V
Collector-to-Base Voltage, V_{CBO}	20V
Collector-to-Substrate Voltage, V_{CIO} (Note 1)	20V
Emitter-to-Base Voltage, V_{EBO}	5V
Collector Current, I_C	50mA

Operating Conditions

Temperature Range	-55°C to 125°C
-------------------------	----------------

Thermal Information

Thermal Resistance (Typical, Note 2)	θ_{JA} (°C/W)
Metal Can Package	225
PDIP Package	130
SOIC Package	140
Maximum Power Dissipation (Any One Transistor)	300mW
Maximum Junction Temperature (Can Package)	175°C
Maximum Junction Temperature (Plastic Package)	150°C
Maximum Storage Temperature Range	-65°C to 150°C
Maximum Lead Temperature (Soldering 10s)	300°C
(SOIC - Lead Tips Only)	

CAUTION: Stresses above those listed in "Absolute Maximum Ratings" may cause permanent damage to the device. This is a stress only rating and operation of the device at these or any other conditions above those indicated in the operational sections of this specification is not implied.

NOTES:

- The collector of each transistor of the CA3049T and CA3102 is isolated from the substrate by an integral diode. The substrate (Terminal 9) must be connected to the most negative point in the external circuit to maintain isolation between transistors and to provide for normal transistor action.
- θ_{JA} is measured with the component mounted on an evaluation PC board in free air.

Electrical Specifications $T_A = 25^\circ\text{C}$

PARAMETER	SYMBOL	TEST CONDITIONS	CA3102			CA3049			UNIT	
			MIN	TYP	MAX	MIN	TYP	MAX		
DC CHARACTERISTICS FOR EACH DIFFERENTIAL AMPLIFIER										
Input Offset Voltage (Figures 1, 4)	V_{IO}		-	0.25	5.0	-	0.25	-	mV	
Input Offset Current (Figure 1)	I_{IO}	$I_3 = I_9 = 2\text{mA}$	-	0.3	3.0	-	0.3	-	μA	
Input Bias Current (Figures 1, 5)	I_B		-	13.5	33	-	13.5	33	μA	
Temperature Coefficient Magnitude of Input Offset Voltage	$\frac{ \Delta V_{IO} }{\Delta T}$		-	1.1	-	-	1.1	-	$\mu\text{V}/^\circ\text{C}$	
DC CHARACTERISTICS FOR EACH TRANSISTOR										
DC Forward Base-to-Emitter Voltage (Figure 6)	V_{BE}	$V_{CE} = 6\text{V}, I_C = 1\text{mA}$	674	774	874	-	774	-	mV	
Temperature Coefficient of Base-to-Emitter Voltage (Figure 6)	$\frac{\Delta V_{BE}}{\Delta T}$	$V_{CE} = 6\text{V}, I_C = 1\text{mA}$	-	-0.9	-	-	-0.9	-	$\text{mV}/^\circ\text{C}$	
Collector Cutoff Current (Figure 7)	I_{CBO}	$V_{CB} = 10\text{V}, I_E = 0$	-	0.0013	100	-	0.0013	100	nA	
Collector-to-Emitter Breakdown Voltage	$V_{(BR)CEO}$	$I_C = 1\text{mA}, I_B = 0$	15	24	-	15	24	-	V	
Collector-to-Base Breakdown Voltage	$V_{(BR)CBO}$	$I_C = 10\mu\text{A}, I_E = 0$	20	60	-	20	60	-	V	
Collector-to-Substrate Breakdown Voltage	$V_{(BR)CIO}$	$I_C = 10\mu\text{A}, I_B = I_E = 0$	20	60	-	20	60	-	V	
Emitter-to-Base Breakdown Voltage	$V_{(BR)EBO}$	$I_E = 10\mu\text{A}, I_C = 0$	5	7	-	5	7	-	V	
DYNAMIC CHARACTERISTICS FOR EACH DIFFERENTIAL AMPLIFIER										
1/f Noise Figure (For Single Transistor) (Figure 12)	NF	$f = 100\text{kHz}, R_S = 500\Omega, I_C = 1\text{mA}$	-	1.5	-	-	1.5	-	dB	
Gain Bandwidth Product (For Single Transistor) (Figure 11)	f_T	$V_{CE} = 6\text{V}, I_C = 5\text{mA}$	-	1.35	-	-	1.35	-	GHz	
Collector-Base Capacitance (Figure 8)	C_{CB}	$I_C = 0, V_{CB} = 5\text{V}$	Note 3	-	0.28	-	-	0.28	-	pF
			Note 4	-	0.15	-	-	0.28	-	pF
Collector-Substrate Capacitance (Figure 8)	C_{CI}	$I_C = 0, V_{CI} = 5\text{V}$	-	1.65	-	-	1.65	-	pF	

CA3049, CA3102

Electrical Specifications $T_A = 25^\circ\text{C}$ (Continued)

PARAMETER	SYMBOL	TEST CONDITIONS	CA3102			CA3049			UNIT	
			MIN	TYP	MAX	MIN	TYP	MAX		
Common Mode Rejection Ratio	CMRR	$I_B = I_C = 2\text{mA}$	-	100	-	-	100	-	dB	
AGC Range, One Stage (Figure 2)	AGC	Bias Voltage = -6V	-	75	-	-	75	-	dB	
Voltage Gain, Single-Ended Output (Figures 2, 9, 10)	A	Bias Voltage = -4.2V, $f = 10\text{MHz}$	18	22	-	-	22	-	dB	
Insertion Power Gain (Figure 3)	G_p	$V_{CC} = 12\text{V}$, For Cascode Configuration	Cascode	-	23	-	-	23	-	dB
Noise Figure (Figure 3)	NF	For Cascode Configuration	Cascode	-	4.6	-	-	4.6	-	dB
Input Admittance	Y_{11}	$I_B = I_C = 2\text{mA}$, For Diff. Amp. Configuration	Cascode (Figures 14, 16, 18)	-	$1.5 + j2.45$	-	-	$1.5 + j2.45$	-	mS
			Diff. Amp. (Figures 15, 17, 19)	-	$0.878 + j1.3$	-	-	$0.878 + j1.3$	-	mS
Reverse Transfer Admittance	Y_{12}	$I_C \cong 2\text{mA}$, $f = 200\text{MHz}$	Cascode	-	$0.0 - j0.008$	-	-	$0.0 - j0.008$	-	mS
			Diff. Amp.	-	$0.0 - j0.013$	-	-	$0.0 - j0.013$	-	mS
Forward Transfer Admittance	Y_{21}		Cascode (Figures 26, 28, 30)	-	$17.9 - j30.7$	-	-	$17.9 - j30.7$	-	mS
			Diff. Amp. (Figures 27, 29, 31)	-	$-10.5 + j13$	-	-	$-10.5 + j13$	-	mS
Output Admittance	Y_{22}		Cascode (Figures 20, 22, 24)	-	$-0.503 - j15$	-	-	$-0.503 - j15$	-	mS
			Diff. Amp. (Figures 21, 23, 25)	-	$0.071 + j0.62$	-	-	$0.071 + j0.62$	-	mS

NOTES:

3. Terminals 1 and 14 or 7 and 8 (CA3102). Terminals 1 and 12 or 6 and 7 (CA3049T).
4. Terminals 13 and 4 or 6 and 11 (CA3102). Terminals 10 and 11 or 4 and 5 (CA3049T).

Schematic Diagrams

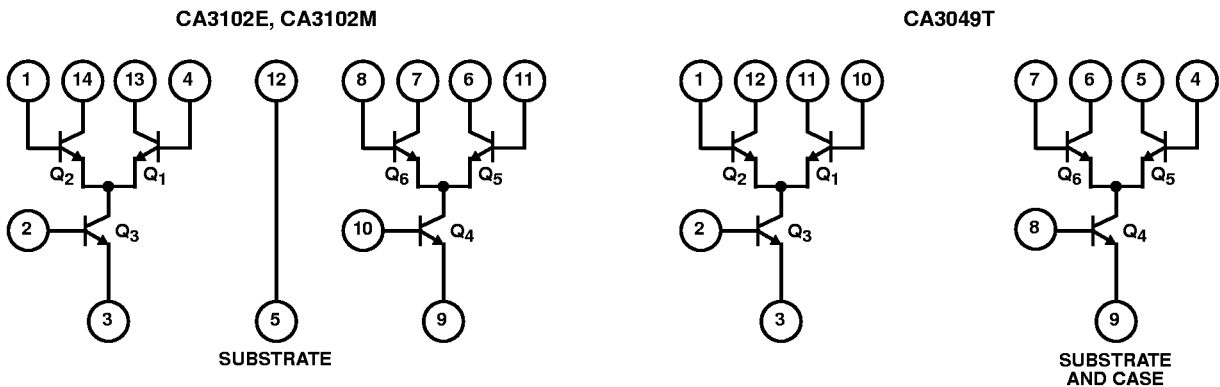

Test Circuits

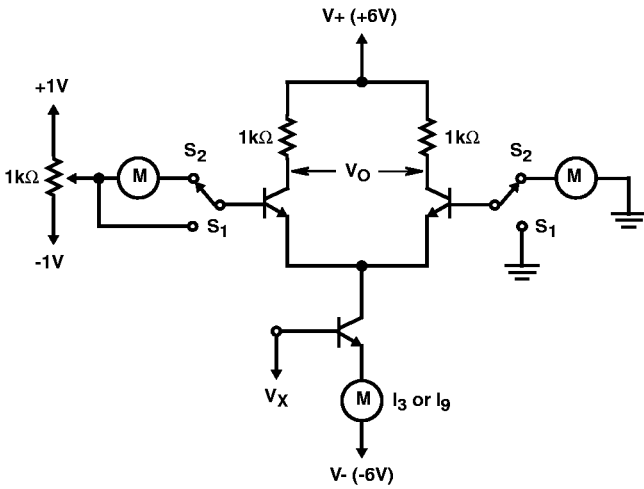

FIGURE 1. DC CHARACTERISTICS TEST CIRCUIT FOR CA3102

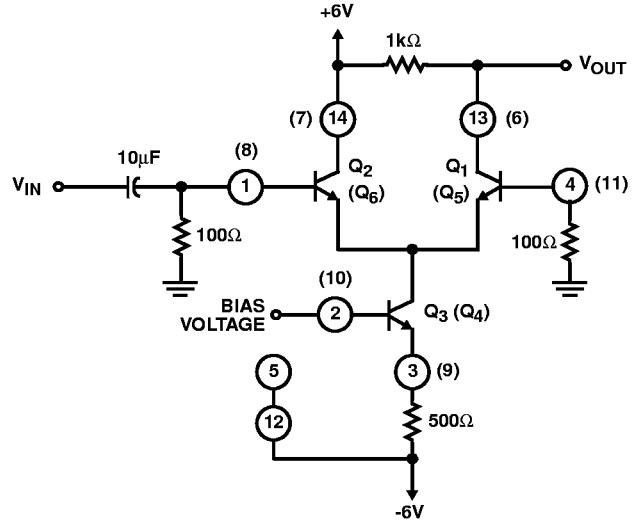
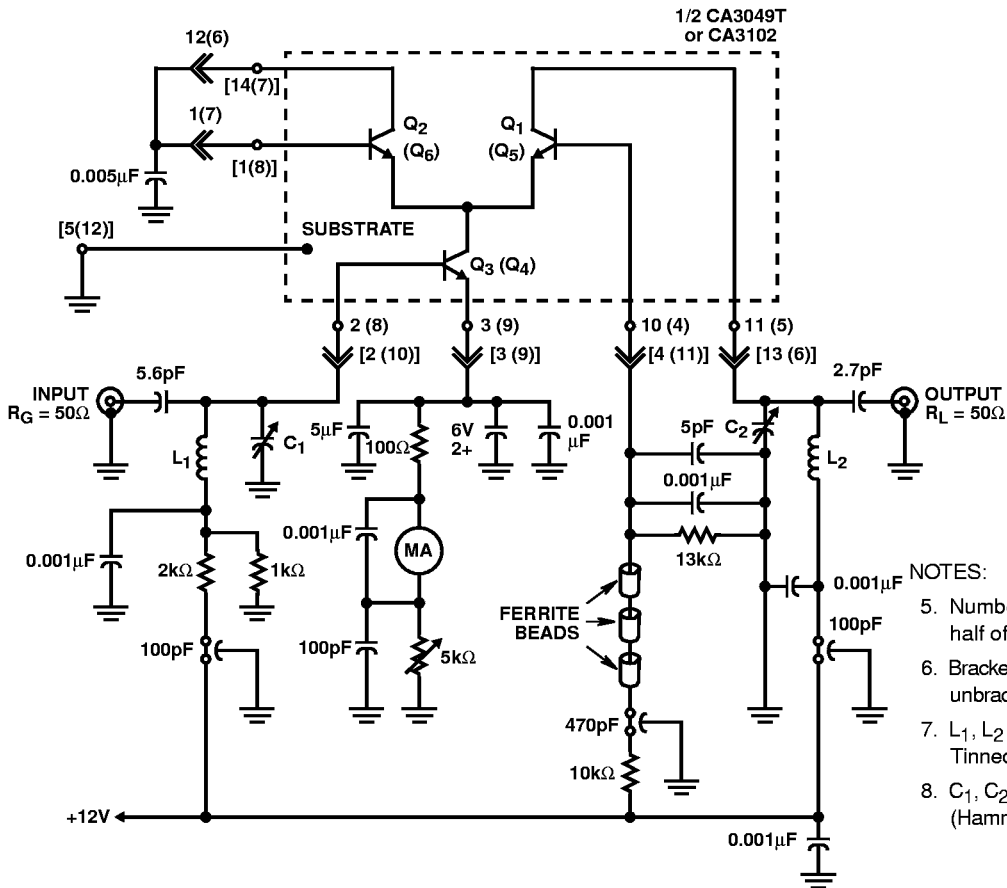

FIGURE 2. AGC RANGE AND VOLTAGE GAIN TEST CIRCUIT FOR CA3102



- NOTES:
5. Numbers in parentheses refer to other half of the CA3049T or CA3102.
 6. Bracketed numbers refer to CA3102, unbracketed numbers refer to CA3049T.
 7. L₁, L₂ - Approximately 1/2 Turn #18 Tinned Copper Wire, 5/8" Diameter.
 8. C₁, C₂ - 15pF Variable Capacitors (Hammarlund, MAC-15; or Equivalent).

FIGURE 3. 200MHz CASCODE POWER GAIN AND NOISE FIGURE TEST CIRCUIT

Typical Performance Curves

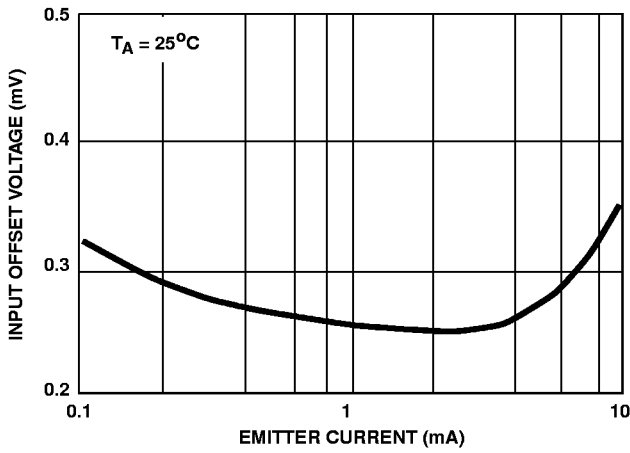

FIGURE 4. INPUT OFFSET VOLTAGE vs EMITTER CURRENT

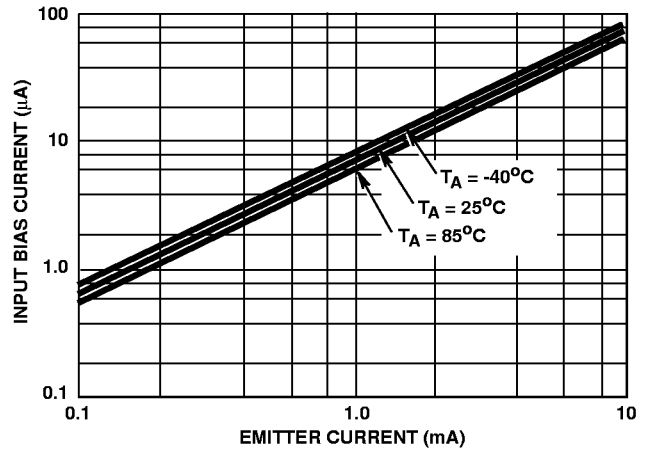

FIGURE 5. INPUT BIAS CURRENT vs EMITTER CURRENT

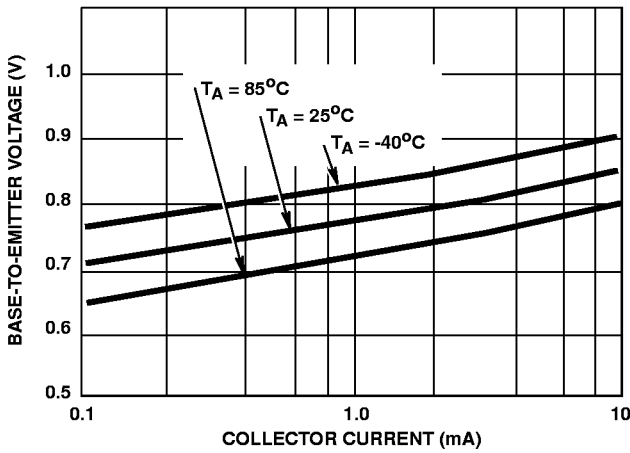

FIGURE 6. BASE-TO-EMITTER VOLTAGE vs COLLECTOR CURRENT

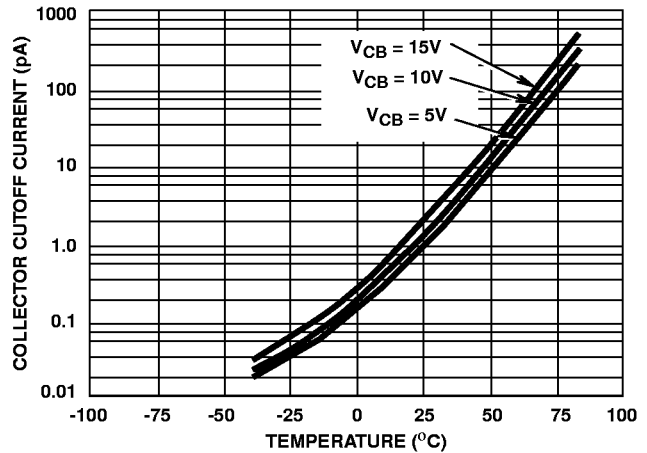

FIGURE 7. COLLECTOR CUTOFF CURRENT vs TEMPERATURE

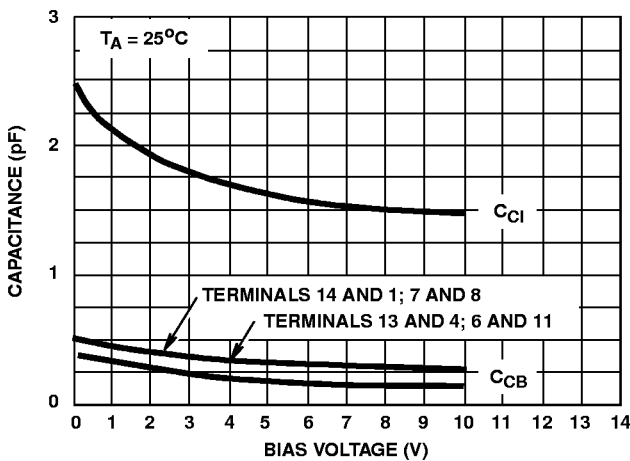

FIGURE 8. CAPACITANCE vs DC BIAS VOLTAGE

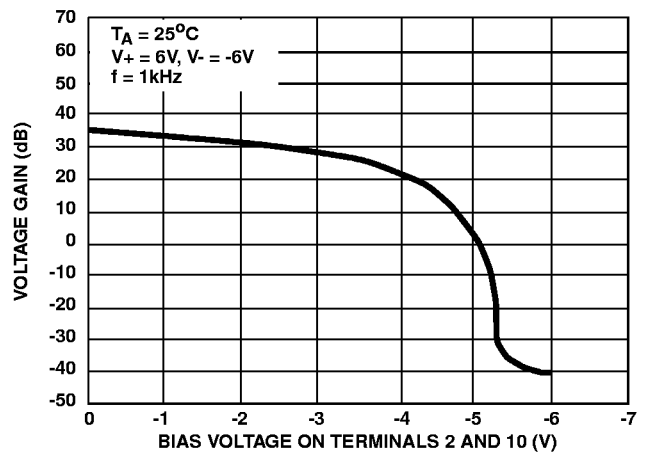

FIGURE 9. VOLTAGE GAIN vs DC BIAS VOLTAGE

Typical Performance Curves (Continued)

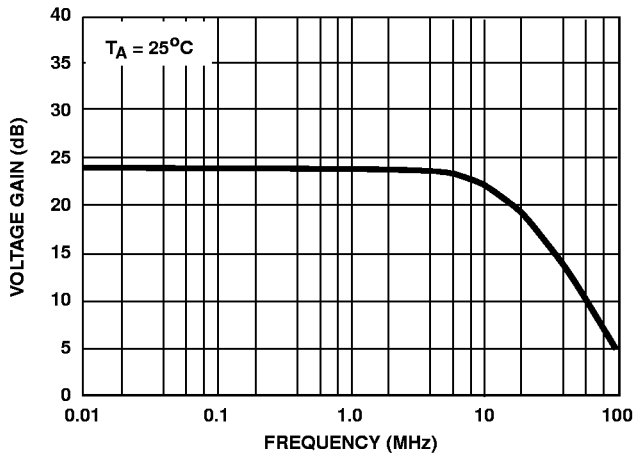

FIGURE 10. VOLTAGE GAIN vs FREQUENCY

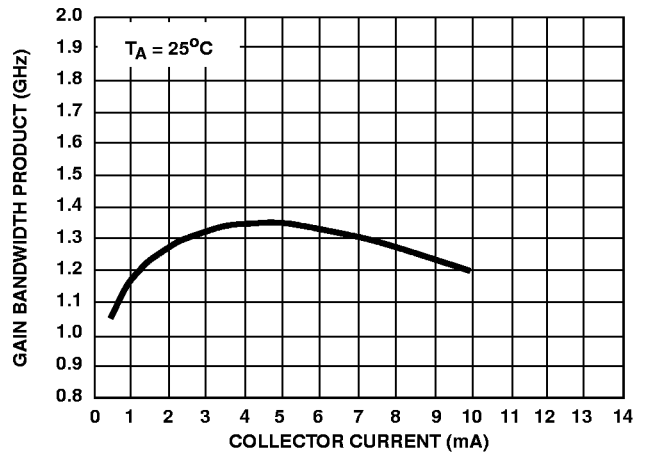

FIGURE 11. GAIN BANDWIDTH PRODUCT vs COLLECTOR CURRENT

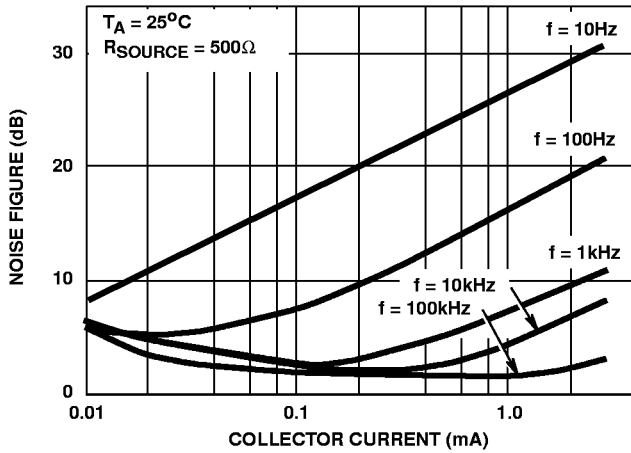

FIGURE 12. 1/f NOISE FIGURE vs COLLECTOR CURRENT

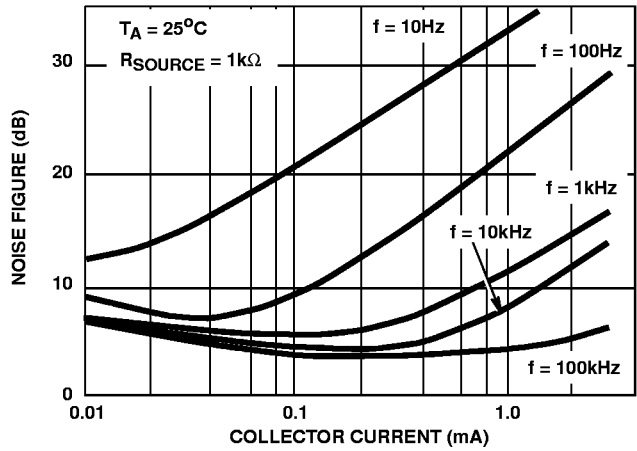

FIGURE 13. 1/f NOISE FIGURE vs COLLECTOR CURRENT

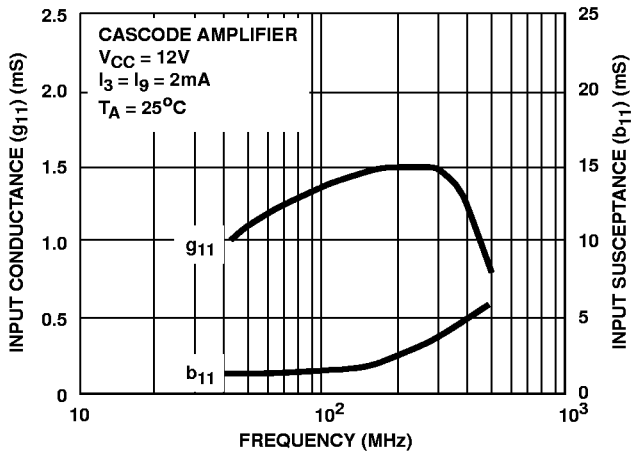

FIGURE 14. INPUT ADMITTANCE (Y_{11}) vs FREQUENCY

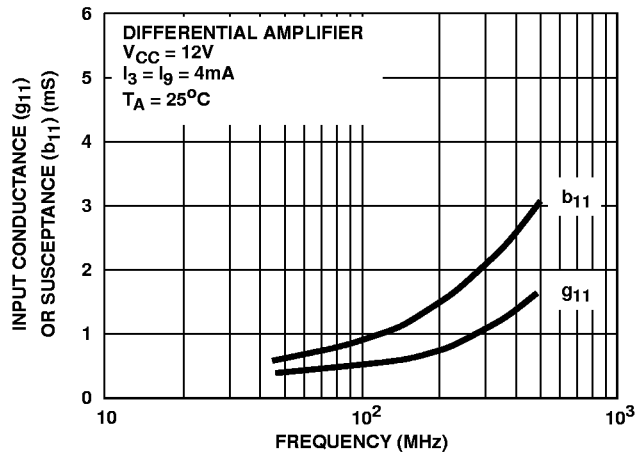

FIGURE 15. INPUT ADMITTANCE (Y_{11}) vs FREQUENCY

Typical Performance Curves (Continued)

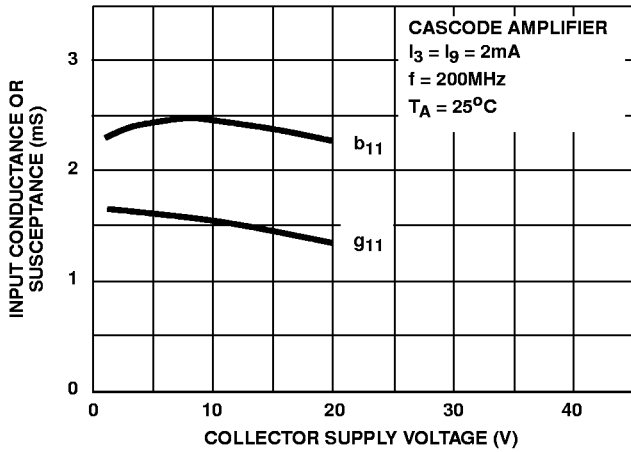

FIGURE 16. INPUT ADMITTANCE (Y_{11}) vs COLLECTOR SUPPLY VOLTAGE

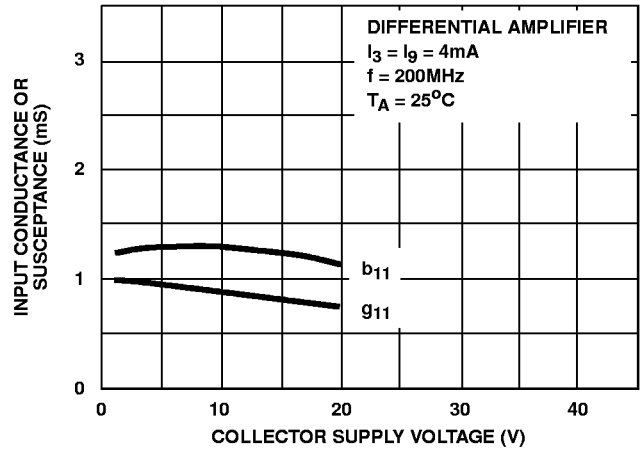

FIGURE 17. INPUT ADMITTANCE (Y_{11}) vs COLLECTOR SUPPLY VOLTAGE

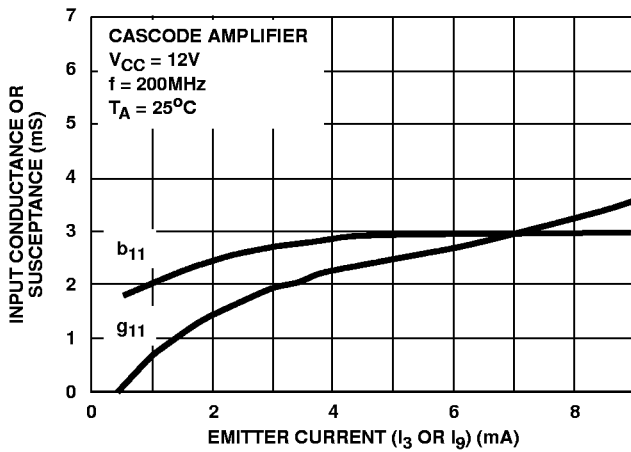

FIGURE 18. INPUT ADMITTANCE (Y_{11}) vs EMITTER CURRENT

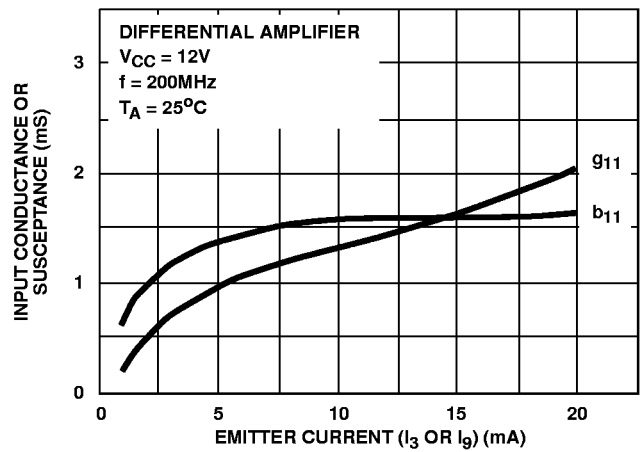

FIGURE 19. INPUT ADMITTANCE (Y_{11}) vs EMITTER CURRENT

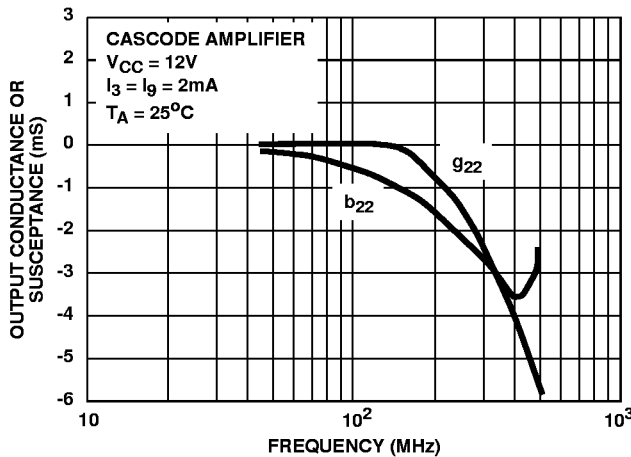

FIGURE 20. OUTPUT ADMITTANCE (Y_{22}) vs FREQUENCY

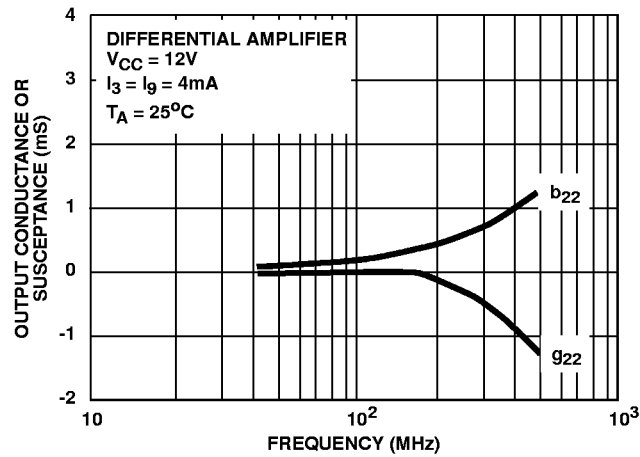

FIGURE 21. OUTPUT ADMITTANCE (Y_{22}) vs FREQUENCY

Typical Performance Curves (Continued)

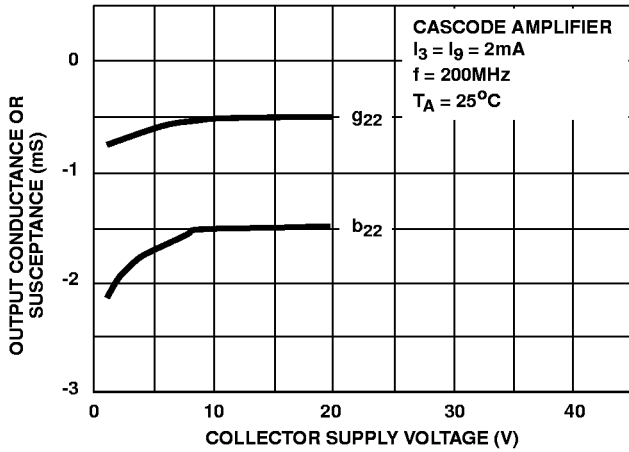

FIGURE 22. OUTPUT ADMITTANCE (Y_{22}) vs COLLECTOR SUPPLY VOLTAGE

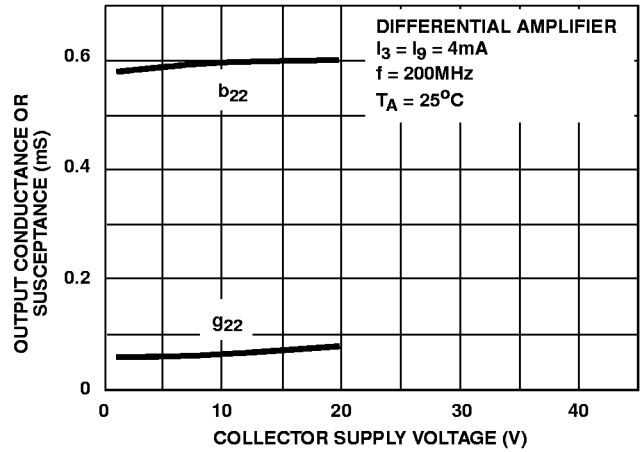

FIGURE 23. OUTPUT ADMITTANCE (Y_{22}) vs COLLECTOR SUPPLY VOLTAGE

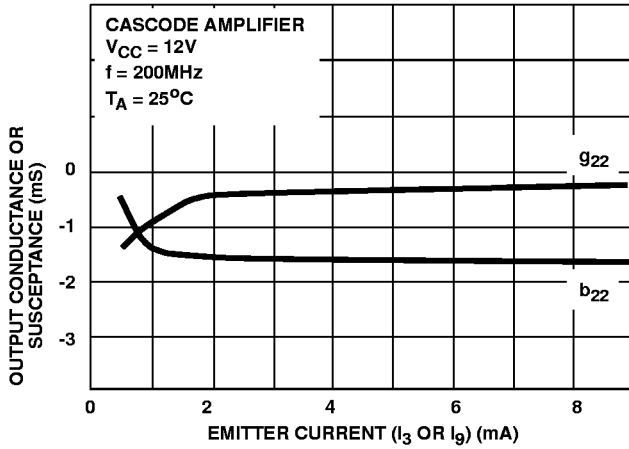

FIGURE 24. OUTPUT ADMITTANCE (Y_{22}) vs EMITTER CURRENT

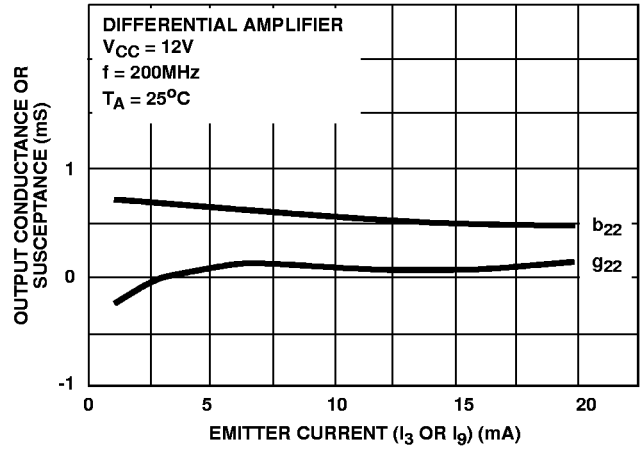

FIGURE 25. OUTPUT ADMITTANCE (Y_{22}) vs EMITTER CURRENT

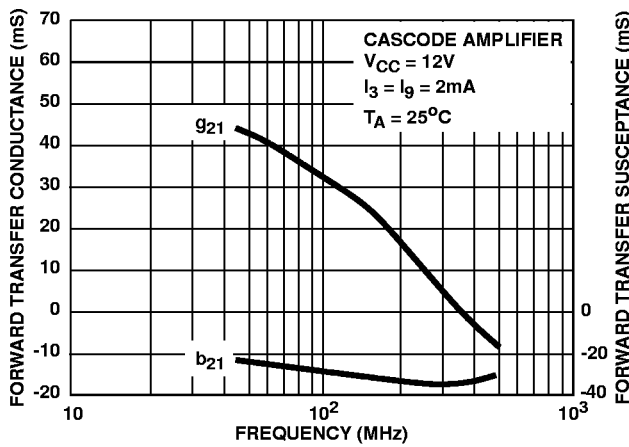

FIGURE 26. FORWARD TRANSFER ADMITTANCE (Y_{21}) vs FREQUENCY

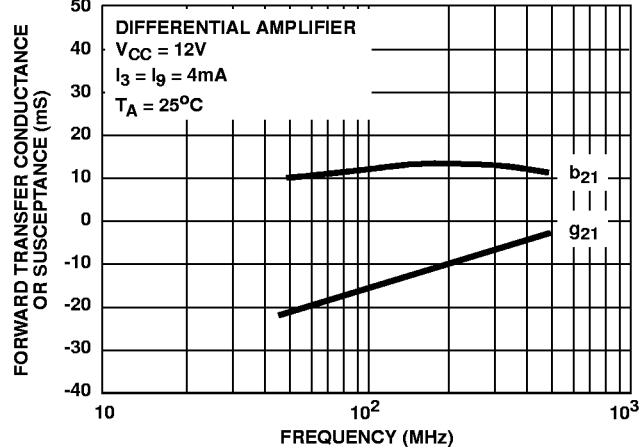

FIGURE 27. FORWARD TRANSFER ADMITTANCE (Y_{21}) vs FREQUENCY

Typical Performance Curves (Continued)

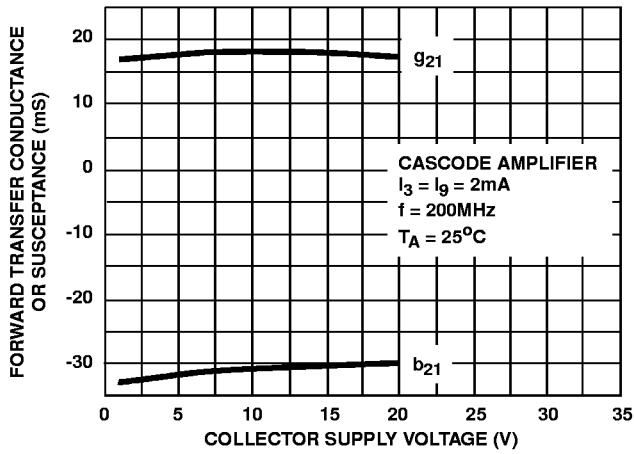

FIGURE 28. FORWARD TRANSFER ADMITTANCE (Y_{21}) vs COLLECTOR SUPPLY VOLTAGE

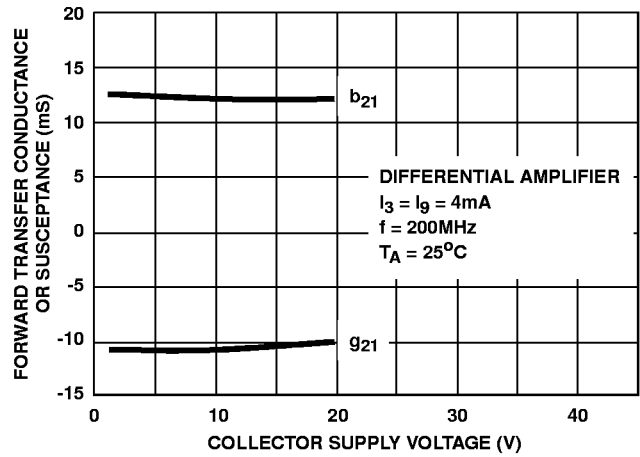

FIGURE 29. FORWARD TRANSFER ADMITTANCE (Y_{21}) vs COLLECTOR SUPPLY VOLTAGE

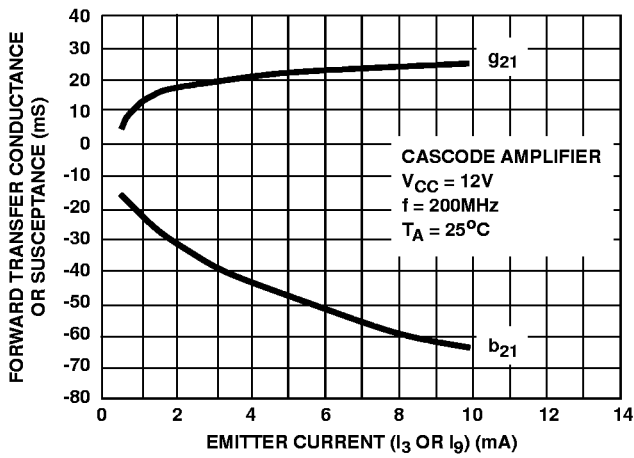

FIGURE 30. FORWARD TRANSFER ADMITTANCE (Y_{21}) vs EMITTER CURRENT

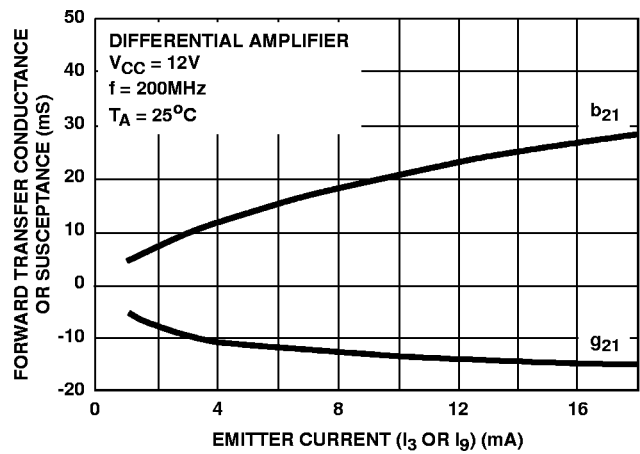

FIGURE 31. FORWARD TRANSFER ADMITTANCE (Y_{21}) vs EMITTER CURRENT