

NPN Silicon RF Transistor

Preliminary data

- For high power amplifiers
- Compression point $P_{-1\text{dB}} = 26.5 \text{ dBm}$ at 1.8 GHz
maxim. available Gain $G_{\text{ma}} = 9.5 \text{ dB}$ at 1.8 GHz
- Transition frequency $f_T > 17 \text{ GHz}$
- Gold metalization for high reliability
- **SIEGET[®] 25 - Line**
Siemens Grounded Emitter Transistor
25 GHz f_T - Line

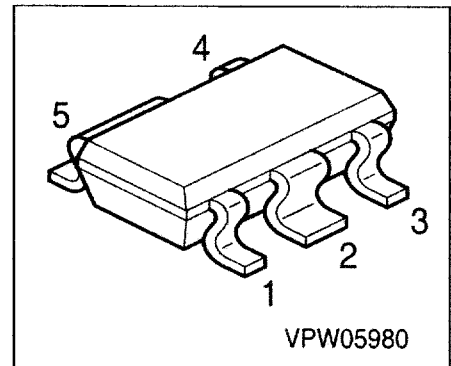

ESD: Electrostatic discharge sensitive device, observe handling precaution!

Type	Marking	Ordering Code	Pin Configuration					Package
BFP 490	AOs	Q62702-F1721	1 = B	2 = E	3 = C	4 = C	5 = E	SCT-595

Maximum Ratings

Parameter	Symbol	Value	Unit
Collector-emitter voltage	V_{CEO}	4.5	V
Collector-base voltage	V_{CBO}	15	
Emitter-base voltage	V_{EBO}	1.5	
Collector current	I_{C}	600	mA
Base current	I_{B}	60	
Total power dissipation, $T_{\text{S}} \leq 85 \text{ }^\circ\text{C}$	P_{tot}	1000	mW
Junction temperature	T_{j}	150	$^\circ\text{C}$
Ambient temperature	T_{A}	-65 ... +150	
Storage temperature	T_{stg}	-65 ... +150	

Thermal Resistance

Junction - soldering point ¹⁾	R_{thJS}	≤ 65	K/W
--	-------------------	-----------	-----

1) T_{S} is measured on the emitter lead at the soldering point mounted on alumina 15 mm x 16,7 mm x 0.7 mm

Electrical Characteristics at $T_A = 25^\circ\text{C}$, unless otherwise specified.

Parameter	Symbol	Values			Unit
		min.	typ.	max.	
DC characteristics					
Collector-emitter breakdown voltage $I_C = 1\text{ mA}, I_B = 0$	$V_{(BR)CEO}$	4.5	5	-	V
Collector-base cutoff current $V_{CB} = 5\text{ V}, I_E = 0$	I_{CBO}	-	-	1800	nA
Emitter-base cutoff current $V_{EB} = 1.5\text{ V}, I_C = 0$	I_{EBO}	-	-	400	μA
DC current gain $I_C = 200\text{ mA}, V_{CE} = 3\text{ V}$	h_{FE}	50	90	-	-
AC characteristics					
Transition frequency $I_C = 300\text{ mA}, V_{CE} = 3\text{ V}, f = 0.2\text{ GHz}$ $I_C = 300\text{ mA}, V_{CE} = 3\text{ V}, f = 0.5\text{ GHz}$	f_T	- 13	17.5 15	- -	GHz
Collector-base capacitance $V_{CB} = 2\text{ V}, f = 1\text{ MHz}$	C_{cb}	-	3.7	4.7	pF
Collector-emitter capacitance $V_{CE} = 2\text{ V}, f = 1\text{ MHz}$	C_{ce}	-	6.3	-	
Emitter-base capacitance $V_{EB} = 0.5\text{ V}, f = 1\text{ MHz}$	C_{eb}	-	10.5	-	
Noise figure $I_C = 100\text{ mA}, V_{CE} = 2\text{ V}, Z_S = Z_{Sopt},$ $f = 1.8\text{ GHz}$	F	-	3.3	-	dB
Power gain ²⁾ $I_C = 200\text{ mA}, V_{CE} = 2\text{ V}, Z_S = Z_{Sopt}, Z_L = Z_{Lopt},$ $f = 1.8\text{ GHz}$	G_{ma}	-	9	-	dB
Insertion power gain $I_C = 200\text{ mA}, V_{CE} = 2\text{ V}, f = 0.5\text{ GHz},$ $Z_S = Z_L = 50\Omega$	$ S_{21} ^2$	-	8.5	-	dB
Third order intercept point $I_C = 300\text{ mA}, V_{CE} = 3\text{ V}, Z_S = Z_{Sopt}, Z_L = Z_{Lopt},$ $f = 1.8\text{ GHz}$	IP_3	-	35	-	dBm
1dB Compression point $I_C = 300\text{ mA}, V_{CE} = 3\text{ V}, f = 1.8\text{ GHz},$ $Z_S = Z_{Sopt}, Z_L = Z_{Lopt}$	P_{-1dB}	-	26.5	-	

$$2) G_{ma} = |S_{21} / S_{12}| (k - (k^2 - 1)^{1/2})$$

Common Emitter S-Parameters

f GHz	S ₁₁		S ₂₁		S ₁₂		S ₂₂	
	MAG	ANG	MAG	ANG	MAG	ANG	MAG	ANG
V _{CE} = 2V, I _C = 150mA								
0.01	0.648	-159.8	75.95	144.1	0.0053	53.8	0.7723	-77.6
0.1	0.916	-178.5	12.96	94.9	0.0095	25.5	0.8743	-167.1
0.3	0.921	173.7	4.28	83.7	0.0133	43.6	0.8761	-179.6
0.5	0.92	168.2	2.52	77.3	0.0188	51.9	0.8777	175.7
0.9	0.921	159.1	1.36	68.1	0.0295	56.1	0.8825	169.5
1	0.919	157	1.22	65.7	0.0321	55.7	0.9944	168.2
1.5	0.928	147.1	0.8	55.6	0.045	52.7	0.8861	162.5
2	0.926	138.8	0.61	47.1	0.0574	48.1	0.8878	157.7
3	0.924	122.8	0.43	29.1	0.0811	36.6	0.884	146.7

V_{CE} = 2V, I_C = 300mA

0.01	0.7274	-172.3	63.82	153.8	0.003	38.4	0.4321	-91.1
0.1	0.9158	-179.6	14.24	98.6	0.007	34.6	0.8696	-167
0.3	0.9215	173.1	4.735	85.3	0.0119	53.6	0.8834	-179.5
0.5	0.9193	167.9	2.788	78.7	0.0179	59.4	0.8879	175.8
0.9	0.9224	158.9	1.515	69.8	0.0294	60.8	0.892	169.5
1	0.9201	156.7	1.358	67.5	0.0324	59.8	0.8952	168.1
1.5	0.9373	147	0.891	57.7	0.0454	55.5	0.8953	162.2
2	0.9265	138.6	0.672	49.4	0.0581	50.3	0.8968	157.5
3	0.9204	122.7	0.47	31.7	0.0819	37.9	0.8928	146.5

For more and detailed S- parameters please contact your local Siemens distributor or sales office to obtain a Siemens Application Notes CD-ROM or see Internet: <http://www.siemens.de/Semiconductor/products/35/35.htm>

SPICE Parameters (Gummel-Poon Model, Berkley-SPICE 2G.6 Syntax) :

Transistor Chip Data

IS =	0.451	fA	BF =	114.96	-	NF =	1.1472	-
VAF =	24.665	V	IKF =	0.76939	A	ISE =	1.1591	pA
NE =	1.9962	-	BR =	21.04	-	NR =	1.3531	-
VAR =	16.035	V	IKR =	0.090033	A	ISC =	3.7479	A
NC =	1.339	-	RB =	1.0754	Ω	IRB =	0.17683	mA
RBM =	2.1262	Ω	RE =	0.32476		RC =	0.10737	Ω
CJE =	1.227	fF	VJE =	0.93266	V	MJE =	0.36885	-
TF =	3.9147	ps	XTF =	0.61664	-	VTF =	0.27348	V
ITF =	3.2793	mA	PTF =	0	deg	CJC =	6.12521	fF
VJC =	0.9832	V	MJC =	0.34153	-	XCJC =	0.3	-
TR =	1.115	ns	CJS =	0	F	VJS =	0	V
MJS =	0	-	XTB =	0	-	EG =	1.11	eV
XTI =	0	-	FC =	0.75835	-	TNOM	300	K

C'-E'-Diode Data (Berkley-SPICE 2G.6 Syntax) :

IS =	tbd	fA	N =	tbd	-	RS =	tbd	Ω
------	-----	----	-----	-----	---	------	-----	----------

All parameters are ready to use, no scaling is necessary

Package Equivalent Circuit:

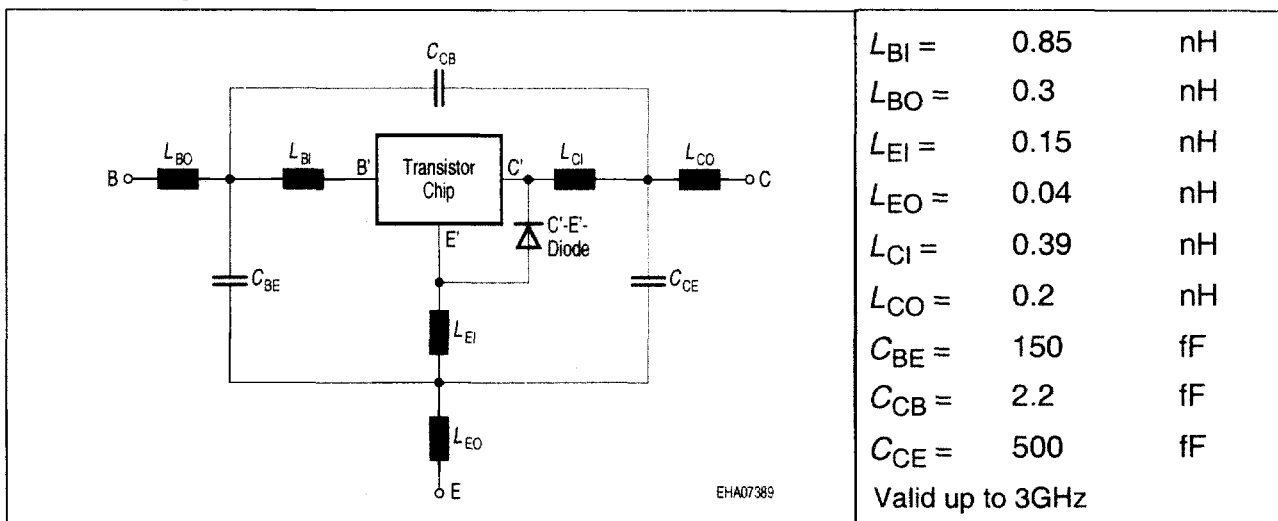

The SOT-595 package has two emitter leads. To avoid high complexity of the package equivalent circuit, both leads are combined in one electrical connection.

Extracted on behalf of SIEMENS Small Signal Semiconductors by:
 Institut für Mobil-und Satellitentechnik (IMST)
 © 1996 SIEMENS AG

For examples and ready to use parameters please contact your local Siemens distributor or sales office to obtain a Siemens CD-ROM or see Internet: <http://www.siemens.de/Semiconductor/products/35/35.htm>

For non-linear simulation:

- Use transistor chip parameters in Berkeley SPICE 2G.6 syntax for all simulators.
- If you need simulation of the reverse characteristics, add the diode with the C'-E'- diode data between collector and emitter.
- Simulation of package is not necessary for frequencies < 100MHz.
For higher frequencies add the wiring of package equivalent circuit around the non-linear transistor and diode model.

Note:

- This transistor is constructed in a common emitter configuration. This feature causes an additional reverse biased diode between emitter and collector, which does not effect normal operation.

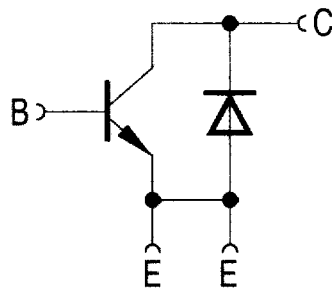

EHA07307

Transistor Schematic Diagram

The common emitter configuration shows the following advantages:

- Higher gain because of lower emitter inductance.
- Power is dissipated via the grounded emitter leads, because the chip is mounted on copper emitter leadframe.

Please note, that the broadest lead is the emitter lead.

The AC characteristics are verified by random sampling.

Total power dissipation $P_{tot} = f(T_A^*, T_S)$

* Package mounted on epoxy

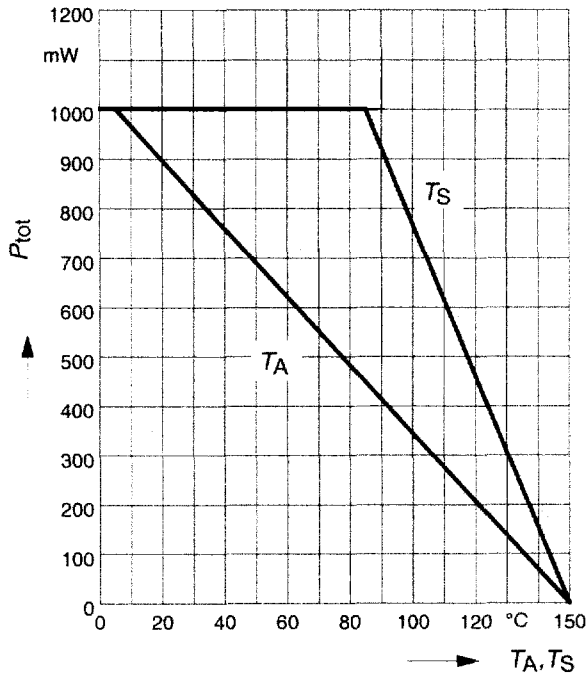

Transition frequency $f_T = f(I_C)$

$f = 200$ MHz

V_{CE} = parameter in V

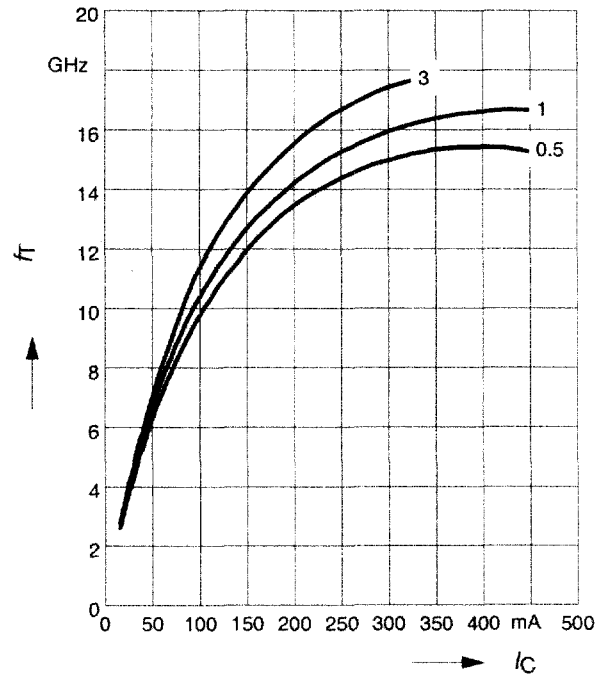

Permissible Pulse Load $R_{thJS} = f(t_p)$

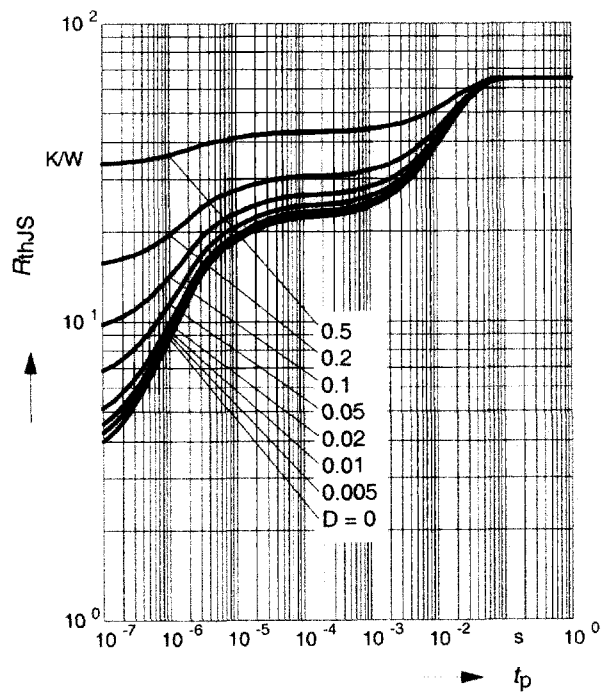

Permissible Pulse Load

$P_{totmax}/P_{totDC} = f(t_p)$

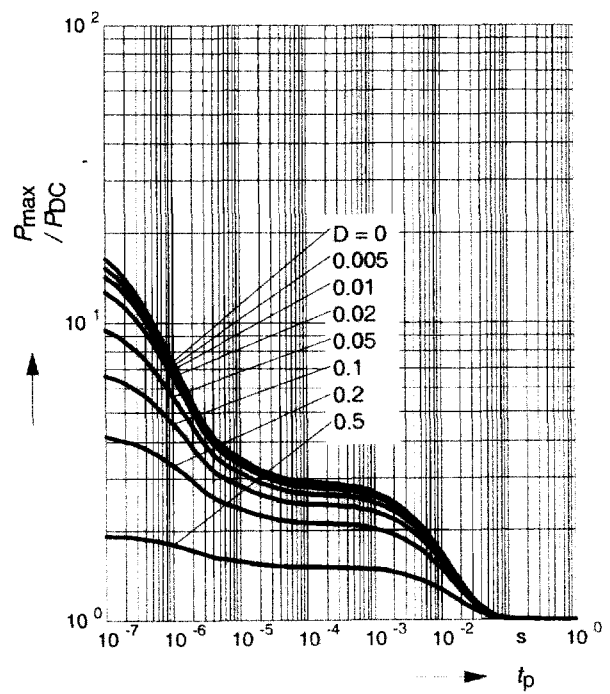

Power gain $G_{ma}, G_{ms}, |S_{21}|^2 = f(f)$

$V_{CE} = 2\text{ V}, I_C = 200\text{ mA}$

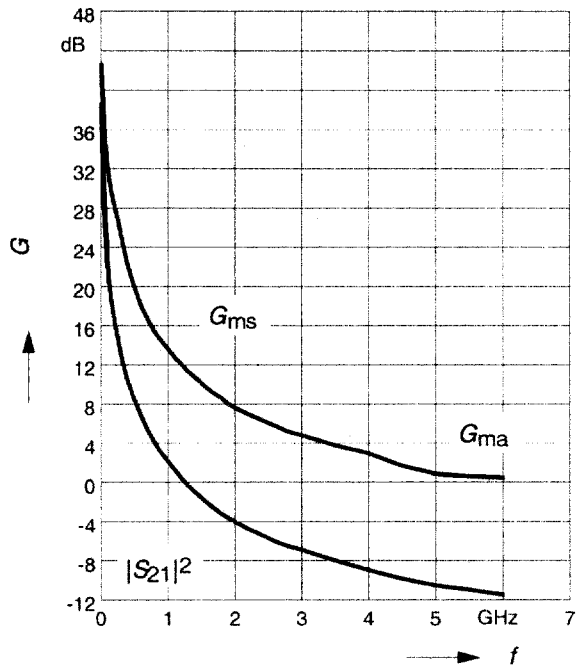

Power gain $G_{ma}, G_{ms} = f(I_C)$

$V_{CE} = 2\text{ V}$

$f = \text{parameter in GHz}$

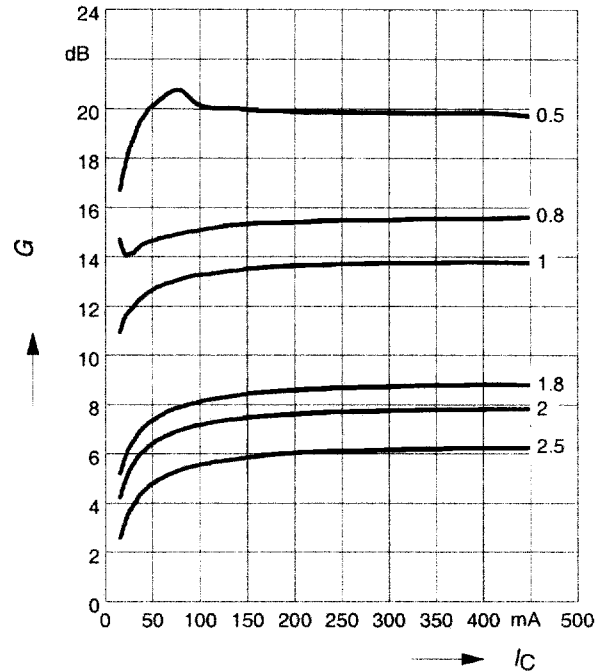

Power gain $G_{ma}, G_{ms} = f(V_{CE})$

$I_C = 200\text{ mA}$

$f = \text{parameter in GHz}$

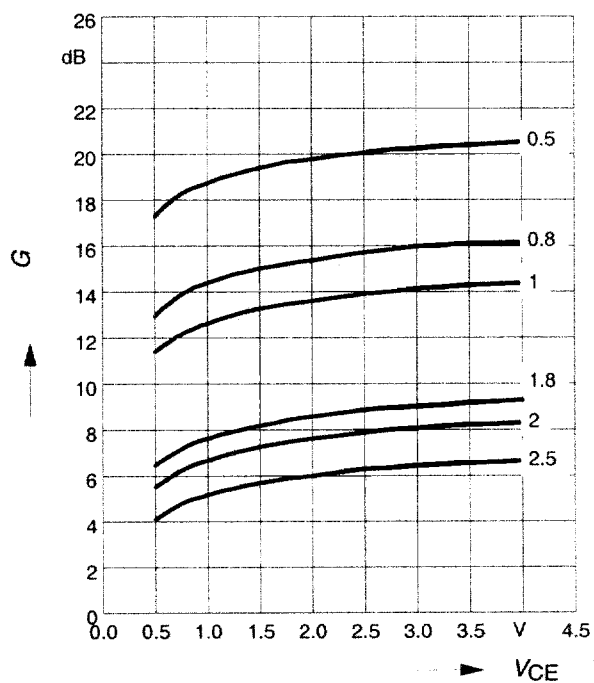

Collector-base capacitance $C_{cb} = f(V_{CB})$

$V_{BE} = 0, f = 1\text{ MHz}$

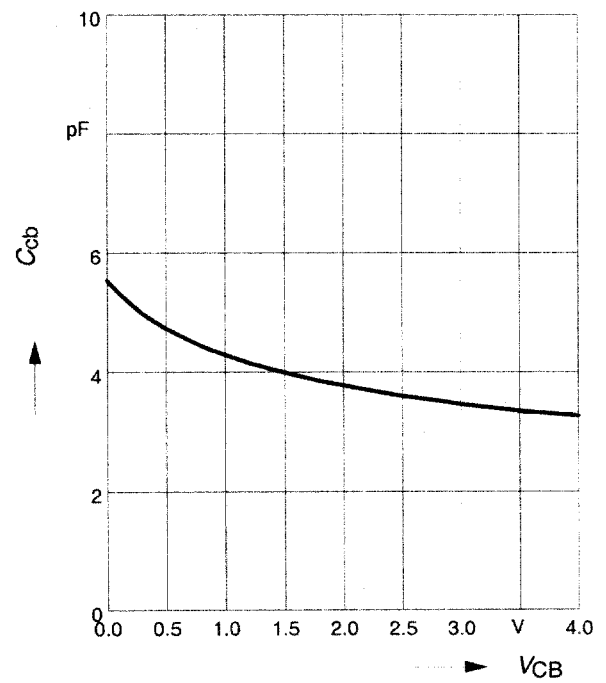

Noise figure $F = f(I_C)$

$V_{CE} = 2 \text{ V}$, $Z_S = Z_{Sopt}$

