

39µA Micropower Rail-to-Rail Input-Output Low Input Bias Current (RRIO) Op Amp

The ISL28166 is a micropower precision operational amplifier optimized for single supply operation at 5V and can operate down to 2.4V.

This device features an Input Range Enhancement Circuit (IREC), which enables it to maintain CMRR performance for input voltages greater than the positive supply. The input signal is capable of swinging 0.5V above a 5.0V supply (0.25 for a 2.5V supply) and to within 10mV from ground. The output operation is rail-to-rail.

The 1/f corner of the voltage noise spectrum is at 1kHz. This results in low frequency noise performance, which can only be found on device with an order of magnitude higher than the supply current.

The ISL28166 can be operated from one lithium cell or two Ni-Cd batteries. The input range includes both positive and negative rail. The output swings to both rails.

Ordering Information

PART NUMBER (Note 2)	PART MARKING	PACKAGE (Pb-Free)	PKG. DWG. #
ISL28166FHZ-T7 (Note 1)	GABY (Note 3)	6 Ld SOT-23	P6.064A
ISL28166EVAL1Z	Evaluation Board		

1. Please refer to [TB347](#) for details on reel specifications.
2. These Intersil Pb-free plastic packaged products employ special Pb-free material sets, molding compounds/die attach materials, and 100% matte tin plate plus anneal (e3 termination finish, which is RoHS compliant and compatible with both SnPb and Pb-free soldering operations). Intersil Pb-free products are MSL classified at Pb-free peak reflow temperatures that meet or exceed the Pb-free requirements of IPC/JEDEC J STD-020.
3. The part marking is located on the bottom of the parts.

Features

- 39µA typical supply current
- 5nA max input bias current
- 250kHz gain bandwidth product ($A_V = 1$)
- 2.4V to 5V single supply voltage range
- Rail-to-rail input and output
- Enable pin
- Pb-free (RoHS compliant)

Applications

- Battery- or solar-powered systems
- 4mA to 20mA current loops
- Handheld consumer products
- Medical devices
- Sensor amplifiers
- ADC buffers
- DAC output amplifiers

Pinouts

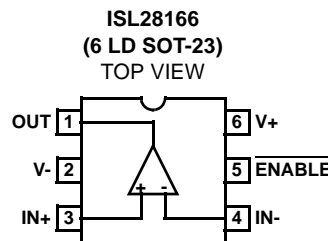

Absolute Maximum Ratings ($T_A = +25^\circ\text{C}$)

Supply Voltage	5.5V
Supply Turn-on Voltage Slew Rate	1V/ μs
Differential Input Current	5mA
Differential Input Voltage	0.5V
Input Voltage	V ₋ - 0.5V to V ₊ + 0.5V
ESD Rating	
Human Body Model	.3kV
Machine Model	.300V
Charged Device Model	1500V

Thermal Information

Thermal Resistance (Typical Note 4)	θ_{JA} ($^\circ\text{C}/\text{W}$)
6 Ld SOT-23 Package	230
Output Short-Circuit Duration	Indefinite
Ambient Operating Temperature Range	-40 $^\circ\text{C}$ to +125 $^\circ\text{C}$
Storage Temperature Range	-65 $^\circ\text{C}$ to +150 $^\circ\text{C}$
Operating Junction Temperature	+125 $^\circ\text{C}$
Pb-Free Reflow Profile	see link below
	http://www.intersil.com/pbfree/Pb-FreeReflow.asp

CAUTION: Do not operate at or near the maximum ratings listed for extended periods of time. Exposure to such conditions may adversely impact product reliability and result in failures not covered by warranty.

NOTE:

4. θ_{JA} is measured with the component mounted on a high effective thermal conductivity test board in free air. See Tech Brief [TB379](#) for details.

IMPORTANT NOTE: All parameters having Min/Max specifications are guaranteed. Typical values are for information purposes only. Unless otherwise noted, all tests are at the specified temperature and are pulsed tests, therefore: $T_J = T_C = T_A$

Electrical Specifications $V_+ = 5\text{V}$, $V_- = 0\text{V}$, $V_{CM} = 2.5\text{V}$, $T_A = +25^\circ\text{C}$ unless otherwise specified. **Boldface limits apply over the operating temperature range, -40 $^\circ\text{C}$ to +125 $^\circ\text{C}$.** Temperature data established by characterization.

PARAMETER	DESCRIPTION	CONDITIONS	MIN (Note 5)	TYP	MAX (Note 5)	UNIT
V_{OS}	Input Offset Voltage		-700	-7	700	μV
			-800		800	
$\frac{\Delta V_{OS}}{\Delta T}$	Input Offset Drive vs Temperature			1.5		$\mu\text{V}/^\circ\text{C}$
I_{OS}	Input Offset Current		-1.5	0.34	1.2	nA
			-5		2.5	
I_B	Input Bias Current		-5	1.14	5	nA
			-5.5		5.5	
E_N	Input Noise Voltage Density	$F_O = 1\text{kHz}$		46		$\text{nV}/\sqrt{\text{Hz}}$
I_N	Input Noise Current Density	$F_O = 1\text{kHz}$		0.14		$\text{pA}/\sqrt{\text{Hz}}$
CMIR	Input Common-Mode Voltage Range		0		5	V
CMRR	Common-Mode Rejection Ratio	$V_{CM} = 0\text{V}$ to 5V	80	110		dB
			75			
PSRR	Power Supply Rejection Ratio	$V_S = 2.4\text{V}$ to 5V	90	104		dB
			75			
A_{VOL}	Large Signal Voltage Gain	$V_O = 0.5\text{V}$ to 4.5V, $R_L = 100\text{k}\Omega$	200	412		V/mV
			175			
		$V_O = 0.5\text{V}$ to 4.5V, $R_L = 1\text{k}\Omega$	35	70		V/mV
			30			
V_{OUT}	Maximum Output Voltage Swing	Output low, $R_L = 100\text{k}\Omega$		3	6	mV
			8			
		Output low, $R_L = 1\text{k}\Omega$		130	150	mV
			200			
		Output high, $R_L = 100\text{k}\Omega$	4.992	4.995		V
			4.99			
Output high, $R_L = 1\text{k}\Omega$	4.85	4.88		V		
	4.8					
SR	Slew Rate			0.05		V/ μs
GBW	Gain Bandwidth Product	$A_V = 1$		250		kHz

Electrical Specifications $V_+ = 5V, V_- = 0V, V_{CM} = 2.5V, T_A = +25^\circ C$ unless otherwise specified. **Boldface limits apply over the operating temperature range, -40°C to +125°C.** Temperature data established by characterization. (Continued)

PARAMETER	DESCRIPTION	CONDITIONS	MIN (Note 5)	TYP	MAX (Note 5)	UNIT
$I_{S,ON}$	Supply Current, Enabled			39	47	μA
					56	
$I_{S,OFF}$	Supply Current, Disabled			10	14	μA
					16	
I_{O+}	Short-Circuit Output Current	$R_L = 10\Omega$	28	31		mA
			23			
I_{O-}	Short-Circuit Output Current	$R_L = 10\Omega$		-26	-24	mA
					-18	
V_{SUPPLY}	Supply Operating Range	Guaranteed by PSRR test	2.4		5	V
V_{INH}	Enable Pin High Level		2			V
V_{INL}	Enable Pin Low Level				0.8	V
I_{ENH}	Enable Pin Input Current	$V_{EN} = 5V$		1	1.2	μA
					1.2	
I_{ENL}	Enable Pin Input Current	$V_{EN} = 0V$		16	25	nA
					30	
t_{EN}	Enable to output on-state delay time	$V_{OUT} = 1V$ (enable state); $V_{EN} = \text{High-to-Low}$		10.8		μs
$t_{\overline{EN}}$	Enable to output off-state delay time	$V_{OUT} = 0V$ (disabled state) $V_{EN} = \text{Low-to-High}$		0.1		μs

NOTE:

- 5. Parameters with MIN and/or MAX limits are 100% tested at +25°C, unless otherwise specified. Temperature limits established by characterization and are not production tested.

Typical Performance Curves

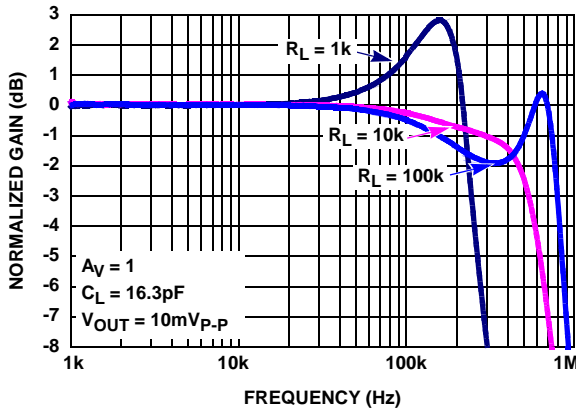

FIGURE 1. GAIN vs FREQUENCY vs R_L

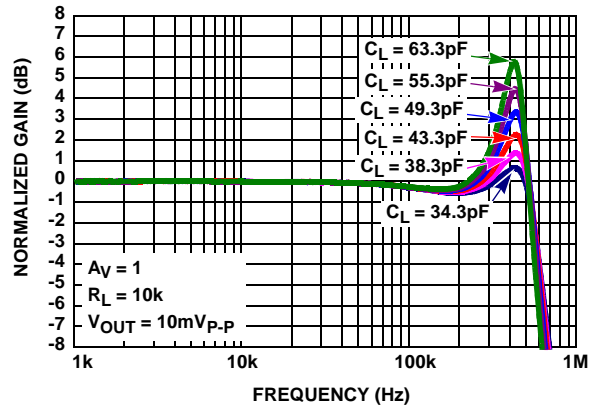

FIGURE 2. GAIN vs FREQUENCY vs C_L

Typical Performance Curves (Continued)

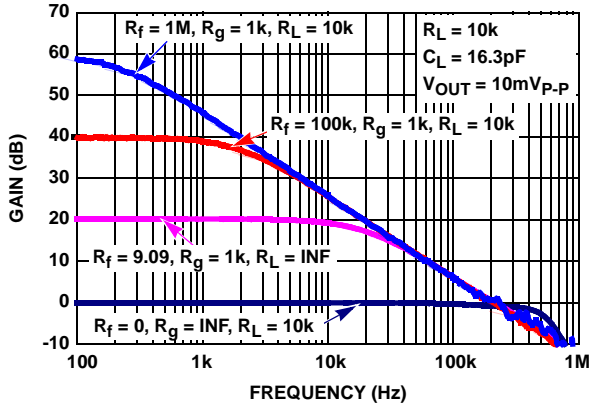

FIGURE 3. CLOSED LOOP GAIN vs FREQUENCY

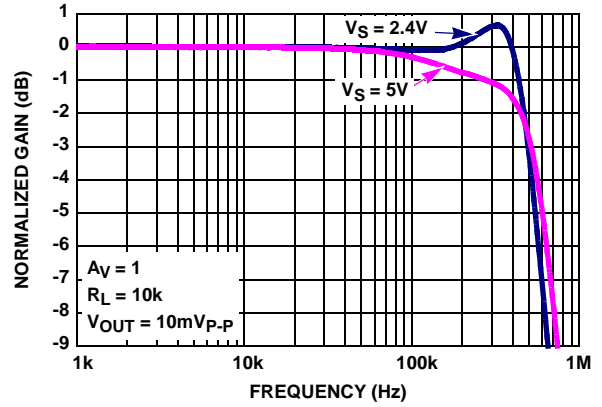

FIGURE 4. GAIN vs FREQUENCY vs V_S

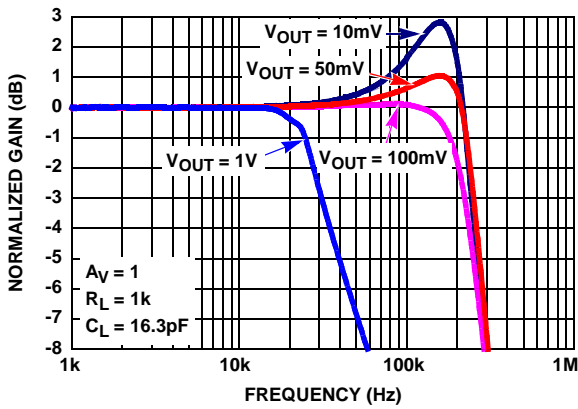

FIGURE 5. GAIN vs FREQUENCY vs V_{OUT}

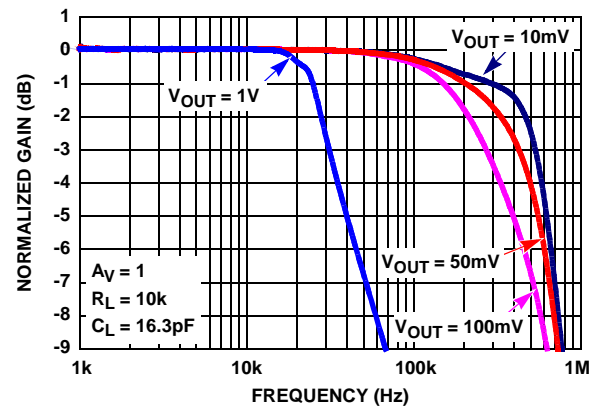

FIGURE 6. GAIN vs FREQUENCY vs V_{OUT}

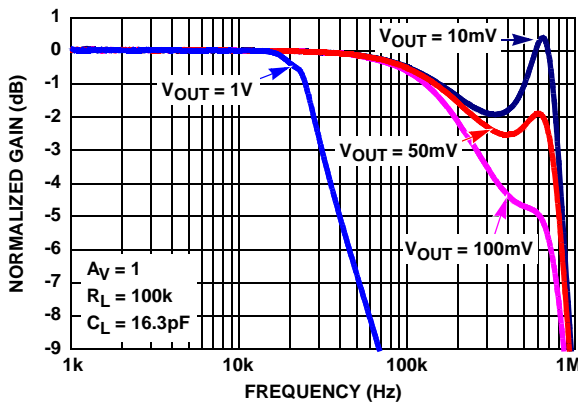

FIGURE 7. GAIN vs FREQUENCY vs V_{OUT}

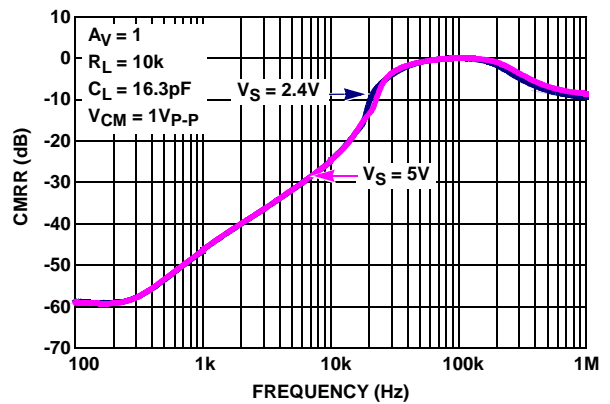

FIGURE 8. CMRR vs FREQUENCY

Typical Performance Curves (Continued)

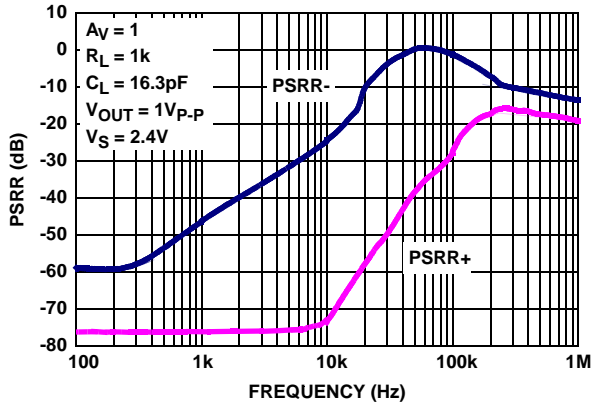

FIGURE 9. PSRR vs FREQUENCY, $V_S = 2.4V$

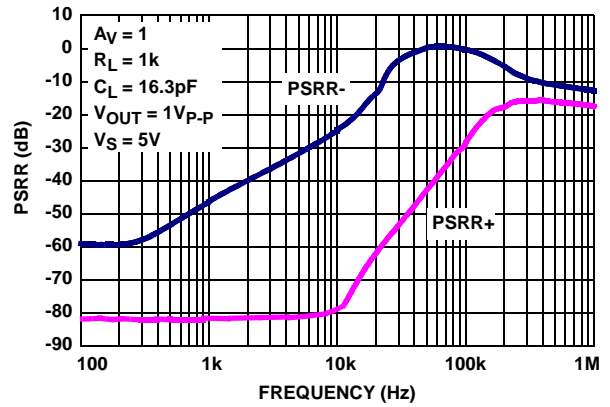

FIGURE 10. PSRR vs FREQUENCY, $V_S = 5V$

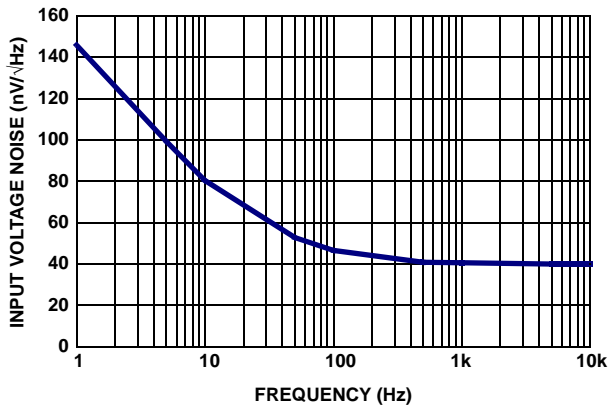

FIGURE 11. INPUT VOLTAGE NOISE vs FREQUENCY

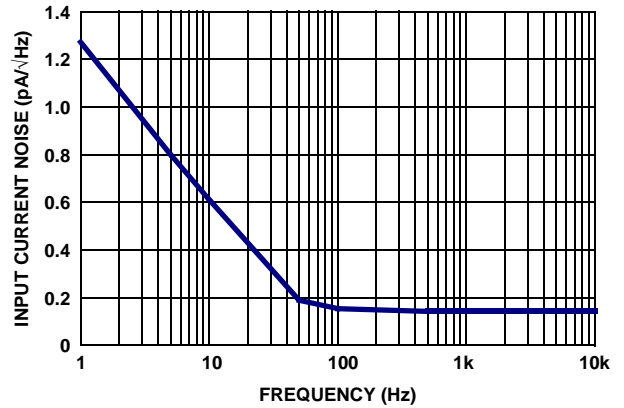

FIGURE 12. INPUT CURRENT NOISE vs FREQUENCY

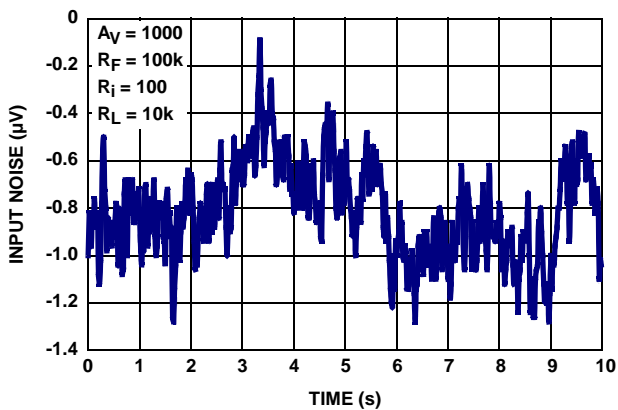

FIGURE 13. 1Hz TO 10Hz INPUT NOISE

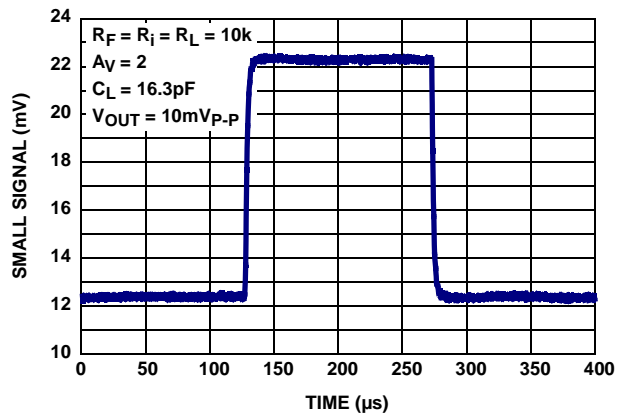

FIGURE 14. SMALL SIGNAL STEP RESPONSE

Typical Performance Curves (Continued)

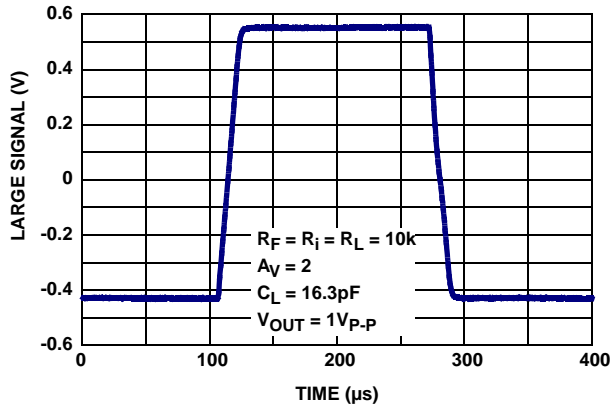

FIGURE 15. LARGE SIGNAL STEP RESPONSE

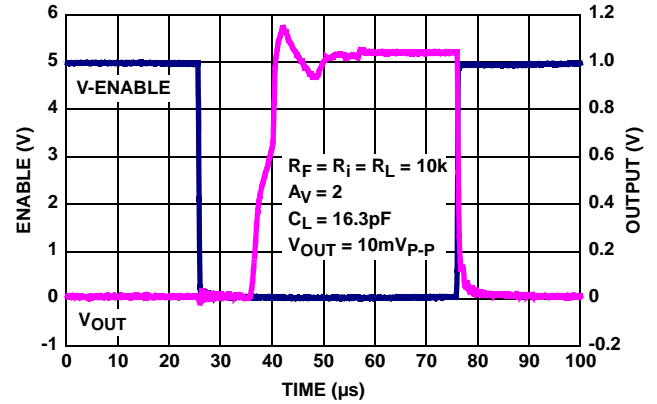

FIGURE 16. ENABLE TO OUTPUT DELAY

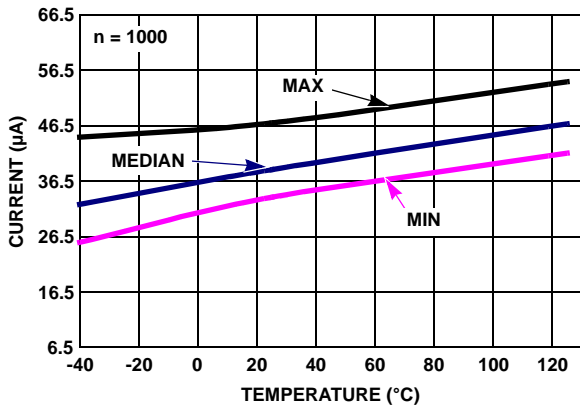

FIGURE 17. SUPPLY CURRENT ENABLED vs TEMPERATURE, $V_S = \pm 2.5V$

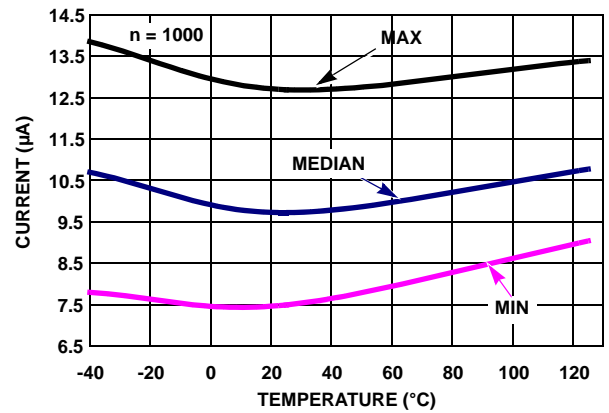

FIGURE 18. SUPPLY CURRENT DISABLED vs TEMPERATURE, $V_S = \pm 2.5V$

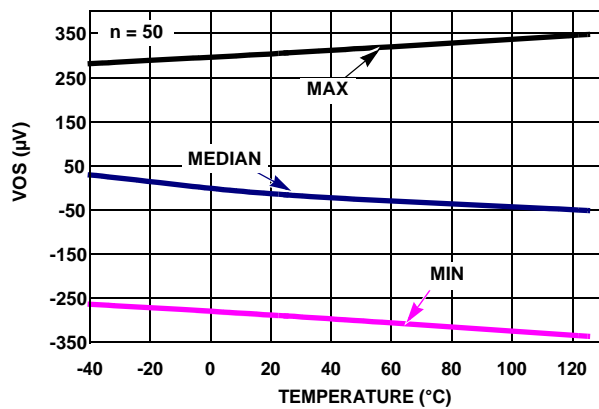

FIGURE 19. VOS vs TEMPERATURE, $V_S = \pm 2.5V$

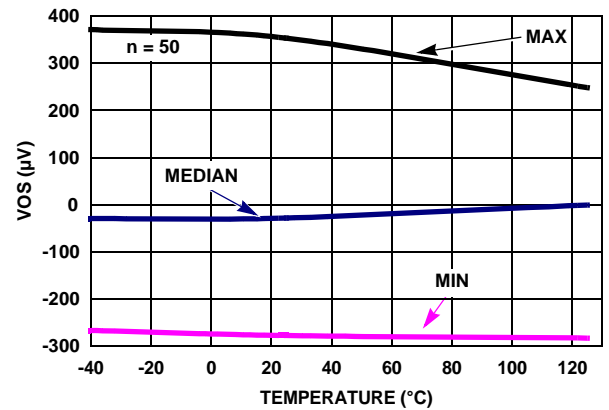

FIGURE 20. VOS vs TEMPERATURE, $V_S = \pm 1.2V$

Typical Performance Curves (Continued)

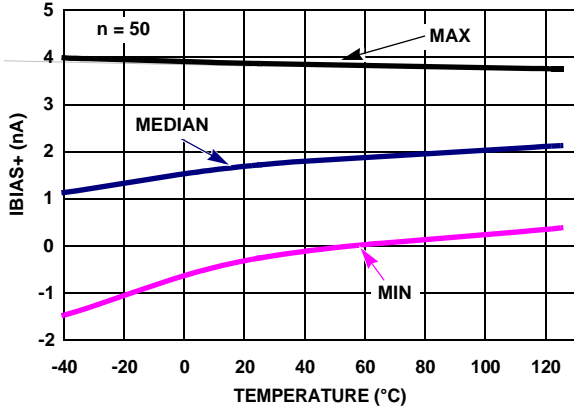

FIGURE 21. I_{BIAS+} vs TEMPERATURE, $V_S = \pm 2.5V$

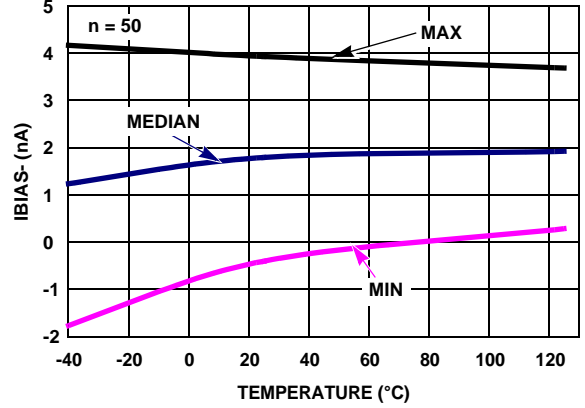

FIGURE 22. I_{BIAS-} vs TEMPERATURE, $V_S = \pm 2.5V$

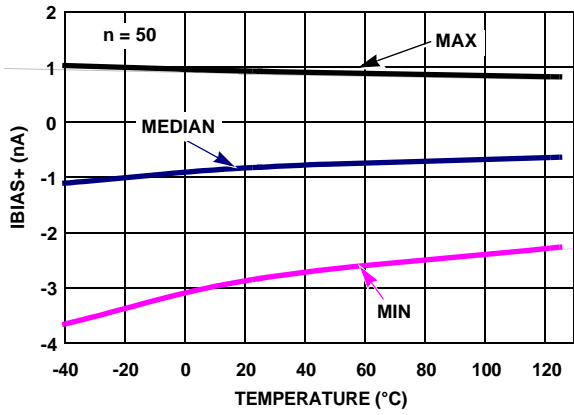

FIGURE 23. I_{BIAS+} vs TEMPERATURE, $V_S = \pm 1.2V$

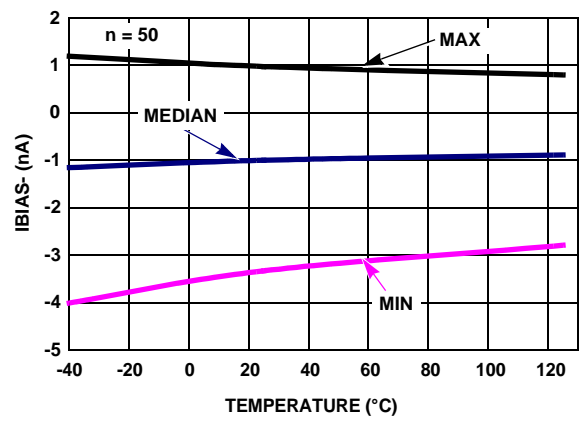

FIGURE 24. I_{BIAS-} vs TEMPERATURE, $V_S = \pm 1.2V$

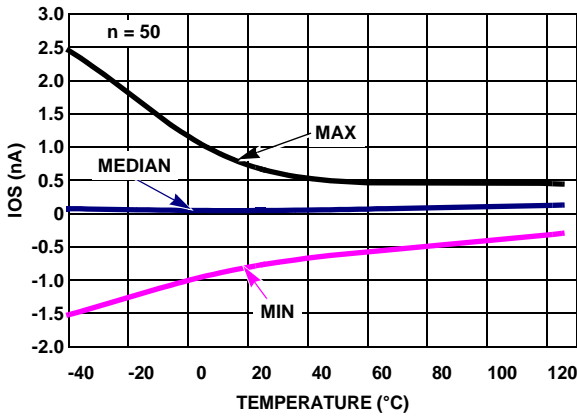

FIGURE 25. I_{OS} vs TEMPERATURE, $V_S = \pm 2.5V$

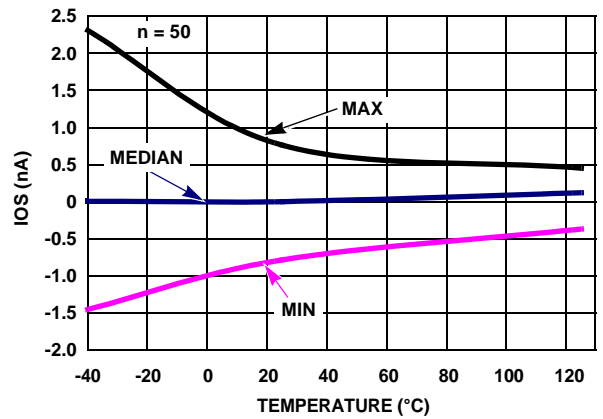

FIGURE 26. I_{OS} vs TEMPERATURE, $V_S = \pm 1.2V$

Typical Performance Curves (Continued)

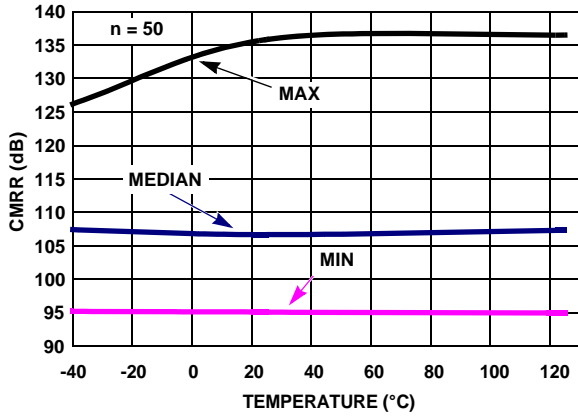

FIGURE 27. CMRR vs TEMPERATURE $V_+ = \pm 2.5V, \pm 1.5V$

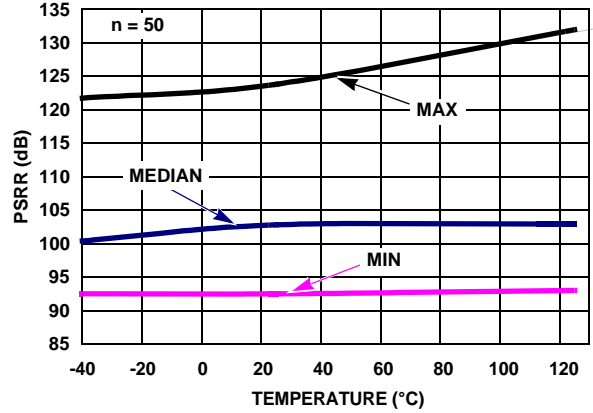

FIGURE 28. PSRR vs TEMPERATURE $\pm 1.2V$ TO $\pm 2.5V$

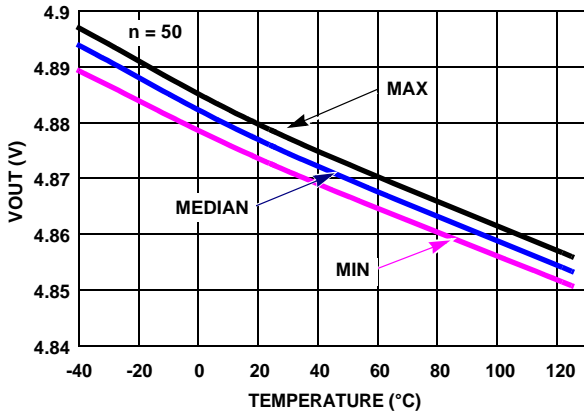

FIGURE 29. V_{OUT} HIGH vs TEMP $V_S = \pm 2.5V, R_L = 1k$

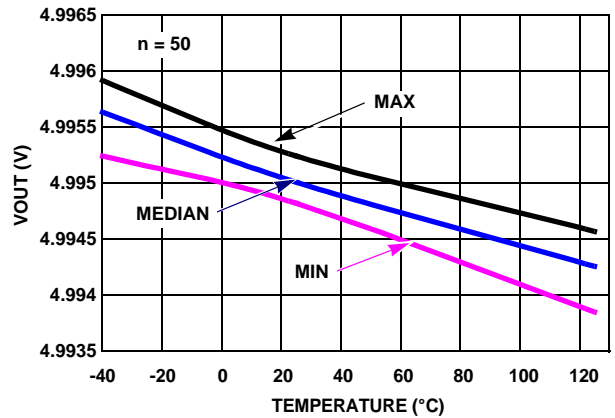

FIGURE 30. V_{OUT} HIGH $V_S = \pm 2.5V, R_L = 100k$

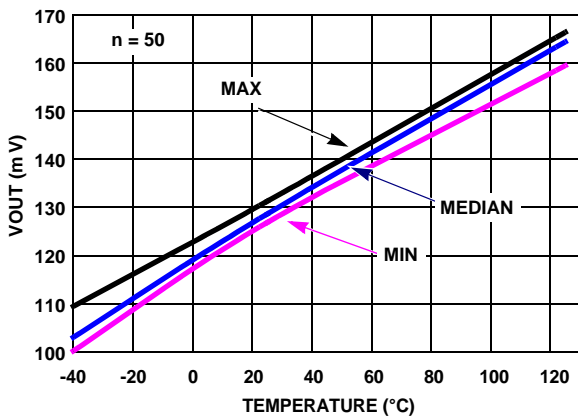

FIGURE 31. V_{OUT} LOW $V_S = \pm 2.5V, R_L = 1k$

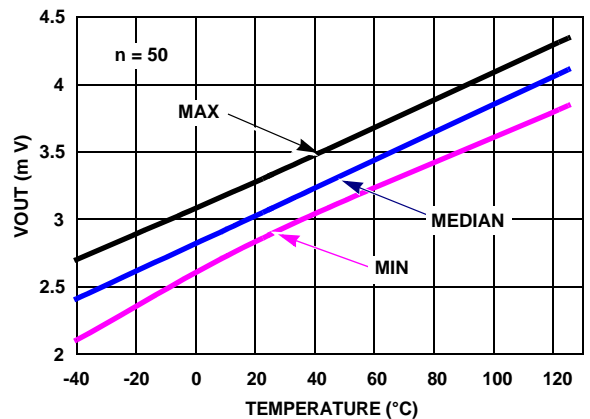

FIGURE 32. V_{OUT} LOW $V_S = \pm 2.5V, R_L = 100k$

Pin Descriptions

ISL28166 (6 Ld SOT-23)	PIN NAME	FUNCTION	EQUIVALENT CIRCUIT
4	IN-	Inverting input	<p>Circuit 1</p>
3	IN+	Non-inverting input	(See Circuit 1)
2	V-	Negative supply	
1	OUT	Output	<p>Circuit 2</p>
6	V+	Positive supply	
5	$\overline{\text{ENABLE}}$	Chip enable	<p>Circuit 3</p>

Applications Information

Introduction

The ISL28166 is a BiMOS rail-to-rail input, output (RRIO) operational amplifier with an enable feature. The device is designed to operate from single supply (2.4V to 5.0V) or dual supplies ($\pm 1.2V$ to $\pm 2.5V$) while drawing only 39 μA of supply current. This combination of low power and precision performance makes this device suitable for a variety of low power applications including battery powered systems.

Rail-to-Rail Input/Output

This device feature bi-polar input which has an input common mode range that extends to the rails and CMOS outputs that can typically swing to within about 4mV of the supply rails with a 100k Ω load. The NMOS sinks current to swing the output in the negative direction. The PMOS sources current to swing the output in the positive direction.

Input Protection

All input terminals have internal ESD protection diodes to both positive and negative supply rails, limiting the input voltage to within one diode beyond the supply rails. They also contain back-to-back diodes across the input terminals. For applications where the input differential voltage is expected to exceed 0.5V, external series resistors must be used to ensure the input currents never exceed 5mA (Figure 33).

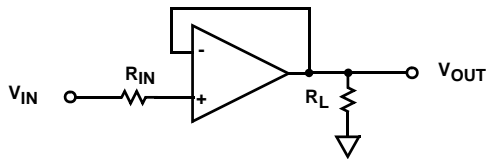

FIGURE 33. INPUT CURRENT LIMITING

Enable/Disable Feature

The ISL28166 offers an \overline{EN} pin that disables the device when pulled up to at least 2.0V. In the disabled state (output in a high impedance state), the part consumes typically 10 μA . By disabling the part, multiple ISL28166 parts can be connected together as a MUX. In this configuration, the outputs are tied together in parallel and a channel can be selected by the \overline{EN} pin. The \overline{EN} pin also has an internal pull-down. If left open, the \overline{EN} pin will pull to the negative rail and the device will be enabled by default.

The loading effects of the feedback resistors of the disabled amplifier must be considered when multiple amplifier outputs are connected together.

Current Limiting

This device has no internal current-limiting circuitry. If the output is shorted, it is possible to exceed the Absolute Maximum Rating for output current or power dissipation, potentially resulting in the destruction of the device.

Power Dissipation

It is possible to exceed the +125 $^{\circ}C$ maximum junction temperatures under certain load and power-supply conditions. It is therefore important to calculate the maximum junction temperature (T_{JMAX}) for all applications to determine if power supply voltages, load conditions, or package type need to be modified to remain in the safe operating area. These parameters are related in Equation 1:

$$T_{JMAX} = T_{MAX} + (\theta_{JA} \times PD_{MAXTOTAL}) \quad (EQ. 1)$$

where:

- $PD_{MAXTOTAL}$ is the sum of the maximum power dissipation of each amplifier in the package (PD_{MAX})
- PD_{MAX} for each amplifier can be calculated using Equation 2:

$$PD_{MAX} = 2 \times V_S \times I_{SMAX} + (V_S - V_{OUTMAX}) \times \frac{V_{OUTMAX}}{R_L} \quad (EQ. 2)$$

where:

- T_{MAX} = Maximum ambient temperature
- θ_{JA} = Thermal resistance of the package
- PD_{MAX} = Maximum power dissipation of 1 amplifier
- V_S = Supply voltage
- I_{MAX} = Maximum supply current of 1 amplifier
- V_{OUTMAX} = Maximum output voltage swing of the application
- R_L = Load resistance

All Intersil U.S. products are manufactured, assembled and tested utilizing ISO9001 quality systems. Intersil Corporation's quality certifications can be viewed at www.intersil.com/design/quality

Intersil products are sold by description only. Intersil Corporation reserves the right to make changes in circuit design, software and/or specifications at any time without notice. Accordingly, the reader is cautioned to verify that data sheets are current before placing orders. Information furnished by Intersil is believed to be accurate and reliable. However, no responsibility is assumed by Intersil or its subsidiaries for its use; nor for any infringements of patents or other rights of third parties which may result from its use. No license is granted by implication or otherwise under any patent or patent rights of Intersil or its subsidiaries.

For information regarding Intersil Corporation and its products, see www.intersil.com

Package Outline Drawing

P6.064A

6 LEAD SMALL OUTLINE TRANSISTOR PLASTIC PACKAGE

Rev 0, 2/10

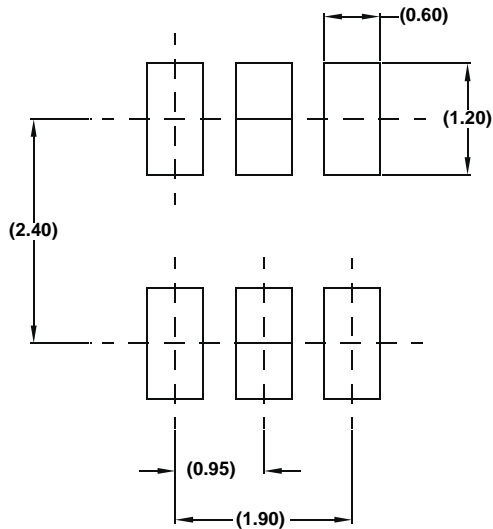
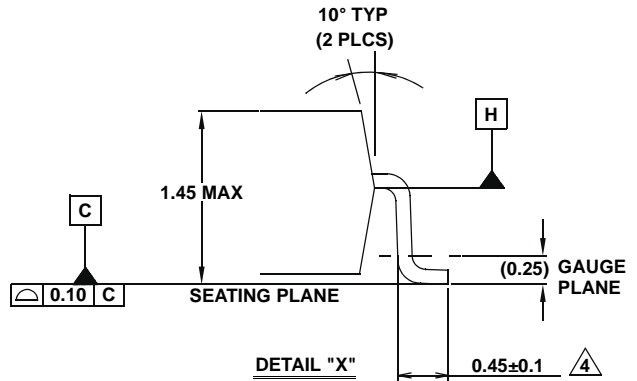
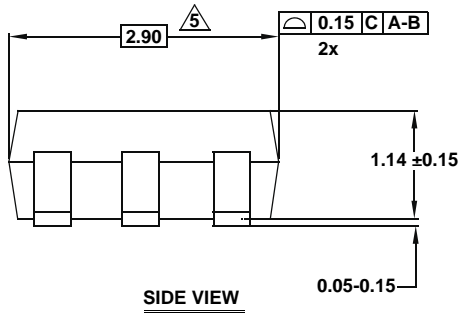
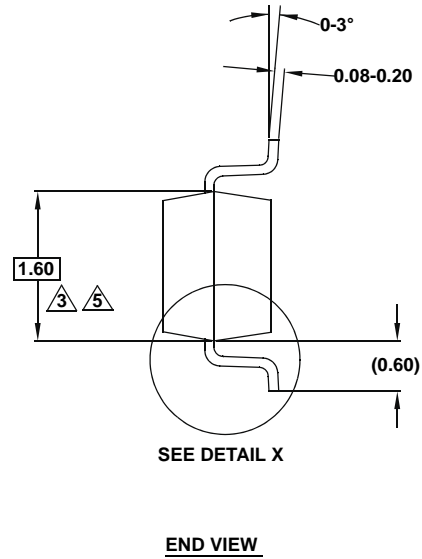
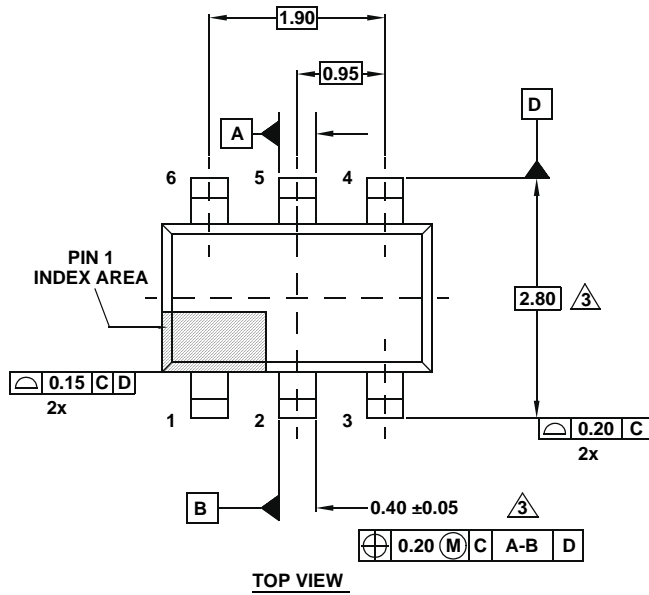

NOTES:

1. Dimensions are in millimeters.
Dimensions in () for Reference Only.
2. Dimensioning and tolerancing conform to ASME Y14.5M-1994.
3. Dimension is exclusive of mold flash, protrusions or gate burrs.
4. Foot length is measured at reference to gauge plane.
5. This dimension is measured at Datum "H".
6. Package conforms to JEDEC MO-178AA.