

# Low-Voltage CMOS Octal Buffer Flow Through Pinout With 5 V–Tolerant Inputs and Outputs (3–State, Non–Inverting)

The MC74LCX541 is a high performance, non–inverting octal buffer operating from a 2.3 to 3.6 V supply. This device is similar in function to the MC74LCX244, while providing flow through architecture. High impedance TTL compatible inputs significantly reduce current loading to input drivers while TTL compatible outputs offer improved switching noise performance. A  $V_I$  specification of 5.5 V allows MC74LCX541 inputs to be safely driven from 5 V devices. The MC74LCX541 is suitable for memory address driving and all TTL level bus oriented transceiver applications.

Current drive capability is 24 mA at the outputs. The Output Enable ( $\overline{OE1}$ ,  $\overline{OE2}$ ) inputs, when HIGH, disables the output by placing them in a HIGH Z condition.

- Designed for 2.3 to 3.6 V  $V_{CC}$  Operation
- 5 V Tolerant – Interface Capability With 5 V TTL Logic
- Supports Live Insertion and Withdrawal
- $I_{OFF}$  Specification Guarantees High Impedance When  $V_{CC} = 0$  V
- LVTTTL Compatible
- LVCMOS Compatible
- 24 mA Balanced Output Sink and Source Capability
- Near Zero Static Supply Current in All Three Logic States (10  $\mu$ A) Substantially Reduces System Power Requirements
- Latchup Performance Exceeds 500 mA
- ESD Performance: Human Body Model >2000 V; Machine Model >200 V

## MC74LCX541

# LCX

### LOW-VOLTAGE CMOS OCTAL BUFFER

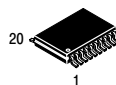

20  
1

**DT SUFFIX**  
PLASTIC TSSOP  
CASE 948E

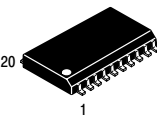

20  
1

**DW SUFFIX**  
PLASTIC SOIC  
CASE 751D

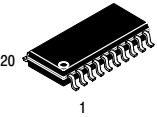

20  
1

**M SUFFIX**  
PLASTIC SOIC EIAJ  
CASE 967

**PIN NAMES**

Pins	Function
$\overline{OE}n$	Output Enable Inputs
Dn	Data Inputs
On	3–State Outputs

# MC74LCX541

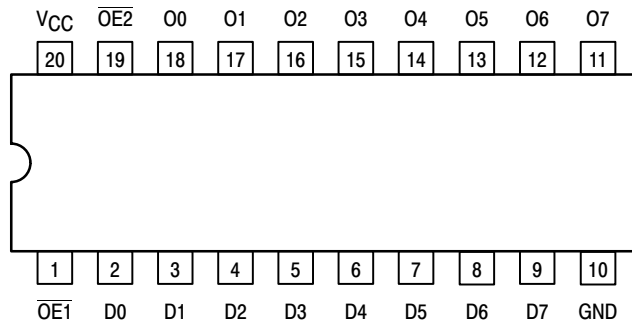

Figure 1. Pinout: 20-Lead (Top View)

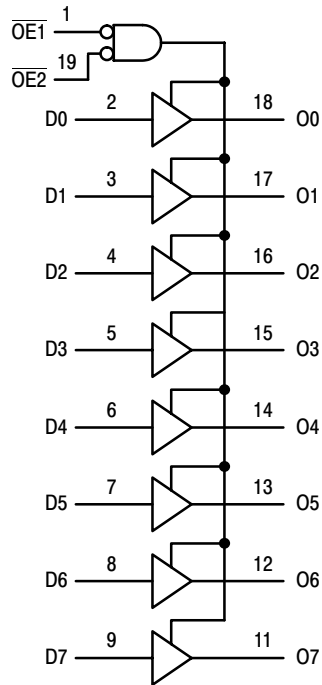

Figure 2. LOGIC DIAGRAM

INPUTS			OUTPUTS
$\overline{OE1}$	$\overline{OE2}$	Dn	On
L	L	L	L
L	L	H	H
X	H	X	Z
H	X	X	Z

H = High Voltage Level; L = Low Voltage Level; Z = High Impedance State; X = High or Low Voltage Level and Transitions are Acceptable, for I<sub>CC</sub> reasons, DO NOT FLOAT Inputs

# MC74LCX541

## MAXIMUM RATINGS

Symbol	Parameter	Value	Condition	Unit
V <sub>CC</sub>	DC Supply Voltage	-0.5 to +7.0		V
V <sub>I</sub>	DC Input Voltage	-0.5 ≤ V <sub>I</sub> ≤ +7.0		V
V <sub>O</sub>	DC Output Voltage	-0.5 ≤ V <sub>O</sub> ≤ +7.0	Output in 3-State	V
		-0.5 ≤ V <sub>O</sub> ≤ V <sub>CC</sub> + 0.5	Note 1.	V
I <sub>IK</sub>	DC Input Diode Current	-50	V <sub>I</sub> < GND	mA
I <sub>OK</sub>	DC Output Diode Current	-50	V <sub>O</sub> < GND	mA
		+50	V <sub>O</sub> > V <sub>CC</sub>	mA
I <sub>O</sub>	DC Output Source/Sink Current	±50		mA
I <sub>CC</sub>	DC Supply Current Per Supply Pin	±100		mA
I <sub>GND</sub>	DC Ground Current Per Ground Pin	±100		mA
T <sub>STG</sub>	Storage Temperature Range	-65 to +150		°C

Maximum Ratings are those values beyond which damage to the device may occur. Exposure to these conditions or conditions beyond those indicated may adversely affect device reliability. Functional operation under absolute maximum-rated conditions is not implied. Functional operation should be restricted to the Recommended Operating Conditions.

1. Output in HIGH or LOW State. I<sub>O</sub> absolute maximum rating must be observed.

## RECOMMENDED OPERATING CONDITIONS

Symbol	Parameter	Min	Typ	Max	Unit	
V <sub>CC</sub>	Supply Voltage	Operating	2.0	3.3	3.6	V
		Data Retention Only	1.5	3.3	3.6	
V <sub>I</sub>	Input Voltage	0		5.5	V	
V <sub>O</sub>	Output Voltage (HIGH or LOW State) (3-State)	0		V <sub>CC</sub>	V	
		0		5.5		
I <sub>OH</sub>	HIGH Level Output Current, V <sub>CC</sub> = 3.0 V – 3.6 V			-24	mA	
I <sub>OL</sub>	LOW Level Output Current, V <sub>CC</sub> = 3.0 V – 3.6 V			24	mA	
I <sub>OH</sub>	HIGH Level Output Current, V <sub>CC</sub> = 2.7 V – 3.0 V			-12	mA	
I <sub>OL</sub>	LOW Level Output Current, V <sub>CC</sub> = 2.7 V – 3.0 V			12	mA	
T <sub>A</sub>	Operating Free-Air Temperature	-40		+85	°C	
Δt/ΔV	Input Transition Rise or Fall Rate, V <sub>IN</sub> from 0.8 V to 2.0 V, V <sub>CC</sub> = 3.0 V	0		10	ns/V	

## DC ELECTRICAL CHARACTERISTICS

Symbol	Characteristic	Condition	T <sub>A</sub> = -40°C to +85°C		Unit
			Min	Max	
V <sub>IH</sub>	HIGH Level Input Voltage (Note 2.)	2.7 V ≤ V <sub>CC</sub> ≤ 3.6 V	2.0		V
V <sub>IL</sub>	LOW Level Input Voltage (Note 2.)	2.7 V ≤ V <sub>CC</sub> ≤ 3.6 V		0.8	V
V <sub>OH</sub>	HIGH Level Output Voltage	2.7 V ≤ V <sub>CC</sub> ≤ 3.6 V; I <sub>OH</sub> = -100 μA	V <sub>CC</sub> - 0.2		V
		V <sub>CC</sub> = 2.7 V; I <sub>OH</sub> = -12 mA	2.2		
		V <sub>CC</sub> = 3.0 V; I <sub>OH</sub> = -18 mA	2.4		
		V <sub>CC</sub> = 3.0 V; I <sub>OH</sub> = -24 mA	2.2		
V <sub>OL</sub>	LOW Level Output Voltage	2.7 V ≤ V <sub>CC</sub> ≤ 3.6 V; I <sub>OL</sub> = 100 μA		0.2	V
		V <sub>CC</sub> = 2.7 V; I <sub>OL</sub> = 12 mA		0.4	
		V <sub>CC</sub> = 3.0 V; I <sub>OL</sub> = 16 mA		0.4	
		V <sub>CC</sub> = 3.0 V; I <sub>OL</sub> = 24 mA		0.55	

2. These values of V<sub>I</sub> are used to test DC electrical characteristics only.

# MC74LCX541

## DC ELECTRICAL CHARACTERISTICS (Continued)

Symbol	Characteristic	Condition	T <sub>A</sub> = -40°C to +85°C		Unit
			Min	Max	
I <sub>I</sub>	Input Leakage Current	2.7 V ≤ V <sub>CC</sub> ≤ 3.6 V; 0 V ≤ V <sub>I</sub> ≤ 5.5 V		±5.0	μA
I <sub>OZ</sub>	3-State Output Current	2.7 ≤ V <sub>CC</sub> ≤ 3.6 V; 0 V ≤ V <sub>O</sub> ≤ 5.5 V; V <sub>I</sub> = V <sub>IH</sub> or V <sub>IL</sub>		±5.0	μA
I <sub>OFF</sub>	Power-Off Leakage Current	V <sub>CC</sub> = 0 V; V <sub>I</sub> or V <sub>O</sub> = 5.5 V		10	μA
I <sub>CC</sub>	Quiescent Supply Current	2.7 ≤ V <sub>CC</sub> ≤ 3.6 V; V <sub>I</sub> = GND or V <sub>CC</sub>		10	μA
		2.7 ≤ V <sub>CC</sub> ≤ 3.6 V; 3.6 ≤ V <sub>I</sub> or V <sub>O</sub> ≤ 5.5 V		±10	μA
ΔI <sub>CC</sub>	Increase in I <sub>CC</sub> per Input	2.7 ≤ V <sub>CC</sub> ≤ 3.6 V; V <sub>IH</sub> = V <sub>CC</sub> - 0.6 V		500	μA

## AC CHARACTERISTICS (t<sub>R</sub> = t<sub>F</sub> = 2.5 ns; C<sub>L</sub> = 50 pF; R<sub>L</sub> = 500 Ω)

Symbol	Parameter	Waveform	Limits			Unit
			T <sub>A</sub> = -40°C to +85°C			
			V <sub>CC</sub> = 3.0 V to 3.6 V		V <sub>CC</sub> = 2.7 V	
			Min	Max	Max	
t <sub>PLH</sub> t <sub>PHL</sub>	Propagation Delay Input to Output	1	1.5 1.5	6.5 6.5	7.5 7.5	ns
t <sub>PZH</sub> t <sub>PZL</sub>	Output Enable Time to High and Low Level	2	1.5 1.5	8.5 8.5	9.5 9.5	ns
t <sub>PHZ</sub> t <sub>PLZ</sub>	Output Disable Time From High and Low Level	2	1.5 1.5	7.5 7.5	8.5 8.5	ns
t <sub>OSSL</sub> t <sub>OSLH</sub>	Output-to-Output Skew (Note 3.)			1.0 1.0		ns

3. Skew is defined as the absolute value of the difference between the actual propagation delay for any two separate outputs of the same device. The specification applies to any outputs switching in the same direction, either HIGH-to-LOW (t<sub>OSSL</sub>) or LOW-to-HIGH (t<sub>OSLH</sub>); parameter guaranteed by design.

## DYNAMIC SWITCHING CHARACTERISTICS

Symbol	Characteristic	Condition	T <sub>A</sub> = +25°C			Unit
			Min	Typ	Max	
V <sub>OLP</sub>	Dynamic LOW Peak Voltage (Note 4.)	V <sub>CC</sub> = 3.3 V, C <sub>L</sub> = 50 pF, V <sub>IH</sub> = 3.3 V, V <sub>IL</sub> = 0 V		0.8		V
V <sub>OLV</sub>	Dynamic LOW Valley Voltage (Note 4.)	V <sub>CC</sub> = 3.3 V, C <sub>L</sub> = 50 pF, V <sub>IH</sub> = 3.3 V, V <sub>IL</sub> = 0 V		0.8		V

4. Number of outputs defined as "n". Measured with "n-1" outputs switching from HIGH-to-LOW or LOW-to-HIGH. The remaining output is measured in the LOW state.

## CAPACITIVE CHARACTERISTICS

Symbol	Parameter	Condition	Typical	Unit
C <sub>IN</sub>	Input Capacitance	V <sub>CC</sub> = 3.3 V, V <sub>I</sub> = 0 V or V <sub>CC</sub>	7	pF
C <sub>OUT</sub>	Output Capacitance	V <sub>CC</sub> = 3.3 V, V <sub>I</sub> = 0 V or V <sub>CC</sub>	8	pF
C <sub>PD</sub>	Power Dissipation Capacitance	10 MHz, V <sub>CC</sub> = 3.3 V, V <sub>I</sub> = 0 V or V <sub>CC</sub>	25	pF

# MC74LCX541

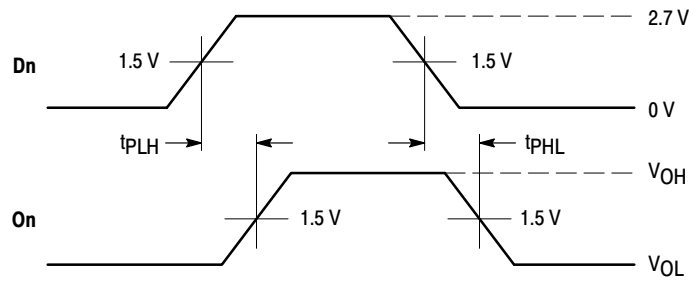

**WAVEFORM 1 - PROPAGATION DELAYS**  
 $t_R = t_F = 2.5 \text{ ns}$ , 10% to 90%;  $f = 1 \text{ MHz}$ ;  $t_W = 500 \text{ ns}$

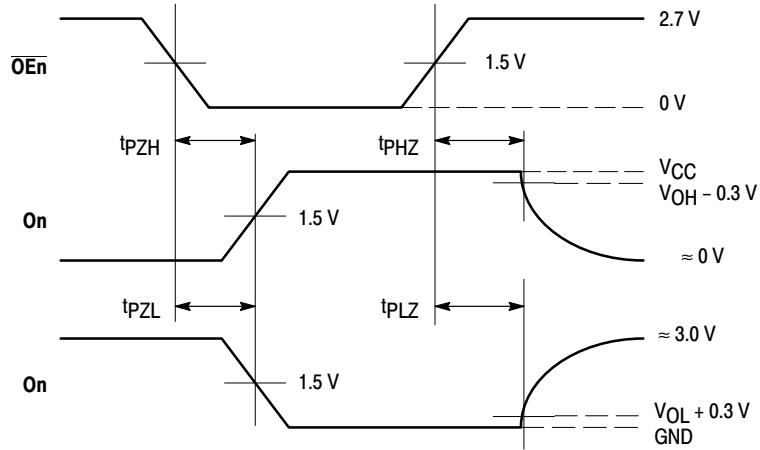

**WAVEFORM 2 - OUTPUT ENABLE AND DISABLE TIMES**  
 $t_R = t_F = 2.5 \text{ ns}$ , 10% to 90%;  $f = 1 \text{ MHz}$ ;  $t_W = 500 \text{ ns}$

**Figure 3. AC Waveforms**

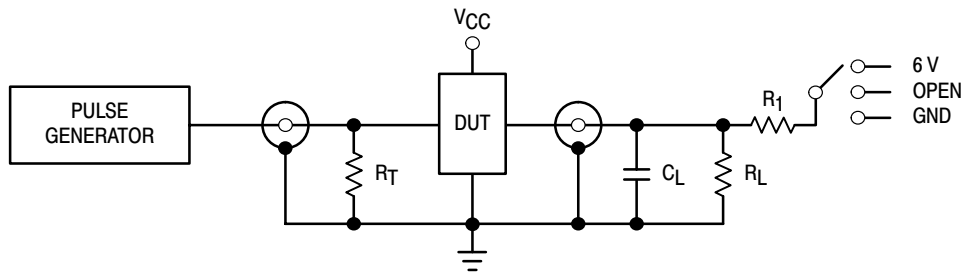

TEST	SWITCH
$t_{PLH}$ , $t_{PHL}$	Open
$t_{PZL}$ , $t_{PLZ}$	6 V
Open Collector/Drain $t_{PLH}$ and $t_{PHL}$	6 V
$t_{PZH}$ , $t_{PHZ}$	GND

$C_L = 50 \text{ pF}$  or equivalent (Includes jig and probe capacitance)  
 $R_L = R_1 = 500 \Omega$  or equivalent  
 $R_T = Z_{OUT}$  of pulse generator (typically  $50 \Omega$ )

**Figure 4. Test Circuit**