PART NUMBER**54185AJB-ROCV**

**Rochester Electronics
Manufactured Components**

Rochester branded components are manufactured using either die/wafers purchased from the original suppliers or Rochester wafers recreated from the original IP. All re-creations are done with the approval of the Original Component Manufacturer. (OCM)

Parts are tested using original factory test programs or Rochester developed test solutions to guarantee product meets or exceeds the OCM data sheet.

Quality Overview

- ISO-9001
- AS9120 certification
- Qualified Manufacturers List (QML) MIL-PRF-38535
 - Class Q Military
 - Class V Space Level

Qualified Suppliers List of Distributors (QSLD)

- Rochester is a critical supplier to DLA and meets all industry and DLA standards.

Rochester Electronics, LLC is committed to supplying products that satisfy customer expectations for quality and are equal to those originally supplied by industry manufacturers.

The original manufacturer's datasheet accompanying this document reflects the performance and specifications of the Rochester manufactured version of this device. Rochester Electronics guarantees the performance of its semiconductor products to the original OCM specifications. 'Typical' values are for reference purposes only. Certain minimum or maximum ratings may be based on product characterization, design, simulation, or sample testing.

SN54184, SN54185A, SN74184, SN74185A BCD-TO-BINARY AND BINARY-TO-BCD CONVERTERS

FEBRUARY 1971 — REVISED DECEMBER 1972

SN54184, SN74184 BCD-TO-BINARY CONVERTERS SN54185A, SN74185A BINARY-TO-BCD CONVERTERS

SN54184, SN54185A . . . J OR W PACKAGE
SN74184, SN74185A . . . J OR N PACKAGE
(TOP VIEW)

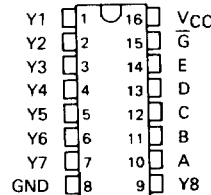

description

These monolithic converters are derived from the custom MSI 256-bit read-only memories SN5488 and SN7488. Emitter connections are made to provide direct read-out of converted codes at outputs Y8 through Y1 as shown in the function tables. These converters demonstrate the versatility of a read-only memory in that an unlimited number of reference tables or conversion tables may be built into a system using economical, customized read-only memories. Both of these converters comprehend that the least significant bits (LSB) of the binary and BCD codes are logically equal, and in each case the LSB bypasses the converter as illustrated in the typical applications. This means that a 6-bit converter is produced in each case. Both devices are cascadable to N bits.

An overriding enable input is provided on each converter which, when taken high, inhibits the function, causing all outputs to go high. For this reason, and to minimize power consumption, unused outputs Y7 and Y8 of the '185A and all "don't care" conditions of the '184 are programmed high. The outputs are of the open-collector type.

The SN54184 and SN54185A are characterized for operation over the full military temperature range of -55°C to 125°C ; the SN74184 and SN74185A are characterized for operation from 0°C to 70°C .

SN54184 and SN74184 BCD-to-binary converters

The 6-bit BCD-to-binary function of the SN54184 and SN74184 is analogous to the algorithm:

- a. Shift BCD number right one bit and examine each decade. Subtract three from each 4-bit decade containing a binary value greater than seven.
- b. Shift right, examine, and correct after each shift until the least significant decade contains a number smaller than eight and all other converted decades contain zeros.

TABLE I
SN54184, SN74184
PACKAGE COUNT AND DELAY TIMES
FOR BCD-TO-BINARY CONVERSION

INPUT (DECADES)	PACKAGES REQUIRED	TOTAL DELAY TIMES (ns)	
		TYP	MAX
2	2	56	80
3	6	140	200
4	11	196	280
5	19	280	400
6	28	364	520

In addition to BCD-to-binary conversion, the SN54184 and SN74184 are programmed to generate BCD 9's complement or BCD 10's complement. Again, in each case, one bit of the complement code is logically equal to one of the BCD bits; therefore, these complements can be produced on three lines. As outputs Y6, Y7, and Y8 are not required in the BCD-to-binary conversion, they are utilized to provide these complement codes as specified in the function table (following page, right) when the devices are connected as shown above the function table.

5

RAMS

SN54184, SN74184 BCD-TO-BINARY AND BINARY-TO-BCD CONVERTERS

SN54184 and SN74184 BCD-to-binary converters (continued)

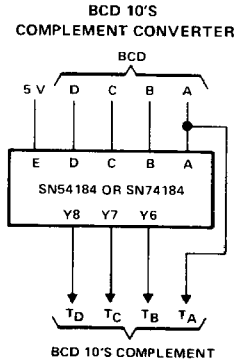
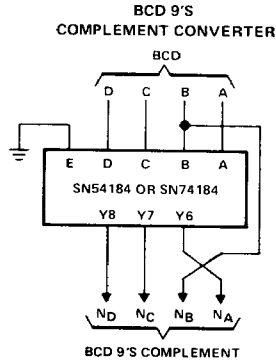
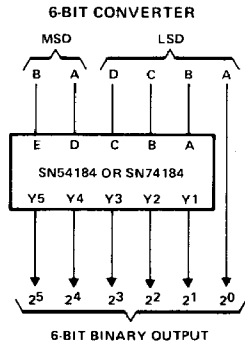

FUNCTION TABLE
BCD-TO-BINARY
CONVERTER

BCD WORDS	INPUTS (See Note A)						OUTPUTS (See Note B)				
	E	D	C	B	A	\bar{G}	Y5	Y4	Y3	Y2	Y1
0 1	L	L	L	L	L	L	L	L	L	L	L
2 3	L	L	L	L	H	L	L	L	L	H	H
4 5	L	L	L	H	L	L	L	L	H	L	L
6 7	L	L	L	H	H	L	L	L	L	H	H
8 9	L	L	H	L	L	L	L	L	H	L	L
10 11	L	H	L	L	L	L	L	L	H	L	H
12 13	L	H	L	H	L	L	L	L	H	H	L
14 15	L	H	L	H	H	L	L	L	H	H	H
16 17	L	H	H	L	H	L	L	H	L	L	L
18 19	L	H	H	L	L	L	L	L	H	L	L
20 21	H	L	L	L	L	L	L	L	H	L	H
22 23	H	L	L	L	H	L	L	L	H	L	H
24 25	H	L	L	H	L	L	L	H	H	L	L
26 27	H	L	L	H	H	L	L	H	H	L	H
28 29	H	L	H	L	L	L	L	L	H	H	L
30 31	H	H	L	L	L	L	L	L	H	H	H
32 33	H	H	L	L	H	L	L	L	L	L	L
34 35	H	H	L	H	L	L	L	L	L	L	H
36 37	H	H	L	H	H	L	L	L	L	H	L
38 39	H	H	H	L	L	L	L	L	L	H	H
ANY	X	X	X	X	X	H	H	H	H	H	H

H = high level, L = low level, X = irrelevant

NOTES: A. Input conditions other than those shown produce highs at outputs Y1 through Y5.

B. Outputs Y6, Y7, and Y8 are not used for BCD-to-binary conversion.

FUNCTION TABLE
BCD 9'S OR BCD 10'S
COMPLEMENT CONVERTER

BCD WORD	INPUTS (See Note C)						OUTPUTS (See Note D)			
	E [†]	D	C	B	A	\bar{G}	Y8	Y7	Y6	
0	L	L	L	L	L	L	L	H	L	H
1	L	L	L	L	H	L	L	H	L	L
2	L	L	L	H	L	L	L	L	H	H
3	L	L	L	H	H	L	L	L	H	L
4	L	L	H	L	L	L	L	L	H	H
5	L	L	H	L	H	L	L	L	H	L
6	L	L	H	H	L	L	L	L	L	H
7	L	L	H	H	H	L	L	L	L	L
8	L	H	L	L	L	L	L	L	L	H
9	L	H	L	L	H	L	L	L	L	L
0	H	L	L	L	L	L	L	L	L	L
1	H	L	L	L	H	L	L	H	L	L
2	H	L	L	H	L	L	L	H	L	L
3	H	L	L	H	H	L	L	L	H	H
4	H	L	H	L	L	L	L	L	H	H
5	H	L	H	L	H	L	L	L	H	L
6	H	L	H	H	L	L	L	L	H	L
7	H	L	H	H	H	L	L	L	L	H
8	H	H	L	L	L	L	L	L	L	H
9	H	H	L	L	H	L	L	L	L	L
ANY	X	X	X	X	X	H	H	H	H	H

H = high level, L = low level, X = irrelevant

NOTES: C. Input conditions other than those shown produce highs at outputs Y6, Y7, and Y8.

D. Outputs Y1 through Y5 are not used for BCD 9's or BCD 10's complement conversion.

[†]When these devices are used as complement converters, input E is used as a mode control. With this input low, the BCD 9's complement is generated; when it is high, the BCD 10's complement is generated.

5

RAMS

SN54185A, SN74185A BCD-TO-BINARY AND BINARY-TO-BCD CONVERTERS

SN54185A and SN74185A binary-to-BCD converters

The function performed by these 6-bit binary-to-BCD converters is analogous to the algorithm:

- a. Examine the three most significant bits. If the sum is greater than four, add three and shift left one bit.
- b. Examine each BCD decade. If the sum is greater than four, add three and shift left one bit.
- c. Repeat step b until the least-significant binary bit is in the least-significant BCD location.

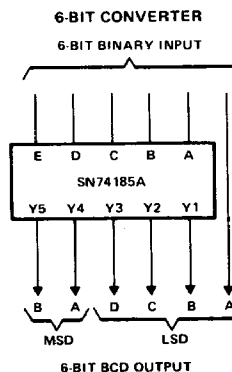

TABLE II
SN54185A, SN74185A
PACKAGE COUNT AND DELAY TIMES
FOR BINARY-TO-BCD CONVERSION

INPUT (BITS)	PACKAGES REQUIRED	TOTAL DELAY TIME (ns)	
		TYP	MAX
4 to 6	1	25	40
7 or 8	3	50	80
9	4	75	120
10	6	100	160
11	7	125	200
12	8	125	200
13	10	150	240
14	12	175	280
15	14	175	280
16	16	200	320
17	19	225	360
18	21	225	360
19	24	250	400
20	27	275	440

FUNCTION TABLE

BINARY WORDS	INPUTS					ENABLE \bar{G}	OUTPUTS							
	BINARY SELECT E	D	C	B	A		Y8	Y7	Y6	Y5	Y4	Y3	Y2	Y1
0 1	L	L	L	L	L	L	H	H	L	L	L	L	L	L
2 3	L	L	L	L	H	L	H	H	L	L	L	L	L	H
4 5	L	L	L	H	L	L	H	H	L	L	L	L	H	L
6 7	L	L	L	H	H	L	H	H	L	L	L	L	H	H
8 9	L	L	H	L	L	L	H	H	L	L	L	H	L	L
10 11	L	L	H	L	H	L	H	H	L	L	H	L	L	L
12 13	L	L	H	H	L	L	H	H	L	L	H	L	L	H
14 15	L	L	H	H	H	L	H	H	L	L	H	L	H	L
16 17	L	H	L	L	L	L	H	H	L	L	H	L	H	H
18 19	L	H	L	L	H	L	H	H	L	L	H	H	L	L
20 21	L	H	L	H	L	L	H	H	L	H	L	L	L	L
22 23	L	H	L	H	H	L	H	H	L	H	L	L	L	H
24 25	L	H	H	L	L	L	H	H	L	H	L	L	H	L
26 27	L	H	H	L	H	L	H	H	L	H	L	L	H	H
28 29	L	H	H	H	L	L	H	H	L	H	L	H	L	L
30 31	L	H	H	H	H	L	H	H	L	H	H	L	L	L
32 33	H	L	L	L	L	L	H	H	L	H	H	L	L	H
34 35	H	L	L	L	H	L	H	H	L	H	H	L	H	L
36 37	H	L	L	H	L	L	H	H	L	H	H	L	H	H
38 39	H	L	L	H	H	L	H	H	L	H	H	L	H	L
40 41	H	L	H	L	L	L	H	H	H	L	L	L	L	L
42 43	H	L	H	L	H	L	H	H	H	L	L	L	L	H
44 45	H	L	H	H	L	L	H	H	H	L	L	L	H	L
46 47	H	L	H	H	H	L	H	H	H	L	L	L	H	H
48 49	H	H	L	L	L	L	H	H	H	L	L	H	L	L
50 51	H	H	L	L	H	L	H	H	H	L	H	L	L	L
52 53	H	H	L	H	L	L	H	H	H	L	H	L	L	H
54 55	H	H	L	H	H	L	H	H	H	L	H	L	L	H
56 57	H	H	H	L	L	L	H	H	H	L	H	L	H	H
58 59	H	H	H	L	H	L	H	H	H	L	H	H	L	L
60 61	H	H	H	H	L	L	H	H	H	L	L	L	L	L
62 63	H	H	H	H	H	L	H	H	H	L	L	L	L	H
ALL	X	X	X	X	X	H	H	H	H	H	H	H	H	H

H = high level, L = low level, X = irrelevant



RAMS

SN54184, SN54185A, SN74184, SN74185A BCD-TO-BINARY AND BINARY-TO-BCD CONVERTERS

absolute maximum ratings over operating free-air temperature range (unless otherwise noted)

Supply voltage, V_{CC} (see Note 1)	7 V
Input voltage	5.5 V
Operating free-air temperature range: SN54184, SN54185A	-55°C to 125°C
SN74184, SN74185A	0°C to 70°C
Storage temperature range	-65°C to 150°C

NOTE 1: Voltage values are with respect to network ground terminal.

recommended operating conditions

	SN54184, SN54185A			SN74184, SN74185A			UNIT
	MIN	NOM	MAX	MIN	NOM	MAX	
Supply voltage, V_{CC}	4.5	5	5.5	4.75	5	5.25	V
Low-level output current, I_{OL}			12			12	mA
Operating free-air temperature, T_A	-55		125	0		70	°C

electrical characteristics over recommended operating free-air temperature range (unless otherwise noted)

PARAMETER	TEST CONDITIONS [†]	MIN	TYP [‡]	MAX	UNIT
V_{IH} High-level input voltage		2			V
V_{IL} Low-level input voltage				0.8	V
V_{IK} Input clamp voltage	$V_{CC} = \text{MIN}$, $I_I = -12 \text{ mA}$			-1.5	V
I_{OH} High-level output current	$V_{CC} = \text{MIN}$, $V_{IH} = 2 \text{ V}$, $V_{IL} = 0.8 \text{ V}$, $V_{OH} = 5.5 \text{ V}$			100	μA
V_{OL} Low-level output voltage	$V_{CC} = \text{MIN}$, $V_{IH} = 2 \text{ V}$, $V_{IL} = 0.8 \text{ V}$, $I_{OL} = 12 \text{ mA}$			0.4	V
I_I Input current at maximum input voltage	$V_{CC} = \text{MAX}$, $V_I = 5.5 \text{ V}$			1	mA
I_{IH} High-level input current	$V_{CC} = \text{MAX}$, $V_I = 2.4 \text{ V}$			40	μA
I_{IL} Low-level input current	$V_{CC} = \text{MAX}$, $V_I = 0.4 \text{ V}$			-1	mA
I_{CCH} Supply current, all outputs high	$V_{CC} = \text{MAX}$		50		mA
I_{CCL} Supply current, all programmed outputs low			62	99	

[†]For conditions shown as MIN or MAX, use the appropriate value specified under recommended operating conditions for the applicable type.

[‡]All typical values are at $V_{CC} = 5 \text{ V}$, $T_A = 25^\circ\text{C}$.

switching characteristics, $V_{CC} = 5 \text{ V}$, $T_A = 25^\circ\text{C}$

PARAMETER	TEST CONDITIONS	MIN	TYP	MAX	UNIT
t_{PLH} Propagation delay time, low-to-high-level output from enable \bar{G}	$C_L = 30 \text{ pF}$, $R_{L1} = 300 \Omega$,		19	30	ns
t_{PHL} Propagation delay time, high-to-low-level output from enable \bar{G}			22	35	
t_{PLH} Propagation delay time, low-to-high-level output from binary select	$R_{L2} = 600 \Omega$, See Figure 1 and Note 2		27	40	ns
t_{PHL} Propagation delay time, high-to-low-level output from binary select			23	40	

9

RAMS

SN54184, SN54185A, SN74184, SN74185A BCD-TO-BINARY AND BINARY-TO-BCD CONVERTERS

schematics of inputs and outputs

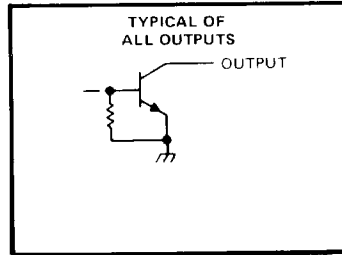
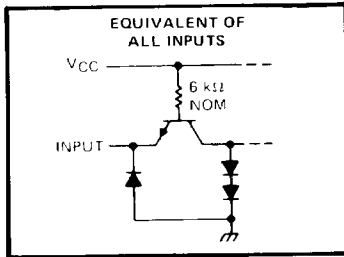

PARAMETER MEASUREMENT INFORMATION

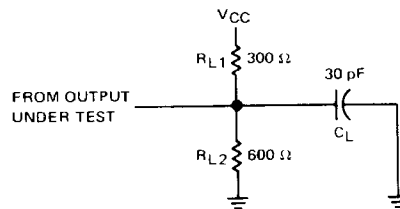

C_L includes probe and jig capacitance.

LOAD CIRCUIT
FIGURE 1

NOTE 2: See General Information Section for load circuits and voltage waveforms.

5

RAMS

SN54184, SN74184 BCD-TO-BINARY CONVERTERS

TYPICAL APPLICATION DATA SN54184, SN74184

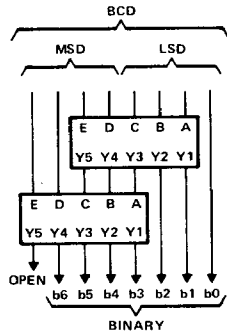

FIGURE 2—BCD-TO-BINARY CONVERTER
FOR TWO BCD DECADES

MSD—most significant decade
LSD—least significant decade
Each rectangle represents an SN54184 or SN74184

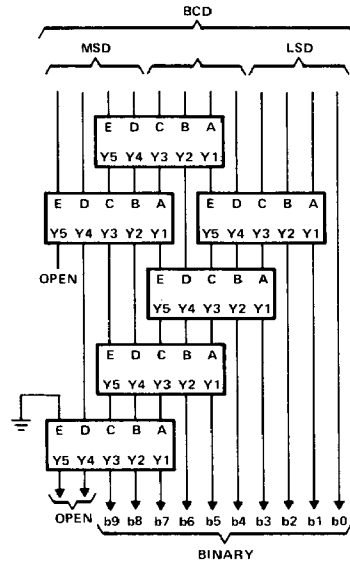
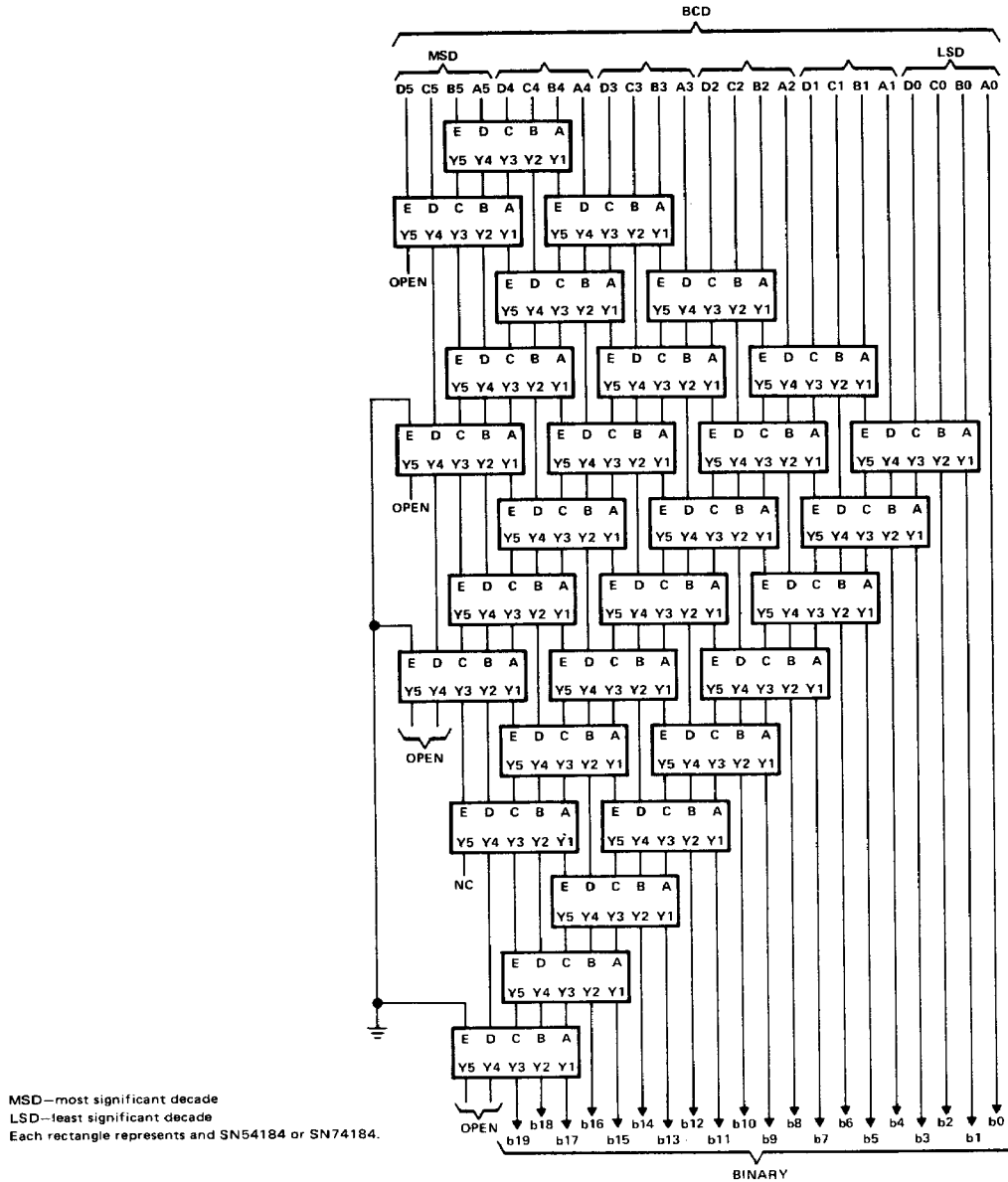

FIGURE 3—BCD-TO-BINARY CONVERTER
FOR THREE BCD DECADES

5

RAMS

TYPICAL APPLICATION DATA
SN54184, SN74184



5

RAMS

FIGURE 4—BCD-TO-BINARY CONVERTER FOR SIX BCD DECADES

SN54185A, SN74185A
BINARY-TO-BCD CONVERTERS

TYPICAL APPLICATION DATA
SN54185A, SN74185A

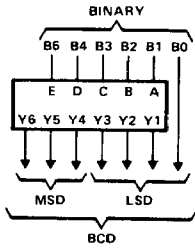

FIGURE 5—6-BIT BINARY-TO-BCD CONVERTER

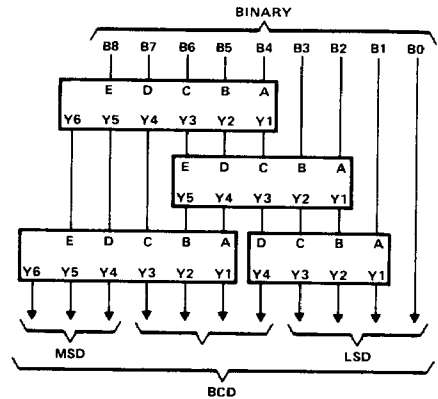

FIGURE 7—9-BIT BINARY-TO-BCD CONVERTER

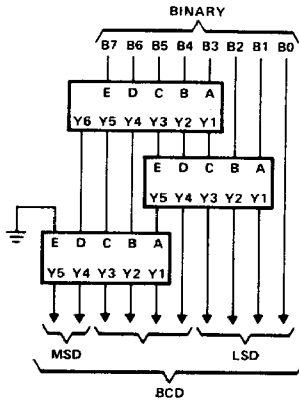

FIGURE 6—8-BIT BINARY-TO-BCD CONVERTER

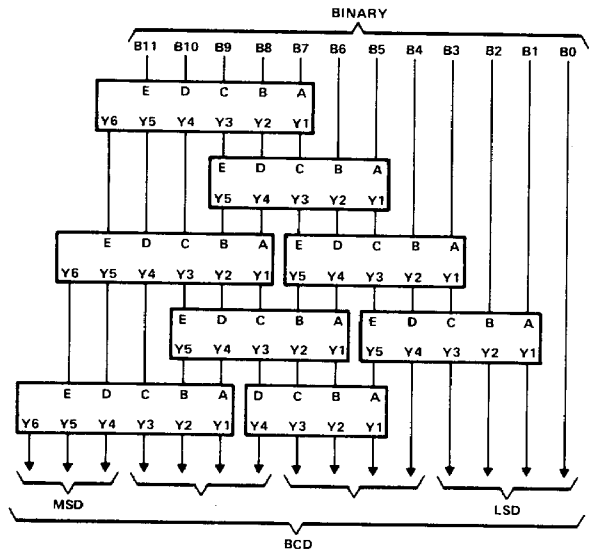

FIGURE 8—12-BIT BINARY-TO-BCD CONVERTER (SEE NOTE B)

MSD—Most significant decade
 LSD—Least significant decade

NOTES: A. Each rectangle represents an SN54185A or an SN74185A.
 B. All unused E inputs are grounded.



RAMS

**SN54185A, SN74185A
BINARY-TO-BCD CONVERTERS**

**TYPICAL APPLICATION DATA
SN54185A, SN74185A**

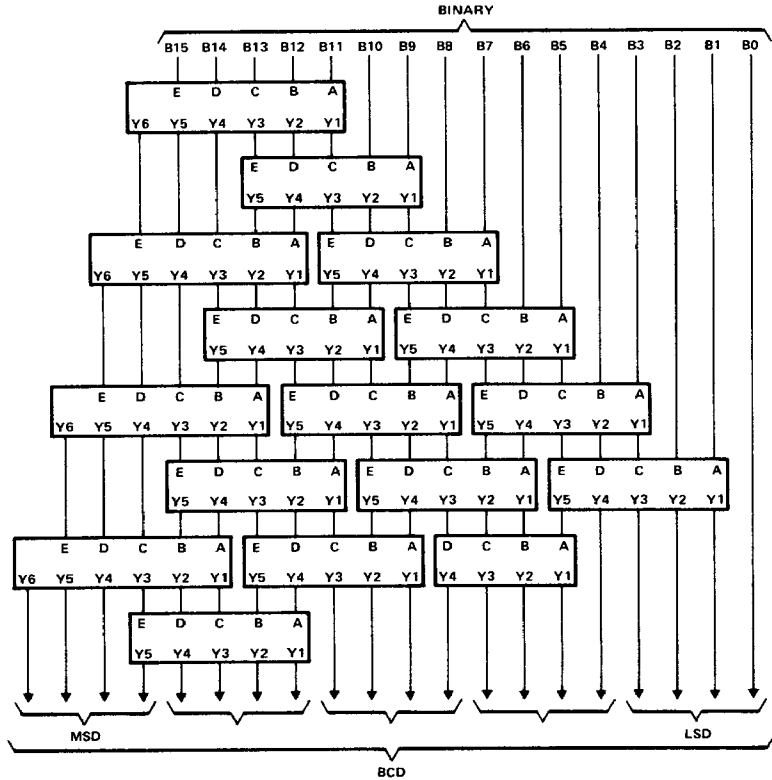

**FIGURE 9-16 BIT BINARY-TO-BCD
CONVERTER (SEE NOTE B)**

MSD--most significant decade
 LSD--least significant decade
 NOTES: A. Each rectangle represents an SN54185A or SN74185A.
 B. All unused E inputs are grounded.

**5
RAMS**