

# LT1001 PRECISION OPERATIONAL AMPLIFIER

D3192, JANUARY 1989

- **Low Input Offset Voltage:**  
 LT1001AM ... 15  $\mu\text{V}$  Max  
 LT1001AC ... 25  $\mu\text{V}$  Max  
 LT1001M, LT1001C ... 60  $\mu\text{V}$  Max
- **Low Offset Voltage Temperature Coefficient:**  
 LT1001AM, LT1001AC ... 0.6  $\mu\text{V}/^\circ\text{C}$  Max  
 LT1001M, LT1001C ... 1  $\mu\text{V}/^\circ\text{C}$  Max
- **Low Input Bias Current:**  
 LT1001AM, LT1001AC ...  $\pm 2$  nA Max  
 LT1001M, LT1001C ...  $\pm 4$  nA Max
- **Low Common-Mode Rejection Ratio:**  
 LT1001AM, LT1001AC ... 114 dB Min  
 LT1001M, LT1001C ... 110 dB Min
- **Low Supply Voltage Rejection Ratio:**  
 LT1001AM, LT1001AC ... 110 dB Min  
 LT1001M, LT1001C ... 106 dB Min
- **Low Power Dissipation:**  
 LT1001AM, LT1001AC ... 75 mW Max  
 LT1001M, LT1001C ... 80 mW Max
- **Low Peak-to-Peak Equivalent Input Noise Voltage ... 0.3  $\mu\text{V}$  Typ**

D, JG, OR P PACKAGE  
(TOP VIEW)

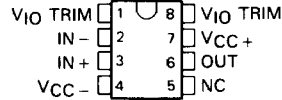

L PACKAGE  
(TOP VIEW)

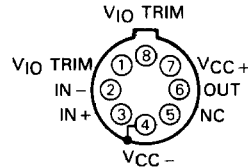

NC—No internal connection  
 Pin 4 (L package) is in electrical contact with the case.

## description

The LT1001 is a precision operational amplifier suited for applications such as thermocouple amplifiers, strain gauge amplifiers, low-level signal processing, and high-accuracy data acquisition. In the design, processing, and testing of the device, particular attention has been paid to optimizing the entire distribution of several key parameters. The input offset voltage of all units is less than 60  $\mu\text{V}$ , and the LT1001AM is specified at 15  $\mu\text{V}$  maximum. Power dissipation is nearly halved compared to the most popular precision operational amplifiers without adversely affecting noise or speed performance. The output drive capability of the LT1001 is enhanced with voltage gain at a load current of 10 mA.

The specifications of the low-cost commercial-temperature device, the LT1001C, have been significantly improved when compared to equivalent grades of similar precision amplifiers. The input bias current, input offset current, and common-mode and supply voltage rejection ratios of the LT1001C offer performance previously attainable only with high-cost, selected grades of other devices.

The M-suffix devices are characterized for operation over the full military temperature range of  $-55^\circ\text{C}$  to  $125^\circ\text{C}$ . The C-suffix devices are characterized for operation from  $0^\circ\text{C}$  to  $70^\circ\text{C}$ .

### AVAILABLE OPTIONS

T <sub>A</sub>	V <sub>IO</sub> MAX	PACKAGE			
		SMALL OUTLINE (D)	CERAMIC DIP (JG)	METAL CAN (L)	PLASTIC DIP (P)
0°C	60 $\mu\text{V}$	LT1001CD	LT1001CJG	LT1001CL	LT1001CP
to 70°C	25 $\mu\text{V}$		LT1001ACJG	LT1001ACL	LT1001ACP
$-55^\circ\text{C}$	60 $\mu\text{V}$		LT1001MJG	LT1001ML	
to 125°C	15 $\mu\text{V}$		LT1001AMJG	LT1001AML	

The D package is available in tape and reel. Add the suffix R to the device type (e.g., LT1001CDR).

**PRODUCTION DATA** documents contain information current as of publication date. Products conform to specifications per the terms of Texas Instruments standard warranty. Production processing does not necessarily include testing of all parameters.

**TEXAS  
INSTRUMENTS**

POST OFFICE BOX 655012 • DALLAS, TEXAS 75265

Copyright © 1989, Texas Instruments Incorporated

2

Operational Amplifiers

# LT1001 PRECISION OPERATIONAL AMPLIFIER

schematic

## 2 Operational Amplifiers

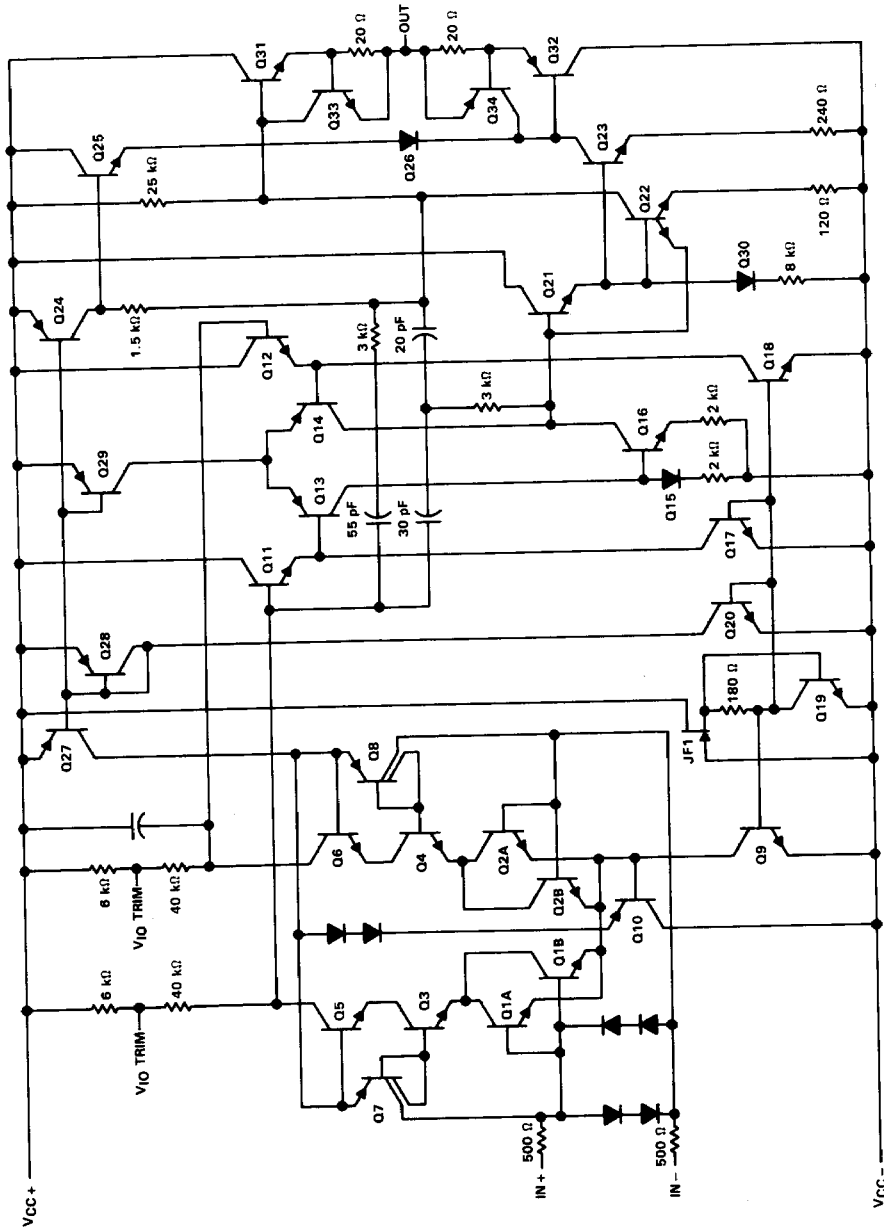

Component values shown are nominal.

**absolute maximum ratings over operating free-air temperature range (unless otherwise noted)**

Supply voltage, $V_{CC+}$ (see Note 1)	22 V
Supply voltage, $V_{CC-}$	-22 V
Differential input voltage (see Note 2)	$\pm 30$ V
Input voltage range, $V_I$	$\pm 22$ V
Duration of short-circuit current at (or below) 25°C	unlimited
Continuous power dissipation	See Dissipation Rating Table
Operating free-air temperature range: M-suffix	-55°C to 125°C
C-suffix	0°C to 70°C
Storage temperature range	-65°C to 150°C
Lead temperature 1,6 mm (1/16 inch) from case for 60 seconds: JG or L package	300°C
Lead temperature 1,6 mm (1/16 inch) from case for 10 seconds: D or P package	260°C

NOTES: 1. All voltage values, except differential voltages, are with respect to the midpoint between  $V_{CC+}$  and  $V_{CC-}$ .  
2. Differential voltages are at the noninverting input with respect to the inverting input.

**DISSIPATION RATING TABLE**

PACKAGE	$T_A \leq 25^\circ\text{C}$	DERATING FACTOR	$T_A = 70^\circ\text{C}$	$T_A = 125^\circ\text{C}$
	POWER RATING	ABOVE $T_A = 25^\circ\text{C}$	POWER RATING	POWER RATING
D	725 mW	5.8 mW/°C	464 mW	145 mW
JG (M-suffix)	1050 mW	8.4 mW/°C	672 mW	210 mW
JG (C-suffix)	825 mW	6.6 mW/°C	528 mW	N/A
L (M-suffix)	825 mW	6.6 mW/°C	528 mW	165 mW
L (C-suffix)	650 mW	5.2 mW/°C	416 mW	N/A
P	1000 mW	8.0 mW/°C	640 mW	200 mW

**recommended operating conditions**

	M-SUFFIX			C-SUFFIX			UNIT
	MIN	NOM	MAX	MIN	NOM	MAX	
Supply voltage, $V_{CC+}$	4	15	22	4	15	22	V
Supply voltage, $V_{CC-}$	-4	-15	-22	-4	-15	-22	V
Common-mode input voltage, $V_{IC}$	$V_{CC\pm} \pm 15$ V			$\pm 13$			V
Operating free-air temperature, $T_A$	-55			125			0 70 °C

**2**  
**Operational Amplifiers**

# LT1001M, LT1001AM PRECISION OPERATIONAL AMPLIFIERS

electrical characteristics,  $V_{CC\pm} = \pm 15\text{ V}$  (unless otherwise noted)

PARAMETER	TEST CONDITIONS	$T_A$	LT1001M			LT1001AM			UNIT
			MIN	TYP	MAX	MIN	TYP	MAX	
$V_{IO}$ Input offset voltage	See Note 3	25°C		18	60		7	15	$\mu\text{V}$
		-55°C to 125°C			160			60	
$\alpha_{VIO}$ Average temperature coefficient of input offset voltage		-55°C to 125°C		0.3	1		0.2	0.6	$\mu\text{V}/^\circ\text{C}$
Long-term drift of input offset voltage	See Note 4			0.3	1.5		0.2	1	$\mu\text{V}/\text{mo}$
$I_{IO}$ Input offset current	$V_O = 0, V_{IC} = 0$	25°C		0.4	3.8		0.3	2	nA
		-55°C to 125°C			7.6			4	
$I_{IB}$ Input bias current	$V_O = 0, V_{IC} = 0$	25°C		$\pm 0.7$	$\pm 4$		$\pm 0.5$	$\pm 2$	nA
		-55°C to 125°C			$\pm 8$			$\pm 4$	
$V_{OH}$ Maximum peak output voltage swing	$R_L \geq 2\text{ k}\Omega$	25°C		$\pm 13$	$\pm 14$		$\pm 13$	$\pm 14$	V
	$R_L \geq 1\text{ k}\Omega$			$\pm 12$	$\pm 13.5$		$\pm 12$	$\pm 13.5$	
$A_{VD}$ Large-signal differential voltage amplification	$R_L \geq 2\text{ k}\Omega, V_O = \pm 12\text{ V}$	25°C		400	800		450	800	V/mV
	$R_L \geq 1\text{ k}\Omega, V_O = \pm 10\text{ V}$			250	500		300	500	
	$R_L \geq 2\text{ k}\Omega, V_O = \pm 10\text{ V}$		-55°C to 125°C	200			300		
$r_{id}$ Differential input resistance		25°C	15	80		30	100	M $\Omega$	
CMRR Common-mode rejection ratio	$V_{IC} = \pm 13\text{ V}$	25°C		110	126		114	126	dB
		-55°C to 125°C		106			110		
KSVR Supply voltage rejection ratio	$V_{CC\pm} = \pm 3\text{ V to } \pm 18\text{ V}$	25°C		106	123		110	123	dB
		-55°C to 125°C		100			104		
$P_D$ Total power dissipation	No load	25°C		48	80		46	75	mW
	No load, $V_{CC\pm} = \pm 3\text{ V}$			4	8		4	6	
	No load	-55°C to 125°C			100			90	

NOTES: 3. The input offset voltage for all devices is measured with high-speed test equipment approximately 1 second after power is applied. The LT1001AM receives a 168-hour burn-in at 125°C or equivalent.

4. Long-term drift of input offset voltage refers to the average trend line of offset voltage versus time over extended periods after the first 30 days of operation. Excluding the initial hour of operation, the change in  $V_{IO}$  during the first 30 days is typically 2.5  $\mu\text{V}$ .

operating characteristics,  $V_{CC\pm} = \pm 15\text{ V}, T_A = 25^\circ\text{C}$  (unless otherwise noted)

PARAMETER	TEST CONDITIONS	LT1001M			LT1001AM			UNIT
		MIN	TYP	MAX	MIN	TYP	MAX	
SR Slew rate at unity gain	$R_L \geq 2\text{ k}\Omega$	0.1	0.25		0.1	0.25		V/ $\mu\text{s}$
$\phi_m$ Phase margin at unity gain	$A_v = 40\text{ dB}, R_S = 100\ \Omega, C_L = 10\text{ pF}$	$T_A = 25^\circ\text{C}$		60°		63°		
		$T_A = \text{MIN}$		63°		63°		
		$T_A = \text{MAX}$		57°		57°		
$V_{NPP}$ Peak-to-peak equivalent input noise voltage	$f = 0.1\text{ Hz to } 10\text{ Hz}$		0.3	0.6		0.3	0.6	$\mu\text{V}$
$V_n$ Equivalent input noise voltage	$f = 10\text{ Hz}$		10.5	18		10.3	18	nV/ $\sqrt{\text{Hz}}$
	$f = 1\text{ MHz}$		9.8	11		9.6	11	
GBW Gain bandwidth product		0.4	0.8		0.4	0.8		MHz

# LT1001C, LT1001AC PRECISION OPERATIONAL AMPLIFIERS

## electrical characteristics, $V_{CC\pm} = \pm 15\text{ V}$ (unless otherwise noted)

PARAMETER	TEST CONDITIONS	$T_A$	LT1001C			LT1001AC			UNIT
			MIN	TYP	MAX	MIN	TYP	MAX	
$V_{IO}$ Input offset voltage	See Note 5	25°C	18		60	10		25	$\mu\text{V}$
		0°C to 70°C	110			60			
$\alpha_{VIO}$ Average temperature coefficient of input offset voltage		0°C to 70°C	0.3		1	0.2		0.6	$\mu\text{V}/^\circ\text{C}$
Long-term drift of input offset voltage	See Note 4		0.3		1.5	0.2		1	$\mu\text{V}/\text{mo}$
$I_{IO}$ Input offset current	$V_O = 0, V_{IC} = 0$	25°C	0.4		3.8	0.3		2	nA
		0°C to 70°C	5.3			3.5			
$I_{IB}$ Input bias current	$V_O = 0, V_{IC} = 0$	25°C	$\pm 0.7$		$\pm 4$	$\pm 0.5$		$\pm 2$	nA
		0°C to 70°C	$\pm 5.5$			$\pm 3.5$			
$V_{OH}$ Maximum peak output voltage swing	$R_L \geq 2\text{ k}\Omega$	25°C	$\pm 13$	$\pm 14$		$\pm 13$	$\pm 14$		V
			$R_L \geq 1\text{ k}\Omega$	$\pm 12$	$\pm 13.5$		$\pm 12$	$\pm 13.5$	
	$R_L \geq 2\text{ k}\Omega$	0°C to 70°C	$\pm 12.5$			$\pm 12.5$			
$A_{VD}$ Large-signal differential voltage amplification	$R_L \geq 2\text{ k}\Omega, V_O = \pm 12\text{ V}$	25°C	400		800	450		800	V/mV
			$R_L \geq 1\text{ k}\Omega, V_O = \pm 10\text{ V}$	250		500	300		
	$R_L \geq 2\text{ k}\Omega, V_O = \pm 10\text{ V}$	0°C to 70°C	250			350			
$r_{id}$ Differential input resistance		25°C	15	80		30	100	M $\Omega$	
CMRR Common-mode rejection ratio	$V_{IC} = \pm 13\text{ V}$	25°C	110	126		114	126	dB	
		0°C to 70°C	106			110			
$k_{SVR}$ Supply voltage rejection ratio	$V_{CC\pm} = \pm 3\text{ V to } \pm 18\text{ V}$	25°C	106	123		110	123	dB	
		0°C to 70°C	103			106			
$P_D$ Total power dissipation	No load	25°C	48		80	46		75	mW
	No load, $V_{CC\pm} = \pm 3\text{ V}$		4		8	4		6	
	No load		0°C to 70°C	90			85		

- Notes: 4. Long-term drift of input offset voltage refers to the average trend line of offset voltage versus time over extended periods after the first 30 days of operation. Excluding the initial hour of operation, the change in  $V_{IO}$  during the first 30 days is typically 2.5  $\mu\text{V}$ .  
5. The input offset voltage for all devices is measured with high-speed test equipment approximately 1 second after power is applied.

## operating characteristics, $V_{CC\pm} = \pm 15\text{ V}, T_A = 25^\circ\text{C}$ (unless otherwise noted)

PARAMETER	TEST CONDITIONS	LT1001C			LT1001AC			UNIT
		MIN	TYP	MAX	MIN	TYP	MAX	
SR Slew rate at unity gain	$R_L \geq 2\text{ k}\Omega$	0.1	0.25		0.1	0.25		V/ $\mu\text{s}$
$\phi_m$ Phase margin at unity gain	$A_V = 40\text{ dB}, R_S = 100\ \Omega, C_L = 10\text{ pF}$	$T_A = 25^\circ\text{C}$	60°		63°			
		$T_A = \text{MIN}$	63°		63°			
		$T_A = \text{MAX}$	57°		57°			
$V_{NPP}$ Peak-to-peak equivalent input noise voltage	$f = 0.1\text{ Hz to } 10\text{ Hz}$	0.3	0.6		0.3	0.6		$\mu\text{V}$
$V_n$ Equivalent input noise voltage	$f = 10\text{ Hz}$	10.5	18		10.3	18		nV/ $\sqrt{\text{Hz}}$
	$f = 1\text{ MHz}$	9.8	11		9.6	11		
GBW Gain bandwidth product		0.4	0.8		0.4	0.8		MHz

2

Operational Amplifiers

**LT1001M, LT1001AM, LT1001C, LT1001AC**  
**PRECISION OPERATIONAL AMPLIFIER**

**TYPICAL CHARACTERISTICS†**

**2**  
**Operational Amplifiers**

**INPUT OFFSET VOLTAGE  
 OF REPRESENTATIVE UNITS  
 vs  
 FREE-AIR TEMPERATURE**

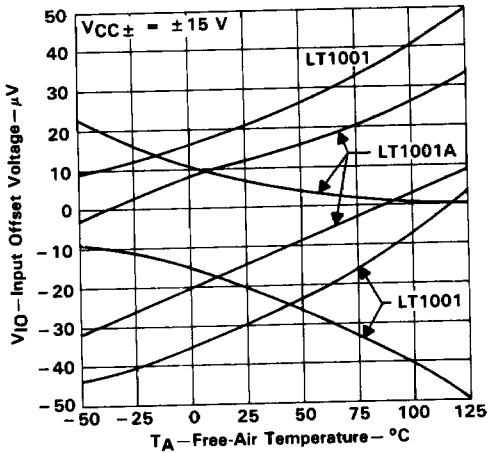

**FIGURE 1**

**WARM-UP CHANGE  
 IN INPUT OFFSET VOLTAGE  
 vs  
 ELAPSED TIME**

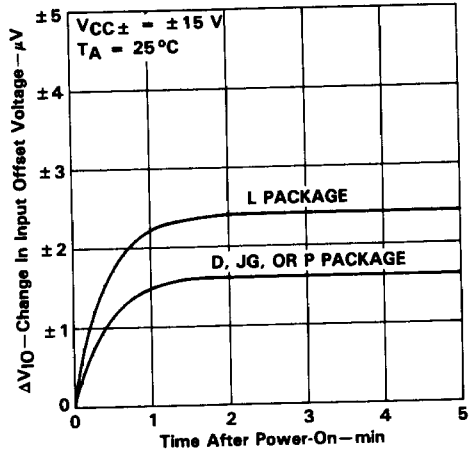

**FIGURE 2**

**LONG-TERM DRIFT OF  
 INPUT OFFSET VOLTAGE  
 OF REPRESENTATIVE UNITS**

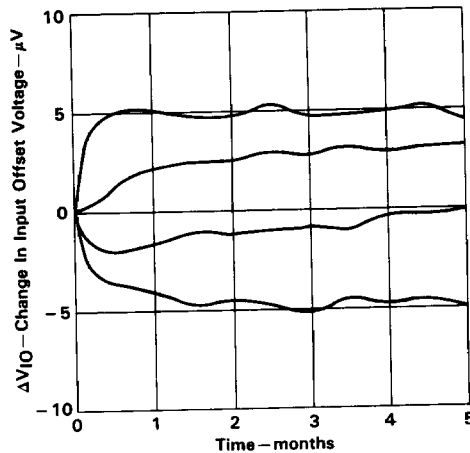

**FIGURE 3**

†Data at high and low temperatures are applicable only within the rated operating free-air temperature ranges of the various devices.

TYPICAL CHARACTERISTICS†

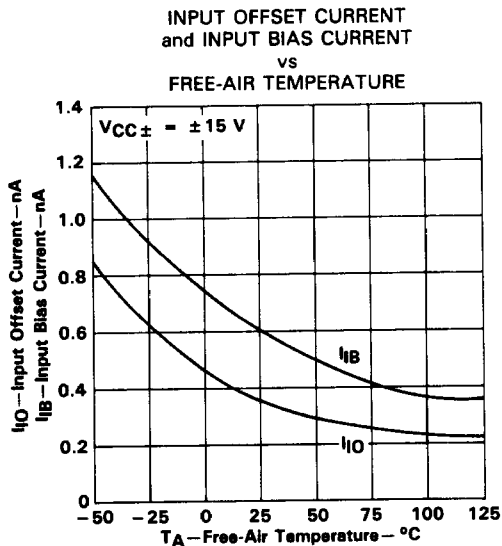

FIGURE 4

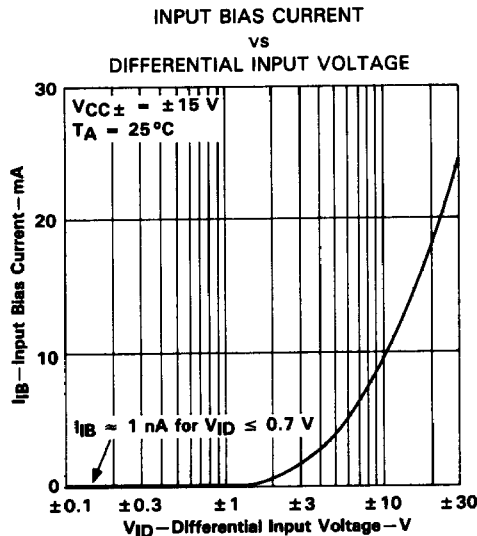

FIGURE 5

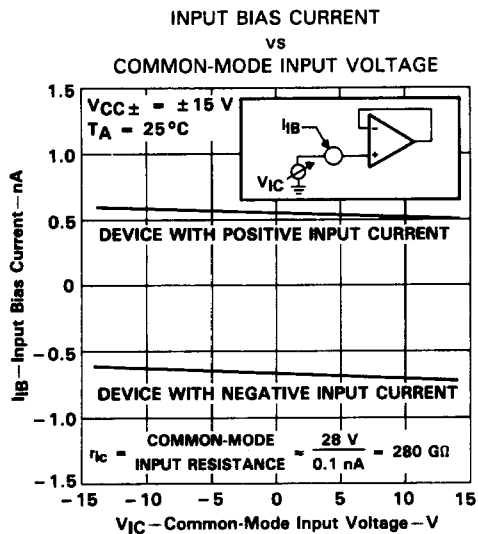

FIGURE 6

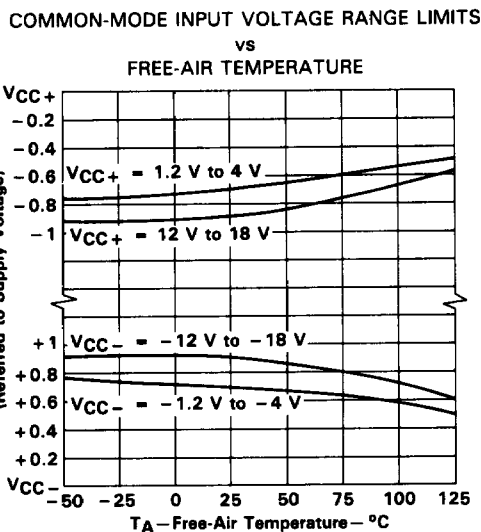

FIGURE 7

2

Operational Amplifiers

†Data at high and low temperatures are applicable only within the rated operating free-air temperature ranges of the various devices.

TYPICAL CHARACTERISTICS†

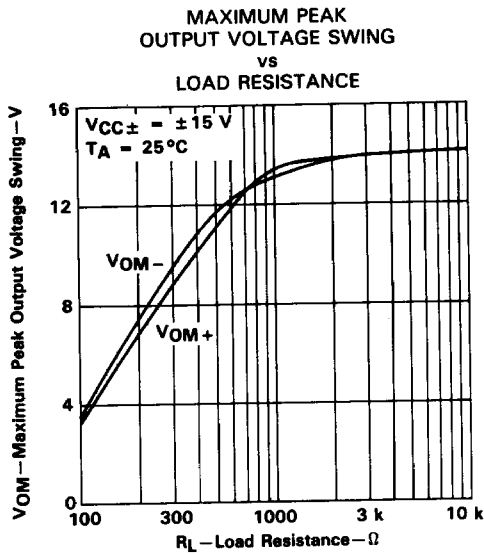

FIGURE 8

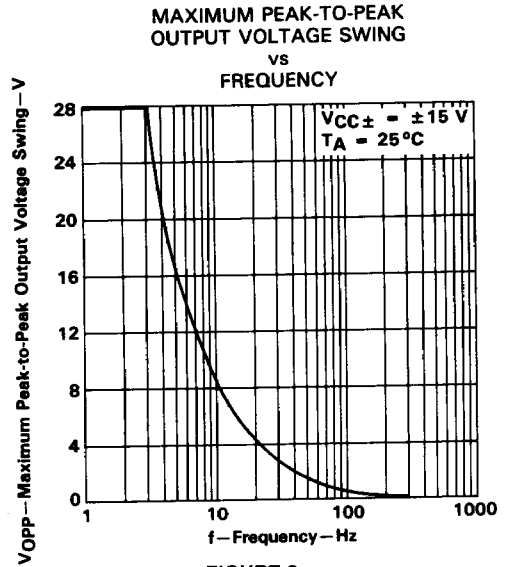

FIGURE 9

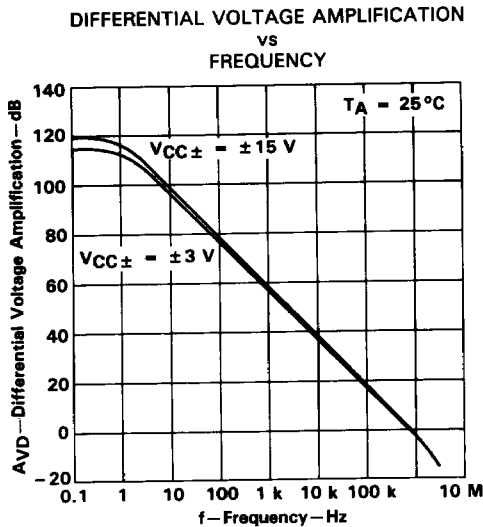

FIGURE 10

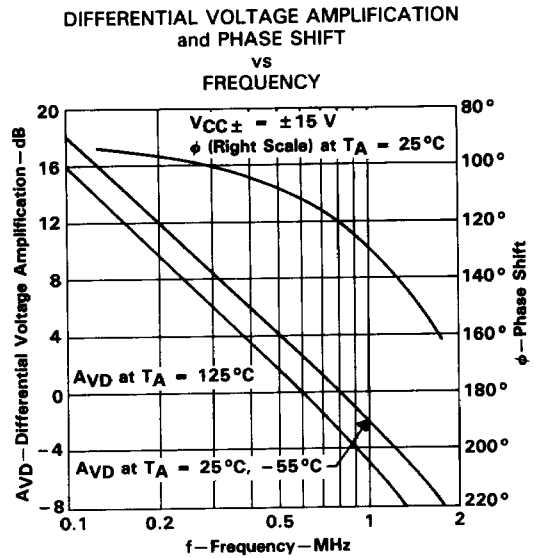

FIGURE 11

†Data at high and low temperatures are applicable only within the rated operating free-air temperature ranges of the various devices.



TYPICAL CHARACTERISTICS†

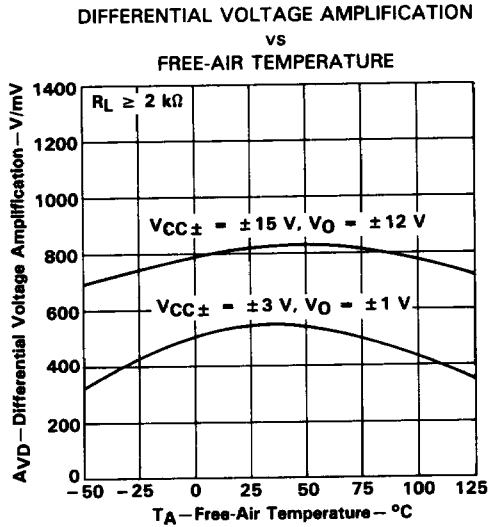

FIGURE 12

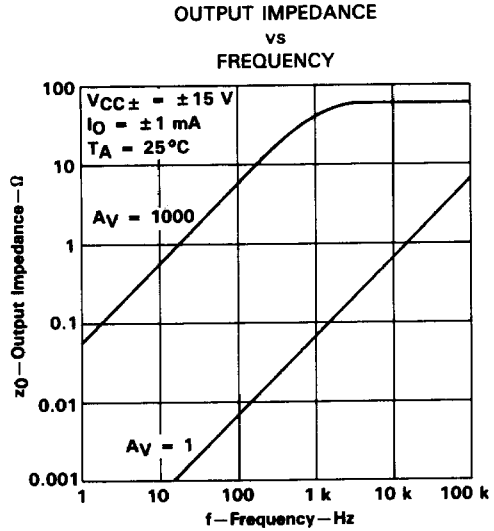

FIGURE 13

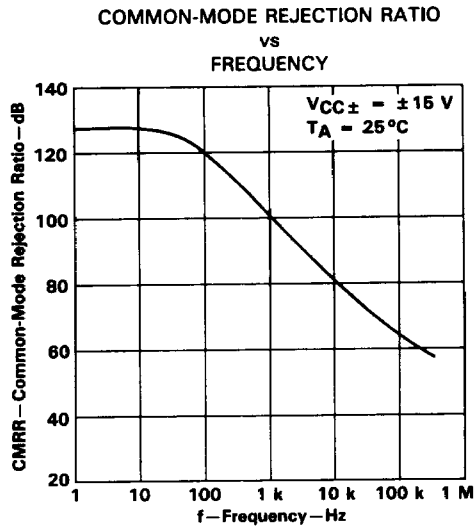

FIGURE 14

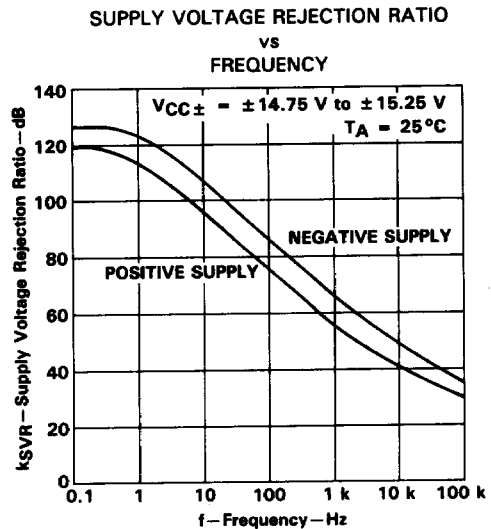

FIGURE 15

2

Operational Amplifiers

†Data at high and low temperatures are applicable only within the rated operating free-air temperature ranges of the various devices.

TYPICAL CHARACTERISTICS†

SUPPLY CURRENT  
vs  
SUPPLY VOLTAGE

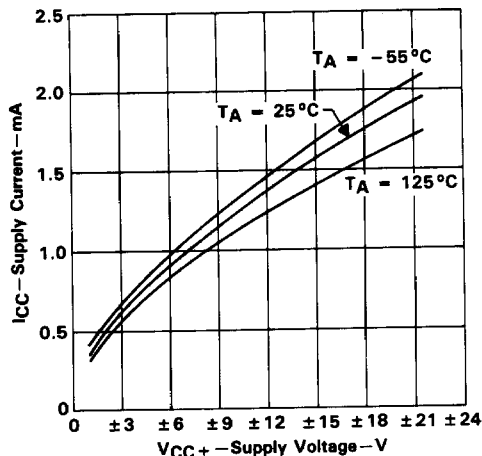

FIGURE 16

SHORT-CIRCUIT OUTPUT CURRENT  
vs  
ELAPSED TIME

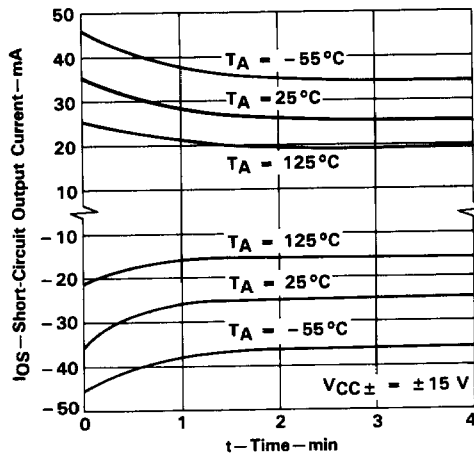

FIGURE 17

EQUIVALENT INPUT NOISE VOLTAGE  
and EQUIVALENT INPUT NOISE CURRENT  
vs  
FREQUENCY

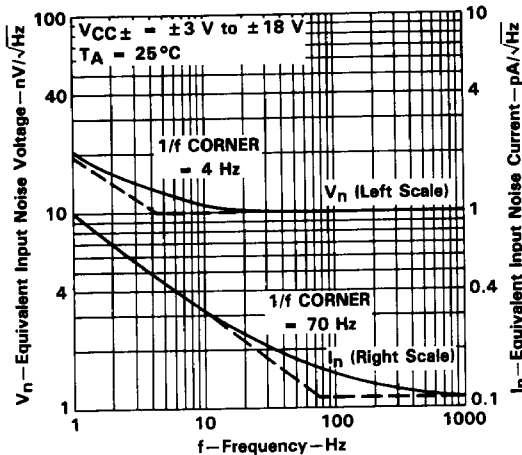

FIGURE 18

OUTPUT NOISE VOLTAGE  
OVER A  
10-SECOND PERIOD

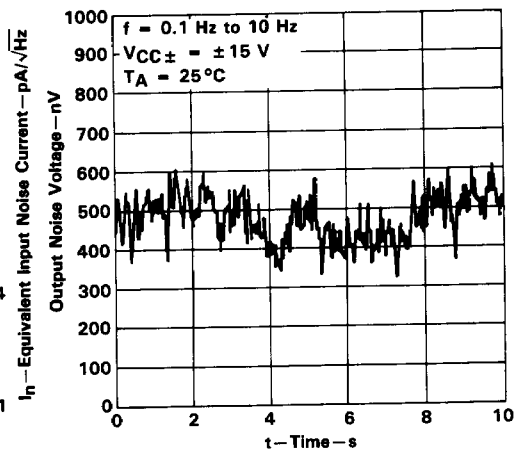

FIGURE 19

†Data at high and low temperatures are applicable only within the rated operating free-air temperature ranges of the various devices.

TYPICAL CHARACTERISTICS

VOLTAGE-FOLLOWER  
SMALL-SIGNAL  
PULSE RESPONSE

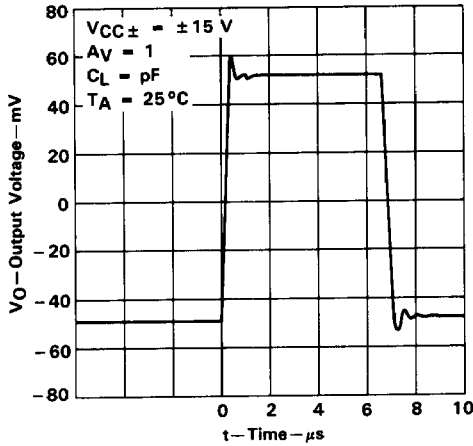

FIGURE 20

VOLTAGE-FOLLOWER  
SMALL-SIGNAL  
PULSE RESPONSE

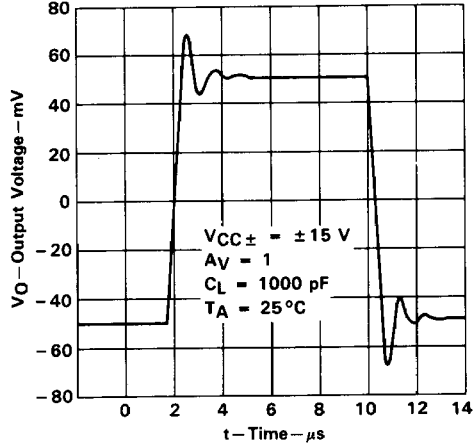

FIGURE 21

VOLTAGE-FOLLOWER  
LARGE-SIGNAL  
PULSE-RESPONSE

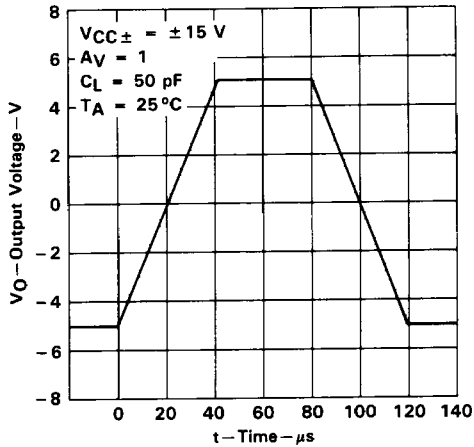

FIGURE 22

VOLTAGE-FOLLOWER OVERSHOOT  
vs  
LOAD CAPACITANCE

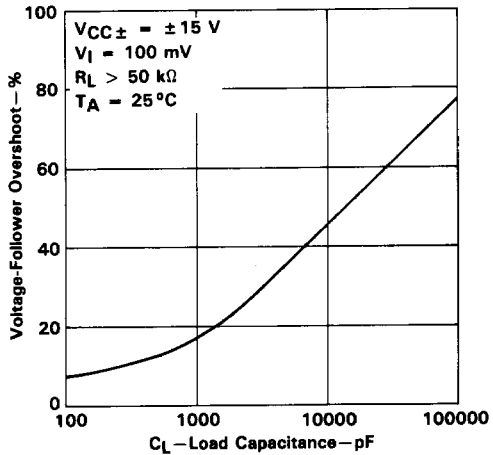

FIGURE 23

2

Operational Amplifiers

PARAMETER MEASUREMENT INFORMATION

2

Operational Amplifiers

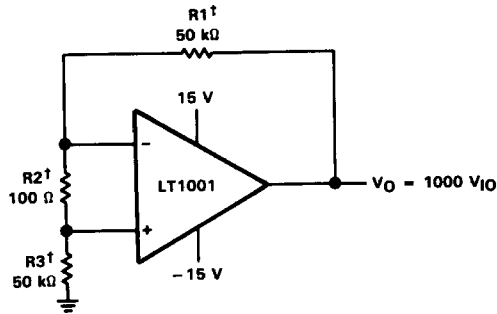

†Resistors must have low thermoelectric potential.

NOTE: This circuit is also used as the burn-in configuration for the LT1001 with supply voltages increased to  $\pm 20$  V,  $R_1 = R_3 = 10$  k $\Omega$ ,  $R_2 = 200$   $\Omega$ , and  $A_v = 100$ .

FIGURE 24. TEST CIRCUIT FOR INPUT OFFSET VOLTAGE AND ITS TEMPERATURE COEFFICIENT

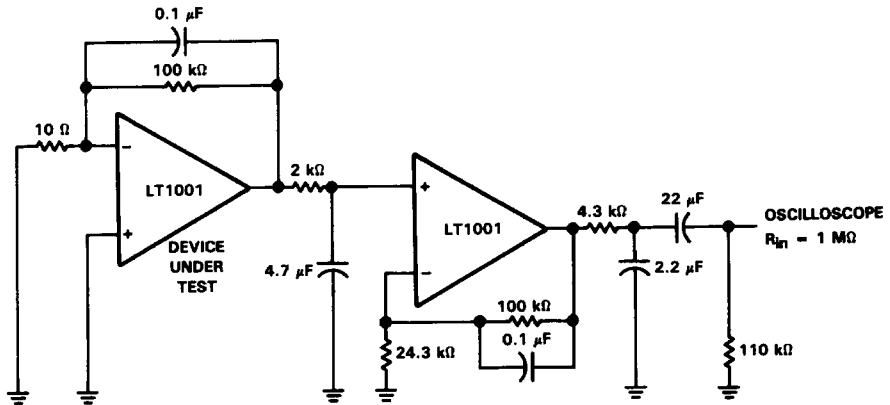

NOTES: A.  $A_v = 50,000$ .

B. The device under test should be warmed up for three minutes and shielded from air currents.

FIGURE 25. TEST CIRCUIT FOR 0.1-Hz TO 10-Hz PEAK-TO-PEAK NOISE VOLTAGE (MEASURED OVER A 10-SECOND INTERVAL)

**TYPICAL APPLICATION DATA**

**application notes**

The LT1001 series units may be inserted directly into OP-07 or LM108A sockets with or without removing external frequency compensation or nulling components.

The LT1001 is specified over a wide range of supply voltages from  $\pm 3$  V to  $\pm 18$  V. Operation with lower supply voltages (e.g., two Ni-Cad batteries) is possible down to  $\pm 1.2$  V. However, with  $\pm 1.2$ -V supplies, the device is stable only in closed-loop gains of 2 or higher (or inverting gains of one or higher).

Unless proper care is exercised, thermocouple effects caused by temperature gradients across dissimilar metals at the contacts to the input terminals can exceed the inherent temperature coefficient of the amplifier. Air currents over device leads should be minimized, package leads should be short, and the two input leads should be as close together as possible and maintained at the same temperature.

2

Operational Amplifiers

**input offset voltage adjustment**

The input offset voltage and temperature coefficient of the LT1001 are permanently trimmed to a low level at wafer test. However, if further adjustment of  $V_{IO}$  is necessary, nulling with a 10-k $\Omega$  or 20-k $\Omega$  potentiometer will not degrade the temperature coefficient. Trimming to a value other than zero creates a temperature coefficient change of  $(V_{IO}/300)$   $\mu\text{V}/^\circ\text{C}$ . For example, if  $V_{IO}$  is adjusted to 300  $\mu\text{V}$ , the change in the temperature coefficient will be 1  $\mu\text{V}/^\circ\text{C}$ . The adjustment range with a 10-k $\Omega$  or 20-k $\Omega$  potentiometer is approximately  $\pm 2.5$  mV. If less adjustment range is needed, the sensitivity and resolution of the nulling can be improved by using a smaller potentiometer in conjunction with fixed resistors. The example in Figure 26 has an approximate null range of  $\pm 100$   $\mu\text{V}$ .

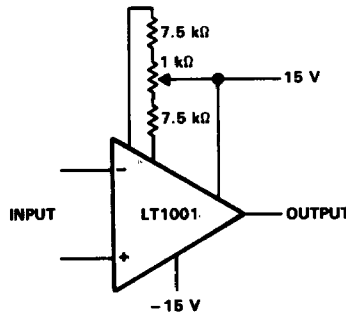
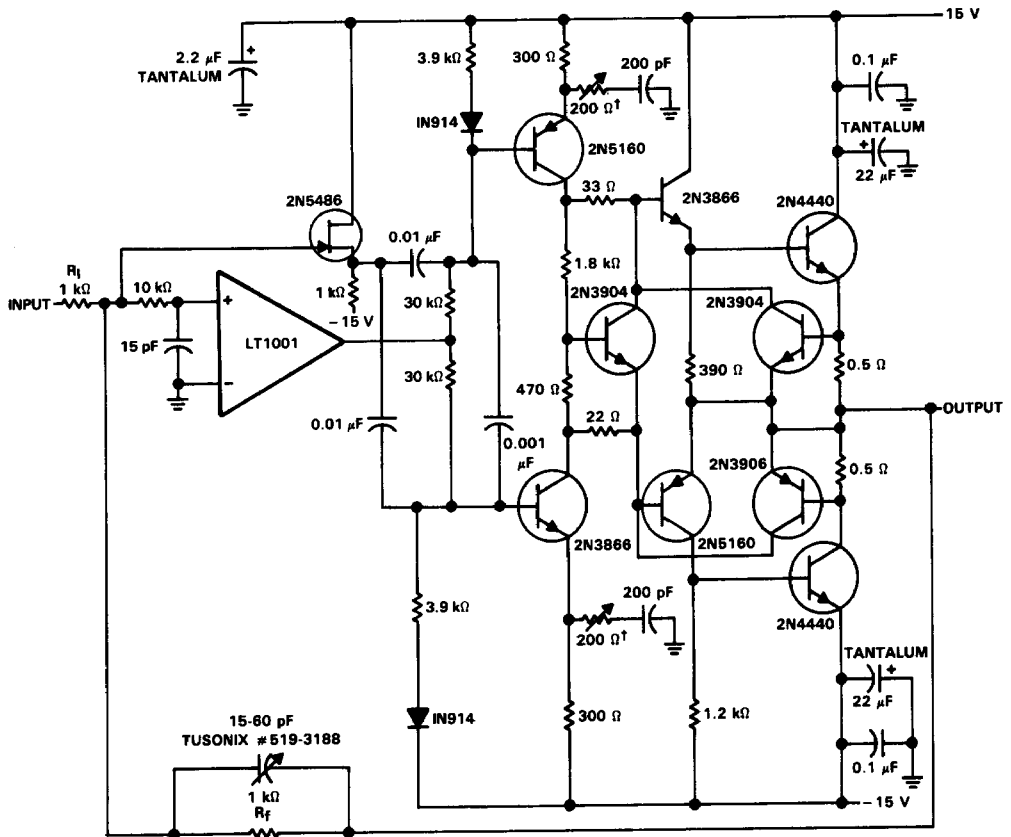

**FIGURE 26. IMPROVED SENSITIVITY ADJUSTMENT**

**LT1001  
PRECISION OPERATIONAL AMPLIFIER**

**TYPICAL APPLICATION DATA**

**2  
Operational Amplifiers**



†Adjust for best square wave at output.  
NOTE: Full-power bandwidth is 8 MHz.

**FIGURE 27. DC-STABILIZED 1000-V/μs OPERATIONAL AMPLIFIER**

TYPICAL APPLICATION DATA

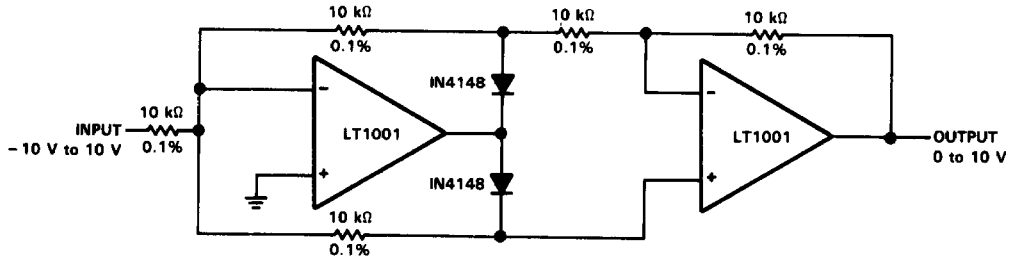

FIGURE 28. PRECISION ABSOLUTE VALUE CIRCUIT

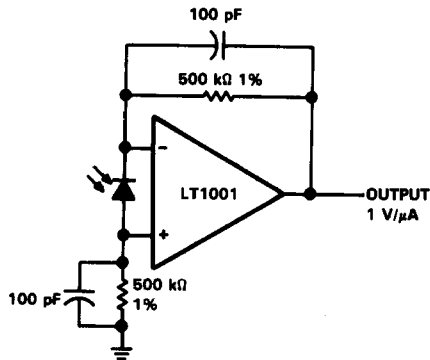

FIGURE 29. PHOTODIODE AMPLIFIER.

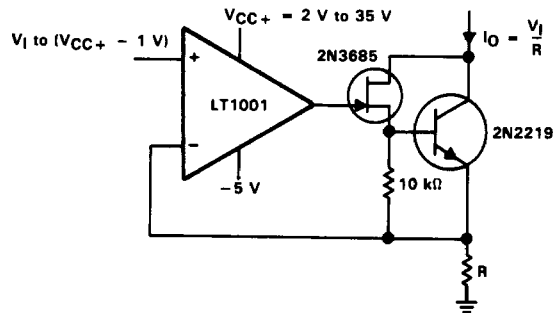

FIGURE 30. PRECISION CURRENT SINK

2

Operational Amplifiers

# LT1001 PRECISION OPERATIONAL AMPLIFIER

## TYPICAL APPLICATION DATA

### 2 Operational Amplifiers

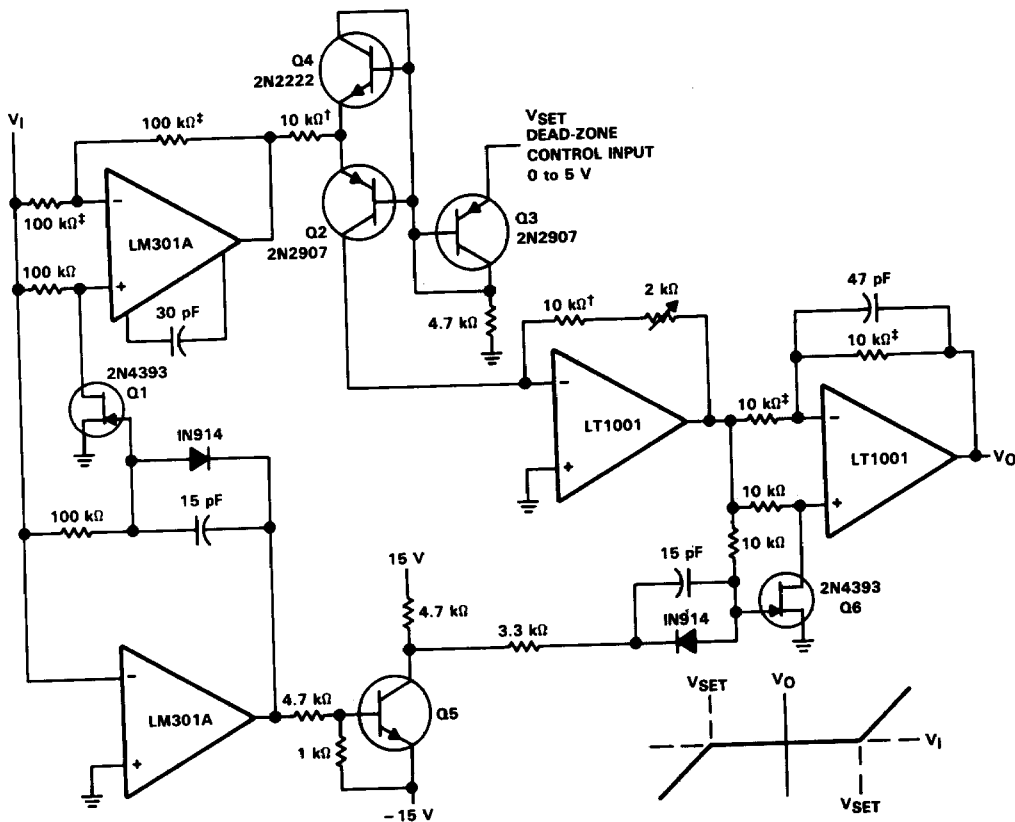

† 1% film

‡ Ratio match 0.05%

NOTES: A. The bipolar symmetry for this application is excellent because one device, Q2, sets both limits.

B. Q2-Q5 are a CA 3096 transistor array.

FIGURE 31. DEAD-ZONE GENERATOR



TYPICAL APPLICATION DATA

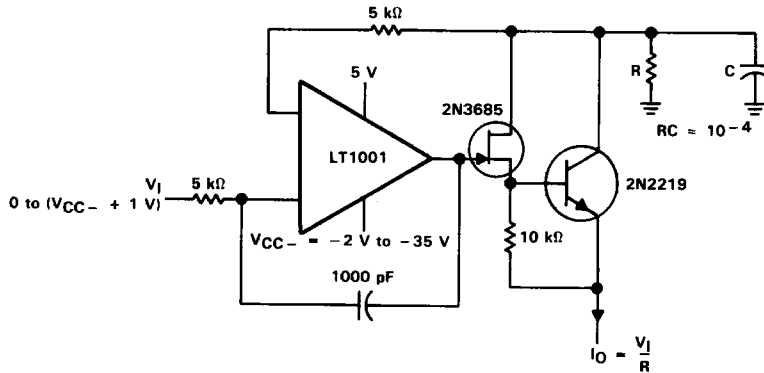
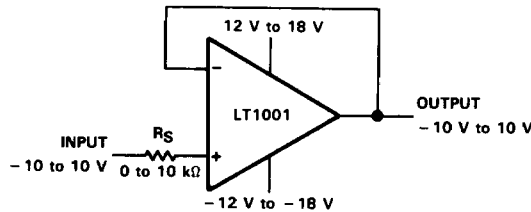

FIGURE 32. PRECISION CURRENT SOURCE



OUTPUT ACCURACY

ERROR	LT1001AM	LT1001C	LT1001AM	LT1001C
	$T_A = 25^\circ\text{C}$ MAX	$T_A = 25^\circ\text{C}$ MAX	$T_A = -55^\circ\text{C to } 125^\circ\text{C}$ MAX	$T_A = 0^\circ\text{C to } 70^\circ\text{C}$ MAX
Input Offset Voltage	15 $\mu\text{V}$	60 $\mu\text{V}$	60 $\mu\text{V}$	110 $\mu\text{V}$
Input Bias Current	20 $\mu\text{V}$	40 $\mu\text{V}$	40 $\mu\text{V}$	55 $\mu\text{V}$
Common-Mode Rejection Ratio	20 $\mu\text{V}$	30 $\mu\text{V}$	30 $\mu\text{V}$	50 $\mu\text{V}$
Supply Voltage Rejection Ratio	18 $\mu\text{V}$	30 $\mu\text{V}$	36 $\mu\text{V}$	42 $\mu\text{V}$
Differential Voltage Amplification	22 $\mu\text{V}$	25 $\mu\text{V}$	33 $\mu\text{V}$	40 $\mu\text{V}$
Worst-case Sum	95 $\mu\text{V}$	185 $\mu\text{V}$	199 $\mu\text{V}$	297 $\mu\text{V}$
Percent of Full Scale (= 20 V)	0.0005%	0.0009%	0.0010%	0.0015%

NOTE: The contributing error terms are due to input offset voltage, input bias current, voltage gain, common-mode rejection ratio, and supply voltage rejection ratio. The worst-case specifications are given in the above table.

FIGURE 33. LARGE-SIGNAL VOLTAGE FOLLOWER WITH 0.001% WORST-CASE ACCURACY



TYPICAL APPLICATION DATA

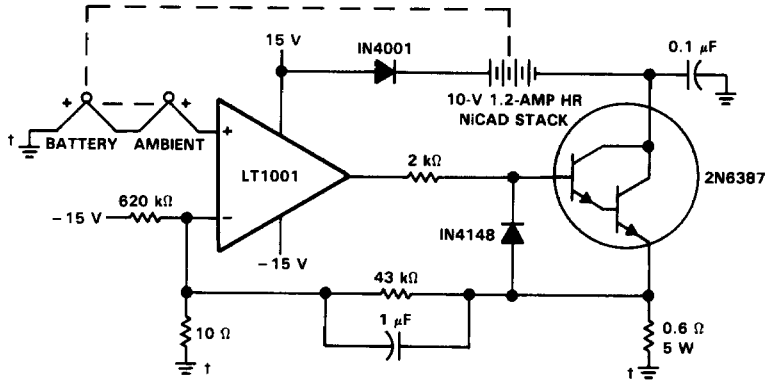

†Single point ground thermocouples are 40  $\mu\text{V}/^\circ\text{C}$  chromel-alumel (type K).  
NOTE: This circuit uses the temperature difference between the battery pack mounted thermocouple and the ambient thermocouple to set the battery charge current. The peak charging current is 1 A.

FIGURE 36. THERMALLY CONTROLLED NICAD CHARGER

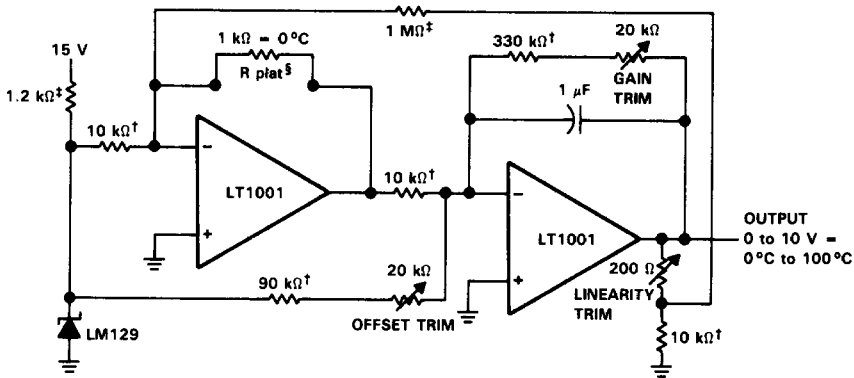

†ULTRONIX 105A wirewound

‡1% film

§Platinum RTD 118MF (Rosemount, Inc.)

NOTE: Trim sequence: trim offset ( $0^\circ\text{C} = 1000\ \Omega$ ), trim linearity ( $35^\circ\text{C} = 1138.7\ \Omega$ ), trim gain ( $100^\circ\text{C} = 1392.6\ \Omega$ ). Repeat until all three points are fixed with  $\pm 0.025^\circ\text{C}$ .

FIGURE 37. LINEARIZED PLATINUM RESISTANCE THERMOMETER WITH  $\pm 0.025^\circ\text{C}$  ACCURACY FOR  $T_A = 0^\circ\text{C}$  TO  $100^\circ\text{C}$

2  
Operational Amplifiers