



PM-1012

LOW-POWER, PRECISION
OPERATIONAL AMPLIFIER

Precision Monolithics Inc.

FEATURES

- **Low Supply Current** **600 μ A Max**
- **Very Low Offset** **35 μ V Max**
- **Low Drift** **1.5 μ V/ $^{\circ}$ C Max**
- **Very Low Bias Current**
25 $^{\circ}$ C **100pA Max**
-55 $^{\circ}$ C to +125 $^{\circ}$ C **250pA Max**
- **Low Noise** **0.5 μ V_{p-p} Typ**
- **High Common-Mode Rejection** **114dB Min**
- **Available in Die Form**

ORDERING INFORMATION †

| V _{OS} (μ V) | PACKAGE | | | OPERATING TEMPERATURE RANGE |
|-------------------------------|-----------|-----------------|------------------|-----------------------------------|
| | TO-99 | CERDIP 8-PIN | PLASTIC 8-PIN | |
| 35 | PM1012AJ* | PM1012AZ* | - | MIL |
| 50 | PM1012GJ | PM1012GZ | - | COM |
| 50 | - | - | PM1012GP | XIND |
| 50 | - | - | PM1012GS | XIND |

* For devices processed in total compliance to MIL-STD-883, add /883 after part number. Consult factory for 883 data sheet.

† Burn-in is available on commercial and industrial temperature range parts in CerDIP, plastic DIP, and TO-can packages. For ordering information, see PMI's Data Book, Section 2.

GENERAL DESCRIPTION

The PM-1012 is a general-purpose, precision operational amplifier. Offering several performance enhancements over

industry-standard precision op amps such as the OP-07, the PM-1012 requires less than 1/6 the supply current. These enhancements include exceptionally low bias currents of only ± 80 pA, typical, over the full military temperature range and 132dB of common-mode rejection and power-supply rejection. The PM-1012's low offset voltage of 35 μ V maximum frees the user from external nulling in most circuits.

An open-loop gain of two million into a 10k Ω load ensures that excellent linearity is maintained even in high-gain configurations, and 5mA of output current allows 2k Ω loads to be driven

PIN CONNECTIONS

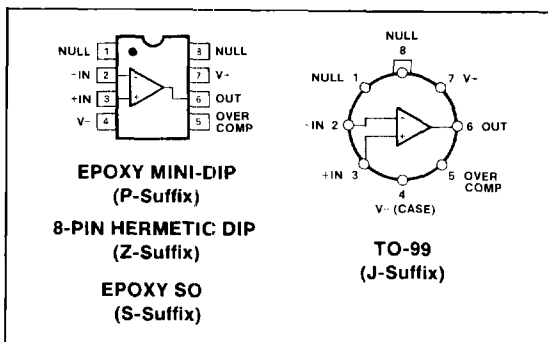

SIMPLIFIED SCHEMATIC

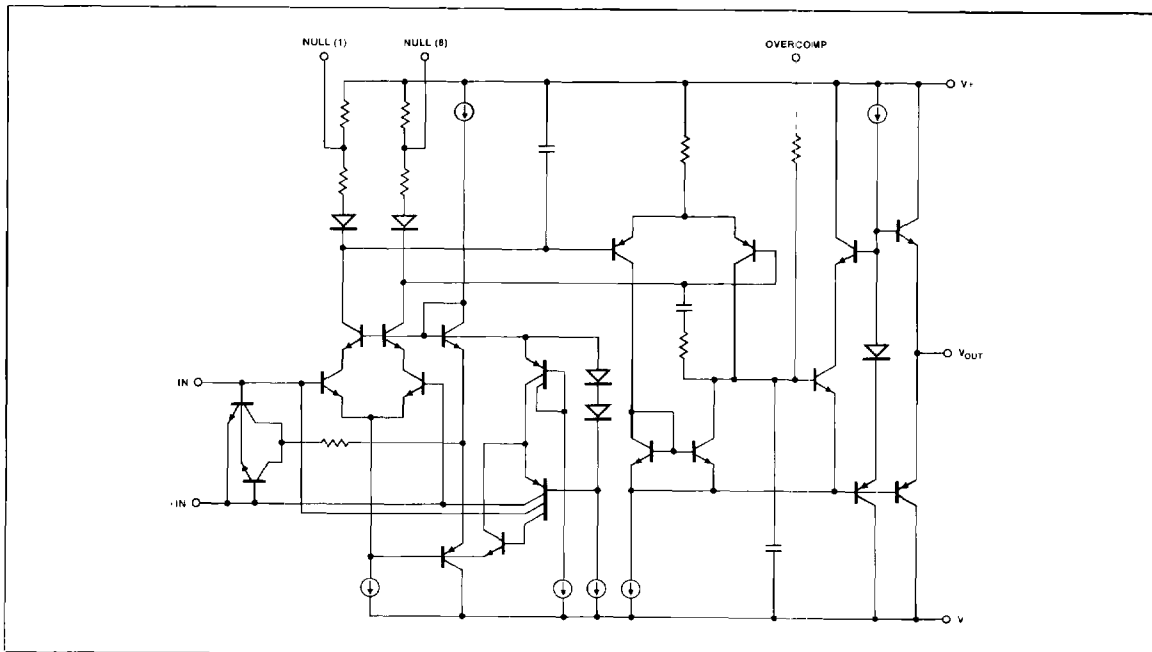

with an open-loop gain of one million. The PM-1012 offers low noise, especially for a low-power amplifier — only $17\text{nV}/\sqrt{\text{Hz}}$ at 10Hz. Exceptionally low current noise minimizes noise contributions when high source impedances are used. The PM-1012 may be overcompensated using pin 5 to limit the amplifier's bandwidth, further reducing system noise and increasing stability with large capacitive loads.

The PM-1012 conforms to the OP-07 pinout with nulling through pins 1 and 8 to the positive supply. It offers an upgrade to the OP-07 in sockets where reduced power dissipation or low bias currents are attractive. It may also be used as an upgrade from the OP-12, OP-05 and 725 type op amps. The PM-1012 may replace 741 type op amps by removing the nulling potentiometer, if used. For an externally compensated amplifier sharing many of the PM-1012's precision specifications, see the PM-1008 data sheet.

ABSOLUTE MAXIMUM RATINGS (Note 1)

| | |
|---|-------------------|
| Supply Voltage | $\pm 20\text{V}$ |
| Input Voltage (Note 3) | $\pm 20\text{V}$ |
| Differential Input Voltage (Note 4) | $\pm 1\text{V}$ |
| Differential Input Current (Note 4) | $\pm 10\text{mA}$ |
| Output Short-Circuit Duration | Indefinite |

Operating Temperature Range

| | |
|--|---|
| PM-1012A (J,Z) | -55°C to $+125^\circ\text{C}$ |
| PM-1012G (J,Z) | 0°C to $+70^\circ\text{C}$ |
| PM-1012G (P,S) | -40°C to $+85^\circ\text{C}$ |
| Storage Temperature Range | -65°C to $+150^\circ\text{C}$ |
| Junction Temperature Range | -65°C to $+150^\circ\text{C}$ |
| Lead Temperature (Soldering, 10 sec) | $+300^\circ\text{C}$ |

| PACKAGE TYPE | θ_{JA} (Note 2) | θ_{JC} | UNITS |
|------------------------|------------------------|---------------|---------------------------|
| TO-99 (J) | 150 | 18 | $^\circ\text{C}/\text{W}$ |
| 8-Pin Hermetic DIP (Z) | 148 | 16 | $^\circ\text{C}/\text{W}$ |
| 8-Pin Plastic DIP (P) | 103 | 43 | $^\circ\text{C}/\text{W}$ |
| 8-Pin SO (S) | 158 | 43 | $^\circ\text{C}/\text{W}$ |

NOTES:

1. Absolute maximum ratings apply to both DICE and packaged parts, unless otherwise noted.
2. θ_{JA} is specified for worst case mounting conditions, i.e., θ_{JA} is specified for device in socket for TO, CerDIP and P-DIP packages; θ_{JA} is specified for device soldered to printed circuit board for SO package.
3. For supply voltages less than $\pm 20\text{V}$, the absolute maximum input voltage is equal to the supply voltage.
4. The PM-1012's inputs are protected by back-to-back diodes. Current-limiting resistors are not used in order to achieve low noise. Differential input voltages greater than 1V will cause excessive current to flow through the input protection diodes unless limiting resistance is used.

ELECTRICAL CHARACTERISTICS at $V_S = \pm 15\text{V}$, $V_{CM} = 0\text{V}$, $T_A = 25^\circ\text{C}$ unless otherwise noted.

| PARAMETER | SYMBOL | CONDITIONS | PM-1012A | | | PM-1012G | | | UNITS |
|------------------------------|-----------------------------|---|------------|----------------------|------------------------|------------|----------------------|------------------------|------------------------------|
| | | | MIN | TYP | MAX | MIN | TYP | MAX | |
| Input Offset Voltage | V_{OS} | (Note 1) | — | 8 20 | 35 90 | — | 10 25 | 50 120 | μV |
| Long-Term V_{OS} Stability | $\Delta V_{OS}/\text{Time}$ | | — | 0.3 | — | — | 0.3 | — | $\mu\text{V}/\text{month}$ |
| Input Offset Current | I_{OS} | (Note 1) | — | 15 25 | 100 150 | — | 20 30 | 150 200 | μA |
| Input Bias Current | I_B | (Note 1) | — | ± 25 ± 35 | ± 100 ± 150 | — | ± 30 ± 40 | ± 150 ± 200 | μA |
| Input Noise Voltage | e_{np-p} | 0.1Hz to 10Hz | — | 0.5 | — | — | 0.5 | — | μV_{p-p} |
| Input Noise Voltage Density | e_n | $f_O = 10\text{Hz}$ (Note 3) $f_O = 1000\text{Hz}$ (Note 4) | — | 17 14 | 30 22 | — | 17 14 | 30 22 | $\text{nV}/\sqrt{\text{Hz}}$ |
| Input Noise Current Density | i_N | $f_O = 10\text{Hz}$ | — | 20 | — | — | 20 | — | $\text{fA}/\sqrt{\text{Hz}}$ |
| Large-Signal Voltage Gain | A_{VO} | $V_O = \pm 12\text{V}$; $R_L = 10\text{k}\Omega$ $V_O = \pm 10\text{V}$; $R_L = 2\text{k}\Omega$ | 300 200 | 2000 1000 | — | 200 120 | 2000 1000 | — | V/mV |
| Common-Mode Rejection | CMR | $V_{CM} = \pm 13.5\text{V}$ | 114 | 132 | — | 110 | 132 | — | dB |
| Power-Supply Rejection | PSR | $V_S = \pm 2\text{V}$ to $\pm 20\text{V}$ | 114 | 132 | — | 110 | 132 | — | dB |
| Input Voltage Range | IVR | (Note 2) | ± 13.5 | ± 14.0 | — | ± 13.5 | ± 14.0 | — | V |
| Output Voltage Swing | V_O | $R_L = 10\text{k}\Omega$ | ± 13 | ± 14 | — | ± 13 | ± 14 | — | V |
| Slew Rate | SR | | 0.1 | 0.2 | — | 0.1 | 0.2 | — | $\text{V}/\mu\text{s}$ |
| Full-Power Bandwidth | BW_P | | — | 3 | — | — | 3 | — | kHz |
| Gain-Bandwidth Product | GBW | $A_V = 100$ | — | 0.5 | — | — | 0.5 | — | MHz |
| Supply Current | I_{SY} | (Note 1) | — | 380 | 600 | — | 380 | 600 | μA |
| Supply Voltage | V_S | Operating Range | ± 2 | ± 15 | ± 20 | ± 2 | ± 15 | ± 20 | V |

NOTES:

1. These specifications apply for $\pm 2\text{V} \leq V_S \leq \pm 20\text{V}$ and $-13.5\text{V} \leq V_{CM} \leq +13.5\text{V}$ (for $V_S = \pm 15\text{V}$).
2. Guaranteed by CMR test.
3. 10Hz noise voltage density is sample tested. Devices 100% tested for noise are available on request.
4. Sample Tested.



ELECTRICAL CHARACTERISTICS at $V_S = \pm 15V$, $V_{CM} = 0V$, $0^\circ C \leq T_A \leq +70^\circ C$ for PM-1012 GJ and GZ, $-40^\circ C \leq T_A \leq +85^\circ C$ or PM1012GP, GS and $-55^\circ C \leq T_A \leq +125^\circ C$ for PM-1012A, unless otherwise noted.

Table with 10 columns: PARAMETER, SYMBOL, CONDITIONS, and two columns for PM-1012A (MIN, TYP, MAX) and two columns for PM-1012G (MIN, TYP, MAX), plus a UNITS column. Rows include Input Offset Voltage, Temperature Coefficient of Vos, Input Offset Current, Temperature Coefficient of Ios, Input Bias Current, Temperature Coefficient of Ib, Large-Signal Voltage Gain, Common-Mode Rejection, Power-Supply Rejection, Input Voltage Range, Output Voltage Swing, Slew Rate, Supply Current, and Supply Voltage.

NOTES:

These specifications apply for $\pm 2.5V \leq V_S \leq \pm 20V$ and $-13.5V \leq V_{CM} \leq +13.5V$ (for $V_S = \pm 15V$). Guaranteed by CMR test.

WIRING-IN CIRCUIT

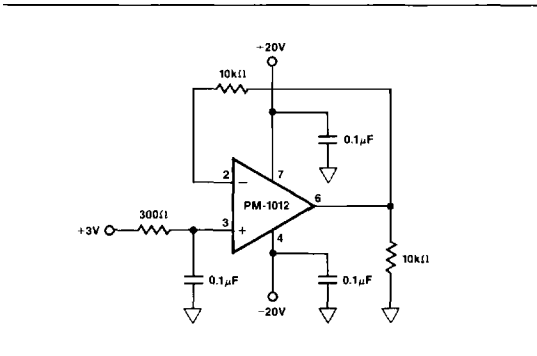

OPERATIONAL AMPLIFIERS/BUFFERS

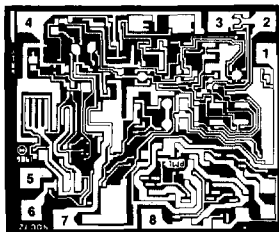
DICE CHARACTERISTICS

DIE SIZE 0.063 × 0.074 inch, 4662 sq. mils
(1.60 × 1.88 mm, 3.01 sq. mm)

1. NULL
2. INVERTING INPUT
3. NONINVERTING INPUT
4. V-
5. OVERCOMPENSATION
6. OUTPUT
7. V+
8. NULL

For additional DICE ordering information,
refer to PMI's Data Book, Section 2.

WAFER TEST LIMITS at $V_S = \pm 15V$, $V_{CM} = 0V$, $T_A = 25^\circ C$, unless otherwise noted.

| PARAMETER | SYMBOL | CONDITIONS | PM-1012N LIMIT | UNITS |
|------------------------------|----------|---|-------------------|----------------|
| Input Offset Voltage | V_{OS} | (Note 1) (Note 2) | 250 | μV MAX |
| | | | 300 | |
| Input Offset Current | I_{OS} | (Note 2) | 150 | pA MAX |
| | | | 200 | |
| Input Bias Current | I_B | (Note 2) | ± 150 | pA MAX |
| | | | ± 200 | |
| Large-Signal Voltage Gain | A_{VO} | $V_{OUT} = \pm 12V$, $R_L = 10k\Omega$ $V_{OUT} = \pm 10V$, $R_L = 2k\Omega$ | 200 | V/rmV MIN |
| | | | 120 | |
| Common-Mode Rejection | CMR | $V_{CM} = \pm 13.5V$ | 110 | dB MIN |
| Power-Supply Rejection | PSR | $V_S = \pm 2V$ to $\pm 20V$ | 110 | dB MIN |
| Input Voltage Range | IVR | (Note 3) | ± 13.5 | V MIN |
| Output Voltage Swing | V_O | $R_L = 10k\Omega$ | ± 13 | V MIN |
| Slew Rate | SR | | 0.1 | V/ μs MIN |
| Supply Current | I_{SY} | No Load | 600 | μA MAX |

NOTES:

1. Final offset trims are not performed on dice. These trims are typically performed after packaging. Precision Monolithics Inc. assumes no responsibility for improper trimming by the customer. Contact factory for trim methods.
2. These specifications apply for $\pm 2V \leq V_S \leq \pm 20V$ and $-13.5V \leq V_{CM} \leq +13.5V$ (for $V_S = \pm 15V$).
3. Guaranteed by CMR test.

Electrical tests are performed at wafer probe to the limits shown. Due to variations in assembly methods and normal yield loss, yield after packaging is not guaranteed for standard product dice. Consult factory to negotiate specifications based on dice lot qualification through sample lot assembly and testing.

TYPICAL PERFORMANCE CHARACTERISTICS

TYPICAL DISTRIBUTION OF INPUT OFFSET VOLTAGE

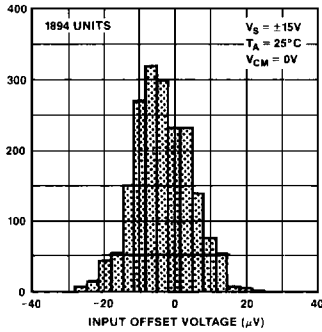

TYPICAL DISTRIBUTION OF INPUT BIAS CURRENT

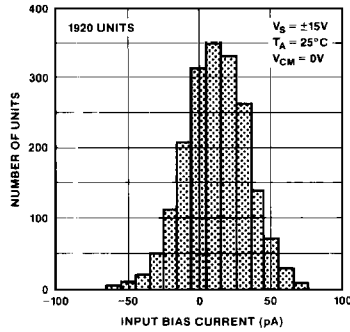

TYPICAL DISTRIBUTION OF INPUT OFFSET CURRENT

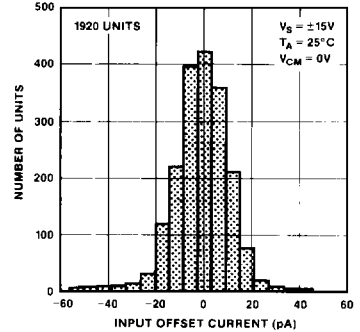

INPUT BIAS, OFFSET CURRENT vs TEMPERATURE

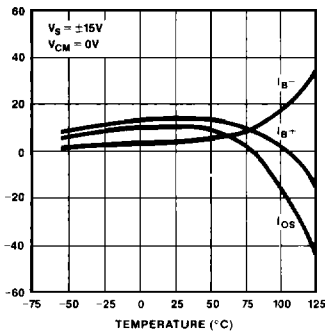

INPUT BIAS, OFFSET CURRENT vs COMMON-MODE VOLTAGE

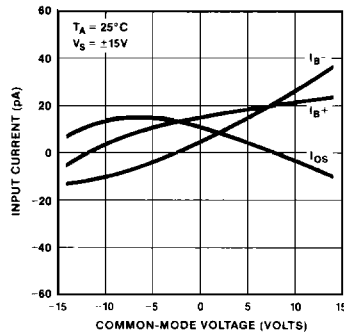

INPUT OFFSET VOLTAGE WARM-UP DRIFT

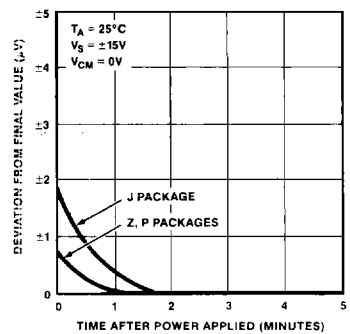

EFFECTIVE OFFSET VOLTAGE vs SOURCE RESISTANCE

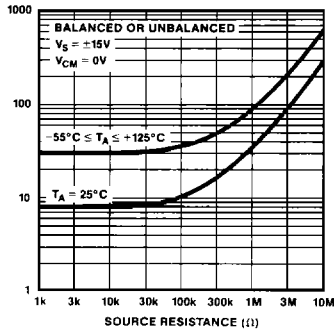

EFFECTIVE TCV_OS vs SOURCE RESISTANCE

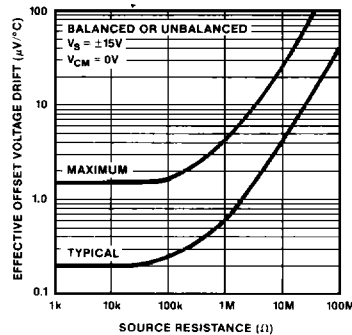

SHORT CIRCUIT CURRENT vs TIME, TEMPERATURE

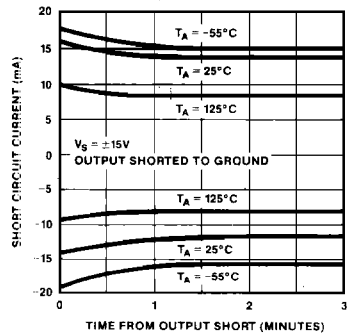

OPERATIONAL AMPLIFIERS/BUFFERS

TYPICAL PERFORMANCE CHARACTERISTICS

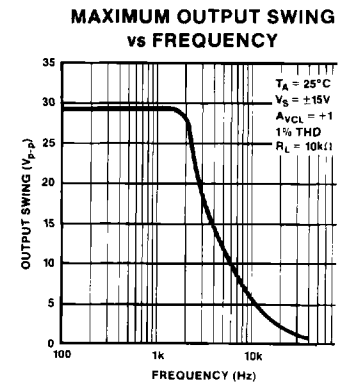
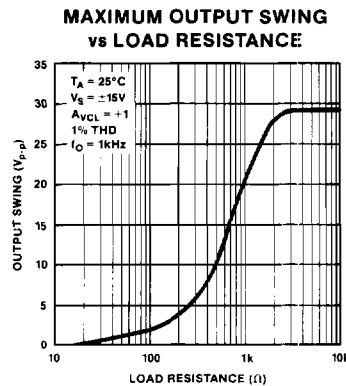
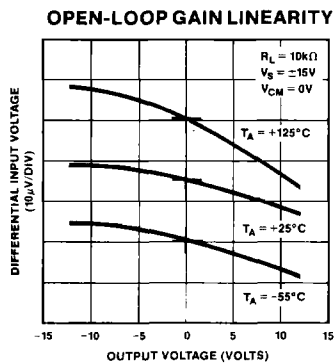
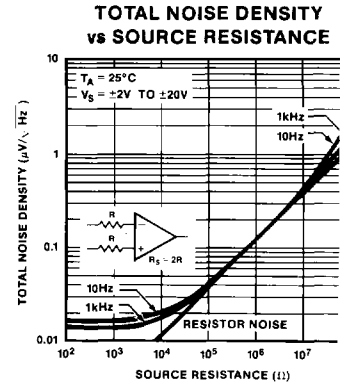
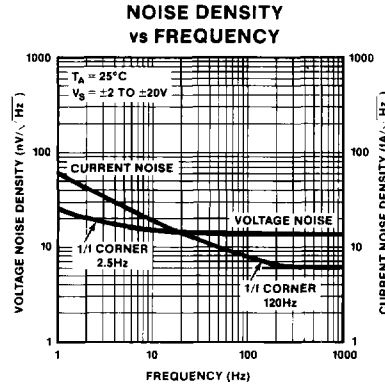
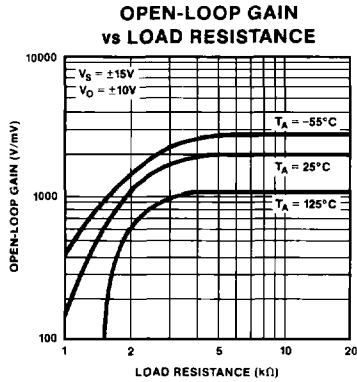
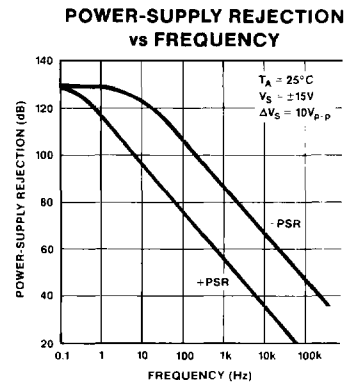
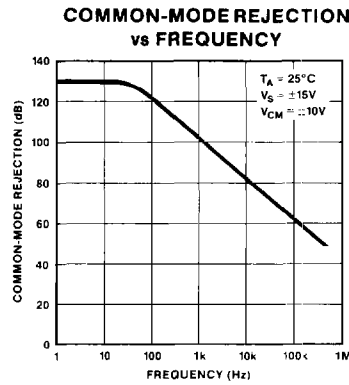
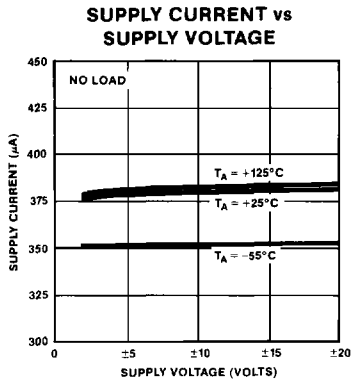

TYPICAL PERFORMANCE CHARACTERISTICS

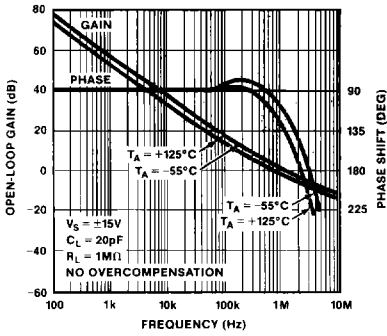
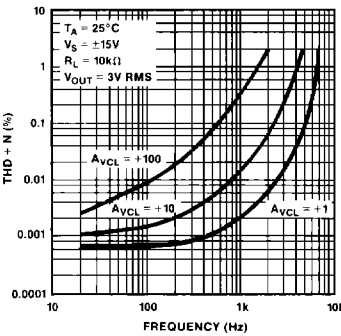
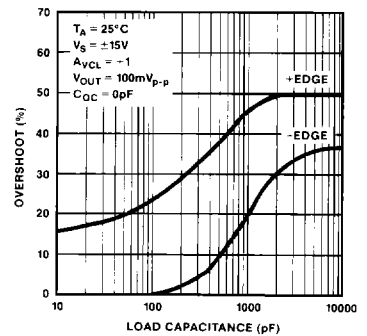
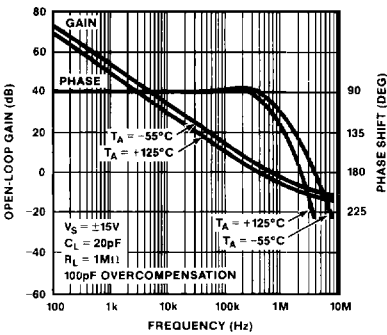
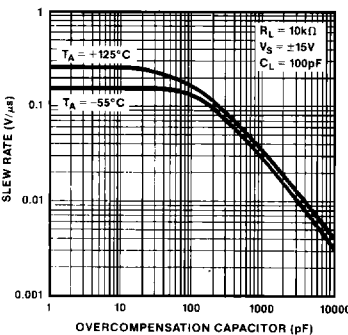
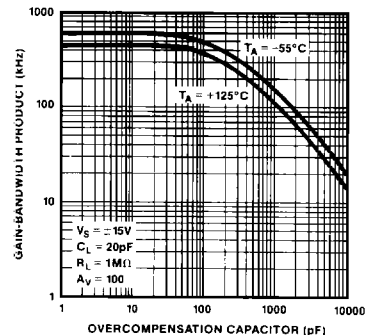
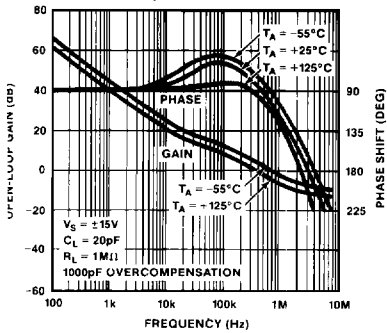
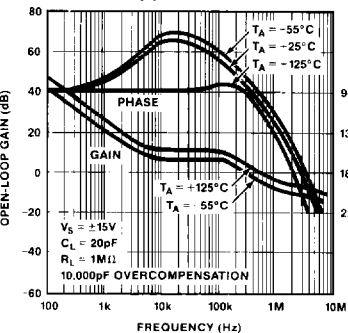
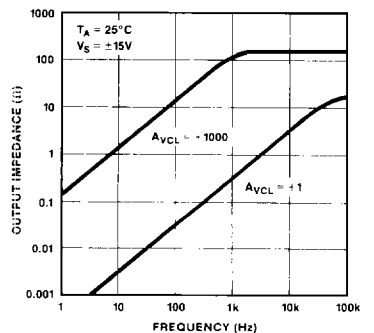
OPEN-LOOP GAIN, PHASE vs FREQUENCY (C_{OC} = 0pF)

TOTAL HARMONIC DISTORTION PLUS NOISE vs FREQUENCY

SMALL-SIGNAL OVERSHOOT vs CAPACITIVE LOAD

OPEN-LOOP GAIN, PHASE vs FREQUENCY (C_{OC} = 100pF)

SLEW RATE vs OVERCOMPENSATION

GAIN-BANDWIDTH PRODUCT vs OVERCOMPENSATION

OPEN-LOOP GAIN, PHASE vs FREQUENCY (C_{OC} = 1000pF)

OPEN-LOOP GAIN, PHASE vs FREQUENCY (C_{OC} = 10,000pF)

CLOSED-LOOP OUTPUT RESISTANCE vs FREQUENCY

OPERATIONAL AMPLIFIERS/BUFFERS

APPLICATIONS INFORMATION

The PM-1012 is an ideal amplifier for general-purpose applications where precision is critical and power dissipation must be minimized. Excellent input specifications and a wide supply-voltage range allows the PM-1012 to be stocked as a standard amplifier for a wide variety of circuits. Overall performance of the PM-1012 is similar to, and in many respects better than traditional amplifiers such as the OP-07, and the PM-1012 will directly upgrade these sockets.

Extremely low bias current over the full military temperature range makes the PM-1012 attractive for use in sample-and-hold amplifiers, peak detectors, and log amplifiers that must operate over a wide temperature range. Balancing input resistances is not necessary with the PM-1012. Offset voltage and TCV_{OS} are degraded only minimally by high source resistance, even when unbalanced.

The input pins of the PM-1012 are protected against large differential voltages by back-to-back diodes. Current-limiting resistors are not used so that low-noise performance is maintained. If differential voltages above $\pm 1V$ are expected at the inputs, series resistors must be used to limit the current flow to a maximum of 10mA. Common-mode voltages at the inputs are not restricted, and may vary over the full range of the supply voltages used.

The PM-1012 requires very little operating headroom about the supply rails, and is specified for operation with supplies as low as $\pm 2V$. Typically, the common-mode range extends to within one volt of either rail. The output typically swings to within one volt of the rails when using a 10k Ω load.

Offset nulling is achieved utilizing the same circuitry as an OP-07. A potentiometer between 5k Ω and 100k Ω is connected between pins 1 and 8 with the wiper connected to the positive supply. The trim range is between 300 μV and 850 μV , depending upon the internal trimming of the device.

FIGURE 1: Optional Input Offset Voltage Nulling and Over-compensation Circuits

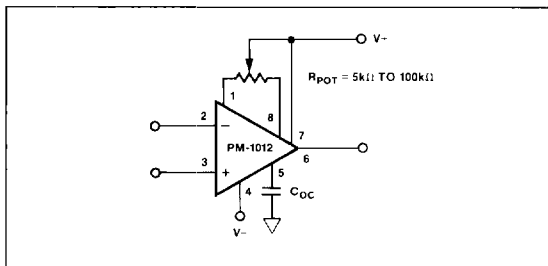
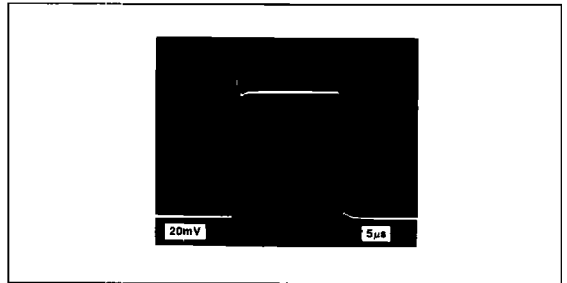

FIGURE 2: Small Signal Transient Response
($C_{LOAD} = 100pF$, $A_{VCL} = +1$)



AC PERFORMANCE

The PM-1012's AC characteristics are highly stable over its full operating temperature range. Unity-gain small signal response is shown in Figure 2. Extremely tolerant of capacitive loading on the output, the PM-1012 displays excellent response even with 1000pF loads (Figure 3). In large-signal applications, the input protection diodes effectively short the input to the output during the transients if the amplifier is connected in the usual unity-gain configuration. The output enters short-circuit current limit, with the flow going through the protection diodes. Improved large-signal transient response is obtained by using a feedback resistor between the output and the inverting input. Figure 4 shows the large-signal response of the PM-1012 in unity-gain with a 10k Ω feedback resistor. The unity-gain follower circuit is shown in Figure 5.

FIGURE 3: Small-Signal Transient Response
($C_{LOAD} = 1000pF$, $A_{VCL} = +1$)

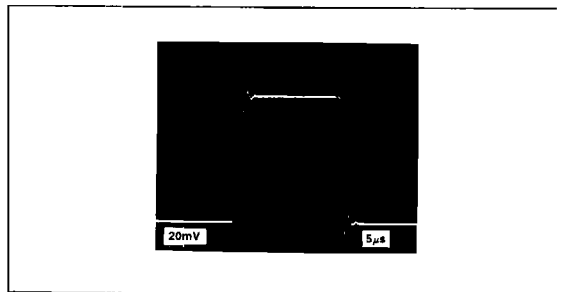
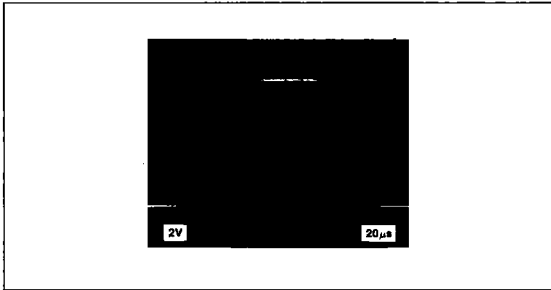
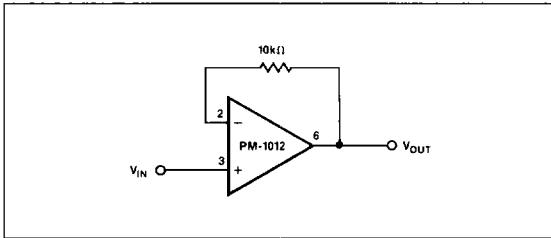

FIGURE 4: Large Signal Transient Response ($A_{VCL} = +1$)

FIGURE 5: Unity-Gain Follower

USING OVERCOMPENSATION

The overcompensation pin provides flexibility for shaping AC response to an application's requirements. This pin may be used to increase the stability of circuits with large capacitive loads or gain in the feedback loop, or for feedforward compensation to improve slew rate.

Figure 6 shows feedforward compensation for a unity-gain follower. Slew rate is increased to close to $10V/\mu s$ in this circuit. Load driving ability is adversely affected by this compensation, and gain errors are incurred even with $10k\Omega$ loads. Feedforward compensation should be used with care to ensure that significant errors are not introduced.

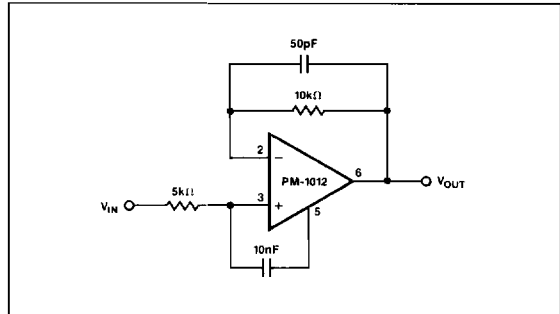
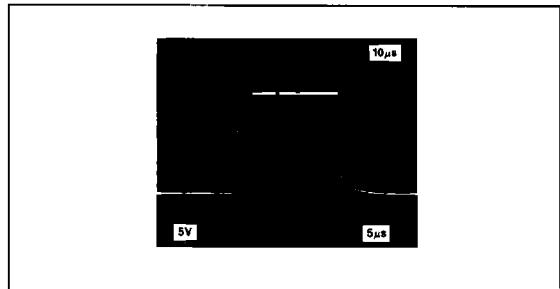
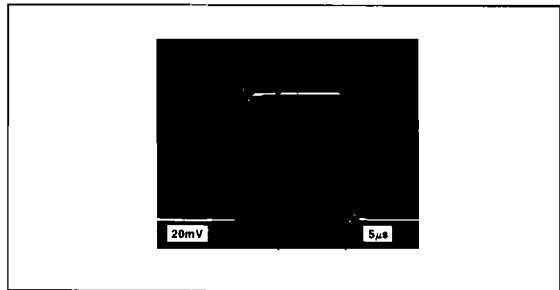
Capacitive load driving ability is improved by using overcompensation in the circuit of Figure 1. The signal response in Figure 8 was made under the same conditions as Figure 3, except for the addition of a $220pF$ capacitor placed between pin 5 and ground. Overcompensation in this manner increases phase margin and decreases the gain-bandwidth product of the amplifier.

FIGURE 6: Follower Feedforward Compensation

FIGURE 7: Feedforward Compensation Transient Response

FIGURE 8: Small Signal Transient Response with Overcompensation ($C_{LOAD} = 1000pF$, $A_{VCL} = +1$, $C_{OC} = 220pF$)

GUARDING AND SHIELDING

To maintain the extremely high input impedances of the PM-1012, care must be taken in circuit board layout and manufacturing. Board surfaces must be kept scrupulously clean and free of moisture. Conformal coating is recommended to provide a humidity barrier. Even a clean PC board can have 100pA of leakage currents between adjacent traces, so that guard rings should be used around the inputs. Guard traces are operated at a voltage close to that on the inputs, so that leakage currents become minimal. In noninverting applications, the guard ring should be connected to the common-mode voltage at the inverting input (pin 2). In inverting applications, both inputs remain at ground, so that the guard trace should be grounded. Guard traces should be made on both sides of the circuit board.

High impedance circuitry is extremely susceptible to RF pickup, line-frequency hum, and radiated noise from switching

power-supplies. Enclosing sensitive analog sections within grounded shields is generally necessary to prevent excessive noise pickup. Twisted-pair cable will aid in rejection of line-frequency hum.

A precision absolute-value current-to-voltage converter that operates over a wide temperature range is shown in Figure 10. The PM-1012's low bias current over its full common-mode and temperature ranges ensures a high degree of linearity in this circuit. The PM-1012 acts as an inverting or noninverting current-to-voltage converter, depending upon the polarity of the input. While the input is sinking current, the voltage is developed across the resistor at the noninverting input, hence sources must have reasonable compliance. While the input is sourcing current, it remains at one diode drop below ground; compliance of a current sink at the input is less critical. If 1M Ω resistors are used, the circuit will output 1V/ μ A of input current.

FIGURE 9: Guard Ring Layout and Connections

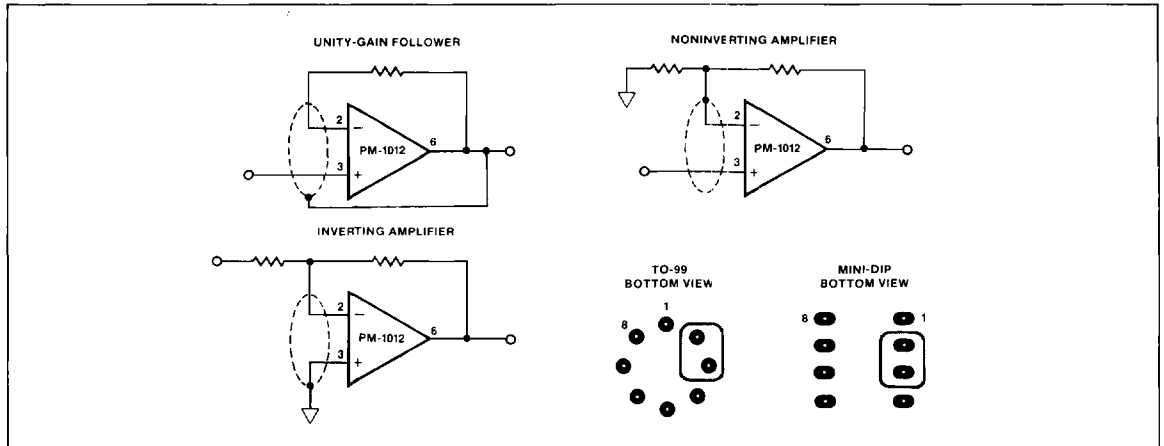

FIGURE 10: Precision Absolute-Value Current-to-Voltage Converter

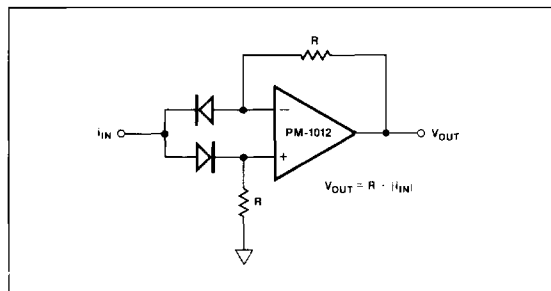
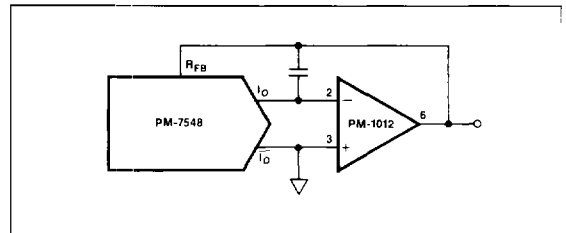

FIGURE 11: DAC Output Amplifier



The PM-1012 is an excellent amplifier for CMOS and bipolar DACs where high linearity is critical. Its low bias current and offset voltage ensures that linearity errors are negligible, even when operating with high resolution DACs and low reference voltages. A capacitor should be placed in the feedback loop of the amplifier to cancel the pole formed by the additional input capacitance from the DAC. Twenty to forty picofarads is usually adequate for compensation with CMOS or bipolar DACs.

The logarithmic amplifier in Figure 12 eliminates thermal drift caused by temperature dependencies of the logging transistors by maintaining a monolithic quad matched transistor at a predetermined temperature. The MAT-04 has four transistors laid-out at the corners of a square die. Two transistors across a diagonal are used for logging elements. One of the remaining transistors is used as a heater to maintain a constant chip

temperature, and the remaining transistor, diagonally opposite to the heater, is used as a temperature sensor.

The OP-90 servo amplifier uses thermal feedback to set the temperature of the die. The base-to-emitter voltage of Q2 is maintained at the level set by the resistive divider from the REF-01, by controlling the current flowing through Q4. Although Q4 may operate at higher than the MAT-04's rated levels, this does not degrade operation since the characteristics of the heater transistor are non-critical. For best thermal regulation, the MAT-04 package should be encased in insulation. Urethane foam used for housing insulation is excellent for this purpose.

Gain is trimmed using the 2k Ω potentiometer. The zero-crossing point is adjusted by changing the value of R_{REF}. Input scaling may be changed by varying resistor R_{IN}.

FIGURE 12: Logarithmic Amplifier with Heated Logging Transistors

