

# High Power Synchronous DC/DC Controller

## FEATURES

- **High Voltage: Operation Up to 60V Max**
- **High Current: Dual N-Channel Synchronous Drive Handles Up to 10,000pF Gate Capacitance**
- Programmable Average Load Current Limiting
- 5V Reference Output with 10mA External Loading Capability
- Programmable Fixed Frequency Synchronizable Current Mode Operation Up to 150kHz
- Undervoltage Lockout with Hysteresis
- Programmable Start Inhibit for Power Supply Sequencing and Protection
- Adaptive Nonoverlapping Gate Drive Prevents Shoot-Through

## APPLICATIONS

- 48V Telecom Power Supplies
- Personal Computers and Peripherals
- Distributed Power Converters
- Industrial Control Systems
- Lead-Acid Battery Backup Systems
- Automotive and Heavy Equipment

## DESCRIPTION

The LT<sup>®</sup>1339 is a high power synchronous current mode switching regulator controller. The IC drives dual N-channel MOSFETs to create a single IC solution for high power DC/DC converters in applications up to 60V.

The LT1339 incorporates programmable average current limiting, allowing accurate limiting of DC load current independent of inductor ripple current. The IC also incorporates user-adjustable slope compensation for minimization of magnetics at duty cycles up to 90%.

The LT1339 timing oscillator operating frequency is programmable and can be synchronized up to 150kHz. Minimum off-time operation provides main switch protection. The IC also incorporates a soft start feature that is gated by both shutdown and undervoltage lockout conditions.

An output phase reversal pin allows flexibility in configuration of converter types, including inverting and negative topologies.

 LTC and LT are registered trademarks of Linear Technology Corporation

## TYPICAL APPLICATION

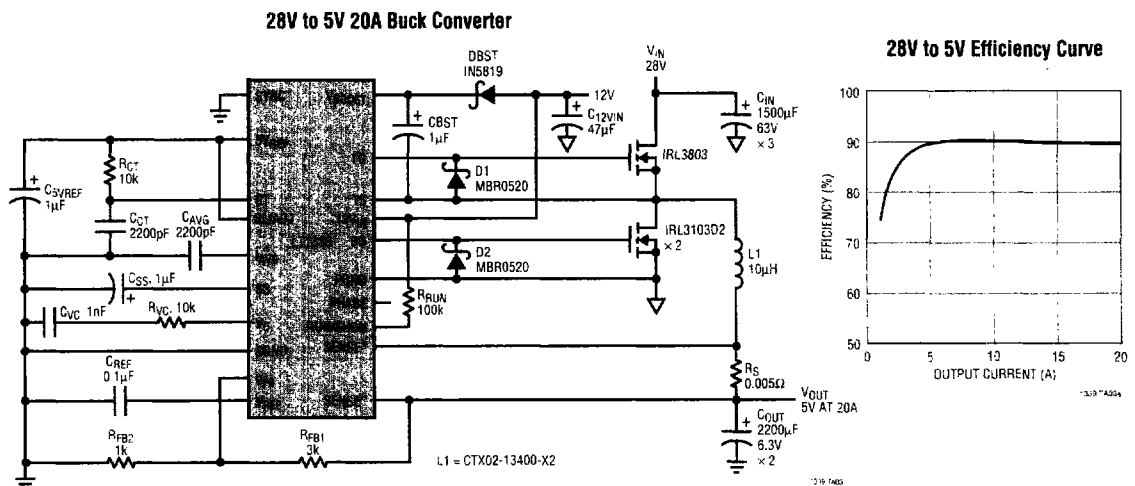

## ABSOLUTE MAXIMUM RATINGS

(Note 1)

### Supply Voltages

Power Supply Voltage ( $12V_{IN}$ ) ..... -0.3V to 20V

Topside Supply Voltage ( $V_{BOOST}$ )

$V_{TS} - 0.3V$  to  $V_{TS} + 20V$  ( $V_{MAX} = 75V$ )

Topside Reference Pin Voltage (TS) ..... -0.3V to 60V

### Input Voltages

Sense Amplifier Input Common Mode ... -0.3V to 60V

RUN/SHDN Pin Voltage ..... -0.3V to  $12V_{IN}$

All Other Inputs ..... -0.3V to 7V

### Maximum Currents

5V Reference Output Current ..... 65mA

### Maximum Temperatures

Operating Ambient Temperature Range

LT1339C ..... 0°C to 70°C

LT1339I ..... -40°C to 85°C

Storage Temperature Range ..... -65°C to 150°C

Lead Temperature (Soldering, 10 sec) ..... 300°C

## PACKAGE/ORDER INFORMATION

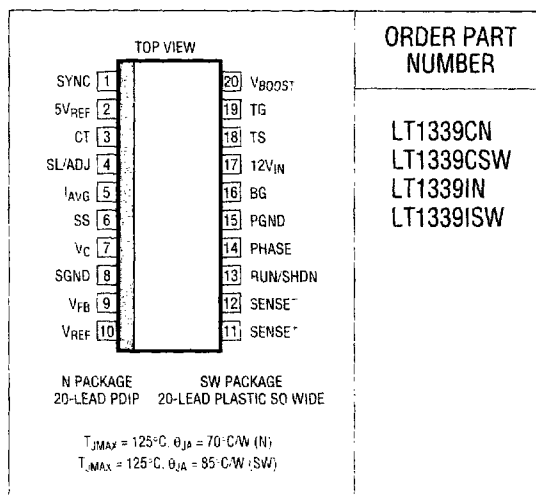

ORDER PART NUMBER

LT1339CN  
 LT1339CSW  
 LT1339IN  
 LT1339ISW

Consult factory for Military grade parts

4

## ELECTRICAL CHARACTERISTICS

$12V_{IN} = V_{BOOST} = 12V$ ,  $V_C = 2V$ ,  $TS = 0V$ ,  $V_{FB} = V_{REF} = 1.25V$ ,  $C_{TG} = C_{BG} = 3000pF$ ,  $T_A = 25^{\circ}C$  unless otherwise noted.

SYMBOL	PARAMETER	CONDITIONS	MIN	TYP	MAX	UNITS	
<b>Supply and Protection</b>							
$I_{12VIN}$	DC Active Supply Current (Note 2)		●	14	20	mA	
	DC Standby Supply Current	$V_{RUN} < 0.5V$	●	65	110	$\mu A$	
$I_{BOOST}$	DC Active Supply Current (Note 2)			2.2		mA	
	DC Standby Supply Current	$V_{RUN} < 0.5V$		0		$\mu A$	
$V_{RUN/SHDN}$	Shutdown Rising Threshold		●	1.15	1.25	1.35	V
$V_{SSHYST}$	Shutdown Threshold Hysteresis			15		mV	
$I_{SS}$	Soft Start Charge Current		●	4	8	20	$\mu A$
$V_{UVLO}$	Undervoltage Lockout Threshold - Falling		●	8.20	9.00	9.75	V
	Undervoltage Lockout Threshold - Rising		●		9.35	9.95	V
	Undervoltage Lockout Hysteresis		●	200	350		mV
<b>5V Reference</b>							
$V_{REF5}$	5V Reference Voltage	Line, Load and Temperature	●	4.75	5.00	5.25	V
	5V Reference Line Regulation	$10V \leq 12V_{IN} \leq 15V$	●		3	5	mV/V
$I_{REF5}$	5V Reference Load Range - DC		●			10	mA
	5V Reference Load Range - Pulse		●			20	mA
	5V Reference Load Regulation	$0 \leq I_{REF5} \leq 20mA$	●		-1.25	-2	V/A
$I_{SC}$	5V Reference Short-Circuit Current					45	mA

## ELECTRICAL CHARACTERISTICS

$12V_{IN} = V_{BOOST} = 12V$ ,  $V_C = 2V$ ,  $T_S = 0V$ ,  $V_{FB} = V_{REF} = 1.25V$ ,  $C_{TG} = C_{BG} = 3000pF$ ,  $T_A = 25^\circ C$  unless otherwise noted.

SYMBOL	PARAMETER	CONDITIONS	MIN	TYP	MAX	UNITS	
<b>Error Amplifier</b>							
$V_{FB}$	Error Amplifier Reference Voltage	Measured at Feedback Pin	●	1.242	1.250	1.258	V
			●	1.235		1.265	V
$I_{FB}$	Feedback Input Current	$V_{FB} = V_{REF}$	●	0.1	0.5	1.0	$\mu A$
$g_m$	Error Amplifier Transconductance		●	1200	2000	3200	$\mu mho$
$A_V$	Error Amplifier Voltage Gain		●	1500	3000		V/V
$I_{VC}$	Error Amplifier Source Current Error Amplifier Sink Current	$V_{FB} - V_{REF} = 500mV$	●	200	275		$\mu A$
			●	280	400		$\mu A$
$V_{VC}$	Absolute $V_C$ Clamp Voltage	Measured at $V_C$ Pin			3.5		V
$V_{SENSE}$	Peak Current Limit Threshold Average Current Limit Threshold (Note 4)	Measured at Sense Inputs Measured at Sense Inputs	●	170	190		mV
			●	110	120	130	mV
$V_{I_{AVG}}$	Average Current Limit Threshold	Measured at $I_{AVG}$ Pin			2.5		V
<b>Current Sense Amplifier</b>							
$A_V$	Amplifier DC Gain	Measured at $I_{AVG}$ Pin			15		V/V
$V_{OS}$	Amplifier Input Offset Voltage	$2V < V_{CMSENSE} < 60V$ , $SENSE^+ - SENSE^- = 5mV$	●	0.1			mV
$I_B$	Input Bias Current	Sink ( $V_{CMSENSE} > 5V$ ) Source ( $V_{CMSENSE} = 0V$ )	●		45	75	$\mu A$
			●		700	1200	$\mu A$
<b>Oscillator</b>							
$f_O$	Operating Frequency, Free Run Frequency Programming Error (Note 3)	$f_O \leq 150kHz$	●			150	kHz
			●	-5		5	%
$I_{CT}$	Timing Capacitor Discharge Current	LT1339C LT1339I	●	2.20	2.50	2.75	mA
			●	2.10	2.50	2.75	mA
$V_{SYNC}$	SYNC Input Threshold	Rising Edge	●	0.8		2.0	V
$f_{SYNC}$	SYNC Frequency Range	$f_{SYNC} \leq 150kHz$	●	$f_O$		1.4 $f_C$	
<b>Output Drivers</b>							
$V_{TG\ BG}$	Undervoltage Output Clamp Standby Mode Output Clamp	$12V_{IN} \leq 8V$ $V_{RUN} < 0.5V$	●		0.4	0.7	V
			●			0.1	V
$V_{TG}$	Top Gate On Voltage Top Gate Off Voltage		●	11.0	11.9	12.0	V
			●		0.4	0.7	V
$t_{TGR}$	Top Gate Rise Time		●	130	200		ns
$t_{TGF}$	Top Gate Fall Time		●	60	140		ns
$V_{BG}$	Bottom Gate On Voltage Bottom Gate Off Voltage		●	11.0	11.9	12.0	V
			●		0.4	0.7	V
$t_{BGR}$	Bottom Gate Rise Time		●	70	200		ns
$t_{BGF}$	Bottom Gate Fall Time		●	60	140		ns

The ● denotes specifications which apply over the full operating temperature range.

**Note 1:** Absolute maximum ratings are those values beyond which the life of a device may be impaired.

**Note 2:** Supply current specification does not include external FET gate charge currents. Actual supply currents will be higher and vary with operating frequency, operating voltages and the type of external FETs used. See Application Information section.

**Note 3:** Test condition:  $R_{CT} = 16.9k$ ,  $C_{CT} = 1000pF$

**Note 4:** Test Condition:  $V_{CMSENSE} = 10V$ .

**TYPICAL PERFORMANCE CHARACTERISTICS**

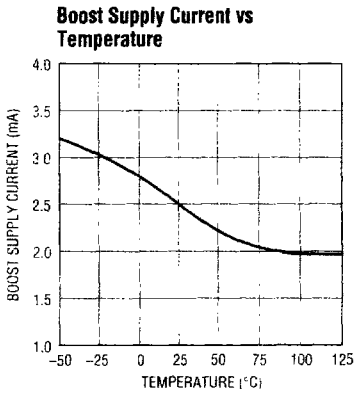

1339-001

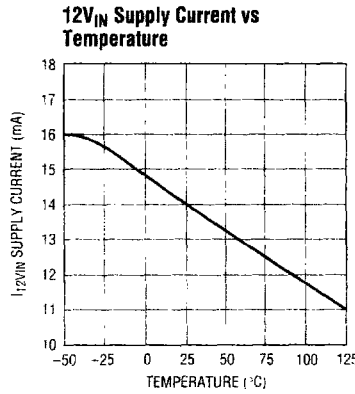

1339-002

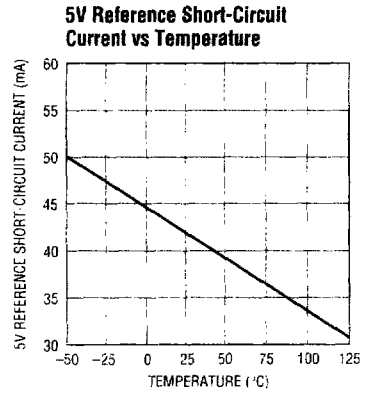

1339-003

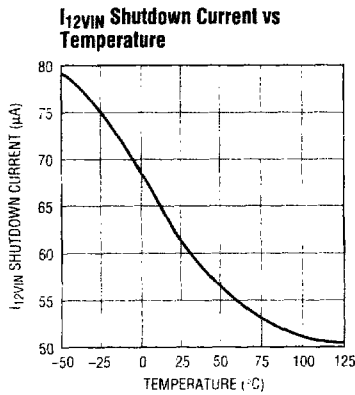

1339-004

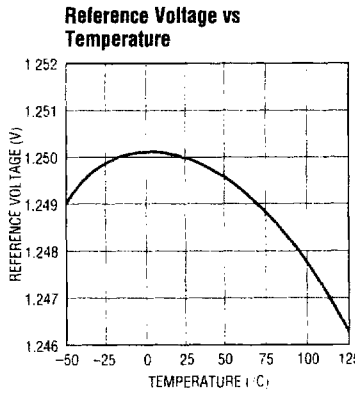

1339-005

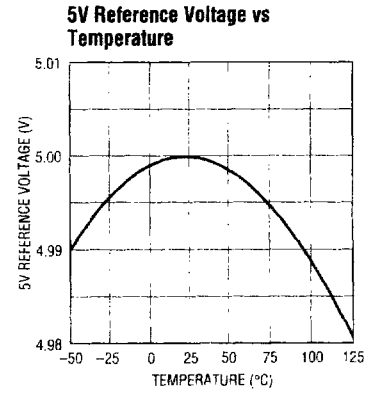

1339-006

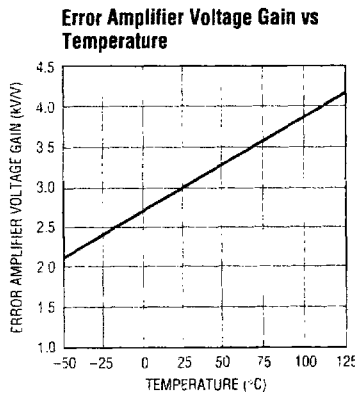

1339-007

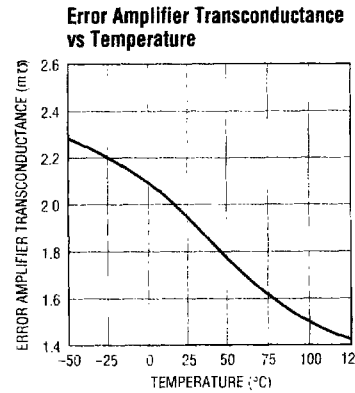

1339-008

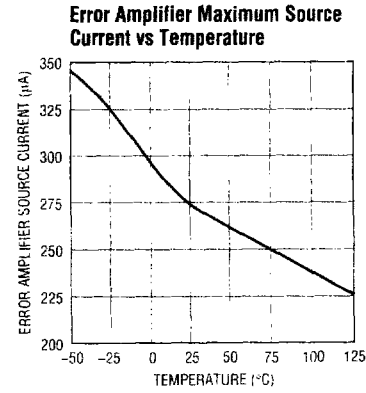

1339-009

4

TYPICAL PERFORMANCE CHARACTERISTICS

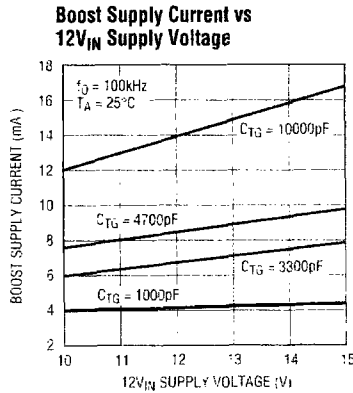
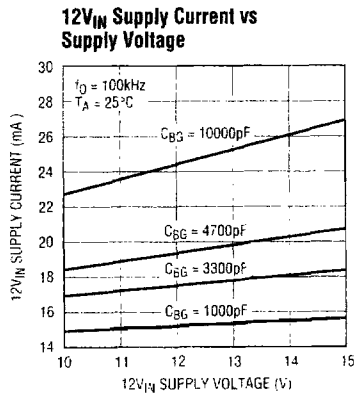
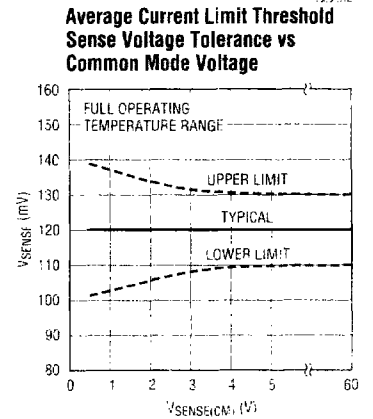
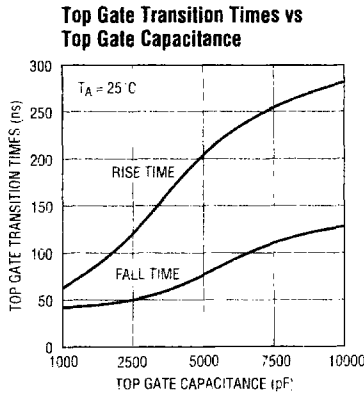
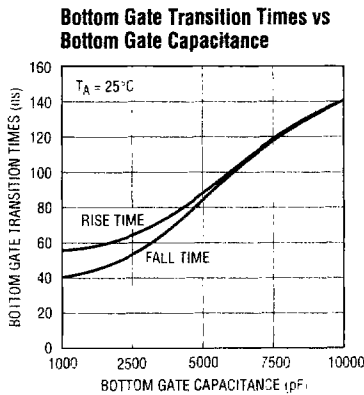
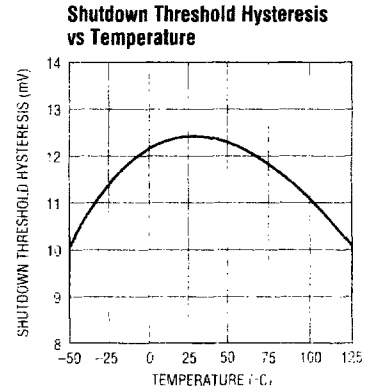
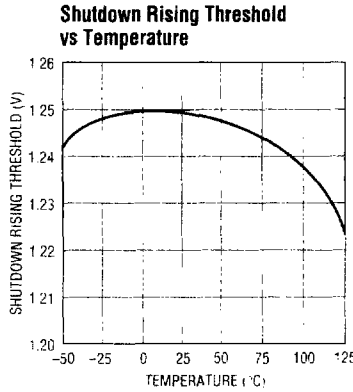
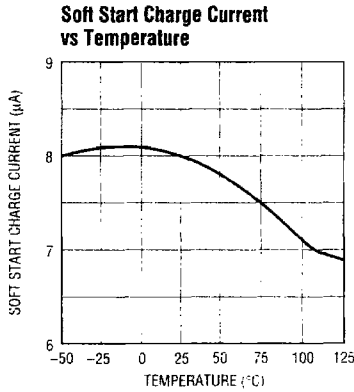

**TYPICAL PERFORMANCE CHARACTERISTICS**

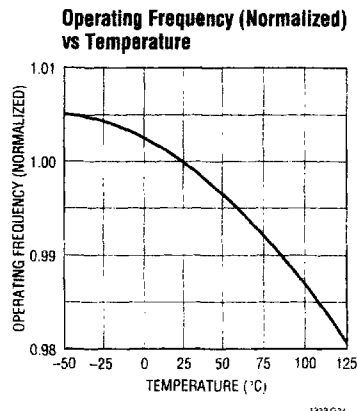
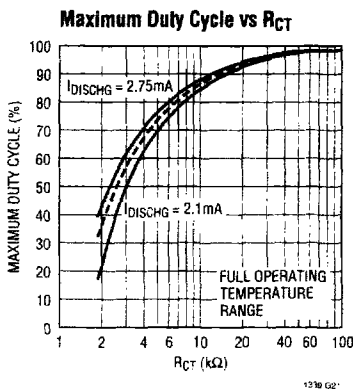
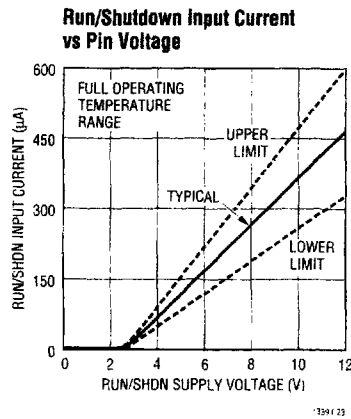
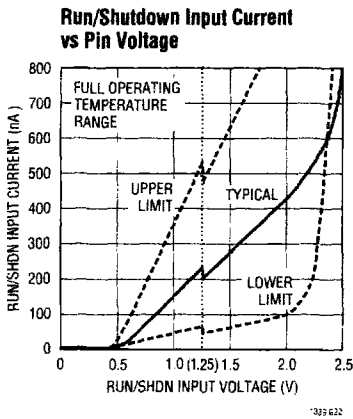
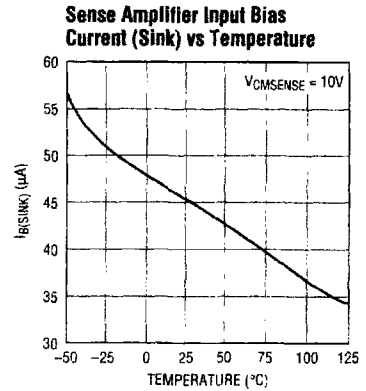
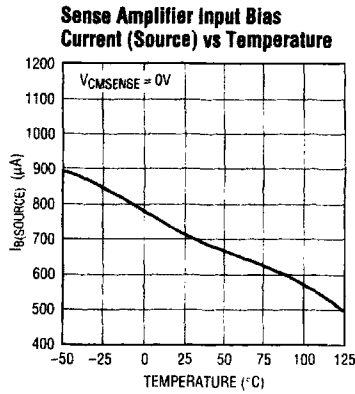
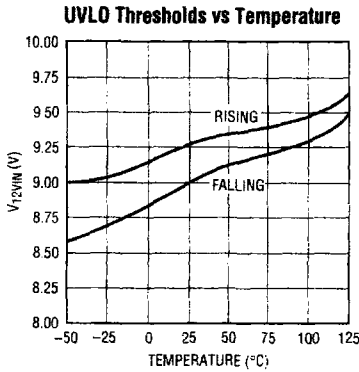

4

## PIN FUNCTIONS

**SYNC (Pin 1):** Oscillator Synchronization Pin with TTL-Level Compatible Input. Input drives internal rising edge triggered one-shot; sync signal on/off times should be  $\geq 1\mu\text{s}$  (10% to 90% DC at 100kHz). Does not contain internal pull-up. Connect to SGND if not used.

**5V<sub>REF</sub> (Pin 2):** 5V Output Reference. Allows connection of external loads up to 10mA DC. (Reference is not available in shutdown.) Typically bypassed with  $1\mu\text{F}$  capacitor to SGND.

**CT (Pin 3):** Oscillator Timing Pin. Connect a capacitor ( $C_{CT}$ ) to ground and a pull-up resistor ( $R_{CT}$ ) to the 5V<sub>REF</sub> supply. Typical values are  $C_T = 1000\text{pF}$  and  $10\text{k} \leq R_{CT} \leq 30\text{k}$ .

**SL/ADJ (Pin 4):** Slope Compensation Adjustment. Allows increased slope compensation for certain high duty cycle applications. Resistive loading of the pin increases effective slope compensation. A resistor divider from the 5V<sub>REF</sub> pin can tailor the onset of additional slope compensation to specific regions in each switch cycle. Pin can be floated or connected to 5V<sub>REF</sub> if no additional slope compensation is required. (See Applications Information section for slope compensation details.)

**I<sub>AVG</sub> (Pin 5):** Average Current Limit Integration. Frequency response characteristic is set using the 50k $\Omega$  output impedance and external capacitor to ground. Averaging roll-off typically set at 1 to 2 orders of magnitude under switching frequency. (Typical capacitor value  $\sim 1000\text{pF}$  for  $f_0 = 100\text{kHz}$ .) Shorting this pin to SGND will disable the average current limit function.

**SS (Pin 6):** Soft Start. Generates ramping threshold for regulator current limit during start-up and after UVLO event by sourcing about  $10\mu\text{A}$  into an external capacitor.

**V<sub>C</sub> (Pin 7):** Error Amplifier Output. RC load creates dominant compensation in power supply regulation feedback loop to provide optimum transient response. (See Applications Information section for compensation details.)

**SGND (Pin 8):** Small-Signal Ground. Connect to negative terminal of C<sub>OUT</sub>.

**V<sub>FB</sub> (Pin 9):** Error Amplifier Inverting Input. Used as voltage feedback input node for regulator loop. Pin sources about  $0.5\mu\text{A}$  DC bias current to protect from an open feedback path condition.

**V<sub>REF</sub> (Pin 10):** Bandgap Generated Voltage Reference Decoupling. Connect a capacitor to signal ground. (Typical capacitor value  $\sim 0.1\mu\text{F}$ .)

**SENSE<sup>+</sup> (Pin 11):** Current Sense Amplifier Inverting Input. Connect to most positive (DC) terminal of current sense resistor.

**SENSE<sup>-</sup> (Pin 12):** Current Sense Amplifier Noninverting Input. Connect to most negative (DC) terminal of current sense resistor.

**RUN/SHDN (Pin 13):** Precision Referenced Shutdown. Can be used as logic level input for shutdown control or as an analog monitor for input supply undervoltage protection, etc. IC is enabled when RUN/SHDN pin rising edge exceeds 1.25V. About 15mV of hysteresis helps assure stable mode switching. All internal functions are disabled in shutdown mode. If this function is not desired, connect RUN/SHDN to 12V<sub>IN</sub> (typically through a 100k resistor). See Applications Information section.

**PHASE (Pin 14):** Output Driver Phase Control. If Pin 14 is not connected (floating), the topside driver operates the main switch, with the bottom side driver operating the synchronous switch. Shorting Pin 14 to ground reverses the roles of the output drivers. PHASE is typically shorted to ground for inverting and boost configurations. Positive Buck configuration requires the PHASE pin to float. See Applications Information section.

**PGND (Pin 15):** Power Ground. References the bottom side output switch and internal driver control circuits. Connect with low impedance trace to V<sub>IN</sub> decoupling capacitor negative (ground) terminal.

**BG (Pin 16):** Bottom Side Output Driver. Connects to gate of bottom side external power FET.

**12V<sub>IN</sub> (Pin 17):** 12V Power Supply Input. Bypass with at least  $1\mu\text{F}$  to PGND.

**TS (Pin 18):** Boost Output Driver Reference. Typically connects to source of topside external power FET and inductive switch node.

**TG (Pin 19):** Topside (Boost) Output Driver. Connects to gate of topside external power FET.

**V<sub>BOOST</sub> (Pin 20):** Topside Power Supply. Bootstrapped via  $1\mu\text{F}$  capacitor tied to switch node (Pin 18) and Schottky diode connected to the 12V<sub>IN</sub> supply.

**FUNCTIONAL BLOCK DIAGRAM**

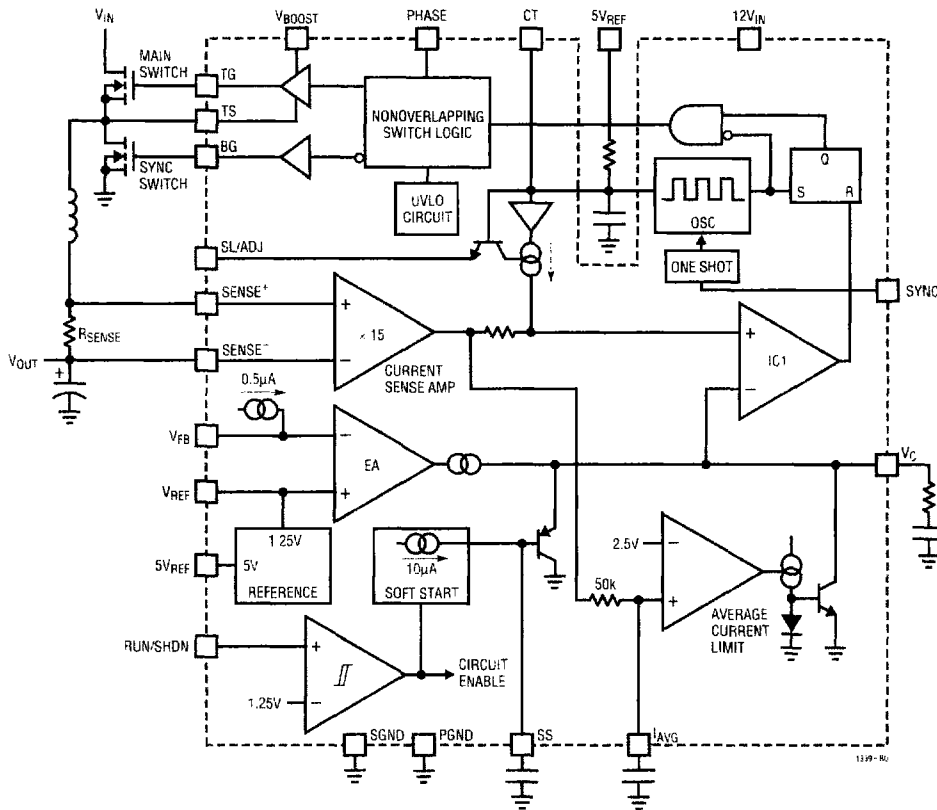

4

**OPERATION** (Refer to Functional Block Diagram)

**Basic Control Loop**

The LT1339 uses a constant frequency, current mode synchronous architecture. The timing of the IC is provided through an internal oscillator circuit, which can be synchronized to an external clock, programmable to operate at frequencies up to 150kHz. The oscillator creates a modified sawtooth wave at its timing node (CT) with a slow charge, rapid discharge characteristic.

During typical positive Buck operation, the main switch MOSFET is enabled at the start of each oscillator cycle. The main switch stays enabled until the current through the switched inductor, sensed via the voltage across a series

sense resistor ( $R_{SENSE}$ ), is sufficient to trip the current comparator (IC1) and, in turn, reset the RS latch. When the RS latch resets, the main switch is disabled, and the synchronous switch MOSFET is enabled. Shoot-through prevention logic prohibits enabling of the synchronous switch until the main switch is fully disabled. If the current comparator threshold is not obtained throughout the entire oscillator charge period, the RS latch is bypassed and the main switch is disabled during the oscillator discharge time. This "minimum off time" assures adequate charging of the bootstrap supply, protects the main switch, and is typically about 1µs.



## OPERATION (Refer to Functional Block Diagram)

The current comparator trip threshold is set on the  $V_C$  pin, which is the output of a transconductance amplifier, or error amplifier (EA). The error amplifier integrates the difference between a feedback voltage (on the  $V_{FB}$  pin) and an internal bandgap generated reference voltage of 1.25V, forming a signal that represents required load current. If the supplied current is insufficient for a given load, the output will droop, thus reducing the feedback voltage. The error amplifier forces current out of the  $V_C$  pin, increasing the current comparator threshold. Thus, the circuit will servo until the provided current is equal to the required load and the average output voltage is at the value programmed by the feedback resistors.

### Average Current Limit

The output of the sense amplifier is monitored by a single pole integrator comprised of an external capacitor on the  $I_{AVG}$  pin and an internal impedance of approximately 50k $\Omega$ . If this averaged value signal exceeds a level corresponding to 120mV across the external sense resistor, the current comparator threshold is clamped and cannot continue to rise in response to the error amplifier. Thus, if average load current requirements exceed 120mV/ $R_{SENSE}$ , the supply will current limit and the output voltage will fall out of regulation. The average current limit circuit monitors the sense amplifier output without slope compensation or ripple current contributions, therefore the average load current limit threshold is unaffected by duty cycle.

### Undervoltage Lockout

The LT1339 employs an undervoltage lockout circuit (UVLO) that monitors the 12V supply rail. This circuit disables the output drive capability of the LT1339 if the 12V supply drops below about 9V. Unstable mode switching is prevented through  $\approx$ 350mV of UVLO threshold hysteresis.

### Adaptive Nonoverlapping Output Stage

The FET driver output stage implements adaptive nonoverlapping control. This circuitry maintains dead time independent of the type, size or operating conditions of the switch elements. The control circuit monitors the

output gate drive signals, insuring that the switch gate (being disabled) is fully discharged before enabling the other switch driver.

### Shutdown

The LT1339 can be put into low current shutdown mode by pulling the RUN/SHDN pin low, disabling all circuit functions. The shutdown threshold is a bandgap referred voltage of 1.25V typical. Use of a precision threshold on the shutdown circuit enables use of this pin for undervoltage protection of the  $V_{IN}$  supply and/or power supply sequencing.

### Soft Start

The LT1339 incorporates a soft start function that operates by slowly increasing the internal current limit. This limit is controlled by clamping the  $V_C$  node to a low voltage that climbs with time as an external capacitor on the SS pin is charged with about 10 $\mu$ A of current. This forces a graceful climb of output current capability and thus a graceful increase in output voltage until steady-state regulation is achieved. The soft start timing capacitor is clamped to ground during shutdown and during undervoltage lockout, yielding a graceful output recovery from either condition.

### 5V Internal Reference

Power for the oscillator timing elements and most other internal LT1339 circuits is derived from an internal 5V reference, accessible at the 5V<sub>REF</sub> pin. This supply pin can be loaded with up to 10mA DC (20mA pulsed) for convenient biasing of local elements such as control logic, etc.

### Slope Compensation

For duty cycles greater than 50%, slope compensation is required to prevent current mode duty cycle instability in the regulator control loop. The LT1339 employs internal slope compensation that is adequate for most applications. However, if additional slope compensation is desired, it is available through the SL/ADJ pin. Excessive slope compensation will cause reduction in maximum load current capability and therefore is not desirable.

## APPLICATIONS INFORMATION

### R<sub>SENSE</sub> Selection for Output Current

R<sub>SENSE</sub> generates a voltage that is proportional to the inductor current for use by the LT1339 current sense amplifier. The value of R<sub>SENSE</sub> is based on the required load current. The average current limit function has a typical threshold of 120mV/R<sub>SENSE</sub>, or:

$$R_{SENSE} = 120\text{mV}/I_{LIMIT}$$

Operation with V<sub>SENSE</sub> common mode voltage below 4.5V may slightly degrade current limit accuracy. See Average Current Limit Threshold Tolerance vs Common Mode Voltage curve in the Typical Performance Characteristics section for more information.

### Output Voltage Programming

Output voltage is programmed through a resistor feedback network to V<sub>FB</sub> (Pin 9) on the LT1339. This pin is the inverting input of the error amplifier, which is internally referenced to 1.25V. The divider is ratioed to provide 1.25V at the V<sub>FB</sub> pin when the output is at its desired value.

The output voltage is thus set following the relation:

$$V_{OUT} = 1.25(1 + R2/R1)$$

when an external resistor divider is connected to the output as shown in Figure 1.

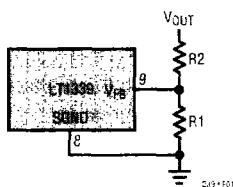

Figure 1. Programming LT1339 Output Voltage

### Oscillator Components R<sub>CT</sub> and C<sub>CT</sub>

The LT1339 oscillator creates a modified sawtooth wave at its timing node (CT) with a slow charge, rapid discharge characteristic. The rapid discharge time corresponds to the minimum off-time of the PWM controller. This limits maximum duty cycle (DC<sub>MAX</sub>) to:

$$DC_{MAX} = 1 - (t_{DISCH})(f_0)$$

The oscillator sawtooth amplitude is about 1.7V and discharge current is typically 2.5mA. Taking into account

the current supplied by the charging resistor (R<sub>CT</sub>), discharge time can be estimated at 900ns for a typical timing capacitor value of 1000pF. (This value allows > 90% duty cycle operation at 100kHz.)

With a given value of C<sub>CT</sub>, oscillator frequency is determined through selection of the timing resistor R<sub>CT</sub>. The free run charging time for the oscillator is:

$$t_{CHARGE} = (R_{CT})(C_{CT})/1.85$$

A typical operational value of R<sub>CT</sub> = 17k, yielding a free run frequency of about 100kHz.

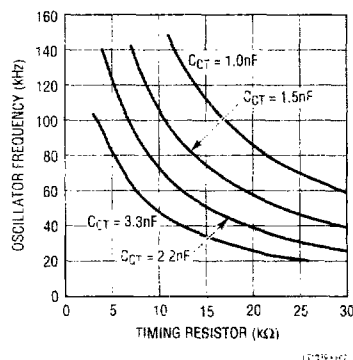

Figure 2. Oscillator Frequency vs R<sub>CT</sub>, C<sub>CT</sub>

### Average Current Limit

The average current limit function is implemented using an external capacitor (C<sub>AVG</sub>) connected from I<sub>AVG</sub> to SGND that forms a single pole integrator with the 50kΩ output impedance of the I<sub>AVG</sub> pin. The integrator corner frequency is typically set 1 to 2 orders of magnitude below the oscillator frequency and follows the relation:

$$f_{-3dB} = (3.2)(10^{-6})/C_{AVG}$$

The average current limit function can be disabled by shorting the I<sub>AVG</sub> pin directly to SGND. In some applications it is theoretically possible for the average current limit circuit to overdrive the error amplifier output (V<sub>C</sub>) beyond the operating range of the current sense comparator. These applications include those where open-loop system operation occurs, such as boost regulators in output short-circuit condition, or in systems with poor signal ground integrity. This overdrive mode can be elimi-

## APPLICATIONS INFORMATION

nated by connecting an external diode between the  $I_{AVG}$  and  $V_C$  pins (anode to  $I_{AVG}$  and cathode to  $V_C$ ). Connection of this diode clamp will have no adverse effects in any system and is recommended. This clamp is required for all boost converter topologies.

### Soft Start Programming

The current control pin ( $V_C$ ) limits inductor current to zero at voltages less than  $\approx 0.7V$ , to full average current limit at  $V_C \approx 2.5V$ , yielding 1.8V over the full regulation range of average load current. The soft start clamp begins at the zero current level of about 0.7V, thus, given the typical soft start charge current of  $10\mu A$  and a soft start timing capacitor  $C_{SS}$ , the start-up delay time to full available average current will be:

$$t_{SS} = (1.8)(10^5)(C_{SS})$$

### Boost Supply

The  $V_{BOOST}$  supply is bootstrapped via an external capacitor. This supply provides gate drive to the topside switch FET. The bootstrap capacitor is charged from  $12V_{IN}$  through a diode when the switch node is pulled low.

The diode reverse breakdown voltage must be greater than  $V_{IN} + 12V_{IN}$ . The bootstrap capacitor should be at least 100 times greater than the total input capacitance of the topside FET. A capacitor in the range of  $0.1\mu F$  to  $1\mu F$  is generally adequate for most applications.

### Shutdown Function—Input Undervoltage Detect and Threshold Hysteresis

The LT1339 RUN/SHDN pin uses a bandgap generated reference threshold of about 1.25V. This precision threshold allows use of the RUN/SHDN pin for both logic-level shutdown applications and analog monitoring applications such as power supply sequencing.

Because an LT1339 controlled converter is a power transfer device, a voltage that is lower than expected on the input supply could require currents that exceed the sourcing capabilities of that supply, causing the system to lock up in an undervoltage state. Input supply start-up protection can be achieved by enabling the RUN/SHDN pin using a resistor divider from the input supply to ground. Setting the divider output to 1.25V when that supply is almost fully

enabled prevents the LT1339 regulator from drawing large currents until the input supply is able to provide the required power.

If additional hysteresis is desired for the enable function, an external feedback resistor can be used from the LT1339 regulator output. If connection to the regulator output is not desired, the  $5V_{REF}$  internal supply pin can be used. Figure 3 shows a resistor connection on a 48V to 5V converter that yields a 40V  $V_{IN}$  start-up threshold for regulator enable and also provides about 10% input referred hysteresis.

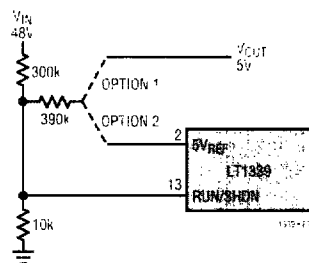

Figure 3. Input Supply Sequencing Programming

The shutdown function can be disabled by connecting the RUN/SHDN pin to the  $12V_{IN}$  rail. This pin is internally clamped to 2.5V through a 20k series input resistance and will therefore draw about 0.5mA when tied directly to 12V. This additional current can be minimized by making the connection through an external resistor (100k is typically used).

When shutting down the LT1339, the RUN/SHDN pin voltage must remain between the shutdown threshold (about 1.13V) and a minimum shutdown control limit voltage (shown in Figure 4) for at least 25 $\mu s$ . If a digital input or fast moving clamp is used, this condition can be achieved by forcing a shutdown control voltage above the minimum limit or by using a simple integrator to increase the fall time of the input signal. A single-pole integrator stage must have a  $\tau \geq 70\mu s$ .

The circuit in Figure 5 is an example of a digital control input clamp. A logic high signal pulls the RUN/SHDN pin above its turn-on threshold through the diode. When a shutdown (logic low) signal is received, the RUN/SHDN

## APPLICATIONS INFORMATION

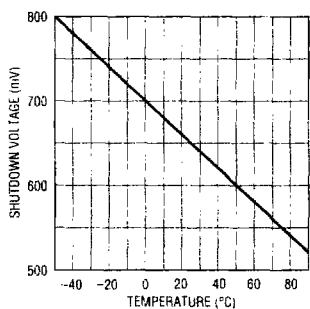

Figure 4. Minimum Shutdown Control Limit vs Temperature

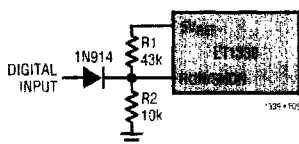

Figure 5. Digital Input Shutdown Level Control

pin is forced to 0.95V via the resistor divider until shutdown is fully established and the 5V<sub>REF</sub> voltage collapses.

The circuit in Figure 6 is an example of a digital control integration stage at the RUN/SHDN input. The integrator has a  $\tau = (10)(10^3) \cdot (10)(10^{-9}) = 100\mu\text{s}$ . This circuit technique, however, delays initiation of controller shutdown about 125 $\mu\text{s}$  from the reception of the shutdown signal (5V to 0V transition).

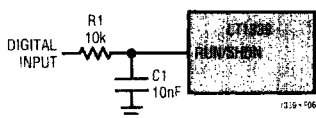

Figure 6. Digital Input Shutdown Integration Control

Figure 7 is an example of an integrator stage coupled with a 48V input power supply sequencing circuit similar to that shown in Figure 3. The integrator stage allows use of an active shutdown clamp for implementation of both user-controlled shutdown and input power supply sequencing protection.

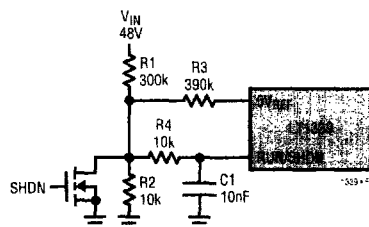

Figure 7. Input Supply Sequencing with User-Controlled Shutdown

### Inductor Selection

The inductor for an LT1339 converter is selected based on output power, operating frequency and efficiency requirements. Generally, the selection of inductor value can be reduced to desired maximum ripple current in the inductor ( $\Delta I$ ). For a buck converter, the minimum inductor value for a desired maximum operating ripple current can be determined using the following relation:

$$L_{MIN} = \frac{(V_{OUT})(V_{IN} - V_{OUT})}{(\Delta I)(f_0)(V_{IN})}$$

where  $f_0$  = operating frequency. Given an inductor value (L), the peak inductor current is the sum of the average inductor current ( $I_{AVG}$ ) and half the inductor ripple current ( $\Delta I$ ), or:

$$I_{PK} = I_{AVG} + \frac{(V_{OUT})(V_{IN} - V_{OUT})}{(2)(L)(f_0)(V_{IN})}$$

The inductor core type is determined by peak current and efficiency requirements. The inductor core must withstand peak current without saturating, and series winding resistance and core losses should be kept as small as is practical to maximize conversion efficiency.

The LT1339 peak current limit threshold is 40% greater than the average current limit threshold. Slope compensation effects reduce this margin as duty cycle increases. This margin must be maintained to prevent peak current limit from corrupting the programmed value for average current limit. Programming the peak ripple current to less than 15% of the desired average current limit value will

4

## APPLICATIONS INFORMATION

assure proper operation of the average current limit feature through 90% duty cycle (see Slope Compensation section).

### Oscillator Synchronization

The LT1339 oscillator generates a modified sawtooth waveform at the  $C_T$  pin between low and high thresholds of about 0.8V (vl) and 2.5V (vh) respectively. The oscillator can be synchronized by driving a TTL level pulse into the SYNC pin. This inputs to a one-shot circuit that reduces the oscillator high threshold to 2V for about 200ns. The SYNC input signal should have on/off times of  $\geq 1\mu\text{s}$ .

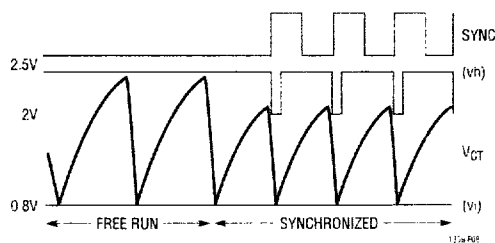

**Figure 8. Free Run and Synchronized Oscillator Waveforms (at  $C_T$  Pin)**

### Slope Compensation

Current mode switching regulators that operate with a duty cycle greater than 50% and have continuous inductor current can exhibit duty cycle instability. While a regulator will not be damaged and may even continue to function acceptably during this type of subharmonic oscillation, an irritating high-pitched squeal is usually produced.

The criterion for current mode duty cycle instability is met when the increasing slope of the inductor ripple current is less than the decreasing slope, which is the case at duty cycles greater than 50%. This condition is illustrated in Figure 9a. The inductor ripple current starts at  $I_1$ , at the beginning of each oscillator switch cycle. Current increases at a rate  $S_1$  until the current reaches the control trip level  $I_2$ . The controller servo loop then disables the main switch (and enables the synchronous switch) and inductor current begins to decrease at a rate  $S_2$ . If the current switch point ( $I_2$ ) is perturbed slightly and increased by  $\Delta I$ , the cycle time ends such that the minimum current point is increased by a factor of  $(1 + S_2/S_1)$

to start the next cycle. On each successive cycle, this error is multiplied by a factor of  $S_2/S_1$ . Therefore, if  $S_2/S_1 \geq 1$ , the system is unstable.

Subharmonic oscillations can be eliminated by augmenting the increasing ripple current slope ( $S_1$ ) in the control loop. This is accomplished by adding an artificial ramp on the inductor current waveform internal to the IC (with a slope  $S_X$ ) as shown in Figure 9b. If the sum of the slopes  $S_1 + S_X$  is greater than  $S_2$ , the condition for subharmonic oscillation no longer exists.

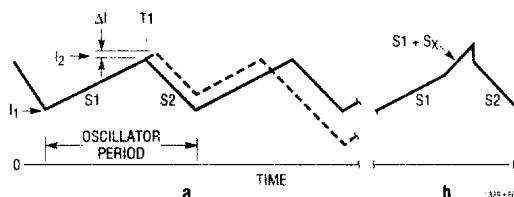

**Figure 9. Inductor Current at DC > 50% and Slope Compensation Adjusted Signal**

For a Buck converter, the required additional current waveform slope, or "Slope Compensation," follows the relation:

$$S_X \geq \left( \frac{V_{IN}}{L} \right) (2DC - 1)$$

For duty cycles less than 50% ( $DC < 0.5$ ),  $S_X$  is negative and is not required. For duty cycles greater than 50%,  $S_X$  takes on values dependent on  $S_1$  and duty cycle. This leads to a minimum inductance requirement for a given  $V_{IN}$  and duty cycle of:

$$L_{MIN} = \left( \frac{V_{IN}}{S_X} \right) (2DC - 1)$$

The LT1339 contains an internal  $S_X$  slope compensation ramp that has an equivalent current referred value of:

$$0.084 \left( \frac{f_0}{R_{SENSE}} \right) \quad \text{Amp/s}$$

where  $f_0$  is oscillator frequency. This yields a minimum inductance requirement of:

## APPLICATIONS INFORMATION

$$L_{MIN} \geq \frac{(V_{IN})(R_{SENSE})(2DC - 1)}{(0.084)(f_0)}$$

A down side of slope compensation is that, since the IC servo loop senses an increase in perceived inductor current, the internal current limit functions are affected such that the maximum current capability of a regulator is reduced by the same amount as the effective current referred slope compensation. The LT1339, however, uses a current limit scheme that is independent of slope compensation effects (Average Current Limit). This provides operation at any duty cycle with no reduction in current sourcing capability, provided ripple current peak amplitude is less than 15% of the current limit value. For example, if the supply is set up to current limit at 10A, as long as the peak inductor current is less than 11.5A, duty cycles up to 90% can be achieved without compromising the average current limit value.

If an inductor smaller than the minimum required for internal slope compensation (calculated above as  $L_{MIN}$ ) is desired, additional slope compensation is required. The LT1339 provides this capability through the SL/ADJ pin. This feature is implemented by referencing this pin via a resistor divider from the 5V<sub>REF</sub> pin to ground. The additional slope compensation will be affected at the point in the oscillator waveform (at pin CT) corresponding to the voltage set by the resistor divider. Additional slope compensation can be calculated using the relation:

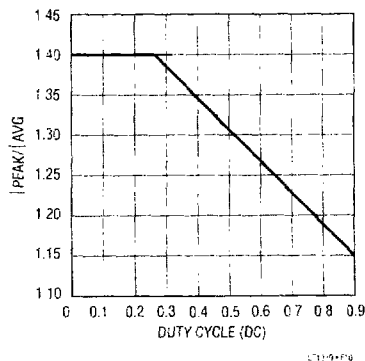

Figure 10. Maximum Ripple Current (Normalized) vs Duty Cycle for Average Current Limit

$$S_{XADD} = \frac{(2500)(f_0)}{(R_{EQ})(R_{SENSE})} \text{ Amp/s}$$

where  $R_{EQ}$  is the effective resistance of the resistor divider. Actual compensation will be somewhat greater due to internal curvature correction circuitry that imposes an exponential increase in the slope compensation waveform, further increasing the effective compensation slope up to 20% for a given setting.

Design Example:

$$\begin{aligned} V_{IN} &= 20V \\ V_{OUT} &= 15V \text{ (DC} = 0.75) \\ R_{SENSE} &= 0.01\Omega \\ f_0 &= 100kHz \\ L &= 5\mu H \end{aligned}$$

The minimum inductor usable with no additional slope compensation is:

$$L_{MIN} \geq \frac{(20V)(0.01\Omega)(1.5 - 1)}{(0.084)(100000)} = 11.9\mu H$$

Since  $L = 20\mu H$  is less than  $L_{MIN}$ , additional slope compensation is necessary. The total slope compensation required is:

$$S_X \geq \left( \frac{20V}{5\mu H} \right) (1.5 - 1) = (2)(10^6) \text{ Amp/s}$$

Subtracting the internally generated slope compensation and solving for the required effective resistance at SL/ADJ yields:

$$R_{EQ} \leq \frac{(2500)(f_0)}{(2)(10^6)(R_{SENSE}) - (0.084)(f_0)} = 21.5k$$

Setting the resistor divider reference voltage at 2V assures that the additional compensation waveform will be enabled at 75% duty cycle. As shown in Figure 11a, using  $R_{SL1} = 45k$  and  $R_{SL2} = 30k$  sets the desired reference voltage and has a  $R_{EQ}$  of 18k, which meets both design requirements. Figure 11b shows the slope compensation effective waveforms both with and without the SL/ADJ external resistors.

**APPLICATIONS INFORMATION**

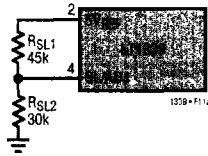

**Figure 11a. External Slope Compensation Resistors**

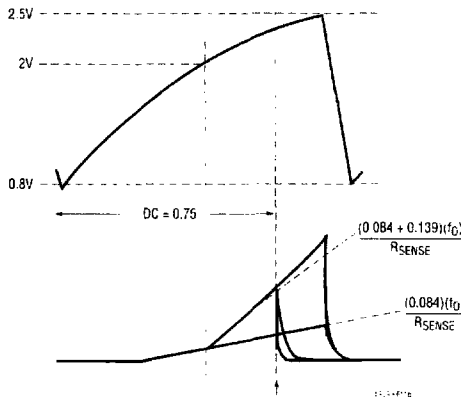

**Figure 11b. Slope Compensation Waveforms**

**Power MOSFET and Catch Diode Selection**

External N-channel MOSFET switches are used with the LT1339. The positive gate-source drive voltage of the LT1339 for both switches is roughly equivalent to the  $12V_{IN}$  supply voltage, so standard threshold MOSFETs can be used.

Selection criteria for the power MOSFETs include the “ON” resistance ( $R_{DS(ON)}$ ), reverse transfer capacitance ( $C_{RSS}$ ), maximum drain-source voltage ( $V_{DSS}$ ) and maximum output current.

The power FETs selected must have a maximum operating  $V_{DSS}$  exceeding the maximum  $V_{IN}$ .  $V_{GS}$  voltage maximum must exceed the  $12V_{IN}$  supply voltage.

Once voltage requirements have been determined,  $R_{DS(ON)}$  can be selected based on allowable power dissipation and required output current.

In an LT1339 Buck converter, the average inductor current is equal to the DC load current. The average currents through the main and synchronous switches are:

$$I_{MAIN} = (I_{LOAD})(DC)$$

$$I_{SYNC} = (I_{LOAD})(1 - DC)$$

The  $R_{DS(ON)}$  required for a given conduction loss can be calculated using the relation:

$$P_{LOSS} = (I_{SWITCH})^2(R_{DS(ON)})$$

In high voltage applications ( $V_{IN} > 20V$ ), the topside switch is required to slew very large voltages. As  $V_{IN}$  increases, transition losses increase through a square relation, until it becomes the dominant power loss term in the main switch. This transition loss takes the form:

$$P_{TR} \approx (k)(V_{IN})^2(I_{MAX})(C_{RSS})(f_0)$$

where k is a constant inversely related to the gate drive current, approximated by  $k = 2$  in LT1339 applications.

The maximum power loss terms for the switches are thus:

$$P_{MAIN} = (DC)(I_{MAX})^2(1 + \delta)(R_{DS(ON)}) + 2(V_{IN})^2(I_{MAX})(C_{RSS})(f_0)$$

$$P_{SYNC} = (1 - DC)(I_{MAX})^2(1 + \delta)(R_{DS(ON)})$$

The  $(1 + \delta)$  term in the above relations is the temperature dependency of  $R_{DS(ON)}$ , typically given in the form of a normalized  $R_{DS(ON)}$  vs Temperature curve in a MOSFET data sheet.

In some applications, parasitic FET capacitances couple the negative going switch node transient onto the bottom gate drive pin of the LT1339, causing a negative voltage in excess of the Absolute Maximum Rating to be imposed on that pin. Connection of a catch Schottky (rated to about 1A is typically sufficient) from this pin to ground will eliminate this effect.

**$C_{IN}$  and  $C_{OUT}$  Supply Decoupling Capacitor Selection**

The large currents typical of LT1339 applications require special consideration for the converter input and output supply decoupling capacitors. Under normal steady state operation, the source current of the main switch MOSFET is a square wave of duty cycle  $V_{OUT}/V_{IN}$ . Most of this current is provided by the input bypass capacitor. To prevent large input voltage transients and avoid bypass capacitor heating, a low ESR input capacitor sized for the maximum RMS current must be used. This maximum capacitor RMS current follows the relation:

## APPLICATIONS INFORMATION

$$I_{RMS} \approx \frac{(I_{MAX})(V_{OUT}(V_{IN} - V_{OUT}))^{1/2}}{V_{IN}}$$

which peaks at a 50% duty cycle, when  $I_{RMS} = I_{MAX}/2$ . Capacitor ripple current ratings are often based on only 2000 hours (three months) lifetime; it is advisable to derate either the ESR or temperature rating of the capacitor for increased MTBF of the regulator.

The output capacitor in a Buck converter generally has much less ripple current than the input capacitor. Peak-to-peak ripple current is equal to that in the inductor ( $\Delta I_L$ ), typically a fraction of the load current.  $C_{OUT}$  is selected to reduce output voltage ripple to a desirable value given an expected output ripple current. Output ripple ( $\Delta V_{OUT}$ ) is approximated by:

$$\Delta V_{OUT} \approx \Delta I_L [ESR + (4)(f_0) \bullet C_{OUT}^{-1}]$$

where  $f_0$  = operating frequency.

### Efficiency Considerations and Heat Dissipation

High output power applications have inherent concerns regarding power dissipation in converter components. Although high efficiencies are achieved using the LT1339, the power dissipated in the converter climbs to relatively high values when the load draws large amounts of power. Even at 90% efficiency, an application that provides 500W to the load has conversion loss of 55W.

$I^2R$  dissipation through the switches, sense resistor and inductor series resistance create substantial losses under high currents. Generally, the dominant  $I^2R$  loss is evident in the FET switches. Loss in each switch is proportional to the conduction time of that switch. For example, in a 48V to 5V converter the synchronous FET conducts load current for almost 90% of the cycle time and thus, requires greater consideration for dissipating  $I^2R$  power.

Gate charge/discharge current create additional current drain on the 12V supply. If powered from a high voltage input through a linear regulator, the losses in that regulator device can become significant. A supply solution bootstrapped from the output would draw current from a lower voltage source and reduce this loss component.

Transition losses are significant in the topside switch FET when high  $V_{IN}$  voltages are used. Transition losses can be estimated as:

$$P_{TLOSS} \approx 2(V_{IN})^2(I_{MAX})(C_{RSS})(f_0)$$

Since the conduction time in the main switch of a 48V to 5V converter is small, the  $I^2R$  loss in the main switch FET is also small. However, since the FET gate must switch up past the 48V input voltage, transition loss can become a significant factor. In such a case, it is often prudent to take the increased  $I^2R$  loss of a smaller FET in order to reduce  $C_{RSS}$  and thus, the associated transition losses.

### Gate Drive Buffers

The LT1339 is designed to drive relatively large capacitive loads. However, in certain applications, efficiency improvements can be realized by adding an external buffer stage to drive the gates of the FET switches. When the switch gates load the driver outputs such that rise/fall times exceed about 100ns, buffers can sometimes result in efficiency gains. Buffers also reduce the effect of back injection into the bottom side driver output due to coupling of switch node transitions through the switch FET  $C_{MILLER}$ .

4

### Paying the Physicists

In high power synchronous buck configurations, certain physical characteristics of the external MOSFET switches can impact conversion efficiency. As the input voltage approaches about 30V, the bottom MOSFETs will begin to exhibit "phantom turn-on." This phenomenon is caused by coupling of the instantaneous voltage step on the bottom side switch drain through  $C_{MILLER}$  to the device gate, yielding internal localized gate-source voltages above the turn-on threshold of the FET. This generates a shoot-through blip that ultimately eats away at efficiency numbers. In Figure 12 a negative prebias circuit is added to the bottom side gate. The addition of this -3V of negative offset to the bottom gate drive provides additional off-state voltage range to prevent phantom turn-on.

This type of prebias circuit is used in the 48V to 5V, 50A converter pictured in the Typical Applications section.

As currents increase beyond the 10A to 15A range, the bottom side FET body diode experiences hard turn-on during switch dead time due to local current loop inductance preventing the timely transfer of charge to the Schottky catch diode. The charge current required to commutate this body diode creates a high  $dV/dt$  Schottky avalanche when the diode charge is finally exhausted (due



APPLICATIONS INFORMATION

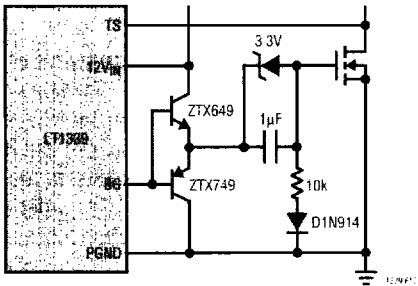

Figure 12. Bottom Side Driver Negative Prebias Circuit

to an effective inductor current discontinuity at the moment the body diode no longer requires charge). This generates an increased turn-on power burst in the topside switch, causing additional conversion efficiency loss. This effect of this parasitic inductance can be reduced by using *FETKEY*™ MOSFETs, which have parallel catch Schottky diodes internal to their packages. *FETKEY* MOSFETs are not available for high voltages, so as input voltage continues to increase, they can no longer be used. Because this necessitates the use of discrete FETs and Schottkys,

interdigitation of a number of smaller devices is required to minimize parasitic inductances. This technique is also used in the 48V to 5V, 50A converter shown in the Typical Applications section.

Optimizing Transient Response—Compensation Component Values

The dominant compensation point for an LT1339 converter is the  $V_C$  pin (Pin 7), or error amplifier output. This pin is connected to a series RC network,  $R_{VC}$  and  $C_{VC}$ . The infinite permutations of input/output filtering, capacitor ESR, input voltage, load current, etc. make for an empirical method of optimizing loop response for a specific set of conditions.

Loop response can be observed by injecting a step change in load current. This can be achieved by using a switchable load. With the load switching, the transient response of the output voltage can be observed with an oscilloscope. Iterating through RC combinations will yield optimized response. Refer to LTC Application Note 19 in *1990 Linear Applications Handbook, Volume 1* for more information.

*FETKEY* is a trademark of International Rectifier Corporation.

TYPICAL APPLICATIONS

5V to 28V DC/DC Synchronous Boost Converter Limits Input Current at 60A (DC)

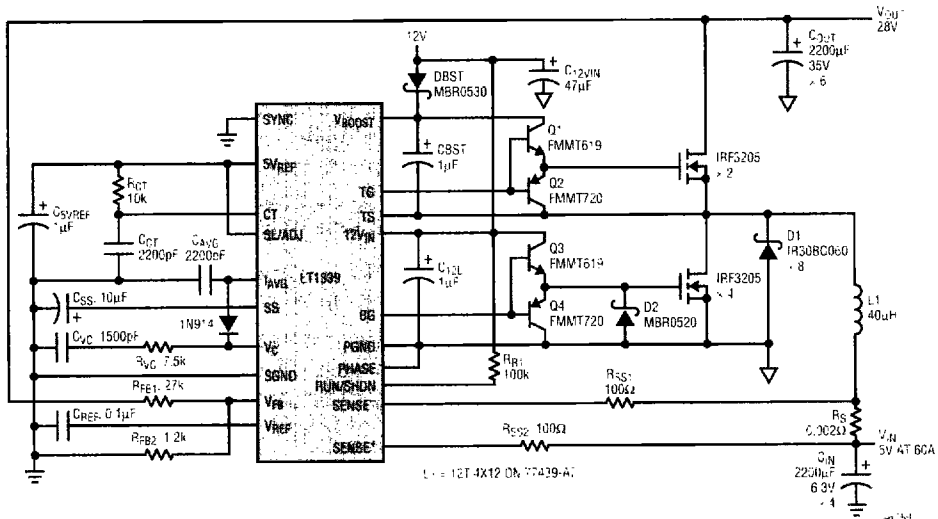

TYPICAL APPLICATIONS

48V to 1.8V 2-Transistor Synchronous Forward Converter

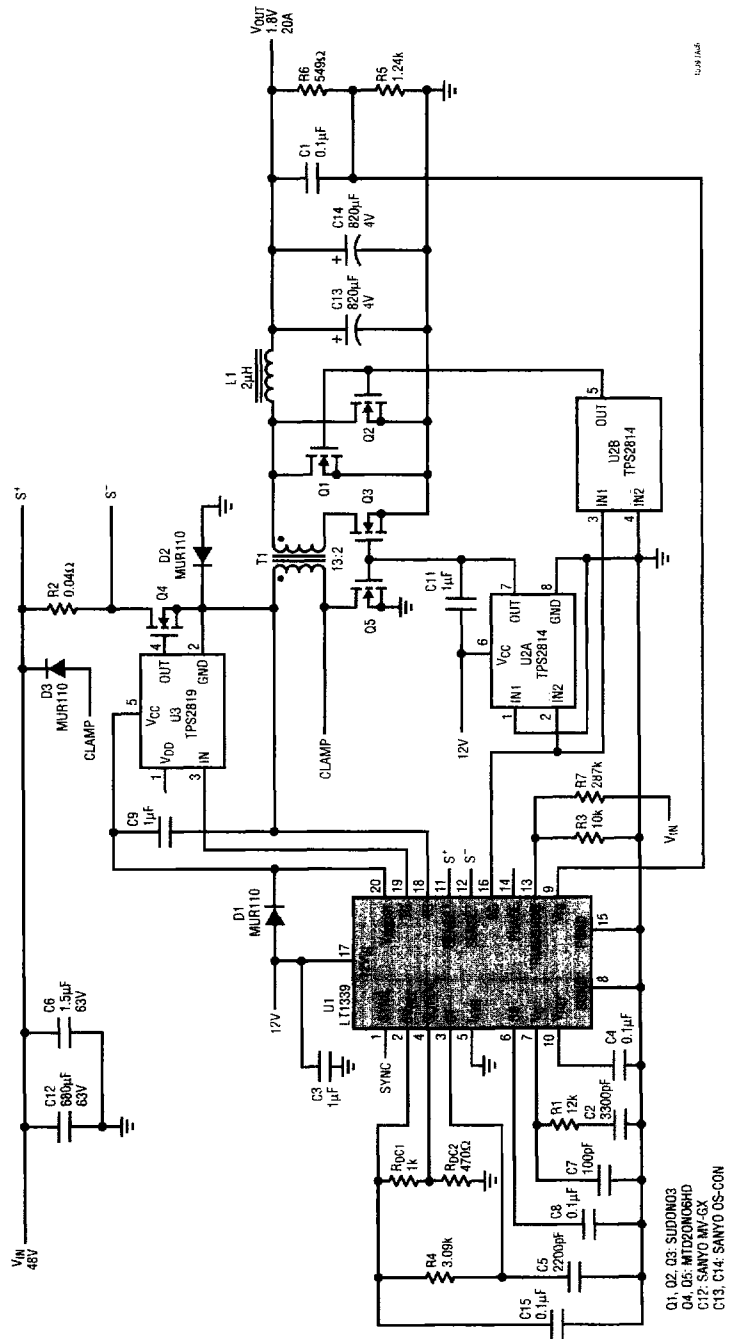

TYPICAL APPLICATIONS

48V to 5V 50A DC/DC Converter with Input Supply Start-Up Protection

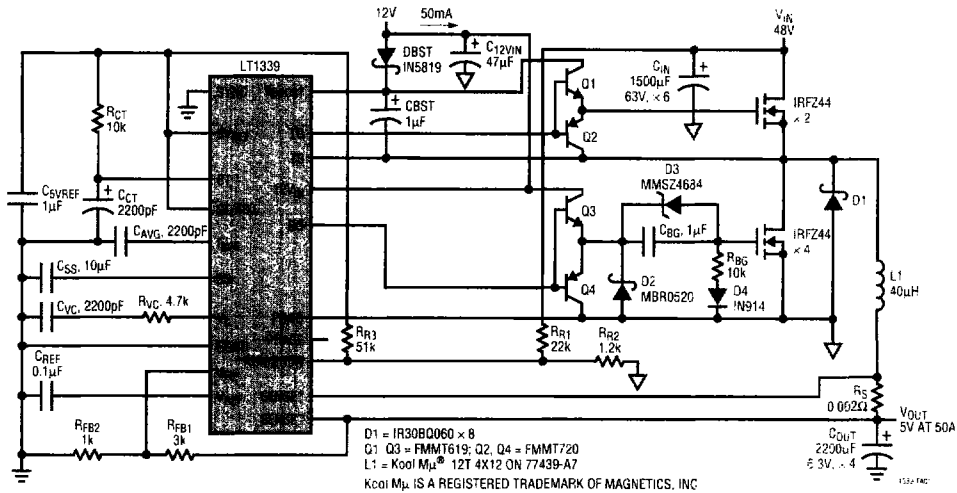

48V to 5V Efficiency Curve

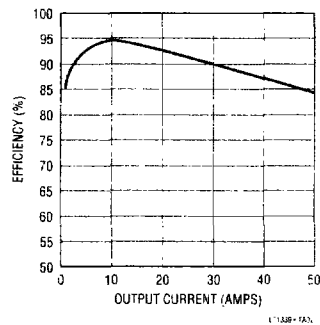

RELATED PARTS

PART NUMBER	DESCRIPTION	COMMENTS
LT1158	Half-Bridge N-Channel MOSFET Driver	Current Limit Protection, 100% of Duty Cycle
LT1160	Half-Bridge N-Channel MOSFET Driver	Up to 60V Input Supply, No Shoot-Through
LT1162	Dual Half-Bridge N-Channel MOSFET Driver	V <sub>IN</sub> to 60V, Good for Full-Bridge Applications
LT1336	Half-Bridge N-Channel MOSFET Driver	Smooth Operation at High Duty Cycle (95% to 100%)
LTC <sup>®</sup> 1430	High Power Step-Down Switching Regulator Controller	Excellent for 5V to 3.xV Up to 50A
LTC1435	High Efficiency, Low Noise Current Mode Step-Down DC/DC Converter	Drives Synchronous N-Channel MOSFETs
LTC1438	Dual High Efficiency, Low Noise Synchronous Step-Down Controller	Tight 1% Reference
LT1680	High Power DC/DC Current Mode Step-Up Controller	High Side Current Sense, Up to 60V Input