

PRELIMINARY

MITSUBISHI MICROCOMPUTERS
M37710E8BXXXFP
M37710E8BFS
PROM VERSION of M37710M8BXXXFP

DESCRIPTION

The M37710E8BXXXFP is a built-in PROM single-chip microcomputer designed with high-performance CMOS silicon gate technology. This is housed in a 80-pin plastic molded QFP. The features of this chip are similar to those of the M37710M8BXXXFP except that this chip has a 32K-byte PROM built in.

This single-chip microcomputer has a large 16M bytes address space, three instruction queue buffers, and two data buffers for high-speed instruction execution. The CPU is a 16-bit parallel processor that can also be switched to perform 8-bit parallel processing. This microcomputer is suitable for office, business, and industrial equipment controller that require high-speed processing of large data.

Since general purpose PROM writer can be used for the built-in PROM, this chip is suitable for small quantity production runs. For program development, the M37710E8BFS with erasable ROM that is housed in a windowed ceramic .CC is also provided.

FEATURES

- Number of basic instructions 103
- Memory size PROM 60K bytes
 RAM 2048 bytes
- Instruction execution time
 The fastest instruction at 25MHz frequency 160ns
- Single power supply 5V±10%
- Low power dissipation (at 25MHz frequency)
 95mW (Typ.)
- Interrupts 19 types 7 levels
- Multiple function 16-bit timer 5+3
 (Pulse motor drive waveform can be output.)
- UART (may also be synchronous) 2
- 10-bit A-D converter 8-channel inputs
- 8-bit D-A converter 2-channel outputs
- 12-bit watchdog timer
- Programmable input/output
 (ports P0, P1, P2, P3, P4, P5, P6, P7, P8) 68

PIN CONFIGURATION (TOP VIEW)

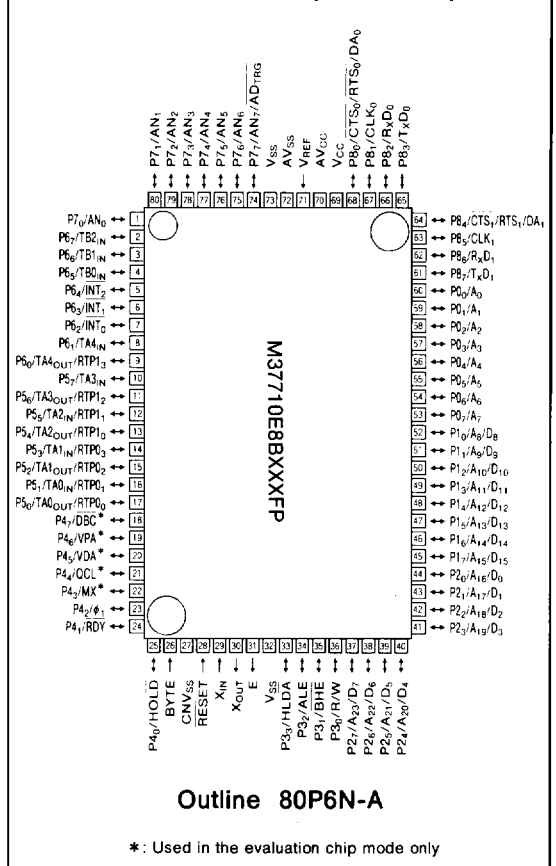

APPLICATION

Control devices for office equipment such as copiers, printers, typewriters, facsimiles, word processors, and personal computers

Control devices for industrial equipment such as communication and measuring instruments

NOTE

- (1) Do not use the M37710E8BFS for mass production because it is a tool for program development (for evaluation).
- (2) Refer to "Chapter 5 PRECAUTIONS" when using this microcomputer.

MITSUBISHI MICROCOMPUTERS
M37710E8BXXXFP
M37710E8BFS

PROM VERSION of M37710M8BXXXFP

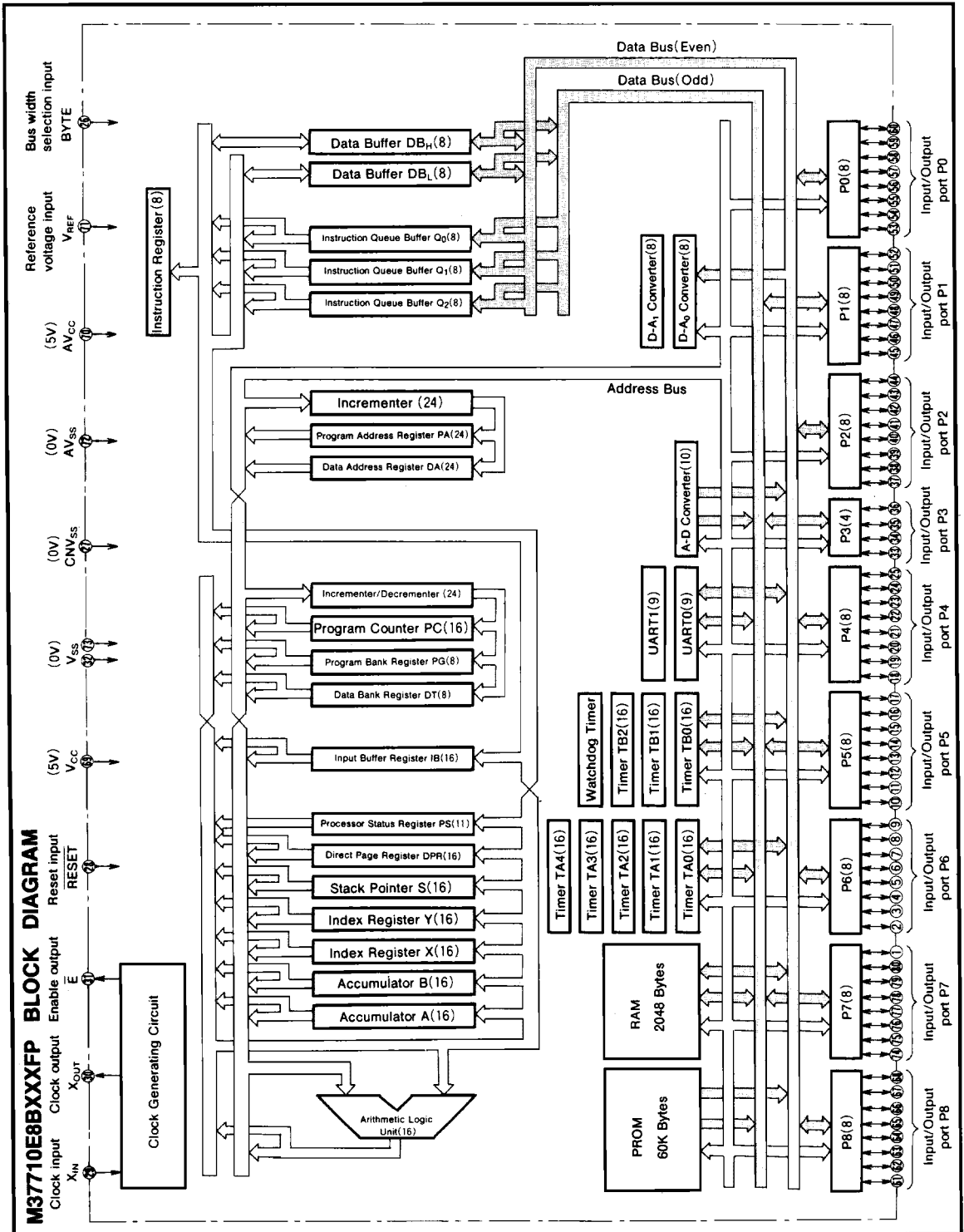

FUNCTIONS OF M37710E8BXXXFP

Parameter		Functions
Number of basic instructions		103
Instruction execution time		160ns (the fastest instruction at external clock 25MHz frequency)
Memory size	PROM	60K bytes
	RAM	2048 bytes
Input/Output ports	P0~P2, P4~P8	8-bitX 8
	P3	4-bitX 1
Multi-function timers	TA0, TA1, TA2, TA3, TA4	16-bitX 5
	TB0, TB1, TB2	16-bitX 3
Serial I/O		(UART or clock synchronous serial I/O)X2
A-D converter		10-bitX 1 (8 channels)
D-A converter		8-bitX 2
Watchdog timer		12-bitX 1
Interrupts		3 external types, 16 internal types (Each interrupt can be set the priority levels to 0~7.)
Clock generating circuit		Built-in (externally connected to a ceramic resonator or quartz crystal resonator)
Supply voltage		5V±10%
Power dissipation		95mW (at external clock 25MHz frequency)
Input/Output characteristic	Input/Output voltage	5V
	Output current	5mA
Memory expansion		Maximum 16M bytes
Operating temperature range		-20~85°C
Device structure		CMOS high-performance silicon gate process
Package	M37710E8BXXXFP	80-pin plastic molded QFP
	M37710E8BFS	80-pin ceramic LCC (with a window)

MITSUBISHI MICROCOMPUTERS
M37710E8BXXXFP
M37710E8BFS

PROM VERSION of M37710M8BXXXFP

PIN DESCRIPTION

Pin	Name	Input/Output	Functions
V _{CC} , V _{SS}	Power supply		Supply 5 V±10% to V _{CC} and 0 V to V _{SS} .
CNV _{SS}	CNV _{SS} input	Input	This pin controls the processor mode. Connect to V _{SS} for single-chip mode, and to V _{CC} for external ROM types.
$\overline{\text{RESET}}$	Reset input	Input	To enter the reset state, this pin must be kept at a "L" condition which should be maintained for the required time.
X _{IN}	Clock input	Input	These are I/O pins of internal clock generating circuit. Connect a ceramic or quartz crystal resonator between X _{IN} and X _{OUT} . When an external clock is used, the clock source should be connected to the X _{IN} pin and the X _{OUT} pin should be left open.
X _{OUT}	Clock output	Output	
$\overline{\text{E}}$	Enable output	Output	Data or instruction read and data write are performed when output from this pin is "L".
BYTE	Bus width selection input	Input	In memory expansion mode or microprocessor mode, this pin determines whether the external data bus is 8-bit width or 16-bit width. The width is 16 bits when "L" signal inputs and 8 bits when "H" signal inputs.
AV _{CC} AV _{SS}	Analog supply input		Power supply for the A-D converter. AV _{SS} is also used for D-A converter. Connect AV _{CC} to V _{CC} and AV _{SS} to V _{SS} externally.
V _{REF}	Reference voltage input	Input	This is reference voltage input pin for the A-D converter and the D-A converter.
P ₀ ~P ₇	I/O port P0	I/O	In single-chip mode, port P0 becomes an 8-bit I/O port. An I/O direction register is available so that each pin can be programmed for input or output. These ports are in input mode when reset. Address(A ₇ ~A ₀) is output in memory expansion mode or microprocessor mode.
P ₁ ~P ₇	I/O port P1	I/O	In single-chip mode, these pins have the same functions as port P0. When the BYTE pin is set to "L" in memory expansion mode or microprocessor mode and external data bus is 16-bit width, high-order data (D ₁₅ ~D ₈) is input or output when $\overline{\text{E}}$ output is "L" and an address (A ₁₅ ~A ₈) is output when $\overline{\text{E}}$ output is "H". If the BYTE pin is "H" that is an external data bus is 8-bit width, only address(A ₁₅ ~A ₈) is output.
P ₂ ~P ₇	I/O port P2	I/O	In single-chip mode, these pins have the same functions as port P0. In memory expansion mode or microprocessor mode low-order data(D ₇ ~D ₀) is input or output when $\overline{\text{E}}$ output is "L" and an address(A ₂₃ ~A ₁₆) is output when $\overline{\text{E}}$ output is "H".
P ₃ ~P ₃	I/O port P3	I/O	In single-chip mode, these pins have the same functions as port P0. In memory expansion mode or microprocessor mode, R/W, BHE, ALE, and HLDA signals are output.
P ₄ ~P ₇	I/O port P4	I/O	In single-chip mode, these pins have the same functions as port P0. In memory expansion mode or microprocessor mode, P ₄ ₀ and P ₄ ₁ become HOLD and RDY input pin respectively. Functions of other pins are the same as in single-chip mode. In single-chip mode or memory expansion mode, port P ₄ ₂ can be programmed for ϕ_1 output pin divided the clock to X _{IN} pin by 2. In microprocessor mode, P ₄ ₂ always has the function as ϕ_1 output pin.
P ₅ ~P ₇	I/O port P5	I/O	In addition to having the same functions as port P0 in single-chip mode, these pins also function as I/O pins for timer A0, timer A1, timer A2 and timer A3. P ₅ ₀ ~P ₅ ₈ also function as output pins for pulse motor drive waveform.
P ₆ ~P ₇	I/O port P6	I/O	In addition to having the same functions as port P0 in single-chip mode, these pins also function as I/O pins for timer A4, external interrupt input INT ₀ , INT ₁ and INT ₂ pins, and input pins for timer B0, timer B1 and timer B2. P ₆ ₀ also functions as an output pin for pulse motor drive waveform.
P ₇ ~P ₇	I/O port P7	I/O	In addition to having the same functions as port P0 in single-chip mode, these pins also function as analog input AN ₀ ~AN ₇ input pins. P ₇ ₇ also has an A-D conversion trigger input function.
P ₈ ~P ₈	I/O port P8	I/O	In addition to having the same functions as port P0 in single-chip mode, these pins also function as R _x D, T _x D, CLK, CTS/RTS pins for UART 0 and UART 1, and output pins for D-A converter.

PIN DESCRIPTION (EPROM MODE)

Pin	Name	Input/Output	Functions
V _{CC} , V _{SS}	Power supply		Supply 5 V±10% to V _{CC} and 0 V to V _{SS} .
CNV _{SS}	V _{PP} input	Input	Connect to V _{PP} when programming or verifying.
BYTE	V _{PP} input	Input	Connect to V _{PP} when programming or verifying.
RESET	Reset input	Input	Connect to V _{SS} .
X _{IN}	Clock input	Input	Connect a ceramic resonator between X _{IN} and X _{OUT} .
X _{OUT}	Clock output	Output	
E	Enable output	Output	Keep open.
AV _{CC} , AV _{SS}	Analog supply input		Connect AV _{CC} to V _{CC} and AV _{SS} to V _{SS} .
V _{REF}	Reference voltage input	Input	Connect to V _{SS} .
P0 ₀ ~P0 ₇	Address input (A ₀ ~A ₇)	Input	Port P0 functions as the lower 8 bits address input (A ₀ ~A ₇).
P1 ₀ ~P1 ₇	Address input (A ₈ ~A ₁₅)	Input	Port P1 functions as the higher 8 bits address input (A ₈ ~A ₁₅).
P2 ₀ ~P2 ₇	Data I/O (D ₀ ~D ₇)	I/O	Port P2 functions as the 8 bits data bus (D ₀ ~D ₇).
P3 ₀ ~P3 ₃	Input port P3	Input	Connect to V _{SS} .
P4 ₀ ~P4 ₇	Input port P4	Input	Connect to V _{SS} .
P5 ₀ ~P5 ₇	Control signal input	Input	P5 ₀ , P5 ₁ and P5 ₂ function as PGM, OE and CE input pins respectively. Connect P5 ₃ , P5 ₄ , P5 ₅ and P5 ₆ to V _{CC} . Connect P5 ₇ to V _{SS} .
P6 ₀ ~P6 ₇	Input port P6	Input	Connect to V _{SS} .
P7 ₀ ~P7 ₇	Input port P7	Input	Connect to V _{SS} .
P8 ₀ ~P8 ₇	Input port P8	Input	Connect to V _{SS} .

BASIC FUNCTION BLOCKS

The M37710E8BXXXFP has the same functions as the M37710M4BXXXFP except for the following:

- (1) The built-in ROM is PROM.
- (2) The ROM size is 60K bytes
- (3) The RAM size is 2048 bytes

Therefore, refer to the section on the M37710M4BXXXFP.

MEMORY

The memory map is shown in Figure 1.

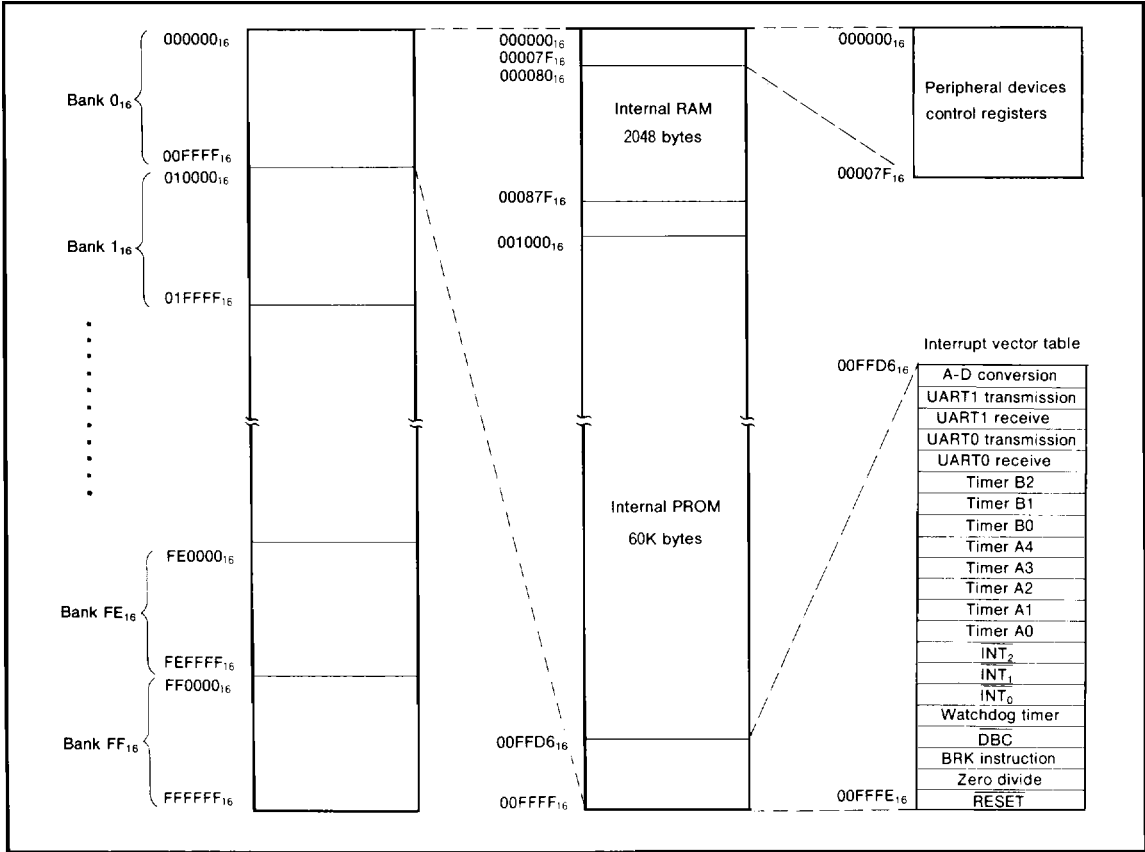

Fig. 1 Memory map

MITSUBISHI MICROCOMPUTERS
M37710E8BXXXFP
M37710E8BFS

PROM VERSION of M37710M8BXXXFP

EPROM MODE

The M37710E8BXXXFP features an EPROM mode in addition to its normal modes. When the RESET signal level is "L", the chip automatically enters the EPROM mode. Table 1 list the correspondence between pins and Figure 2 shows the pin connections in the EPROM mode.

The EPROM mode is the 1M mode for the EPROM that is equivalent to the M5M27C101K.

When in the EPROM mode, ports P0, P1, P2, P5₀, P5₁, P5₂, CNV_{SS} and BYTE are used for the EPROM (equivalent to

the M5M27C101K). When in this mode, the built-in PROM can be written to or read from using these pins in the same way as with the M5M27C101K.

This chip does not have Device Identifier Mode, so that set the corresponding program algorithm. The program area should specify address 11000₁₆~1FFFF₁₆.

Connect the clock which is either ceramic resonator or external clock to X_{IN} pin and X_{OUT} pin.

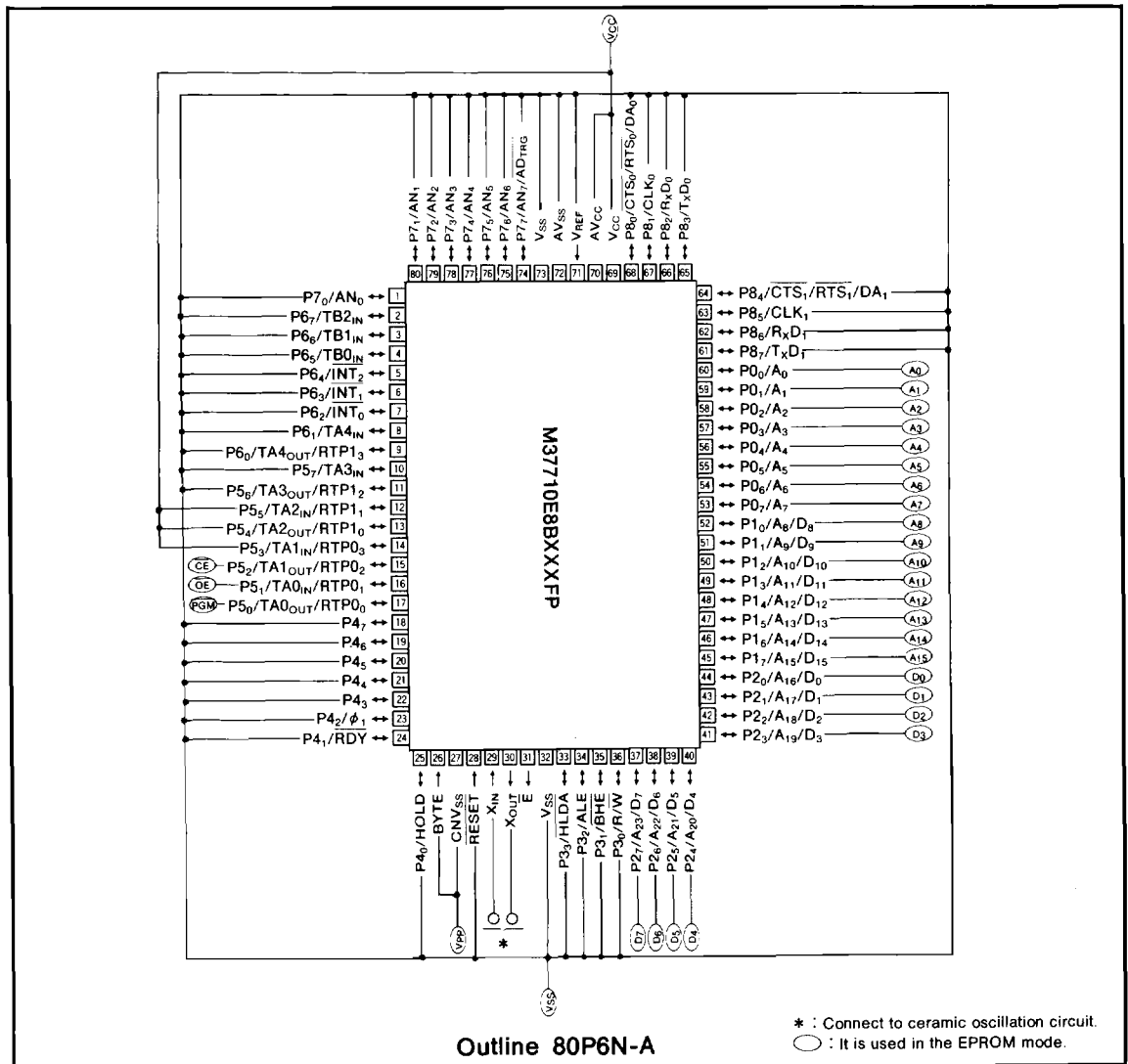

Fig. 2 Pin connection in EPROM mode

Table 1 Pin function in EPROM mode

	M37710E8BXXXFP	M5M27C101K
V _{CC}	V _{CC}	V _{CC}
V _{PP}	CNV _{SS} , BYTE	V _{PP}
V _{SS}	V _{SS}	V _{SS}
Address input	Ports P0, P1	A ₀ ~A ₁₅
Data I/O	Port P2	D ₀ ~D ₇
$\overline{\text{CE}}$	P5 ₂	$\overline{\text{CE}}$
$\overline{\text{OE}}$	P5 ₁	$\overline{\text{OE}}$
PGM	P5 ₀	PGM

M37710E8BXXXFP
M37710E8BFS

PROM VERSION of M37710M8BXXXFP

FUNCTION IN EPROM MODE
1M mode (equivalent to the M5M27C101K)

Reading

To read the EPROM, set the \overline{CE} and \overline{OE} pins to a "L" level. Input the address of the data ($A_0 \sim A_{15}$) to be read, and the data will be output to the I/O pins $D_0 \sim D_7$. The data I/O pins will be floating when either the \overline{CE} or \overline{OE} pins are in the "H" state.

Writing

Writing must be performed in 8 bits by a byte program. To write to the EPROM, set the \overline{CE} pin to a "L" level and the \overline{OE} pin to a "H" level. The CPU will enter the program mode when 12.5V is applied to the V_{PP} pin. The address to be written to is selected with pins $A_0 \sim A_{15}$, and the data to be written is input to pins $D_0 \sim D_7$. Set the \overline{PGM} pin to a "L" level to being writing.

Erasing

To erase data on this chip, use an ultraviolet light source with a 2537 Angstrom wave length. The minimum radiation power necessary for erasing is $15 \text{ W} \cdot \text{s}/\text{cm}^2$.

Writing operation

To program the M37710E8BXXXFP, first set $V_{CC}=6\text{V}$, $V_{PP}=12.5\text{V}$, and set the address to 11000_{16} . Apply a 0.2ms write pulse, check that the data can be read, and if it cannot be read OK, repeat the procedure, applying a 0.2ms write pulse and checking that the data can be read until it can be read OK. Record the accumulated number of pulse applied (X) before the data can be read OK, and then write the data again, applying a further once this number of pulses ($0.2 \times X \text{ ms}$).

When this series of write operations is complete, increment the address, and continue to repeat the procedure above until the last address has been reached.

Finally, when all addresses have been written, read with $V_{CC}=V_{PP}=5\text{V}$ (or $V_{CC}=V_{PP}=5.5\text{V}$).

Table 2. I/O signal in each mode

Mode	Pin			V_{PP}	V_{CC}	Data I/O
	\overline{CE}	\overline{OE}	\overline{PGM}			
Read-out	V_{IL}	V_{IL}	X	5 V	5 V	Output
Output	V_{IL}	V_{IH}	X	5 V	5 V	Floating
Disable	V_{IH}	X	X	5 V	5 V	Floating
Programming	V_{IL}	V_{IH}	V_{IL}	12.5V	6 V	Input
Programming Verify	V_{IL}	V_{IL}	V_{IH}	12.5V	6 V	Output
Program Disable	V_{IH}	V_{IH}	V_{IH}	12.5V	6 V	Floating

Note 1 : An X indicates either V_{IL} or V_{IH} .

Program operation (equivalent to the M5M27C101K)

AC ELECTRICAL CHARACTERISTICS ($T_a=25 \pm 5^\circ\text{C}$, $V_{CC}=6\text{V} \pm 0.25\text{V}$, $V_{PP}=12.5 \pm 0.3\text{V}$, unless otherwise noted)

Symbol	Parameter	Test conditions	Limits			Unit
			Min.	Typ.	Max.	
t_{AS}	Address setup time		2			μs
t_{OES}	\overline{OE} setup time		2			μs
t_{DS}	Data setup time		2			μs
t_{AH}	Address hold time		0			μs
t_{DH}	Data hold time		2			μs
t_{DFP}	Output enable to output float delay		0		130	ns
t_{VCS}	V_{CC} setup time		2			μs
t_{VPS}	V_{PP} setup time		2			μs
t_{PW}	\overline{PGM} pulse width		0.19	0.2	0.21	ms
t_{OPW}	\overline{PGM} over program pulse width		0.19		5.25	ms
t_{CES}	\overline{CE} setup time		2			μs
t_{OE}	Data valid from \overline{OE}				150	ns

AC waveforms

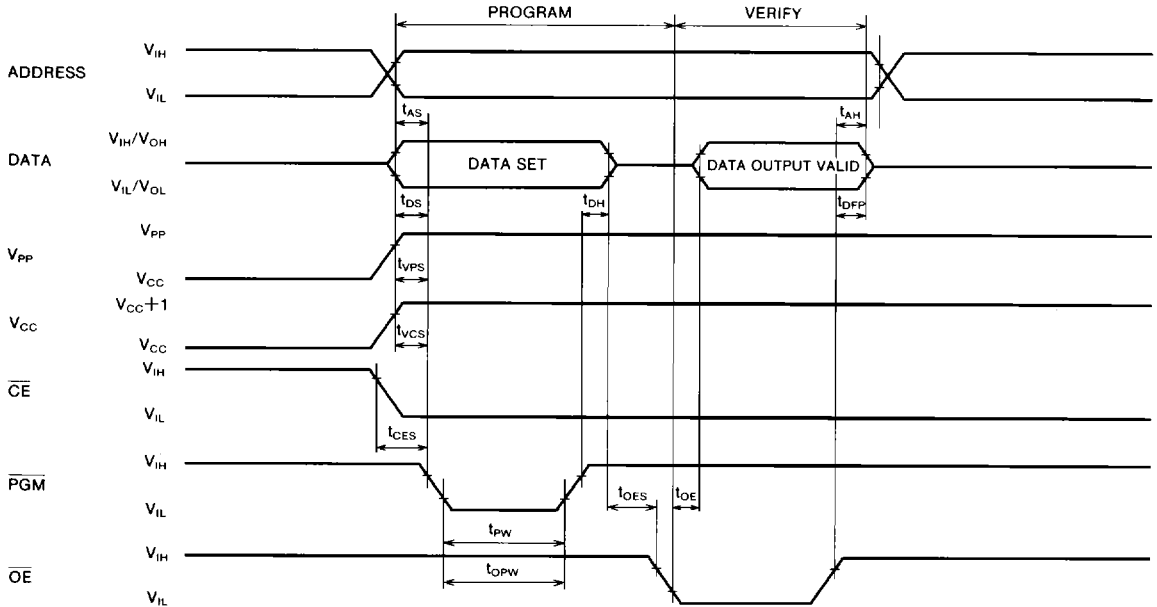

Test conditions for A.C. characteristics
 Input voltage : V_{IL}=0.45V, V_{IH}=2.4V
 Input rise and fall times (10%~90%) : ≤20ns
 Reference voltage at timing measurement : Input, Output
 "L"=0.8V, "H"=2V

Programming algorithm flow chart

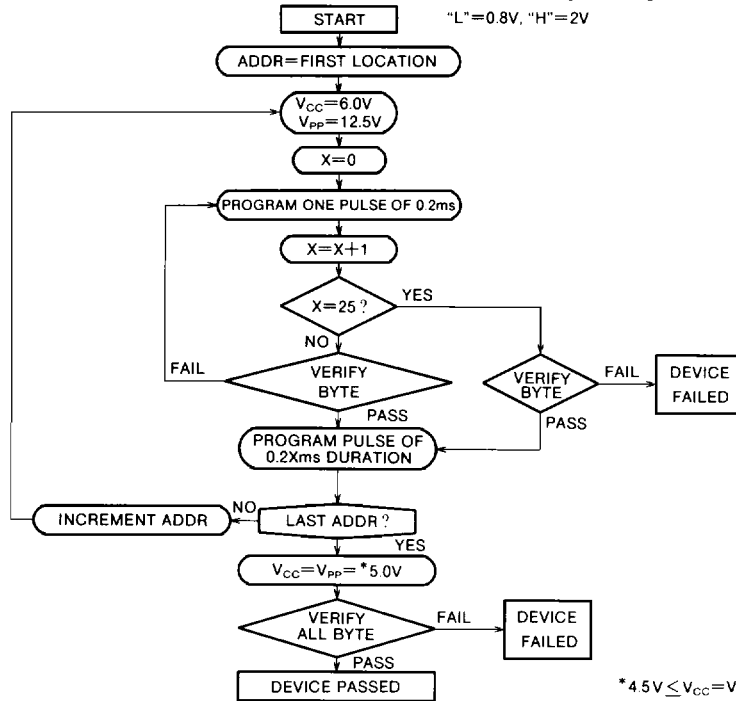

* 4.5V ≤ V_{CC}=V_{PP} ≤ 5.5V

SAFETY INSTRUCTIONS

- (1) Sunlight and fluorescent lamp contain light that can erase written information. When using in read mode, be sure to cover the transparent glass portion with a seal or other materials (ceramic package product).
- (2) Mitsubishi Electric corp. provides the seal for covering the transparent glass. Take care that the seal does not touch the read pins (ceramic package product).
- (3) Clean the transparent glass before erasing. Fingers' fat and paste disturb the passage of ultraviolet rays and may affect badly the erasure capability (ceramic package product).
- (4) A high voltage is used for writing. Take care that over-voltage is not applied. Take care especially at power on.
- (5) The programmable M37710E8BFP that is shipped in blank is also provided. For the M37710E8BFP, Mitsubishi Electric corp. does not perform PROM write test and screening following the assembly processes. To improve reliability after write, performing write and test according to the flow below before use is recommended.

ADDRESSING MODES

The M37710E8BXXXFP has 28 powerful addressing modes. Refer to the MELPS 7700 addressing mode description for the details of each addressing mode.

MACHINE INSTRUCTION LIST

The M37710E8BXXXFP has 103 machine instructions. Refer to the MELPS 7700 machine instruction list for details.

DATA REQUIRED FOR PROM ORDERING

Please send the following data for writing to PROM.

- (1) M37710E8BXXXFP writing to PROM order confirmation form
- (2) 80P6N mark specification form
- (3) ROM data (EPROM 3 sets)

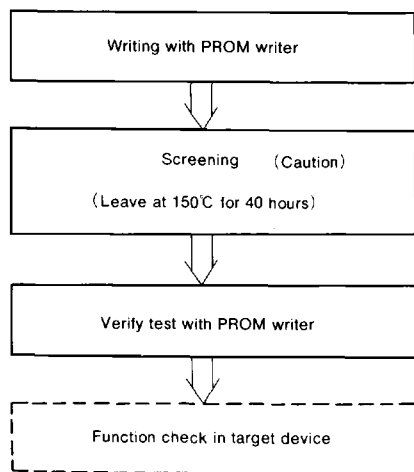

Caution : Never expose to 150 °C exceeding 100 hours.

ABSOLUTE MAXIMUM RATINGS

Symbol	Parameter	Conditions	Ratings	Unit
V _{CC}	Supply voltage		-0.3~7	V
AV _{CC}	Analog supply voltage		-0.3~7	V
V _I	Input voltage RESET, CNV _{SS} , BYTE		-0.3~12(Note 1)	V
V _I	Input voltage P ₀ ~P ₀ ₇ , P ₁ ₀ ~P ₁ ₇ , P ₂ ₀ ~P ₂ ₇ , P ₃ ₀ ~P ₃ ₃ , P ₄ ₀ ~P ₄ ₇ , P ₅ ₀ ~P ₅ ₇ , P ₆ ₀ ~P ₆ ₇ , P ₇ ₀ ~P ₇ ₇ , P ₈ ₀ ~P ₈ ₇ , V _{REF} , X _{IN}		-0.3~V _{CC} +0.3	V
V _O	Output voltage P ₀ ₀ ~P ₀ ₇ , P ₁ ₀ ~P ₁ ₇ , P ₂ ₀ ~P ₂ ₇ , P ₃ ₀ ~P ₃ ₃ , P ₄ ₀ ~P ₄ ₇ , P ₅ ₀ ~P ₅ ₇ , P ₆ ₀ ~P ₆ ₇ , P ₇ ₀ ~P ₇ ₇ , P ₈ ₀ ~P ₈ ₇ , X _{OUT} , E		-0.3~V _{CC} +0.3	V
P _d	Power dissipation	T _a =25°C	300	mW
T _{opr}	Operating temperature		-20~85	°C
T _{stg}	Storage temperature		-40~150	°C

Note 1. Input voltage for CNV_{SS} and BYTE pins is 13V in writing to PROM.

RECOMMENDED OPERATING CONDITIONS (V_{CC}=5V±10%, T_a=-20~85°C, unless otherwise noted)

Symbol	Parameter	Limits			Unit
		Min.	Typ.	Max.	
V _{CC}	Supply voltage	4.5	5.0	5.5	V
AV _{CC}	Analog supply voltage		V _{CC}		V
V _{SS}	Supply voltage		0		V
AV _{SS}	Analog supply voltage		0		V
V _{IH}	High-level input voltage P ₀ ₀ ~P ₀ ₇ , P ₃ ₀ ~P ₃ ₃ , P ₄ ₀ ~P ₄ ₇ , P ₅ ₀ ~P ₅ ₇ , P ₆ ₀ ~P ₆ ₇ , P ₇ ₀ ~P ₇ ₇ , P ₈ ₀ ~P ₈ ₇ , X _{IN} , RESET, CNV _{SS} , BYTE	0.8V _{CC}		V _{CC}	V
V _{IH}	High-level input voltage P ₁ ₀ ~P ₁ ₇ , P ₂ ₀ ~P ₂ ₇ (in single-chip mode)	0.8V _{CC}		V _{CC}	V
V _{IH}	High-level input voltage P ₁ ₀ ~P ₁ ₇ , P ₂ ₀ ~P ₂ ₇ (in memory expansion mode and microprocessor mode)	0.5V _{CC}		V _{CC}	V
V _{IL}	Low-level input voltage P ₀ ₀ ~P ₀ ₇ , P ₃ ₀ ~P ₃ ₃ , P ₄ ₀ ~P ₄ ₇ , P ₅ ₀ ~P ₅ ₇ , P ₆ ₀ ~P ₆ ₇ , P ₇ ₀ ~P ₇ ₇ , P ₈ ₀ ~P ₈ ₇ , X _{IN} , RESET, CNV _{SS} , BYTE	0		0.2V _{CC}	V
V _{IL}	Low-level input voltage P ₁ ₀ ~P ₁ ₇ , P ₂ ₀ ~P ₂ ₇ (in single-chip mode)	0		0.2V _{CC}	V
V _{IL}	Low-level input voltage P ₁ ₀ ~P ₁ ₇ , P ₂ ₀ ~P ₂ ₇ (in memory expansion mode and microprocessor mode)	0		0.16V _{CC}	V
I _{OH(peak)}	High-level peak output current P ₀ ₀ ~P ₀ ₇ , P ₁ ₀ ~P ₁ ₇ , P ₂ ₀ ~P ₂ ₇ , P ₃ ₀ ~P ₃ ₃ , P ₄ ₀ ~P ₄ ₇ , P ₅ ₀ ~P ₅ ₇ , P ₆ ₀ ~P ₆ ₇ , P ₇ ₀ ~P ₇ ₇ , P ₈ ₀ ~P ₈ ₇			-10	mA
I _{OH(avg)}	High-level average output current P ₀ ₀ ~P ₀ ₇ , P ₁ ₀ ~P ₁ ₇ , P ₂ ₀ ~P ₂ ₇ , P ₃ ₀ ~P ₃ ₃ , P ₄ ₀ ~P ₄ ₇ , P ₅ ₀ ~P ₅ ₇ , P ₆ ₀ ~P ₆ ₇ , P ₇ ₀ ~P ₇ ₇ , P ₈ ₀ ~P ₈ ₇			-5	mA
I _{OL(peak)}	Low-level peak output current P ₀ ₀ ~P ₀ ₇ , P ₁ ₀ ~P ₁ ₇ , P ₂ ₀ ~P ₂ ₇ , P ₃ ₀ ~P ₃ ₃ , P ₄ ₀ ~P ₄ ₇ , P ₅ ₀ ~P ₅ ₇ , P ₆ ₀ ~P ₆ ₇ , P ₇ ₀ ~P ₇ ₇ , P ₈ ₀ ~P ₈ ₇			10	mA
I _{OL(avg)}	Low-level average output current P ₀ ₀ ~P ₀ ₇ , P ₁ ₀ ~P ₁ ₇ , P ₂ ₀ ~P ₂ ₇ , P ₃ ₀ ~P ₃ ₃ , P ₄ ₀ ~P ₄ ₇ , P ₅ ₀ ~P ₅ ₇ , P ₆ ₀ ~P ₆ ₇ , P ₇ ₀ ~P ₇ ₇ , P ₈ ₀ ~P ₈ ₇			5	mA
f(X _{IN})	External clock frequency input			25	MHz

Note 2. Average output current is the average value of a 100ms interval.

- The sum of I_{OL(peak)} for ports P₀, P₁, P₂, P₃, and P₈ must be 80mA or less, the sum of I_{OH(peak)} for ports P₀, P₁, P₂, P₃, and P₈ must be 80mA or less, the sum of I_{OL(peak)} for ports P₄, P₅, P₆, and P₇ must be 80mA or less, and the sum of I_{OH(peak)} for ports P₄, P₅, P₆, and P₇ must be 80mA or less.

MITSUBISHI MICROCOMPUTERS
M37710E8BXXFP
M37710E8BFS

PROM VERSION of M37710M8BXXFP

ELECTRICAL CHARACTERISTICS ($V_{CC}=5V$, $V_{SS}=0V$, $T_a=25^\circ C$, $f(X_{IN})=25MHz$, unless otherwise noted)

Symbol	Parameter	Test conditions	Limits			Unit
			Min.	Typ.	Max.	
V_{OH}	High-level output voltage $P0_0\sim P0_7$, $P1_0\sim P1_7$, $P2_0\sim P2_7$, $P3_0$, $P3_1$, $P3_3$, $P4_0\sim P4_7$, $P5_0\sim P5_7$, $P6_0\sim P6_7$, $P7_0\sim P7_7$, $P8_0\sim P8_7$	$I_{OH}=-10mA$	3			V
V_{OH}	High-level output voltage $P0_0\sim P0_7$, $P1_0\sim P1_7$, $P2_0\sim P2_7$, $P3_0$, $P3_1$, $P3_3$	$I_{OH}=-400\mu A$	4.7			V
V_{OH}	High-level output voltage $P3_2$	$I_{OH}=-10mA$ $I_{OH}=-400\mu A$	3.1 4.8			V
V_{OH}	High-level output voltage \bar{E}	$I_{OH}=-10mA$ $I_{OH}=-400\mu A$	3.4 4.8			V
V_{OL}	Low-level output voltage $P0_0\sim P0_7$, $P1_0\sim P1_7$, $P2_0\sim P2_7$, $P3_0$, $P3_1$, $P3_3$, $P4_0\sim P4_7$, $P5_0\sim P5_7$, $P6_0\sim P6_7$, $P7_0\sim P7_7$, $P8_0\sim P8_7$	$I_{OL}=10mA$			2	V
V_{OL}	Low-level output voltage $P0_0\sim P0_7$, $P1_0\sim P1_7$, $P2_0\sim P2_7$, $P3_0$, $P3_1$, $P3_3$	$I_{OL}=2mA$			0.45	V
V_{OL}	Low-level output voltage $P3_2$	$I_{OL}=10mA$ $I_{OL}=2mA$			1.9 0.43	V
V_{OL}	Low-level output voltage \bar{E}	$I_{OL}=10mA$ $I_{OL}=2mA$			1.6 0.4	V
$V_{T+}-V_{T-}$	Hysteresis \overline{HOLD} , \overline{RDY} , $\overline{TA0_{IN}}\sim\overline{TA4_{IN}}$, $\overline{TB0_{IN}}\sim\overline{TB2_{IN}}$, $\overline{INT_0}\sim\overline{INT_2}$, \overline{ADTRG} , $\overline{CTS_0}$, $\overline{CTS_1}$, $\overline{CLK_0}$, $\overline{CLK_1}$		0.4		1	V
$V_{T+}-V_{T-}$	Hysteresis \overline{RESET}		0.2		0.5	V
$V_{T+}-V_{T-}$	Hysteresis X_{IN}		0.1		0.3	V
I_{IH}	High-level input current $P0_0\sim P0_7$, $P1_0\sim P1_7$, $P2_0\sim P2_7$, $P3_0\sim P3_3$, $P4_0\sim P4_7$, $P5_0\sim P5_7$, $P6_0\sim P6_7$, $P7_0\sim P7_7$, $P8_0\sim P8_7$, X_{IN} , \overline{RESET} , $\overline{CNV_{SS}}$, \overline{BYTE}	$V_I=5V$			5	μA
I_{IL}	Low-level input current $P0_0\sim P0_7$, $P1_0\sim P1_7$, $P2_0\sim P2_7$, $P3_0\sim P3_3$, $P4_0\sim P4_7$, $P5_0\sim P5_7$, $P6_0\sim P6_7$, $P7_0\sim P7_7$, $P8_0\sim P8_7$, X_{IN} , \overline{RESET} , $\overline{CNV_{SS}}$, \overline{BYTE}	$V_I=0V$			-5	μA
V_{RAM}	RAM hold voltage	When clock is stopped.	2			V
I_{CC}	Power supply current	In single-chip mode output only pin is open and other pins are V_{SS} during reset.	$f(X_{IN})=25MHz$, square waveform $T_a=25^\circ C$ when clock is stopped. $T_a=85^\circ C$ when clock is stopped.	19	38 1 20	μA

MITSUBISHI MICROCOMPUTERS
M37710E8BXXXFP
M37710E8BFS

PROM VERSION of M37710M8BXXXFP

A-D CONVERTER CHARACTERISTICS ($V_{CC}=AV_{CC}=5V$, $V_{SS}=AV_{SS}=0V$, $T_a=25^\circ C$, $f(X_{IN})=25MHz$, unless otherwise noted)

Symbol	Parameter	Test conditions	Limits			Unit
			Min.	Typ.	Max.	
—	Resolution	$V_{REF}=V_{CC}$			10	Bits
—	Absolute accuracy	$V_{REF}=V_{CC}$			± 3	LSB
R_{LADDER}	Ladder resistance	$V_{REF}=V_{CC}$	5		20	$k\Omega$
t_{CONV}	Conversion time		9.44			μs
V_{REF}	Reference voltage		2		V_{CC}	V
V_{IA}	Analog input voltage		0		V_{REF}	V

D-A CONVERTER CHARACTERISTICS ($V_{CC}=5V$, $V_{SS}=AV_{SS}=0V$, $T_a=25^\circ C$, $f(X_{IN})=25MHz$, unless otherwise noted)

Symbol	Parameter	Test conditions	Limits			Unit
			Min.	Typ.	Max.	
—	Resolution				8	Bits
—	Absolute accuracy				1.0	%
t_{SU}	Set time				3	μs
R_O	Output resistance		1	2.5	4	$k\Omega$
I_{VREF}	Reference power input current	(Note 1)			3.2	mA

Note 1. One D-A converter is used, and the value of D-A register for unused D-A converter is "00₁₆"
 Current that flows to the ladder resistance of A-D converter is excluded.

TIMING REQUIREMENTS ($V_{CC}=5V\pm 10\%$, $V_{SS}=0V$, $T_a=25^\circ C$, $f(X_{IN})=25MHz$, unless otherwise noted)

External clock input

Symbol	Parameter	Limits		Unit
		Min.	Max.	
t_C	External clock input cycle time	40		ns
$t_{W(H)}$	External clock input high-level pulse width	15		ns
$t_{W(L)}$	External clock input low-level pulse width	15		ns
t_r	External clock rise time		8	ns
t_f	External clock fall time		8	ns

Single-chip mode

Symbol	Parameter	Limits		Unit
		Min.	Max.	
$t_{SU}(P0D-E)$	Port P0 input setup time	60		ns
$t_{SU}(P1D-E)$	Port P1 input setup time	60		ns
$t_{SU}(P2D-E)$	Port P2 input setup time	60		ns
$t_{SU}(P3D-E)$	Port P3 input setup time	60		ns
$t_{SU}(P4D-E)$	Port P4 input setup time	60		ns
$t_{SU}(P5D-E)$	Port P5 input setup time	60		ns
$t_{SU}(P6D-E)$	Port P6 input setup time	60		ns
$t_{SU}(P7D-E)$	Port P7 input setup time	60		ns
$t_{SU}(P8D-E)$	Port P8 input setup time	60		ns
$t_{H}(E-P0D)$	Port P0 input hold time	0		ns
$t_{H}(E-P1D)$	Port P1 input hold time	0		ns
$t_{H}(E-P2D)$	Port P2 input hold time	0		ns
$t_{H}(E-P3D)$	Port P3 input hold time	0		ns
$t_{H}(E-P4D)$	Port P4 input hold time	0		ns
$t_{H}(E-P5D)$	Port P5 input hold time	0		ns
$t_{H}(E-P6D)$	Port P6 input hold time	0		ns
$t_{H}(E-P7D)$	Port P7 input hold time	0		ns
$t_{H}(E-P8D)$	Port P8 input hold time	0		ns

Memory expansion mode and microprocessor mode

Symbol	Parameter	Limits		Unit
		Min.	Max.	
$t_{SU}(P1D-E)$	Port P1 input setup time	30		ns
$t_{SU}(P2D-E)$	Port P2 input setup time	30		ns
$t_{SU}(RDY-\phi_1)$	RDY input setup time	55		ns
$t_{SU}(HOLD-\phi_1)$	HOLD input setup time	55		ns
$t_{H}(E-P1D)$	Port P1 input hold time	0		ns
$t_{H}(E-P2D)$	Port P2 input hold time	0		ns
$t_{H}(\phi_1-RDY)$	RDY input hold time	0		ns
$t_{H}(\phi_1-HOLD)$	HOLD input hold time	0		ns

MITSUBISHI MICROCOMPUTERS
M37710E8BXXFP
M37710E8BFS

PROM VERSION of M37710M8BXXFP

Timer A input (Count input in event counter mode)

Symbol	Parameter	Limits		Unit
		Min.	Max.	
$t_{C(TA)}$	TA _{IN} input cycle time	80		ns
$t_{W(TAH)}$	TA _{IN} input high-level pulse width	40		ns
$t_{W(TAL)}$	TA _{IN} input low-level pulse width	40		ns

Timer A input (Gating input in timer mode)

Symbol	Parameter	Limits		Unit
		Min.	Max.	
$t_{C(TA)}$	TA _{IN} input cycle time	320		ns
$t_{W(TAH)}$	TA _{IN} input high-level pulse width	160		ns
$t_{W(TAL)}$	TA _{IN} input low-level pulse width	160		ns

Timer A input (External trigger input in one-shot pulse mode)

Symbol	Parameter	Limits		Unit
		Min.	Max.	
$t_{C(TA)}$	TA _{IN} input cycle time	160		ns
$t_{W(TAH)}$	TA _{IN} input high-level pulse width	80		ns
$t_{W(TAL)}$	TA _{IN} input low-level pulse width	80		ns

Timer A input (External trigger input in pulse width modulation mode)

Symbol	Parameter	Limits		Unit
		Min.	Max.	
$t_{W(TAH)}$	TA _{IN} input high-level pulse width	80		ns
$t_{W(TAL)}$	TA _{IN} input low-level pulse width	80		ns

Timer A input (Up-down input in event counter mode)

Symbol	Parameter	Limits		Unit
		Min.	Max.	
$t_{C(UP)}$	TA _{OUT} input cycle time	2000		ns
$t_{W(UPH)}$	TA _{OUT} input high-level pulse width	1000		ns
$t_{W(UPL)}$	TA _{OUT} input low-level pulse width	1000		ns
$t_{SU(UP-TIN)}$	TA _{OUT} input setup time	400		ns
$t_{H(TIN-UP)}$	TA _{OUT} input hold time	400		ns

Timer B input (Count input in event counter mode)

Symbol	Parameter	Limits		Unit
		Min.	Max.	
$t_{C(TB)}$	TB _{IN} input cycle time (one edge count)	80		ns
$t_{W(TBH)}$	TB _{IN} input high-level pulse width (one edge count)	40		ns
$t_{W(TBL)}$	TB _{IN} input low-level pulse width (one edge count)	40		ns
$t_{C(TB)}$	TB _{IN} input cycle time (both edges count)	160		ns
$t_{W(TBH)}$	TB _{IN} input high-level pulse width (both edges count)	80		ns
$t_{W(TBL)}$	TB _{IN} input low-level pulse width (both edges count)	80		ns

Timer B input (Pulse period measurement mode)

Symbol	Parameter	Limits		Unit
		Min.	Max.	
$t_{C(TB)}$	TB _{IN} input cycle time	320		ns
$t_{W(TBH)}$	TB _{IN} input high-level pulse width	160		ns
$t_{W(TBL)}$	TB _{IN} input low-level pulse width	160		ns

Timer B input (Pulse width measurement mode)

Symbol	Parameter	Limits		Unit
		Min.	Max.	
$t_{C(TB)}$	TB _{IN} input cycle time	320		ns
$t_{W(TBH)}$	TB _{IN} input high-level pulse width	160		ns
$t_{W(TBL)}$	TB _{IN} input low-level pulse width	160		ns

A-D trigger input

Symbol	Parameter	Limits		Unit
		Min.	Max.	
$t_{C(AD)}$	AD _{TRG} input cycle time (minimum allowable trigger)	1000		ns
$t_{W(ADL)}$	AD _{TRG} input low-level pulse width	125		ns

Serial I/O

Symbol	Parameter	Limits		Unit
		Min.	Max.	
$t_{C(CLK)}$	CLK _j input cycle time	200		ns
$t_{W(CLKH)}$	CLK _j input high-level pulse width	100		ns
$t_{W(CLKL)}$	CLK _j input low-level pulse width	100		ns
$t_{d(C-O)}$	TxD _j output delay time		80	ns
$t_{h(C-O)}$	TxD _j hold time	0		ns
$t_{SU(D-C)}$	RxD _j input setup time	30		ns
$t_{h(C-D)}$	RxD _j input hold time	90		ns

External interrupt INT_j input

Symbol	Parameter	Limits		Unit
		Min.	Max.	
$t_{W(INH)}$	INT _j input high-level pulse width	250		ns
$t_{W(INL)}$	INT _j input low-level pulse width	250		ns

SWITCHING CHARACTERISTICS ($V_{CC}=5V\pm 10\%$, $V_{SS}=0V$, $T_a=25^\circ C$, $f(X_{IN})=25MHz$, unless otherwise noted)

Single-chip mode

Symbol	Parameter	Test conditions	Limits		Unit
			Min.	Max.	
$t_{d(E-P0Q)}$	Port P0 data output delay time	Fig. 3		80	ns
$t_{d(E-P1Q)}$	Port P1 data output delay time			80	ns
$t_{d(E-P2Q)}$	Port P2 data output delay time			80	ns
$t_{d(E-P3Q)}$	Port P3 data output delay time			80	ns
$t_{d(E-P4Q)}$	Port P4 data output delay time			80	ns
$t_{d(E-P5Q)}$	Port P5 data output delay time			80	ns
$t_{d(E-P6Q)}$	Port P6 data output delay time			80	ns
$t_{d(E-P7Q)}$	Port P7 data output delay time			80	ns
$t_{d(E-P8Q)}$	Port P8 data output delay time			80	ns

Memory expansion mode and microprocessor mode (when wait bit = "1")

Symbol	Parameter	Test conditions	Limits		Unit	
			Min.	Max.		
$t_{d(P0A-E)}$	Port P0 address output delay time	Fig. 3	12		ns	
$t_{d(E-P1Q)}$	Port P1 data output delay time (BYTE="L")			45	ns	
$tpxz(E-P1Z)$	Port P1 floating start delay time (BYTE="L")			5	ns	
$t_{d(P1A-E)}$	Port P1 address output delay time			12	ns	
$t_{d(P1A-ALE)}$	Port P1 address output delay time			5	ns	
$t_{d(E-P2Q)}$	Port P2 data output delay time				45	ns
$tpxz(E-P2Z)$	Port P2 floating start delay time				5	ns
$t_{d(P2A-E)}$	Port P2 address output delay time			12	ns	
$t_{d(P2A-ALE)}$	Port P2 address output delay time			5	ns	
$t_{d(\phi_1-HLDA)}$	HLDA output delay time				50	ns
$t_{d(ALE-E)}$	ALE output delay time				4	ns
$t_w(ALE)$	ALE pulse width			22	ns	
$t_{d(BHE-E)}$	BHE output delay time			20	ns	
$t_{d(R/W-E)}$	R/W output delay time			20	ns	
$t_{d(E-\phi_1)}$	ϕ_1 output delay time			0	18	ns
$t_h(E-P0A)$	Port P0 address hold time			25	ns	
$t_h(ALE-P1A)$	Port P1 address hold time (BYTE="L")			9	ns	
$t_h(E-P1Q)$	Port P1 data hold time (BYTE="L")			25	ns	
$tpzx(E-P1Z)$	Port P1 floating release delay time (BYTE="L")			25	ns	
$t_h(E-P1A)$	Port P1 address hold time (BYTE="H")			25	ns	
$t_h(ALE-P2A)$	Port P2 address hold time			9	ns	
$t_h(E-P2Q)$	Port P2 data hold time			25	ns	
$tpzx(E-P2Z)$	Port P2 floating release delay time			25	ns	
$t_h(E-BHE)$	BHE hold time			18	ns	
$t_h(E-R/W)$	R/W hold time		18	ns		
$t_w(EL)$	\bar{E} pulse width		50	ns		

MITSUBISHI MICROCOMPUTERS
M37710E8BXXXFP
M37710E8BFS

PROM VERSION of M37710M8BXXXFP

Memory expansion mode and microprocessor mode

(when wait bit = "0", wait selection bit = "1", and external memory area is accessed)

Symbol	Parameter	Test conditions	Limits		Unit	
			Min.	Max.		
$t_{d(P0A-E)}$	Port P0 address output delay time	Fig. 3	12		ns	
$t_{d(E-P1Q)}$	Port P1 data output delay time (BYTE="L")			45	ns	
$t_{pXZ(E-P1Z)}$	Port P1 floating start delay time (BYTE="L")			5	ns	
$t_{d(P1A-E)}$	Port P1 address output delay time		12		ns	
$t_{d(P1A-ALE)}$	Port P1 address output delay time		5		ns	
$t_{d(E-P2Q)}$	Port P2 data output delay time			45	ns	
$t_{pXZ(E-P2Z)}$	Port P2 floating start delay time			5	ns	
$t_{d(P2A-E)}$	Port P2 address output delay time		12		ns	
$t_{d(P2A-ALE)}$	Port P2 address output delay time		5		ns	
$t_{d(\phi_1-HLDA)}$	HLDA output delay time			50	ns	
$t_{d(ALE-E)}$	ALE output delay time			4	ns	
$t_{w(ALE)}$	ALE pulse width			22	ns	
$t_{d(BHE-E)}$	BHE output delay time			20	ns	
$t_{d(R/W-E)}$	R/W output delay time			20	ns	
$t_{d(E-\phi_1)}$	ϕ_1 output delay time			0	18	ns
$t_{h(E-P0A)}$	Port P0 address hold time			25		ns
$t_{h(ALE-P1A)}$	Port P1 address hold time (BYTE="L")			9		ns
$t_{h(E-P1Q)}$	Port P1 data hold time (BYTE="L")			25		ns
$t_{pXZ(E-P1Z)}$	Port P1 floating release delay time (BYTE="L")			25		ns
$t_{h(E-P1A)}$	Port P1 address hold time (BYTE="H")			25		ns
$t_{h(ALE-P2A)}$	Port P2 address hold time			9		ns
$t_{h(E-P2Q)}$	Port P2 data hold time			25		ns
$t_{pXZ(E-P2Z)}$	Port P2 floating release delay time			25		ns
$t_{h(E-BHE)}$	BHE hold time			18		ns
$t_{h(E-R/W)}$	R/W hold time			18		ns
$t_{w(EL)}$	\bar{E} pulse width			130		ns

Memory expansion mode and microprocessor mode

(when wait bit = "0", wait selection bit = "0", and external memory area is accessed)

Symbol	Parameter	Test conditions	Limits		Unit
			Min.	Max.	
$t_{d(P0A-E)}$	Port P0 address output delay time	Fig. 3	92		ns
$t_{d(E-P1Q)}$	Port P1 data output delay time (BYTE="L")			45	ns
$tp_{XZ(E-P1Z)}$	Port P1 floating start delay time (BYTE="L")			5	ns
$t_{d(P1A-E)}$	Port P1 address output delay time		92		ns
$t_{d(P1A-ALE)}$	Port P1 address output delay time		70		ns
$t_{d(E-P2Q)}$	Port P2 data output delay time			45	ns
$tp_{XZ(E-P2Z)}$	Port P2 floating start delay time			5	ns
$t_{d(P2A-E)}$	Port P2 address output delay time		92		ns
$t_{d(P2A-ALE)}$	Port P2 address output delay time		70		ns
$t_{d(\phi_1-HLDA)}$	HLDA output delay time			50	ns
$t_{d(ALE-E)}$	ALE output delay time		15		ns
$t_{W(ALE)}$	ALE pulse width		62		ns
$t_{d(BHE-E)}$	BHE output delay time		100		ns
$t_{d(R/W-E)}$	R/W output delay time		100		ns
$t_{d(E-\phi_1)}$	ϕ_1 output delay time		0	18	ns
$t_{h(E-P0A)}$	Port P0 address hold time		25		ns
$t_{h(ALE-P1A)}$	Port P1 address hold time (BYTE="L")		20		ns
$t_{h(E-P1Q)}$	Port P1 data hold time (BYTE="L")		25		ns
$tp_{ZX(E-P1Z)}$	Port P1 floating release delay time (BYTE="L")		25		ns
$t_{h(E-P1A)}$	Port P1 address hold time (BYTE="H")		25		ns
$t_{h(ALE-P2A)}$	Port P2 address hold time	20		ns	
$t_{h(E-P2Q)}$	Port P2 data hold time	25		ns	
$tp_{ZX(E-P2Z)}$	Port P2 floating release delay time	25		ns	
$t_{h(E-BHE)}$	BHE hold time	18		ns	
$t_{h(E-R/W)}$	R/W hold time	18		ns	
$t_{W(EL)}$	E pulse width	130		ns	

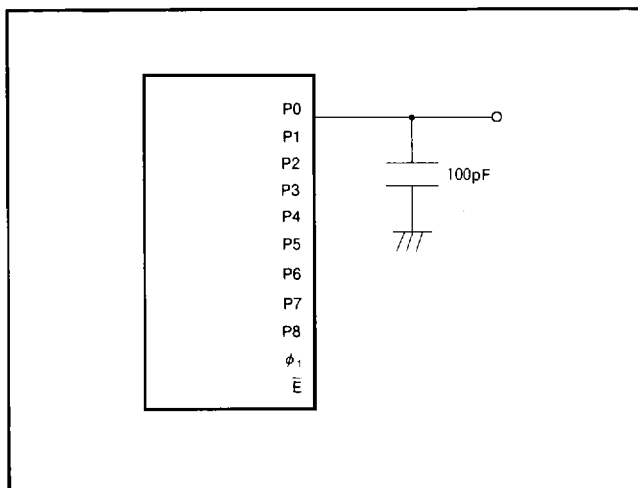
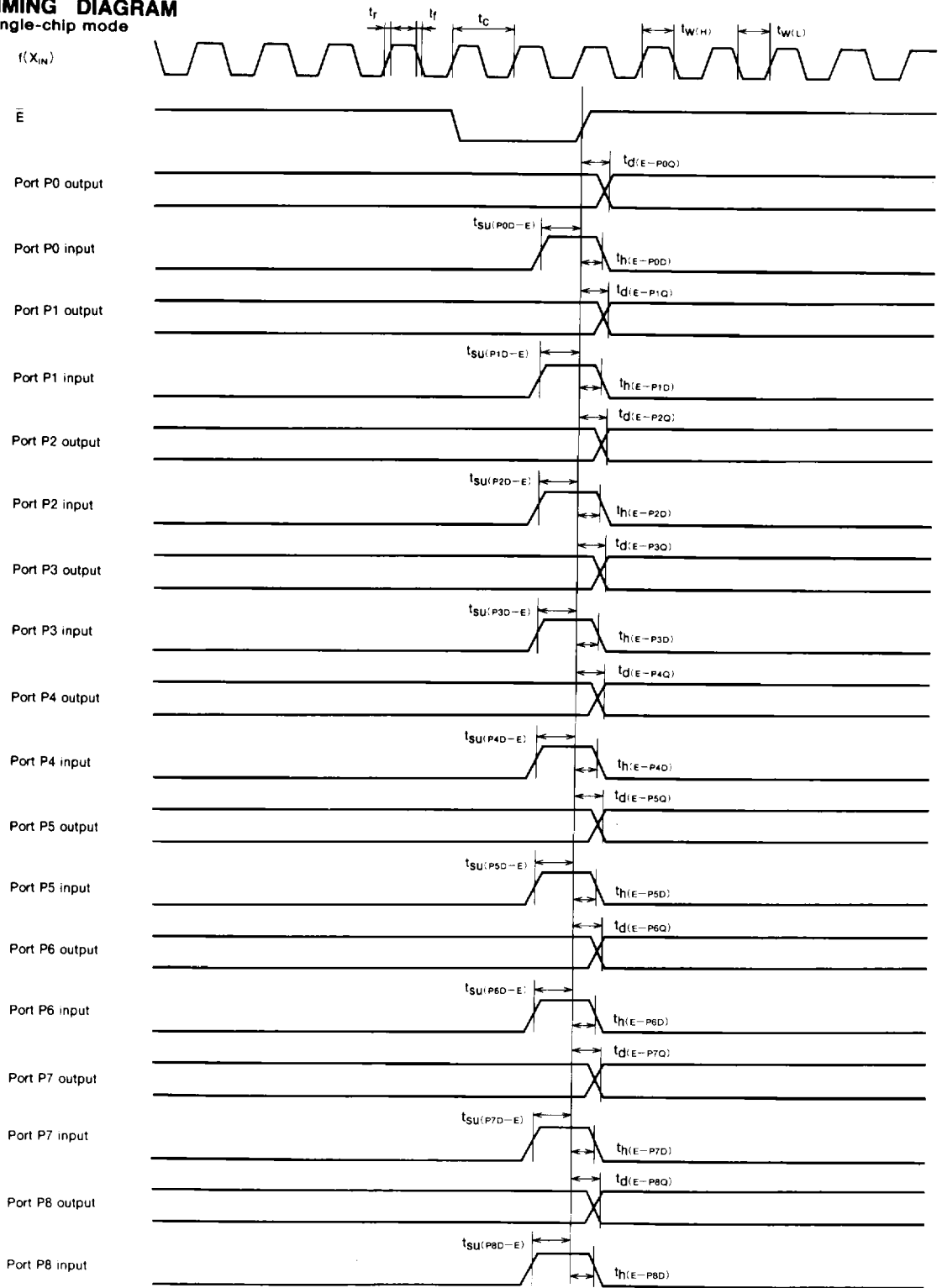

Fig. 3 Testing circuit for ports P0~P8, ϕ_1

TIMING DIAGRAM
Single-chip mode



MITSUBISHI MICROCOMPUTERS
M37710E8BXXFP
M37710E8BFS

PROM VERSION of M37710M8BXXFP

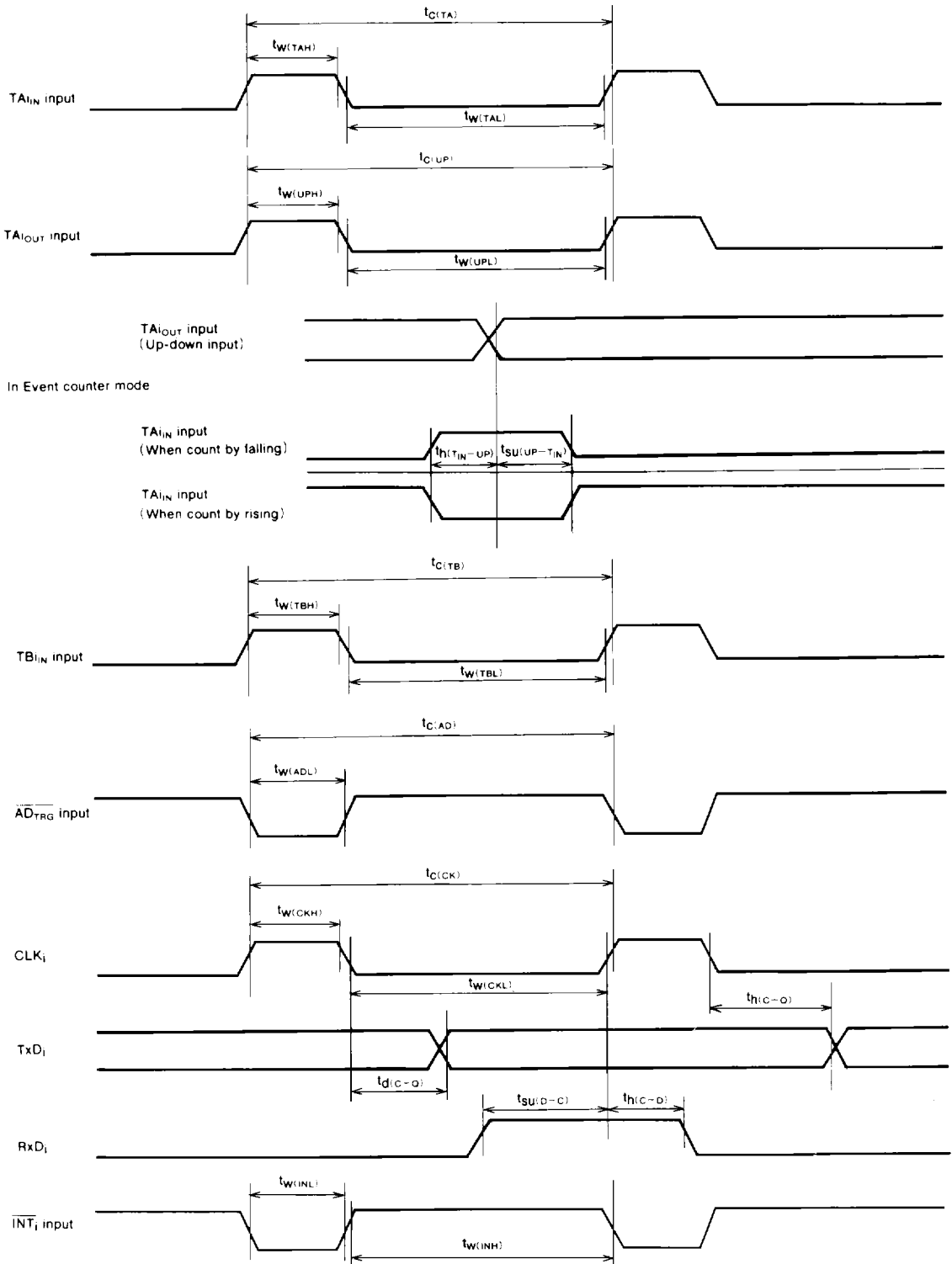

Memory expansion mode and microprocessor mode

(When wait bit = "1")

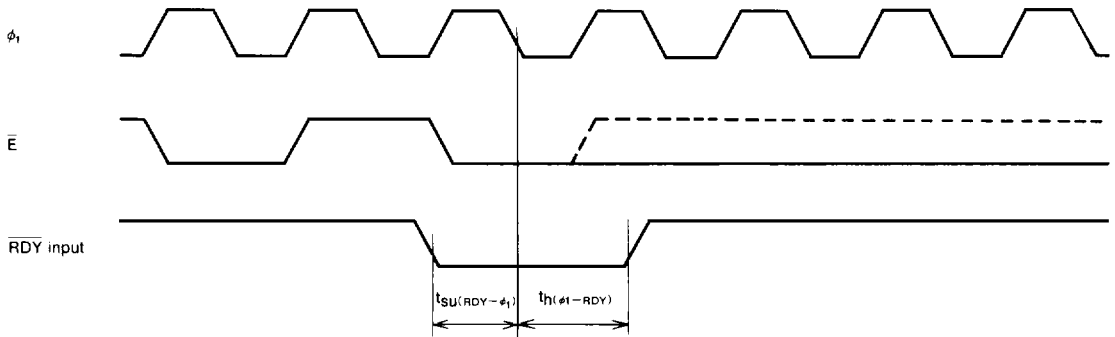

(When wait bit = "0")

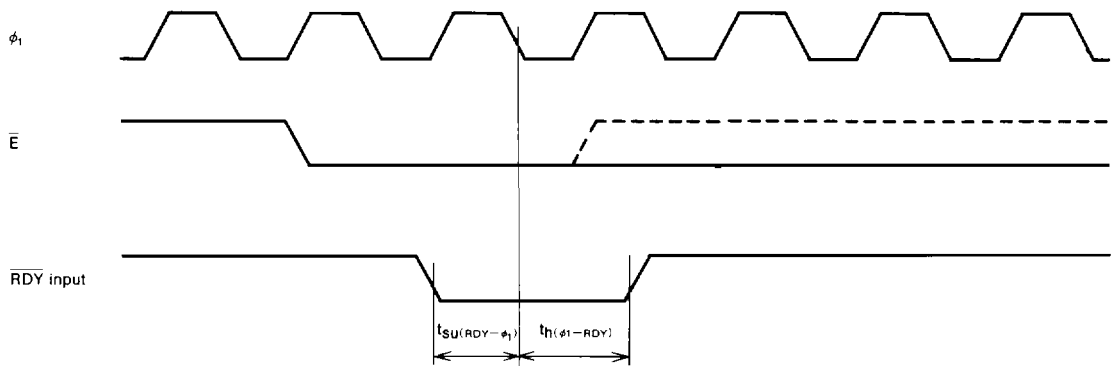

(When wait bit = "1" or "0" in common)

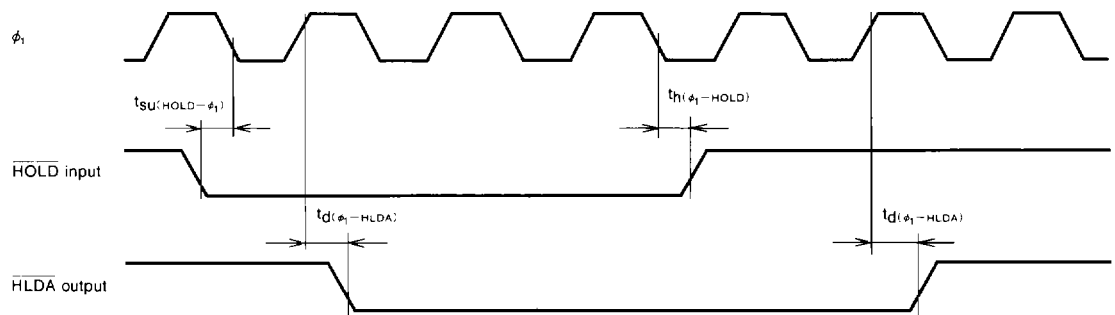

Test conditions

- $V_{CC} = 5V \pm 10\%$
- Input timing voltage : $V_{IL} = 1.0V, V_{IH} = 4.0V$
- Output timing voltage : $V_{OL} = 0.8V, V_{OH} = 2.0V$

MITSUBISHI MICROCOMPUTERS
M37710E8BXXFP
M37710E8BFS

PROM VERSION of M37710M8BXXFP

Memory expansion mode and microprocessor mode (When wait bit="1")

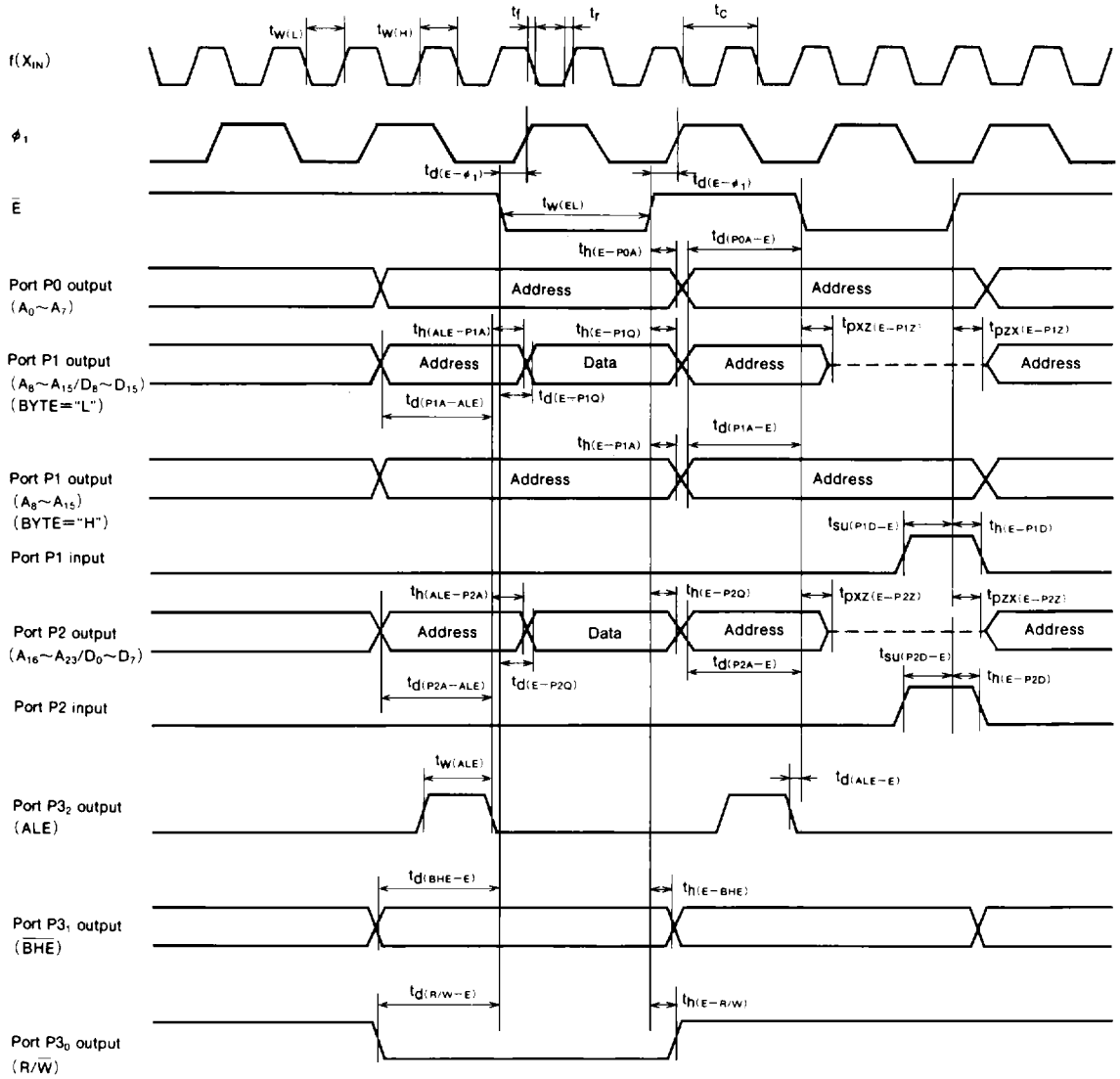

Test conditions

- $V_{CC}=5V \pm 10\%$
- Output timing voltage : $V_{OL}=0.8V, V_{OH}=2.0V$
- Ports P1, P2 input : $V_{IL}=0.8V, V_{IH}=2.5V$

MITSUBISHI MICROCOMPUTERS
M37710E8BXXFP
M37710E8BFS

PROM VERSION of M37710M8BXXFP

Memory expansion mode and microprocessor mode

(When wait bit = "0", wait selection bit = "1", and external memory area is accessed)

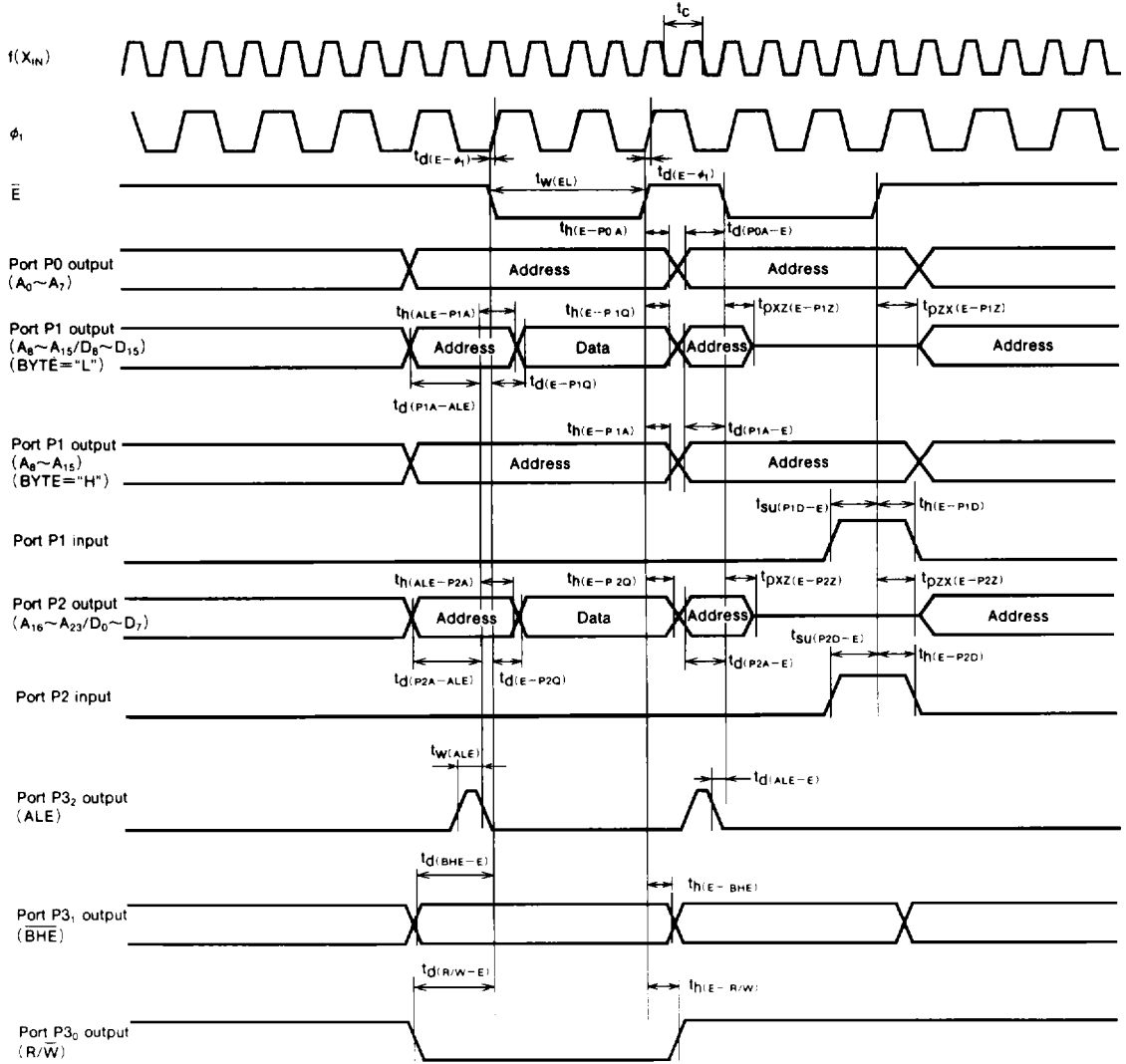

Test conditions

- $V_{CC} = 5V \pm 10\%$
- Output timing voltage : $V_{OL} = 0.8V, V_{OH} = 2.0V$
- Ports P1, P2 input : $V_{IL} = 0.8V, V_{IH} = 2.5V$

MITSUBISHI MICROCOMPUTERS
M37710E8BXXXFP
M37710E8BFS

PROM VERSION of M37710M8BXXXFP

Memory expansion mode and microprocessor mode

(When wait bit = "0", wait selection bit = "0", and external memory area is accessed)

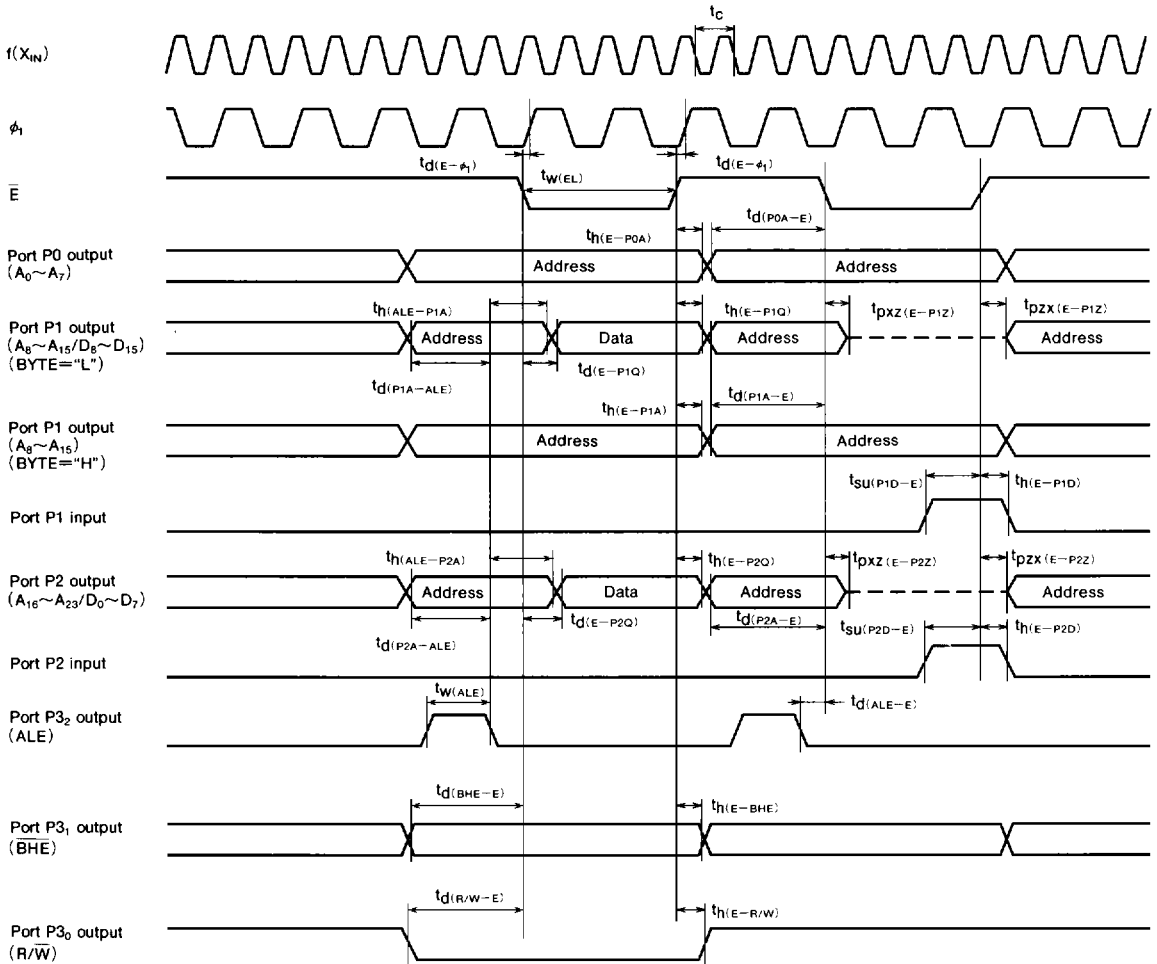

Test conditions

- $V_{CC}=5V \pm 10\%$
- Output timing voltage : $V_{OL}=0.8V, V_{OH}=2.0V$
- Ports P1, P2 input : $V_{IL}=0.8V, V_{IH}=2.5V$