



April 2014



# FDA8440

## N-Channel Logic Level PowerTrench<sup>®</sup> MOSFET

40 V, 100 A, 2.1 mΩ

### Features

- $R_{DS(on)} = 1.46 \text{ m}\Omega$  (Typ.) @  $V_{GS} = 10 \text{ V}$ ,  $I_D = 80 \text{ A}$
- $Q_{G(tot)} = 345 \text{ nC}$  (Typ.) @  $V_{GS} = 10 \text{ V}$
- Low Miller Charge
- Low  $Q_{rr}$  Body Diode
- UIS Capability (Single Pulse and Repetitive Pulse)
- 160 A Guarantee for 2 sec
- RoHS Compliant

### Application

- Power tools
- Motor drives and Uninterruptible Power Supplies
- Synchronous Rectification
- Battery Protection Circuit

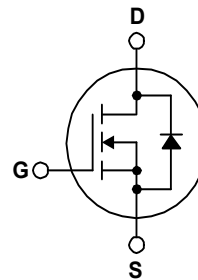
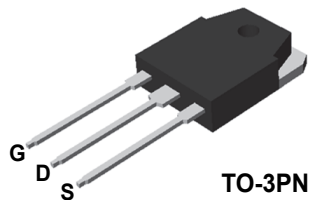

### MOSFET Maximum Ratings $T_C = 25^\circ\text{C}$ unless otherwise noted.

Symbol	Parameter	FDA8440	Unit
$V_{DSS}$	Drain to Source Voltage	40	V
$V_{GSS}$	Gate to Source Voltage	$\pm 20$	V
$I_D$	Drain Current - Continuous ( $T_C = 155^\circ\text{C}$ )	100	A
	- Continuous ( $T_A = 25^\circ\text{C}$ , $V_{GS} = 10 \text{ V}$ , $R_{\theta JA} = 40^\circ\text{C/W}$ )	30	A
	- Pulsed	500	A
$E_{AS}$	Single Pulsed Avalanche Energy (Note 1)	1682	mJ
$P_D$	Power dissipation	306	W
	Derate above $25^\circ\text{C}$	2.04	W/ $^\circ\text{C}$
$T_J, T_{STG}$	Operating and Storage Temperature	-55 to +175	$^\circ\text{C}$

### Thermal Characteristics

$R_{\theta JC}$	Thermal Resistance, Junction to Case, Max.	0.49	$^\circ\text{C/W}$
$R_{\theta JA}$	Thermal Resistance, Junction to Ambient, Max. (Note 2)	40	$^\circ\text{C/W}$

FDA8440 N-Channel Logic Level PowerTrench<sup>®</sup> MOSFET

## Package Marking and Ordering Information

Part Number	Top Mark	Package	Packing Method	Reel Size	Tape Width	Quantity
FDA8440	FDA8440	TO-3PN	Tube	N/A	N/A	30 units

## Electrical Characteristics T<sub>C</sub> = 25°C unless otherwise noted

Symbol	Parameter	Conditions	Min.	Typ.	Max.	Unit
<b>Off Characteristics</b>						
BV <sub>DSS</sub>	Drain to Source Breakdown Voltage	V <sub>GS</sub> = 0 V, I <sub>D</sub> = 250 μA	40	--	--	V
I <sub>DSS</sub>	Zero Gate Voltage Drain Current	V <sub>DS</sub> = 32 V	--	--	1	μA
		V <sub>GS</sub> = 0 V, T <sub>C</sub> = 150°C	--	--	250	μA
I <sub>GSS</sub>	Gate to Body Leakage Current	V <sub>GS</sub> = ±20 V	--	--	±100	nA
<b>On Characteristics</b>						
V <sub>GS(th)</sub>	Gate to Source Threshold Voltage	V <sub>DS</sub> = V <sub>GS</sub> , I <sub>D</sub> = 250 μA	1	--	3	V
R <sub>DS(on)</sub>	Static Drain-Source On-Resistance	V <sub>GS</sub> = 4.5 V, I <sub>D</sub> = 80 A	--	1.56	2.2	mΩ
		V <sub>GS</sub> = 10 V, I <sub>D</sub> = 80 A	--	1.46	2.1	
		V <sub>GS</sub> = 10 V, I <sub>D</sub> = 80 A, T <sub>C</sub> = 175°C	--	2.82	4.1	
<b>Dynamic Characteristics</b>						
C <sub>iss</sub>	Input Capacitance	V <sub>DS</sub> = 25 V, V <sub>GS</sub> = 0 V, f = 1 MHz	--	18600	24740	pF
C <sub>oss</sub>	Output Capacitance		--	1840	2450	pF
C <sub>rss</sub>	Reverse Transfer Capacitance		--	1400	2100	pF
R <sub>G</sub>	Gate Resistance	V <sub>GS</sub> = 0.5 V, f = 1 MHz	--	1.1	--	Ω
Q <sub>g(tot)</sub>	Total Gate Charge at 10V	V <sub>GS</sub> = 0 V to 10 V	--	345	450	nC
Q <sub>g(2)</sub>	Threshold Gate Charge	V <sub>GS</sub> = 0 V to 2 V	--	32.5	--	nC
Q <sub>gs</sub>	Gate to Source Gate Charge	V <sub>DD</sub> = 20 V I <sub>D</sub> = 80 A I <sub>g</sub> = 1.0 mA	--	49	--	nC
Q <sub>gs2</sub>	Gate Charge Threshold to Plateau		--	16.5	--	nC
Q <sub>gd</sub>	Gate to Drain "Miller" Charge		--	74	--	nC
<b>Switching Characteristics</b>						
t <sub>ON</sub>	Turn-On Time	V <sub>DD</sub> = 20 V, I <sub>D</sub> = 80 A V <sub>GS</sub> = 10 V, R <sub>GEN</sub> = 7 Ω	--	175	360	ns
t <sub>d(on)</sub>	Turn-On Delay Time		--	43	95	ns
t <sub>r</sub>	Rise Time		--	130	275	ns
t <sub>d(off)</sub>	Turn-Off Delay Time		--	435	875	ns
t <sub>f</sub>	Fall Time		--	290	590	ns
t <sub>OFF</sub>	Turn-Off Time		--	730	1470	ns
<b>Drain-Source Diode Characteristics and Maximum Ratings</b>						
V <sub>SD</sub>	Source to Drain Diode Voltage	I <sub>SD</sub> = 80 A	--	--	1.25	V
		I <sub>SD</sub> = 40 A	--	--	1.0	V
t <sub>rr</sub>	Reverse Recovery Time	I <sub>SD</sub> = 75 A, dI <sub>SD</sub> /dt = 100 A/μs	--	59	--	ns
Q <sub>RR</sub>	Reverse Recovery Charge	I <sub>SD</sub> = 75 A, dI <sub>SD</sub> /dt = 100 A/μs	--	77	--	nC

### NOTES:

- Starting T<sub>J</sub> = 25°C, L = 1 mH, I<sub>AS</sub> = 58 A, V<sub>DD</sub> = 36 V, V<sub>GS</sub> = 10 V.
- Pulse width = 100 s.

## Typical Performance Characteristics

**Figure 1. On-Region Characteristics**

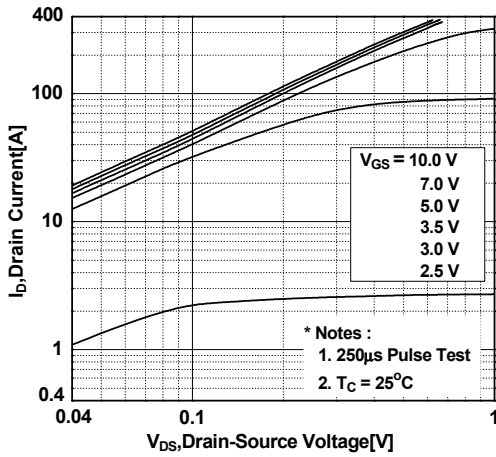

**Figure 2. Transfer Characteristics**

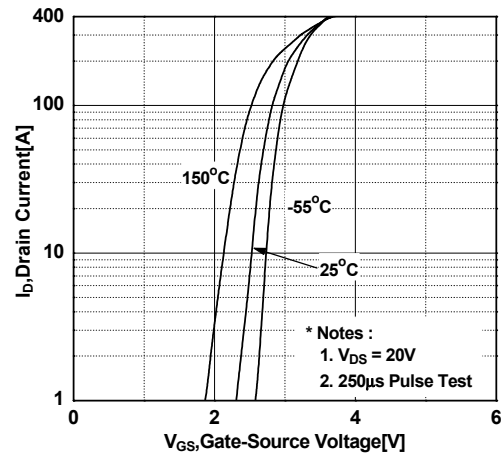

**Figure 3. On-Resistance Variation vs. Drain Current and Gate Voltage**

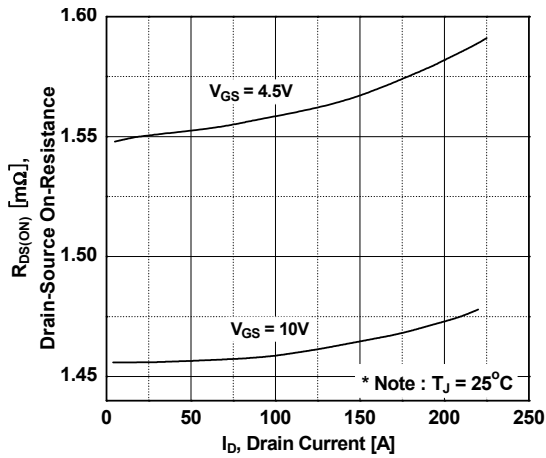

**Figure 4. Body Diode Forward Voltage Variation vs. Source Current and Temperature**

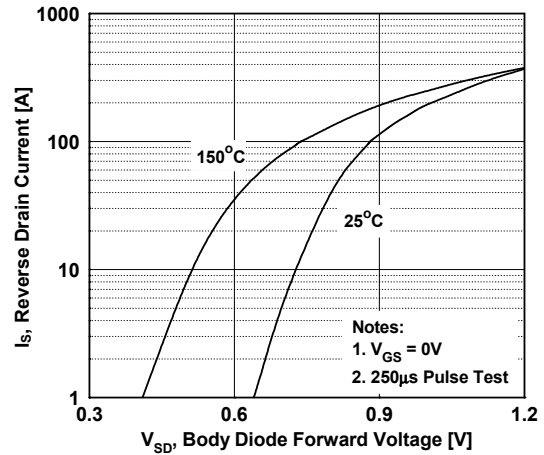

**Figure 5. Capacitance Characteristics**

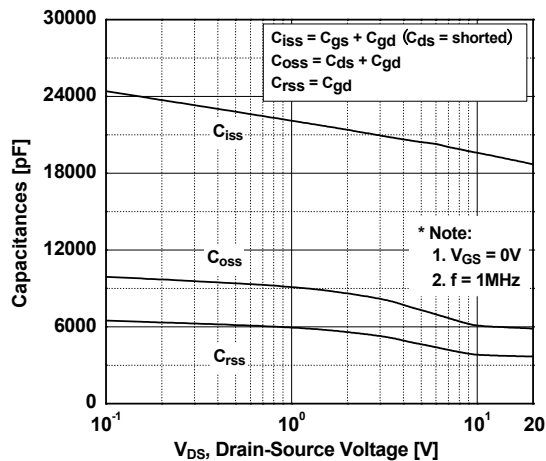

**Figure 6. Gate Charge Characteristics**

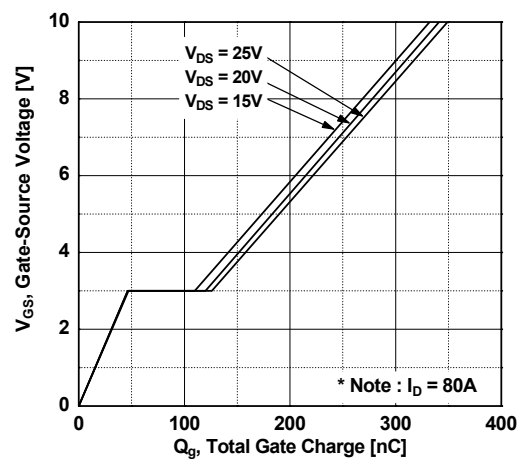

Typical Performance Characteristics (Continued)

Figure 7. Breakdown Voltage Variation vs. Temperature

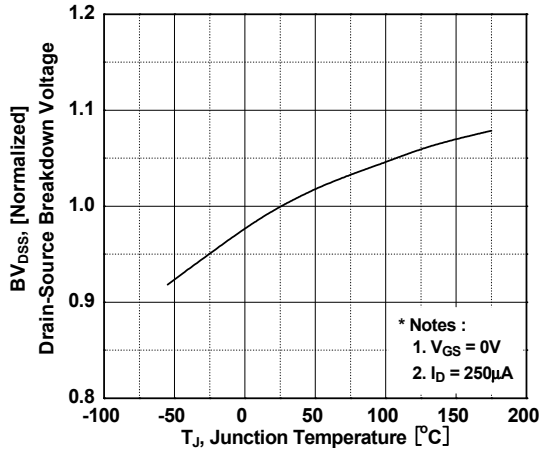

Figure 8. On-Resistance Variation vs. Temperature

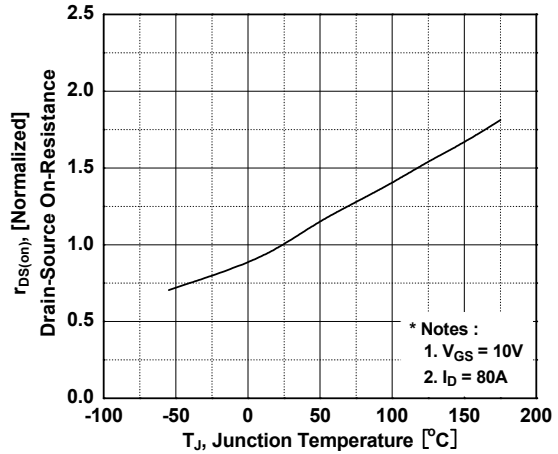

Figure 9. Unclamped Inductive Switching Capability

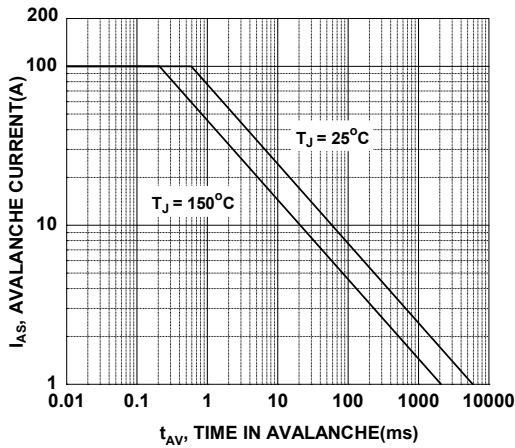

Figure 10. Safe Operating Area

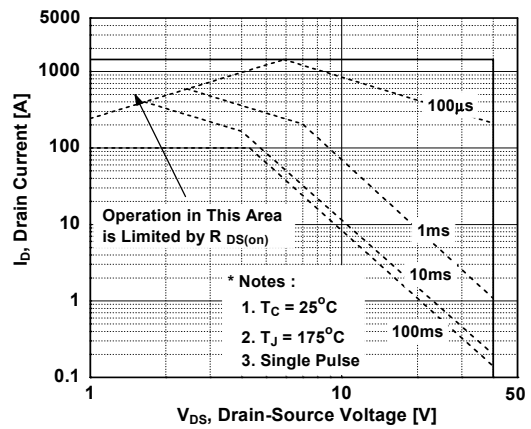
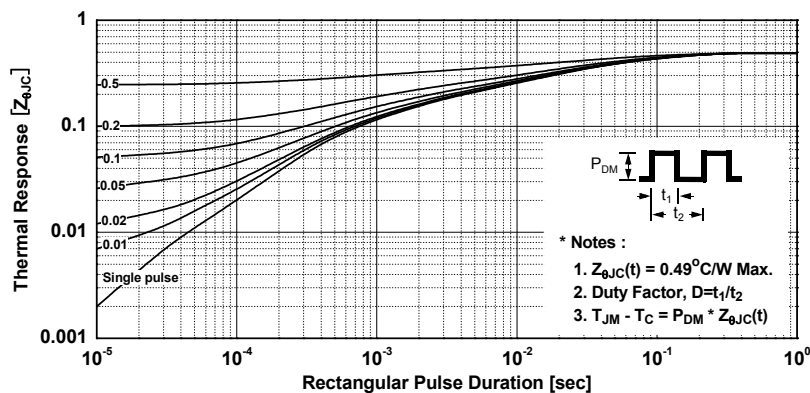

Figure 11. Transient Thermal Response Curve



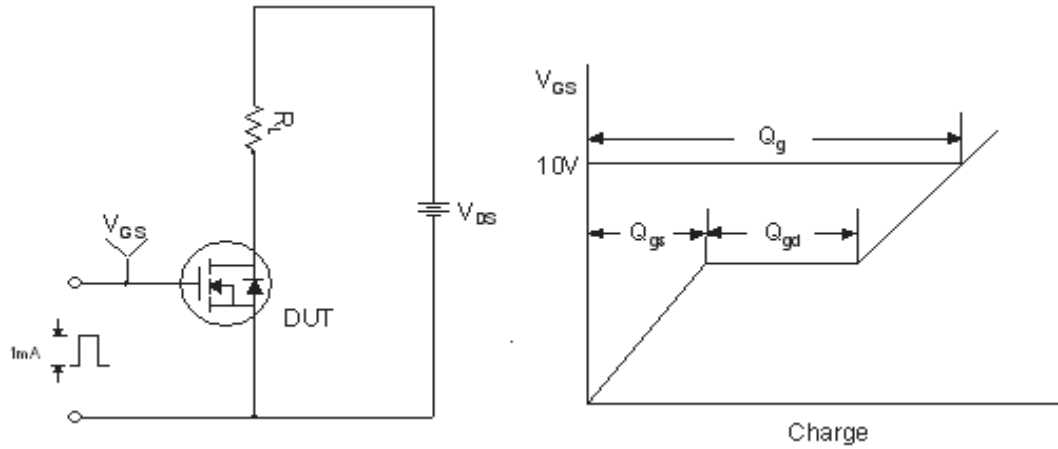

Figure 12. Gate Charge Test Circuit & Waveform

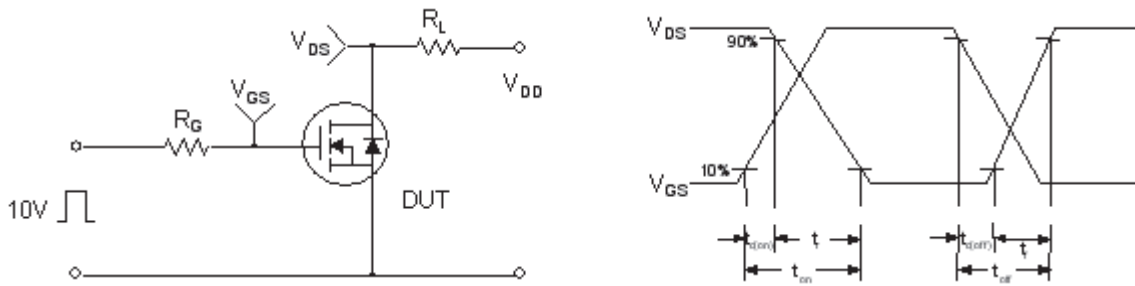

Figure 13. Resistive Switching Test Circuit & Waveforms

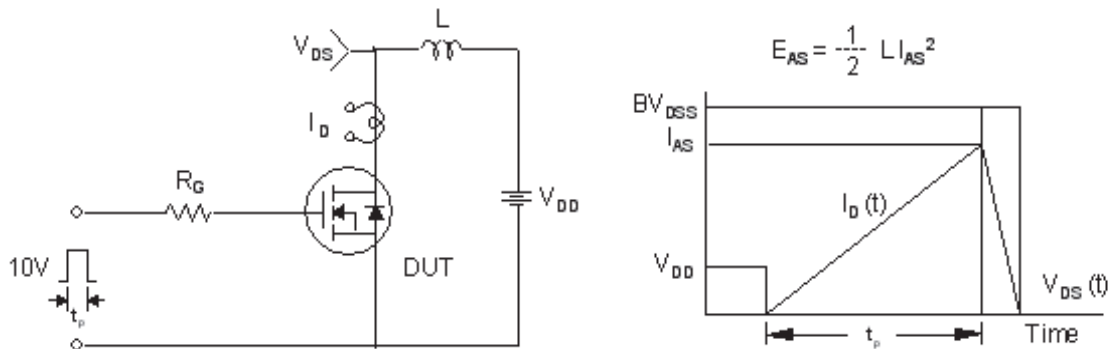

Figure 14. Unclamped Inductive Switching Test Circuit & Waveforms

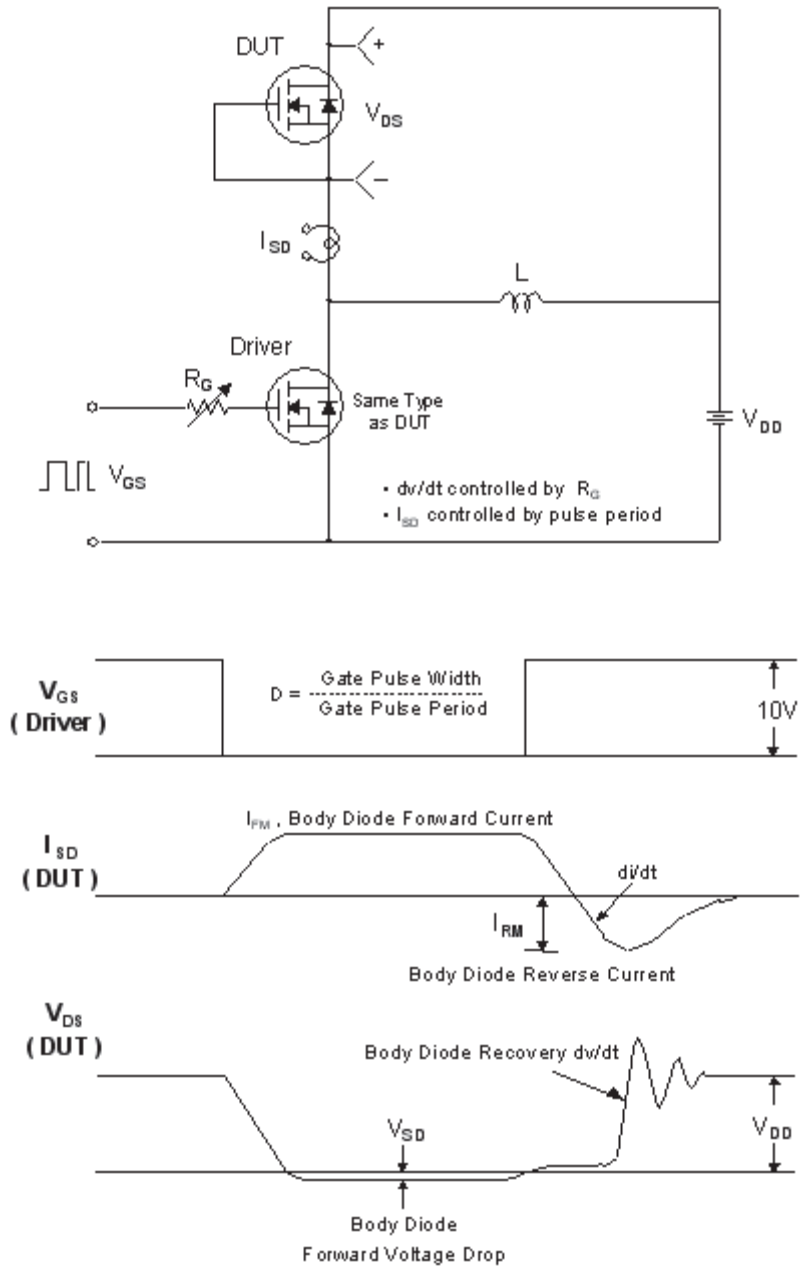
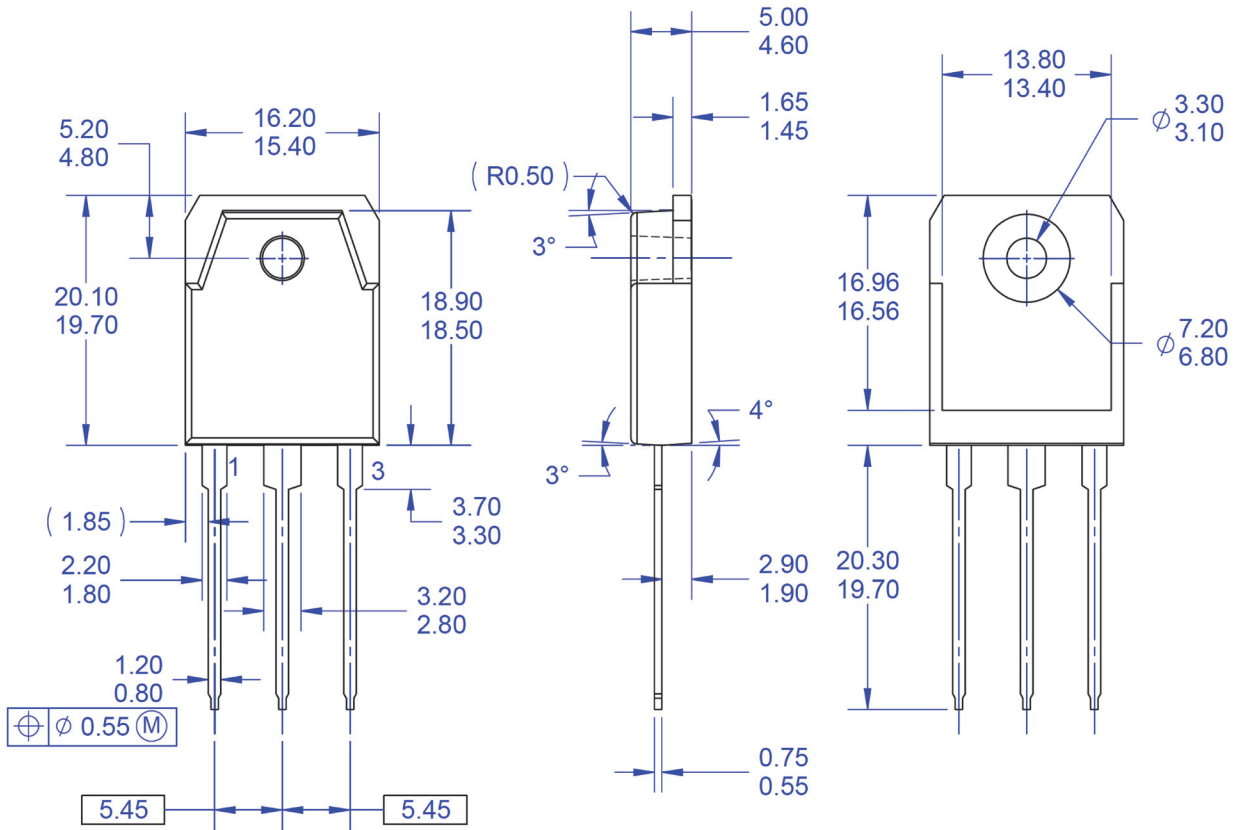

Figure 15. Peak Diode Recovery  $dv/dt$  Test Circuit & Waveforms

**Mechanical Dimensions**



NOTES: UNLESS OTHERWISE SPECIFIED

- A) THIS PACKAGE CONFORMS TO EIAJ SC-65 PACKAGING STANDARD.
- B) ALL DIMENSIONS ARE IN MILLIMETERS.
- C) DIMENSION AND TOLERANCING PER ASME14.5-2009.
- D) DIMENSIONS ARE EXCLUSIVE OF BURRS, MOLD FLASH, AND TIE BAR EXTRUSIONS.
- E) DRAWING FILE NAME: TO3PN03AREV1.
- F) FAIRCHILD SEMICONDUCTOR.

**Figure 16. TO3PN, 3-Lead, Plastic, EIAJ SC-65**

Package drawings are provided as a service to customers considering Fairchild components. Drawings may change in any manner without notice. Please note the revision and/or date on the drawing and contact a Fairchild Semiconductor representative to verify or obtain the most recent revision. Package specifications do not expand the terms of Fairchild's worldwide terms and conditions, specifically the warranty therein, which covers Fairchild products.

Always visit Fairchild Semiconductor's online packaging area for the most recent package drawings:

[http://www.fairchildsemi.com/package/packageDetails.html?id=PN\\_TT3PN-003](http://www.fairchildsemi.com/package/packageDetails.html?id=PN_TT3PN-003)



**TRADEMARKS**

The following includes registered and unregistered trademarks and service marks, owned by Fairchild Semiconductor and/or its global subsidiaries, and is not intended to be an exhaustive list of all such trademarks.

- |   |   |                             |                  |
|---|---|-----------------------------|------------------|
| AccuPower™  | F-PFS™  | PowerTrench®                | SYSTEM GENERAL®  |
| AX-CAP®*  | FRFET®  | PowerXS™                    | TinyBoost®       |
| BitSiC™   | Global Power ResourceSM                         | Programmable Active Droop™  | TinyBuck®        |
| Build it Now™   | GreenBridge™                                    | QFET®                       | TinyCalc™        |
| CorePLUS™   | Green FPS™                                      | QS™                         | TinyLogic®       |
| CorePOWER™  | Green FPS™ e-Series™                            | Quiet Series™               | TINYOPTO™        |
| CROSSVOLT™  | Gmax™   | RapidConfigure™             | TinyPower™       |
| CTL™  | GTO™  | SmartMax™                   | TinyPWM™         |
| Current Transfer Logic™   | IntelliMAX™                                     | SMART START™                | TinyWire™        |
| DEUXPEED®   | ISOPLANAR™                                      | Solutions for Your Success™ | TranSiC™         |
| Dual Cool™  | Marking Small Speakers Sound Louder and Better™ | SPM®                        | TriFault Detect™ |
| EcoSPARK®   | MegaBuck™                                       | STEALTH™                    | TRUECURRENT®*    |
| EfficientMax™   | MICROCOUPLER™                                   | SuperFET®                   | µSerDes™         |
| ESBC™   | MicroFET™                                       | SuperSOT™-3                 | UHC®             |
|  | MicroPak™                                       | SuperSOT™-6                 | Ultra FRFET™     |
| Fairchild®  | MicroPak2™                                      | SuperSOT™-8                 | UniFET™          |
| Fairchild Semiconductor®  | MillerDrive™                                    | SupreMOS®                   | VCX™             |
| FACT Quiet Series™  | MotionMax™                                      | SyncFET™                    | VisualMax™       |
| FACT®   | mWSaver®  | Sync-Lock™                  | VoltagePlus™     |
| FAST®   | OptoHiT™  |                             | XS™              |
| FastvCore™  | OPTOLOGIC®                                      |                             | ? ? ™            |
| FETBench™   | OPTOPLANAR®                                     |                             |                  |
| FPS™  |   |                             |                  |

\*Trademarks of System General Corporation, used under license by Fairchild Semiconductor.

**DISCLAIMER**

FAIRCHILD SEMICONDUCTOR RESERVES THE RIGHT TO MAKE CHANGES WITHOUT FURTHER NOTICE TO ANY PRODUCTS HEREIN TO IMPROVE RELIABILITY, FUNCTION, OR DESIGN. FAIRCHILD DOES NOT ASSUME ANY LIABILITY ARISING OUT OF THE APPLICATION OR USE OF ANY PRODUCT OR CIRCUIT DESCRIBED HEREIN; NEITHER DOES IT CONVEY ANY LICENSE UNDER ITS PATENT RIGHTS, NOR THE RIGHTS OF OTHERS. THESE SPECIFICATIONS DO NOT EXPAND THE TERMS OF FAIRCHILD'S WORLDWIDE TERMS AND CONDITIONS, SPECIFICALLY THE WARRANTY THEREIN, WHICH COVERS THESE PRODUCTS.

**LIFE SUPPORT POLICY**

FAIRCHILD'S PRODUCTS ARE NOT AUTHORIZED FOR USE AS CRITICAL COMPONENTS IN LIFE SUPPORT DEVICES OR SYSTEMS WITHOUT THE EXPRESS WRITTEN APPROVAL OF FAIRCHILD SEMICONDUCTOR CORPORATION.

As used here in:

- Life support devices or systems are devices or systems which, (a) are intended for surgical implant into the body or (b) support or sustain life, and (c) whose failure to perform when properly used in accordance with instructions for use provided in the labeling, can be reasonably expected to result in a significant injury of the user.
- A critical component in any component of a life support, device, or system whose failure to perform can be reasonably expected to cause the failure of the life support device or system, or to affect its safety or effectiveness.

**ANTI-COUNTERFEITING POLICY**

Fairchild Semiconductor Corporation's Anti-Counterfeiting Policy. Fairchild's Anti-Counterfeiting Policy is also stated on our external website, [www.fairchildsemi.com](http://www.fairchildsemi.com), under Sales Support.

Counterfeiting of semiconductor parts is a growing problem in the industry. All manufactures of semiconductor products are experiencing counterfeiting of their parts. Customers who inadvertently purchase counterfeit parts experience many problems such as loss of brand reputation, substandard performance, failed application, and increased cost of production and manufacturing delays. Fairchild is taking strong measures to protect ourselves and our customers from the proliferation of counterfeit parts. Fairchild strongly encourages customers to purchase Fairchild parts either directly from Fairchild or from Authorized Fairchild Distributors who are listed by country on our web page cited above. Products customers buy either from Fairchild directly or from Authorized Fairchild Distributors are genuine parts, have full traceability, meet Fairchild's quality standards for handling and storage and provide access to Fairchild's full range of up-to-date technical and product information. Fairchild and our Authorized Distributors will stand behind all warranties and will appropriately address and warranty issues that may arise. Fairchild will not provide any warranty coverage or other assistance for parts bought from Unauthorized Sources. Fairchild is committed to combat this global problem and encourage our customers to do their part in stopping this practice by buying direct or from authorized distributors.

**PRODUCT STATUS DEFINITIONS**

**Definition of Terms**

Datasheet Identification	Product Status	Definition
Advance Information	Formative / In Design	Datasheet contains the design specifications for product development. Specifications may change in any manner without notice.
Preliminary	First Production	Datasheet contains preliminary data; supplementary data will be published at a later date. Fairchild Semiconductor reserves the right to make changes at any time without notice to improve design.
No Identification Needed	Full Production	Datasheet contains final specifications. Fairchild Semiconductor reserves the right to make changes at any time without notice to improve the design.
Obsolete	Not In Production	Datasheet contains specifications on a product that is discontinued by Fairchild Semiconductor. The datasheet is for reference information only.