



Features

- Automatic power-down when deselected
- Output Enable (\overline{OE}) feature (7C195 and 7C196)
- CMOS for optimum speed/power
- High speed
— $t_{AA} = 25$ ns
- Low active power
— 880 mW
- Low standby power
— 220 mW
- TTL-compatible inputs and outputs

- Capable of withstanding greater than 2001V electrostatic discharge

Functional Description

The CY7C194, CY7C195, and CY7C196 are high-performance CMOS static RAMs organized as 65,536 by 4 bits. Easy memory expansion is provided by active LOW chip enable(s) (\overline{CE} on the CY7C194 and CY7C195, \overline{CE}_1 , \overline{CE}_2 on the CY7C196) and three-state drivers. They have an automatic power-down feature, reducing the power consumption by 75% when deselected.

Writing to the device is accomplished when the chip enable(s) (\overline{CE} on the CY7C194

and CY7C195, \overline{CE}_1 , \overline{CE}_2 on the CY7C196) and write enable (\overline{WE}) inputs are both LOW. Data on the four input pins (I/O_0 through I/O_3) is written into the memory location, specified on the address pins (A_0 through A_{15}).

Reading the device is accomplished by taking the chip enable(s) (\overline{CE} on the CY7C194 and CY7C195, \overline{CE}_1 , \overline{CE}_2 on the CY7C196) LOW, while write enable (\overline{WE}) remains HIGH. Under these conditions the contents of the memory location specified on the address pins will appear on the four data output pins.

A die coat is used to ensure alpha immunity.

Logic Block Diagram

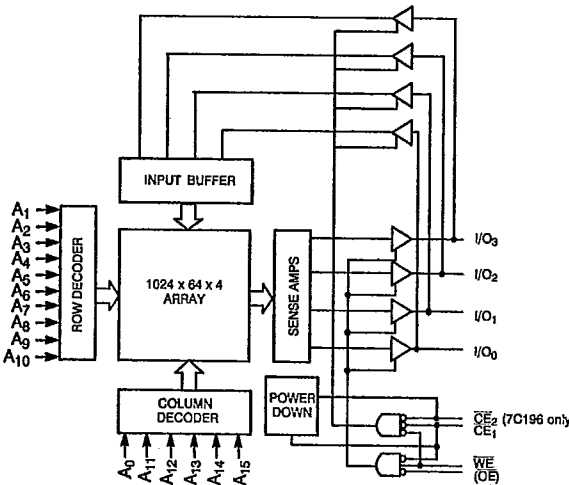

Pin Configurations

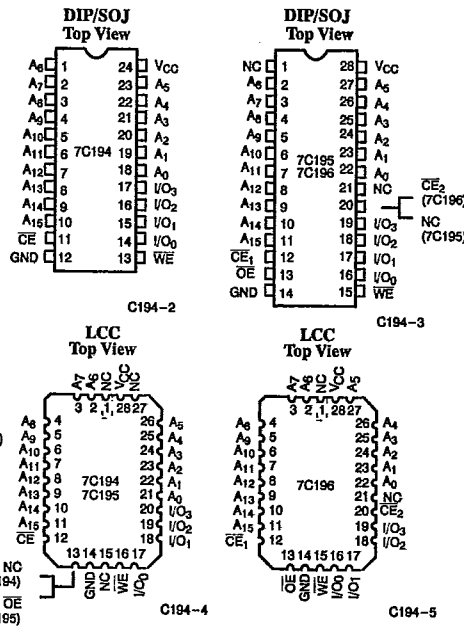

Selection Guide

	7C194-12 7C195-12 7C196-12	7C194-15 7C195-15 7C196-15	7C194-20 7C195-20 7C196-20	7C194-25 7C195-25 7C196-25	7C194-35 7C195-35 7C196-35	7C194-45 7C195-45 7C196-45
Maximum Access Time (ns)	12	15	20	25	35	45
Maximum Operating Current (mA)	Commercial	160	150	140	120	120
	Military		160	150	130	130
Maximum Standby Current (mA)	40	40	40	35	35	35

Shaded area contains advanced information.



CYPRESS SEMICONDUCTOR

T-46-23-10

Maximum Ratings

(Above which the useful life may be impaired. For user guidelines, not tested.)

- Storage Temperature - 65°C to +150°C
- Ambient Temperature with Power Applied - 55°C to +125°C
- Supply Voltage to Ground Potential - 0.5V to +7.0V
- DC Voltage Applied to Outputs in High Z State - 0.5V to +7.0V
- DC Input Voltage - 3.0V to +7.0V
- Output Current into Outputs (LOW) 20 mA

Static Discharge Voltage >2001V
(per MIL-STD-883, Method 3015)

Latch-Up Current >200 mA

Operating Range

Range	Ambient Temperature ^[1]	V _{CC}
Commercial	0°C to +70°C	5V ± 10%
Military	- 55°C to +125°C	5V ± 10%



SRAMS

Electrical Characteristics Over the Operating Range^[2]

Parameters	Description	Test Conditions	7C194-12 7C195-12 7C196-12		7C194-15 7C195-15 7C196-15		Units
			Min.	Max.	Min.	Max.	
V _{OH}	Output HIGH Voltage	V _{CC} = Min., I _{OH} = - 4.0 mA	2.4		2.4		V
V _{OL}	Output LOW Voltage	V _{CC} = Min., I _{OL} = 8.0 mA		0.4		0.4	V
V _{IH}	Input HIGH Voltage		2.2	V _{CC}	2.2	V _{CC}	V
V _{IL}	Input LOW Voltage		-0.5	0.8	-0.5	0.8	V
I _{IX}	Input Load Current	GND ≤ V _I ≤ V _{CC}	-10	+10	-10	+10	µA
I _{OZ}	Output Leakage Current	GND ≤ V _O ≤ V _{CC} , Output Disabled	-10	+10	-10	+10	µA
I _{OS}	Output Short Circuit Current ^[3]	V _{CC} = Max., V _{OUT} = GND		-300		-300	mA
I _{CC}	V _{CC} Operating Supply Current	V _{CC} = Max., I _{OUT} = 0 mA, f = f _{MAX} = 1/t _{RC}	Com'l	160		150	mA
			Mil			160	
I _{SB1}	Automatic \overline{CE} Power-Down Current -TTL Inputs ^[4]	Max. V _{CC} , $\overline{CE}_{1,2} \geq V_{IH}$, V _{IN} ≥ V _{IH} or V _{IN} ≤ V _{IL} , f = f _{MAX}		40		40	mA
I _{SB2}	Automatic \overline{CE} Power-Down Current -CMOS Inputs ^[4]	Max. V _{CC} , $\overline{CE}_{1,2} \geq V_{CC} - 0.3V$, V _{IN} ≥ V _{CC} - 0.3V or V _{IN} ≤ 0.3V, f = 0		20		20	mA

Shaded area contains advanced information.

- Notes:**
1. T_A is the "instant on" case temperature.
 2. See the last page of this specification for Group A subgroup testing information.
 3. Not more than 1 output should be shorted at one time. Duration of the short circuit should not exceed 30 seconds.
 4. A pull-up resistor to V_{CC} on the \overline{CE} input is required to keep the device deselected during V_{CC} power-up, otherwise I_{SB} will exceed values given.



CYPRESS SEMICONDUCTOR

T-46-23-10

Electrical Characteristics Over the Operating Range^[2](continued)

Parameters	Description	Test Conditions	7C194-20 7C195-20 7C196-20		7C194-25, 35, 45 7C195-25, 35, 45 7C196-25, 35, 45		Units
			Min.	Max.	Min.	Max.	
V _{OH}	Output HIGH Voltage	V _{CC} = Min., I _{OH} = -4.0 mA	2.4		2.4		V
V _{OL}	Output LOW Voltage	V _{CC} = Min., I _{OL} = 8.0 mA		0.4		0.4	V
V _{IH}	Input HIGH Voltage		2.2	V _{CC}	2.2	V _{CC}	V
V _{IL}	Input LOW Voltage		-0.5	0.8	-3.0	0.8	V
I _{Ix}	Input Load Current	GND ≤ V _I ≤ V _{CC}	-10	+10	-10	+10	μA
I _{OZ}	Output Leakage Current	GND ≤ V _O ≤ V _{CC} , Output Disabled	-10	+10	-10	+10	μA
I _{OS}	Output Short Circuit Current ^[3]	V _{CC} = Max., V _{OUT} = GND		-350		-350	mA
I _{CC}	V _{CC} Operating Supply Current	V _{CC} = Max., I _{OUT} = 0 mA, f = f _{MAX} = 1/t _{RC}	Com'l	140		120	mA
			Mil	150		130	
I _{SB1}	Automatic CE Power-Down Current —TTL Inputs ^[4]	Max. V _{CC} , CE _{1,2} ≥ V _{IH} , V _{IN} ≥ V _{IH} or V _{IN} ≤ V _{IL} , f = f _{MAX}		40		35	mA
I _{SB2}	Automatic CE Power-Down Current —CMOS Inputs ^[4]	Max. V _{CC} , CE _{1,2} ≥ V _{CC} - 0.3V, V _{IN} ≥ V _{CC} - 0.3V or V _{IN} ≤ 0.3V, f = 0		20		20	mA

Shaded area contains advanced information.

Capacitance^[5]

Parameters	Description	Test Conditions	Max.	Units
C _{IN}	Input Capacitance	T _A = 25°C, f = 1 MHz, V _{CC} = 5.0V	10	pF
C _{OUT}	Output Capacitance		10	pF

Note:
5. Tested initially and after any design or process changes that may affect these parameters.

AC Test Loads and Waveforms

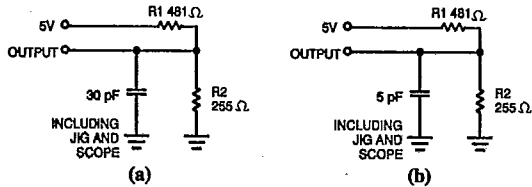

C194-6

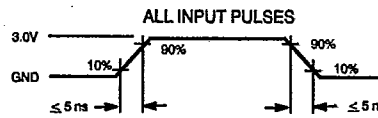

C194-7

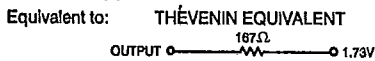



CYPRESS SEMICONDUCTOR

T-46-23-10

Switching Characteristics Over the Operating Range^[2,6]

Parameters	Description	7C194-12		7C194-15		7C194-20		7C194-25		7C194-35		7C194-45		Units
		Min.	Max.	Min.	Max.	Min.	Max.	Min.	Max.	Min.	Max.	Min.	Max.	
READ CYCLE														
t _{RC}	Read Cycle Time	12		15		20		25		35		45		ns
t _{AA}	Address to Data Valid		12		15		20		25		35		45	ns
t _{OHA}	Output Hold from Address Change	3		3		3		3		3		3		ns
t _{ACE1} , t _{ACE2}	\overline{CE} LOW to Data Valid		12		15		20		25		35		45	ns
t _{DOE}	\overline{OE} LOW to Data Valid		6		8		10		15		20		20	ns
t _{LZOE}	\overline{OE} LOW to Low Z		0		0		0		3		3		3	ns
t _{HZOE}	\overline{OE} HIGH to High Z ^[8]		7		8		8		13		15		20	ns
t _{LZCE1} , t _{LZCE2}	\overline{CE} LOW to Low Z ^[7]	3		3		3		3		3		3		ns
t _{HZCE1} , t _{HZCE2}	\overline{CE} HIGH to High Z ^[7,8]		7		8		10		13		15		20	ns
t _{PU}	\overline{CE} LOW to Power-Up	0		0		0		0		0		0		ns
t _{PD}	\overline{CE} HIGH to Power-Down		12		15		20		25		35		45	ns
WRITE CYCLE^[9]														
t _{WC}	Write Cycle Time	12		15		20		25		35		45		ns
t _{SCE}	\overline{CE} LOW to Write End	9		10		15		20		30		40		ns
t _{AW}	Address Set-Up to Write End	9		10		15		20		25		35		ns
t _{HA}	Address Hold from Write End	0		0		0		0		0		0		ns
t _{SA}	Address Set-Up to Write Start	0		0		0		0		0		0		ns
t _{PWE}	\overline{WE} Pulse Width	9		10		15		20		25		30		ns
t _{SD}	Data Set-Up to Write End	7		8		10		15		17		20		ns
t _{HD}	Data Hold from Write End	0		0		0		0		0		0		ns
t _{LZWE}	\overline{WE} HIGH to Low Z ^[7]	3		3		3		3		3		3		ns
t _{HZWE}	\overline{WE} LOW to High Z ^[7,8]		7		7		10		13		15		20	ns

Notes:

6. Test conditions assume signal transition time of 5 ns or less, timing reference levels of 1.5V, input pulse levels of 0 to 3.0V, and output loading of the specified I_{OL}/I_{OH} and 30 pF load capacitance.
7. At any given temperature and voltage condition, t_{HZCE} is less than t_{LZCE} and t_{HZWE} is less than t_{LZWE} for any given device.
8. t_{HZOE}, t_{HZCE}, and t_{HZWE} are specified with C_L = 5 pF as in part (b) of AC Test Loads. Transition is measured ±500 mV from steady state voltage.

9. The internal write time of the memory is defined by the overlap of \overline{CE}_1 LOW, \overline{CE}_2 LOW, and \overline{WE} LOW. All signals must be LOW to initiate a write and any signal can terminate a write by going HIGH. The data input set-up and hold timing should be referenced to the rising edge of the signal that terminates the write.

SRAMS



Switching Waveforms

Read Cycle No. 1^[10, 11]

T-46-23-10

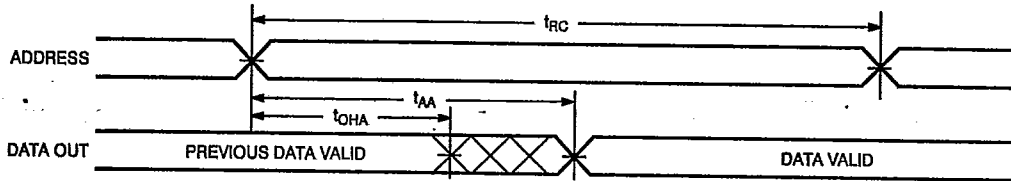

C194-8

Read Cycle No. 2^[10, 12]

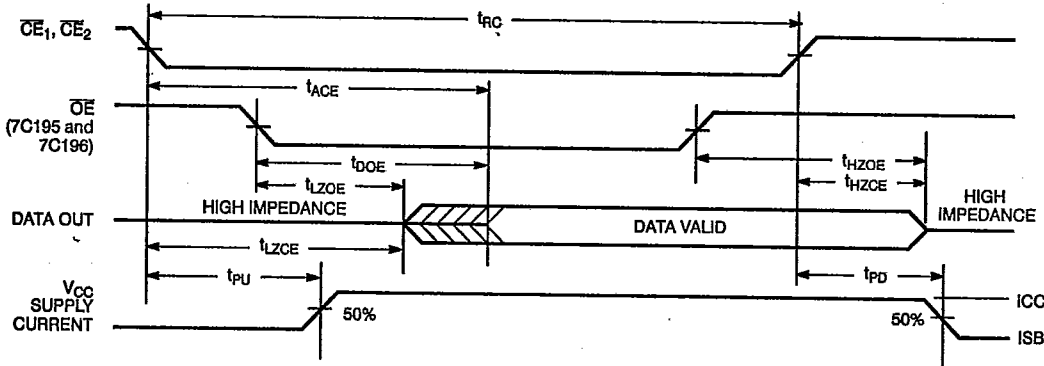

C194-9

Write Cycle No. 1 (\overline{CE} Controlled)^[9, 13, 14]

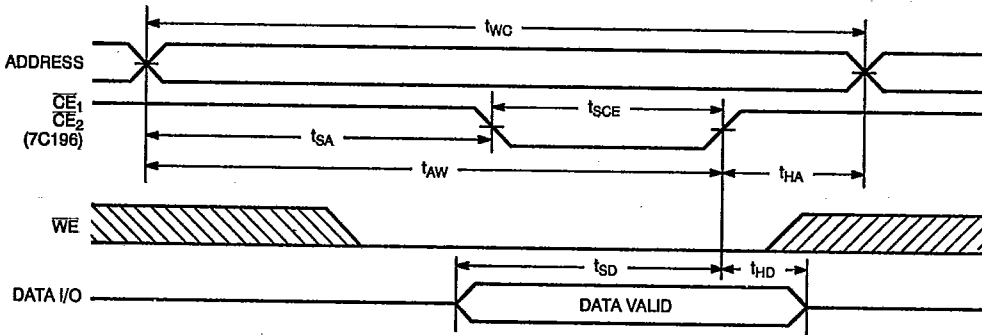

C194-10

Notes:

10. \overline{WE} is HIGH for read cycle.
11. Device is continuously selected: $\overline{CE}_1 = V_{IL}, \overline{CE}_2 = V_{IL}$ (7C196), and $\overline{OE} = V_{IL}$ (7C195 and 7C196).
12. Address valid prior to or coincident with \overline{CE}_1 and \overline{CE}_2 transition LOW.
13. Data I/O will be high impedance if $\overline{OE} = V_{IH}$ (7C195 and 7C196).
14. If any \overline{CE} goes HIGH simultaneously with \overline{WE} HIGH, the output remains in a high-impedance state.
15. The minimum write cycle time for Write Cycle No. 3 (\overline{WE} controlled, \overline{OE} LOW) is the sum of t_{HZWE} and t_{SD} .



Switching Waveforms (continued)

T-46-23-10

Write Cycle No. 2 (\overline{WE} Controlled, \overline{OE} HIGH During Write for 7C195 and 7C196 only)^[9, 13, 14]

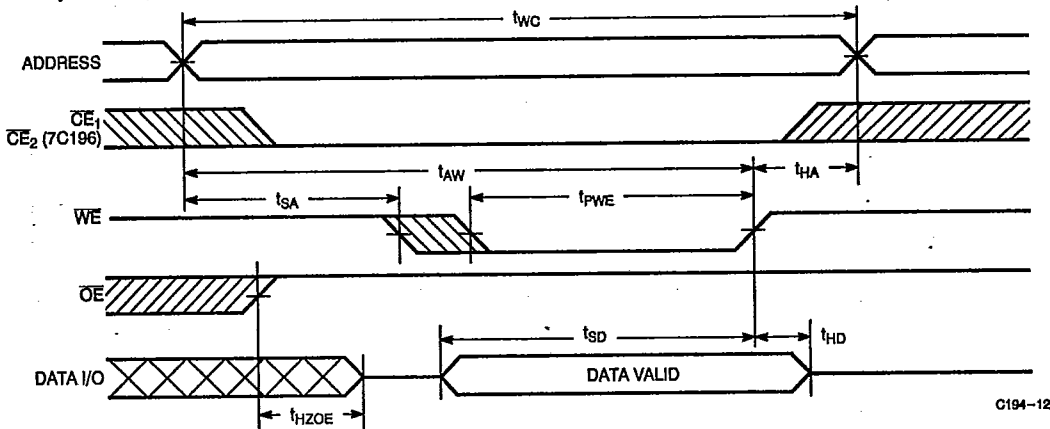

C194-12

Write Cycle No. 3 (\overline{WE} Controlled, \overline{OE} LOW)^[14, 15]

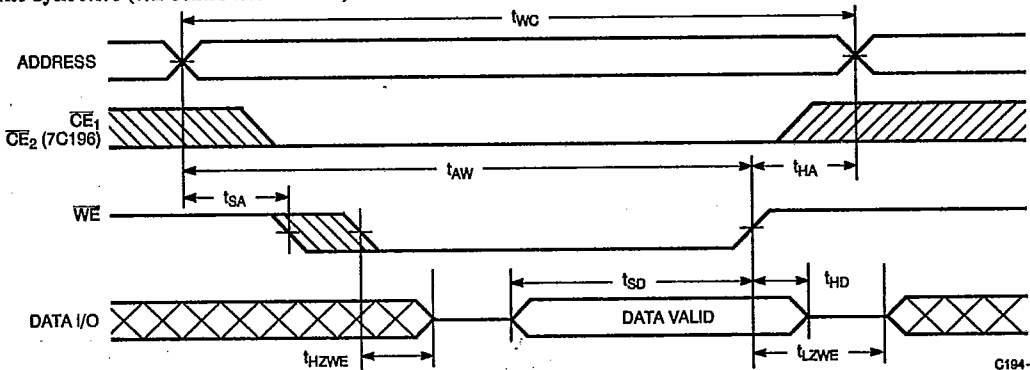

C194-11

Typical DC and AC Characteristics

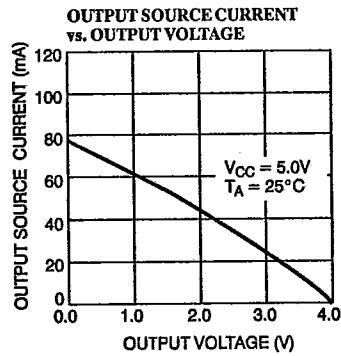
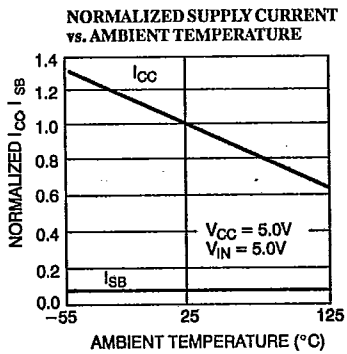
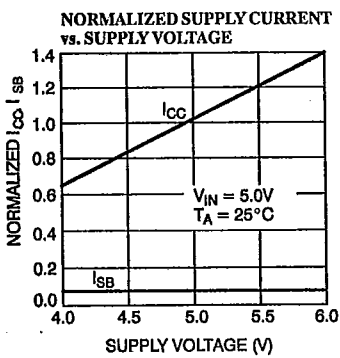



T-46-23-10

Typical DC and AC Characteristics (continued)

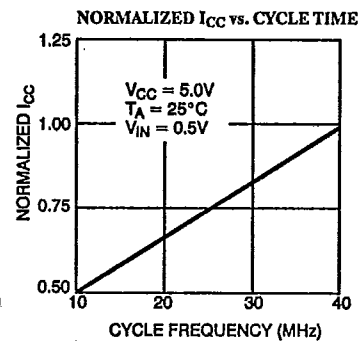
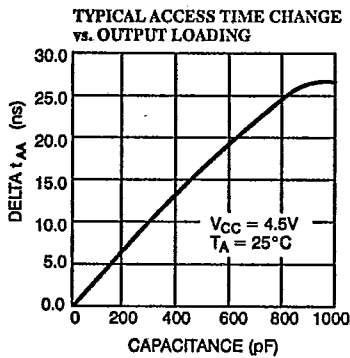
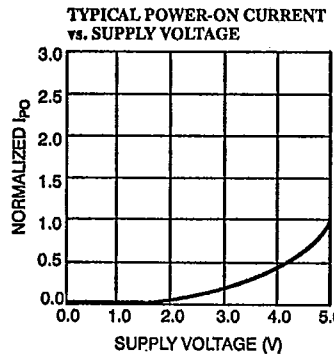
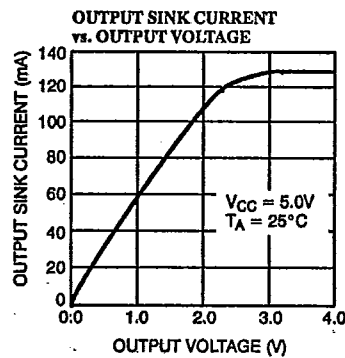
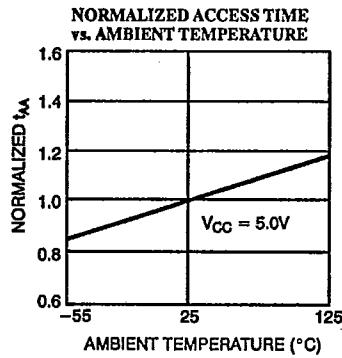
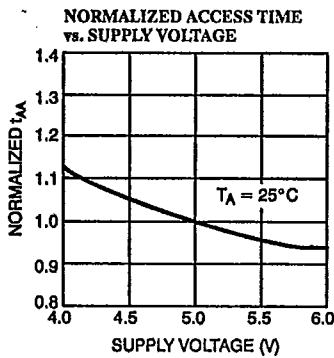

7C194 Truth Table

CE	WE	Data I/O	Mode	Power
H	X	High Z	Deselect/Power-Down	Standby (I_{SB})
L	H	Data Out	Read	Active (I_{CC})
L	L	Data In	Write	Active (I_{CC})

7C195 Truth Table

CE ₁	WE	OE	Data I/O	Mode	Power
H	X	X	High Z	Deselect/Power-Down	Standby (I_{SB})
L	H	L	Data Out	Read	Active (I_{CC})
L	L	X	Data In	Write	Active (I_{CC})
L	H	H	High Z	Deselect	Active (I_{CC})

7C196 Truth Table

CE ₁	CE ₂	WE	OE	Data I/O	Mode	Power
H	X	X	X	High Z	Deselect/Power-Down	Standby (I_{SB})
X	H	X	X			
L	L	H	L	Data Out	Read	Active (I_{CC})
L	L	L	X	Data In	Write	Active (I_{CC})
L	L	H	H	High Z	Deselect	Active (I_{CC})



T-46-23-10

Ordering Information

Speed (ns)	Ordering Code	Package Type	Operating Range
12	CY7C194-12DC	D14	Commercial
	CY7C194-12LC	L54	
	CY7C194-12PC	P13	
	CY7C194-12VC	V13	
15	CY7C194-15DC	D14	Commercial
	CY7C194-15LC	L54	
	CY7C194-15PC	P13	
	CY7C194-15VC	V13	
	CY7C194-15DMB	D14	Military
	CY7C194-15KMB	K73	
	CY7C194-15LMB	L54	
20	CY7C194-20DC	D14	Commercial
	CY7C194-20LC	L54	
	CY7C194-20PC	P13	
	CY7C194-20VC	V13	
	CY7C194-20DMB	D14	Military
	CY7C194-20KMB	K73	
	CY7C194-20LMB	L54	
25	CY7C194-25DC	D14	Commercial
	CY7C194-25LC	L54	
	CY7C194-25PC	P13	
	CY7C194-25VC	V13	
	CY7C194-25DMB	D14	Military
	CY7C194-25KMB	K73	
	CY7C194-25LMB	L54	
35	CY7C194-35DC	D14	Commercial
	CY7C194-35LC	L54	
	CY7C194-35PC	P13	
	CY7C194-35VC	V13	
	CY7C194-35DMB	D14	Military
	CY7C194-35KMB	K73	
45	CY7C194-45DC	D14	Commercial
	CY7C194-45LC	L54	
	CY7C194-45PC	P13	
	CY7C194-45VC	V13	
	CY7C194-45DMB	D14	Military
	CY7C194-45KMB	K73	
	CY7C194-45LMB	L54	

Shaded area contains advanced information.

Speed (ns)	Ordering Code	Package Type	Operating Range
12	CY7C195-12DC	D22	Commercial
	CY7C195-12LC	L54	
	CY7C195-12PC	P21	
	CY7C195-12VC	V21	
15	CY7C195-15DC	D22	Commercial
	CY7C195-15LC	L54	
	CY7C195-15PC	P21	
	CY7C195-15VC	V21	
	CY7C195-15DMB	D22	Military
	CY7C195-15KMB	K74	
	CY7C195-15LMB	L54	
20	CY7C195-20DC	D22	Commercial
	CY7C195-25LC	L54	
	CY7C195-20PC	P21	
	CY7C195-20VC	V21	
	CY7C195-20DMB	D22	Military
	CY7C195-20KMB	K74	
	CY7C195-20LMB	L54	
25	CY7C195-25DC	D22	Commercial
	CY7C195-25LC	L54	
	CY7C195-25PC	P21	
	CY7C195-25VC	V21	
	CY7C195-25DMB	D22	Military
	CY7C195-25KMB	K74	
	CY7C195-25LMB	L54	
35	CY7C195-35DC	D22	Commercial
	CY7C195-35LC	L54	
	CY7C195-35PC	P21	
	CY7C195-35VC	V21	
	CY7C195-35DMB	D22	Military
	CY7C195-35KMB	K74	
45	CY7C195-45DC	D22	Commercial
	CY7C195-45LC	L54	
	CY7C195-45PC	P21	
	CY7C195-45VC	V21	
	CY7C195-45DMB	D22	Military
	CY7C195-45KMB	K74	
	CY7C195-45LMB	L54	

Shaded area contains advanced information.



SRAMS



Ordering Information (continued)

Speed (ns)	Ordering Code	Package Type	Operating Range
12	CY7C196-12DC	D22	Commercial
	CY7C196-12LC	L54	
	CY7C196-12PC	P21	
	CY7C196-12VC	V21	
15	CY7C196-15DC	D22	Commercial
	CY7C196-15LC	L54	
	CY7C196-15PC	P21	
	CY7C196-15VC	V21	
	CY7C196-15DMB	D22	Military
	CY7C196-15KMB	K74	
	CY7C196-15LMB	L54	
20	CY7C196-20DC	D22	Commercial
	CY7C196-20LC	L54	
	CY7C196-20PC	P21	
	CY7C196-20VC	V21	
	CY7C196-20DMB	D22	Military
	CY7C196-20KMB	K74	
	CY7C196-20LMB	L54	
25	CY7C196-25DC	D22	Commercial
	CY7C196-25LC	L54	
	CY7C196-25PC	P21	
	CY7C196-25VC	V21	
	CY7C196-25DMB	D22	Military
	CY7C196-25KMB	K74	
	CY7C196-25LMB	L54	
35	CY7C196-35DC	D22	Commercial
	CY7C196-35LC	L54	
	CY7C196-35PC	P21	
	CY7C196-35VC	V21	
	CY7C196-35DMB	D22	Military
	CY7C196-35KMB	K74	
	CY7C196-35LMB	L54	
45	CY7C196-45DC	D22	Commercial
	CY7C196-45LC	L54	
	CY7C196-45PC	P21	
	CY7C196-45VC	V21	
	CY7C196-45DMB	D22	Military
	CY7C196-45KMB	K74	
	CY7C196-45LMB	L54	

Shaded area contains advanced information.

MILITARY SPECIFICATIONS

Group A Subgroup Testing

DC Characteristics

Parameters	Subgroups
V _{OH}	1, 2, 3
V _{OL}	1, 2, 3
V _{IH}	1, 2, 3
V _{IL} Max.	1, 2, 3
I _{Ix}	1, 2, 3
I _{OZ}	1, 2, 3
I _{OS}	1, 2, 3
I _{CC}	1, 2, 3
I _{SB1}	1, 2, 3
I _{SB2}	1, 2, 3

Switching Characteristics

Parameters	Subgroups
READ CYCLE	
t _{RC}	7, 8, 9, 10, 11
t _{AA}	7, 8, 9, 10, 11
t _{OHA}	7, 8, 9, 10, 11
t _{ACE, ACE2}	7, 8, 9, 10, 11
t _{DOE} ^[16]	7, 8, 9, 10, 11
WRITE CYCLE	
t _{WC}	7, 8, 9, 10, 11
t _{SCE}	7, 8, 9, 10, 11
t _{AW}	7, 8, 9, 10, 11
t _{HA}	7, 8, 9, 10, 11
t _{SA}	7, 8, 9, 10, 11
t _{PWE}	7, 8, 9, 10, 11
t _{SD}	7, 8, 9, 10, 11
t _{HD}	7, 8, 9, 10, 11

Note:
16. 7C195 and 7C196 only.

Document #: 38-00081-F