



MediaClock™ Graphics Clock Generator

Features	Benefits
• Integrated phase-locked loop (PLL)	High-performance PLL tailored for multimedia applications
• Low-jitter, high-accuracy output	Meets critical timing requirements in complex system designs
• 3.3V operation with 2.5V/1.68V output	Enables application compatibility
• Ultra-linear crystal capacitors	Ensures 0PPM Accuracy

Part Number	Outputs	Input Frequency Range	Output Frequencies
CY24141-3	2	18.432 MHz	18.432 MHz, 53.94605395 MHz/54 MHz (selectable)

Logic Block Diagram

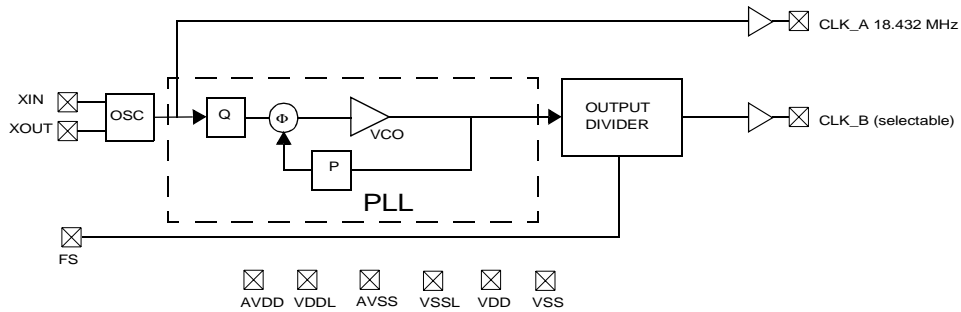

Pin Configurations

CY24141ZC-3
16-pin TSSOP

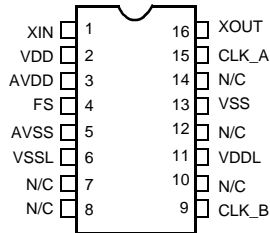

CY24141 Frequency Select Table

Frequency Select	PPM	CLK_B	Unit
1	-1.000073	53.94605395	MHz
0	0	54	MHz

Pin Summary

Pin Name	Pin Number	Pin Description
X _{IN}	1	Reference Input
V _{DD}	2	Voltage Supply
AV _{DD}	3	Analog Voltage Supply
FS	4	Frequency Select Pin (Internal Pull-down Resistor)
AV _{SS}	5	Analog Ground
V _{SSL}	6	Output Ground
N/C	7	No Connect
N/C	8	No Connect
CLK_B	9	53.94605395-MHz/54-MHz Clock Output (Frequency Selectable) @ V _{DDL} level
N/C	10	No Connect
V _{DDL}	11	Output Voltage Supply for CLK_B
N/C	12	No Connect
V _{SS}	13	Ground
N/C	14	No Connect
CLK_A	15	18.432-MHz Clock Output
XOUT ^[1]	16	Reference Output

Absolute Maximum Conditions

Parameter	Description	Min.	Max.	Unit
AVDD	Supply Voltage	-0.5	7.0	V
T _S	Storage Temperature ^[2]	-65	125	°C
T _J	Junction Temperature		125	°C
	Digital Inputs	V _{SS} - 0.3	V _{DD} + 0.3	V
	Digital Outputs referred to V _{DD}	V _{SS} - 0.3	V _{DD} + 0.3	V
	Electrostatic Discharge		2000	V

Recommended Operating Conditions

Parameter	Description	Min.	Typ.	Max.	Unit
AVDD	Analog Voltage Supply	3.15	3.45	3.6	V
VDD	Voltage Supply	3.15	3.45	3.6	V
VDDL _H	2.5V Output Voltage Supply	2.25	2.5	2.75	V
VDDL _L	1.68V Output Voltage Supply	1.63	1.68	1.75	V
T _A	Ambient Temperature	0		85	°C
C _{LOAD}	Max Load Capacitance			15	pF
f _{REF}	Reference Frequency		18.432		MHz

Note:

1. Float X_{OUT} if X_{IN} is externally driven.
2. Rated for 10 years.

DC Electrical Characteristics

Parameter	Description	Conditions	Min.	Typ.	Max.	Unit
$I_{OH3.3}$	Output High Current	$V_{OH} = V_{DD} - 0.5$, $V_{DD} = 3.3$ V	12	24		mA
$I_{OL3.3}$	Output Low Current	$V_{OL} = 0.5$, $V_{DD} = 3.3$ V	12	24		mA
$I_{OH2.5}$	Output High Current	$V_{OH} = V_{DDL} - 0.5$, $V_{DDL} = 2.5$ V	8	20		mA
$I_{OL2.5}$	Output Low Current	$V_{OL} = 0.5$, $V_{DDL} = 2.5$ V	8	20		mA
$I_{OH1.68}$	Output High Current	$V_{OH} = V_{DDL} - 0.5$, $V_{DDL} = 1.68$ V	6	12		mA
$I_{OL1.68}$	Output Low Current	$V_{OL} = 0.5$, $V_{DDL} = 1.68$ V	6	12		mA
V_{IH}	Input High Voltage	FS Frequency Select Input	70%			V_{DD}
V_{IL}	Input Low Voltage	FS Frequency Select Input			30%	V_{DD}
R_I	Input Resistor	FS Frequency Select Pull Down Resistor	80	100	135	kohm
C_{IN}	Input Capacitance				7	pF
X_{LDCAP}	Crystal Load Capacitance	Internal Load Caps		12.9		pF
I_{IZ}	Input Leakage Current			5	10	μ A
I_{DD}	Supply Current	Sum of Core and Output Current		30	35	mA

Cycle-Cycle Jitter Specifications ($V_{DD} = 3.15V-3.6V$)

Parameter	Description	Conditions	1σ	Typ.	Max.	Unit
t_9	Clock Jitter–peak-peak	Cycle-Cycle Jitter–18.432 MHz	12	55	140	ps
t_9	Clock Jitter–peak-peak	Cycle-Cycle Jitter–54 MHz $V_{DDL} = 1.63V-1.75V$	32	135	220	ps
t_9	Clock Jitter–peak-peak	Cycle-Cycle Jitter–54 MHz $V_{DDL} = 2.25V-2.75V$	11	70	150	ps
t_9	Clock Jitter–peak-peak	Cycle-Cycle Jitter–53.94605395 MHz $V_{DDL} = 1.63V-1.75V$	31	160	220	ps
t_9	Clock Jitter–peak-peak	Cycle-Cycle Jitter–53.94605395 MHz $V_{DDL} = 2.25V-2.75V$	11	70	150	ps

1000-cycle Jitter ($V_{DD} = 3.15V-3.6V$)

Parameter	Description	Conditions	1σ	Typ.	Max.	Unit
t_{10}	Clock Jitter–peak-peak	1000-Cycle-Cycle Jitter–18.432 MHz	19	95	140	ps
t_{10}	Clock Jitter–peak-peak	1000-Cycle-Cycle Jitter–54 MHz $V_{DDL} = 1.63V-1.75V$	55	275	400	ps
t_{10}	Clock Jitter–peak-peak	1000-Cycle-Cycle Jitter–54 MHz $V_{DDL} = 2.25V-2.75V$	50	275	400	ps
t_{10}	Clock Jitter–peak-peak	1000-Cycle-Cycle Jitter–53.94605395 MHz– $V_{DDL} = 1.63V-1.75V$	293	1025	1200	ps
t_{10}	Clock Jitter–peak-peak	1000-Cycle-Cycle Jitter–53.94605395 MHz– $V_{DDL} = 2.25V-2.75V$	290	1025	1200	ps

Phase Noise Specifications

Parameter	Description	Conditions	Min.	Typ.	Max.	Unit
	Phase Noise	18.432 MHz @ 10-kHz offset		–119		dBc
	Phase Noise	54 MHz @ 10-kHz offset		–95		dBc
	Phase Noise	53.94605395 MHz @ 10-kHz offset		–92		dBc

AC Electrical Characteristics ($V_{DD} = 3.15V-3.6V$)

Parameter ^[3]	Description	Conditions	Min.	Typ.	Max.	Unit
F_{ppm}	Frequency Error	Part to Part (three lots tested on same board, PCB board can vary more than ± 5 ppm)		± 5	± 10	ppm
F_{ppm}	Frequency Error	Over temperature from 0 to 85°C (crystal should not be heated for this test, only IC)		± 2	± 5	ppm

Note:

3. Not 100% tested.

AC Electrical Characteristics ($V_{DD} = 3.15V-3.6V$) (continued)

Parameter ^[3]	Description	Conditions	Min.	Typ.	Max.	Unit
DC	Output Duty Cycle	Duty Cycle is defined in Figure 1, 50% of V_{DD}	45	50	55	%
t_3	Rising Edge Slew Rate	Output Clock Rise Time, 20%–80% of $V_{DD}/V_{DDL} = 2.5V$	0.8	1.4		V/ns
t_4	Falling Edge Slew Rate	Output Clock Fall Time, 80%–20% of $V_{DD}/V_{DDL} = 2.5V$	0.8	1.4		V/ns
t_5	PLL Lock Time				3	ms

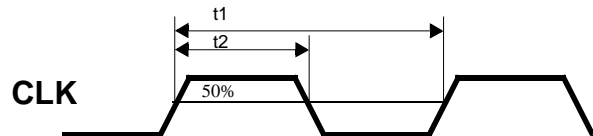
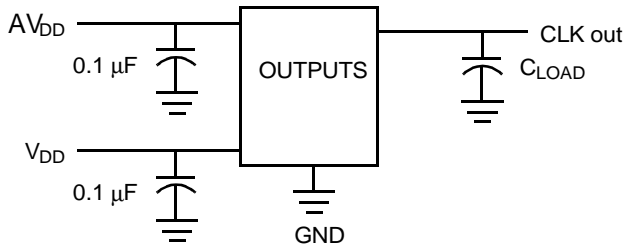
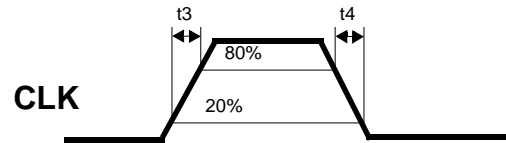
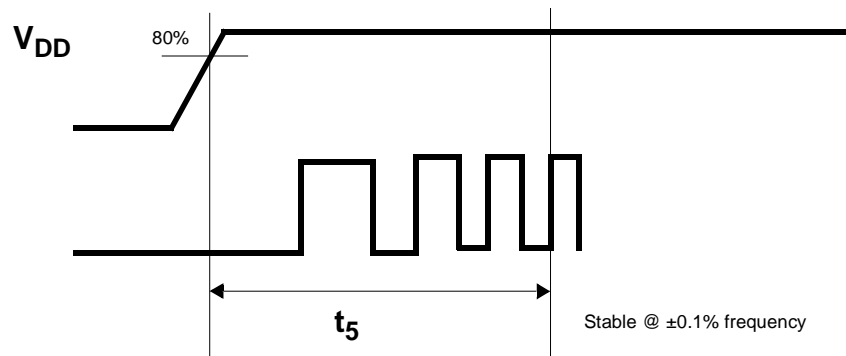
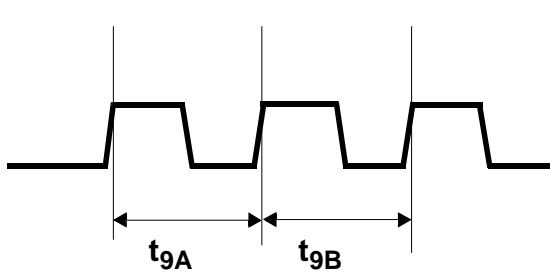
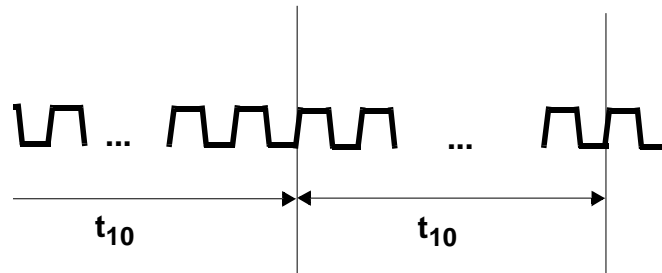
Test Circuit

Figure 1. Duty Cycle Definition; $DC = t_2/t_1$

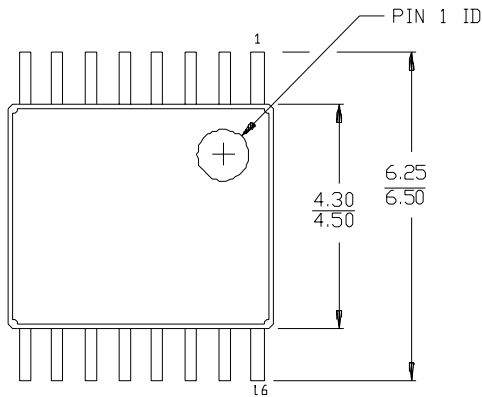
Figure 2. Rise and Fall Time Definitions

Figure 3. PLL Lock Time

Figure 4. Cycle-Cycle Jitter

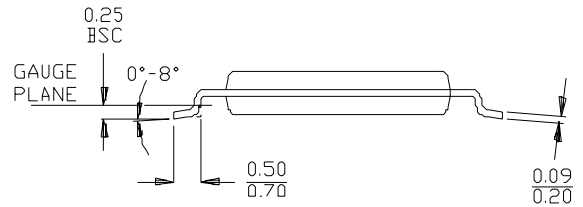
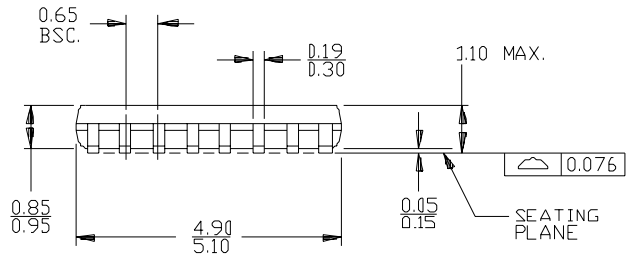
Figure 5. 1000-Cycle Jitter
Ordering Information

Ordering Code	Package Name	Package Type	Operating Range	Operating Voltage
CY24141ZC-3	Z16	16-TSSOP	Commercial	3.3V

16-lead Thin Shrunk Small Outline Package (4.40-MM Body) Z16

DIMENSIONS IN MILLIMETERS.

MIN.
MAX.



51-85091

MediaClock is a trademark of Cypress Semiconductor. All products and company names mentioned in this document are the trademarks of their respective holders.



Document Title: CY24141-3 MediaClock™ Graphics Clock Generator Document Number: 38-07324				
REV.	ECN NO.	Issue Date	Orig. of Change	Description of Change
**	111593	04/30/02	CKN	New Data Sheet