



FAN5400/FAN5401/FAN5402/FAN5403/FAN5404/FAN5405 USB-Compliant Single-Cell Li-Ion Switching Charger with USB-OTG Boost Regulator

Features

- Fully Integrated, High-Efficiency Charger for Single-Cell Li-Ion and Li-Polymer Battery Packs
- Faster Charging than Linear
- Charge Voltage Accuracy: $\pm 0.5\%$ at 25°C
 $\pm 1\%$ from 0 to 125°C
- $\pm 5\%$ Input Current Regulation Accuracy
- $\pm 5\%$ Charge Current Regulation Accuracy
- 20 V Absolute Maximum Input Voltage
- 6 V Maximum Input Operating Voltage
- 1.25 A Maximum Charge Rate
- Programmable through High-Speed I²C Interface (3.4 Mb/s) with Fast Mode Plus Compatibility
 - Input Current
 - Fast-Charge / Termination Current
 - Charger Voltage
 - Termination Enable
- 3 MHz Synchronous Buck PWM Controller with Wide Duty Cycle Range
- Small Footprint 1 μH External Inductor
- Safety Timer with Reset Control
- 1.8 V Regulated Output from VBUS for Auxiliary Circuits
- Weak Input Sources Accommodated by Reducing Charging Current to Maintain Minimum VBUS Voltage
- Low Reverse Leakage to Prevent Battery Drain to VBUS
- 5 V, 300 mA Boost Mode for USB OTG for 2.5 to 4.5 V Battery Input

Applications

- Cell Phones, Smart Phones, PDAs
- Tablet, Portable Media Players
- Gaming Device, Digital Cameras

All trademarks are the property of their respective owners.

Description

The FAN5400 family (FAN540x) combines a highly integrated switch-mode charger, to minimize single-cell Lithium-ion (Li-ion) charging time from a USB power source, and a boost regulator to power a USB peripheral from the battery.

The charging parameters and operating modes are programmable through an I²C Interface that operates up to 3.4 Mbps. The charger and boost regulator circuits switch at 3 MHz to minimize the size of external passive components.

The FAN540X provides battery charging in three phases: conditioning, constant current, and constant voltage.

To ensure USB compliance and minimize charging time, the input current is limited to the value set through the I²C host. Charge termination is determined by a programmable minimum current level. A safety timer with reset control provides a safety backup for the I²C host.

The integrated circuit (IC) automatically restarts the charge cycle when the battery falls below an internal threshold. If the input source is removed, the IC enters a high-impedance mode with leakage from the battery to the input prevented. Charge status is reported back to the host through the I²C port. Charge current is reduced when the die temperature reaches 120°C .

The FAN540X can operate as a boost regulator on command from the system. The boost regulator includes a soft-start that limits inrush current from the battery.

The FAN540X is available in a 1.96 x 1.87 mm, 20-bump, 0.4 mm pitch, WLCSP package.

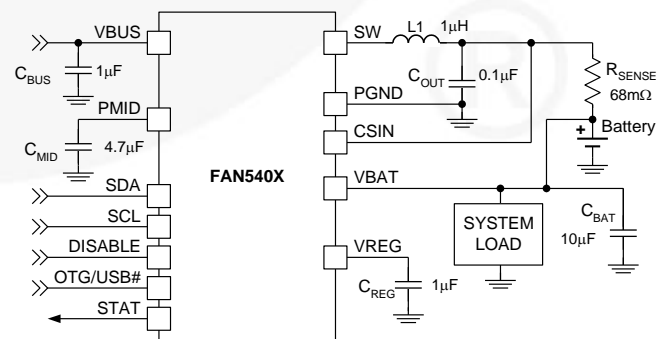

Figure 1. Typical Application (FAN5403-05 Pin Out)

Ordering Information

Part Number	Temperature Range	Package	PN Bits: IC_INFO[4:3]	Packing Method
FAN5400UCX	-40 to 85°C	20-Bump, Wafer-Level Chip-Scale Package (WLCSP), 0.4 mm Pitch, Estimated Size: 1.96 x 1.87 mm	01	Tape and Reel
FAN5401UCX	-40 to 85°C		00	Tape and Reel
FAN5402UCX	-40 to 85°C		01	Tape and Reel
FAN5403UCX	-40 to 85°C		10	Tape and Reel
FAN5403BUCX ⁽¹⁾	-40 to 85°C		10	Tape and Reel
FAN5404UCX	-40 to 85°C		11	Tape and Reel
FAN5405UCX	-40 to 85°C		10	Tape and Reel
FAN5405BUCX ⁽¹⁾	-40 to 85°C		10	Tape and Reel

Note:

1. FAN5403BUCX and FAN5405BUCX Includes backside lamination

Table 1. Feature Comparison Summary

Part Number	PN Bits: REG3[4:3]	Slave Address	Automatic Charge	Special Charger ⁽²⁾	Safety Limits	Battery Absent Behavior	E2 Pin	VREG (E3 Pin)
FAN5400	01	1101011	Yes	No	No	OFF	AUXPWR (Connect to VBAT)	PMID
FAN5401	00	1101011	No	No	No	OFF		
FAN5402	01	1101011	Yes	No	No	ON		
FAN5403	10	1101011	Yes	Yes	Yes	OFF	DISABLE	1.8V
FAN5404	11	1101011	No	Yes	Yes	OFF		
FAN5405	10	1101010	Yes	Yes	Yes	ON		

Note:

2. Special charger is a current limited charger that is not a USB compliant source.

Table 2. Recommended External Components

Component	Description	Vendor	Parameter	Typ.	Unit
L1	1 μ H, 20%, 1.3 A, 2016	Murata: LQM2MPN1R0M or Equivalent	L	1.0	μ H
			DCR (Series R)	85	m Ω
C _{BAT}	10 μ F, 20%, 6.3 V, X5R, 0603	Murata: GRM188R60J106M TDK: C1608X5R0J106M	C	10	μ F
C _{MID}	4.7 μ F, 10%, 6.3 V, X5R, 0603	Murata: GRM188R60J475K TDK: C1608X5R0J475K	C ⁽³⁾	4.7	μ F
C _{BUS}	1.0 μ F, 10%, 25 V, X5R, 0603	Murata GRM188R61E105K TDK:C1608X5R1E105M	C	1.0	μ F

Note:

3. 6.3 V rating is sufficient for C_{MID} since PMID is protected from over-voltage surges on VBUS by Q3 (Figure 3).

Block Diagram

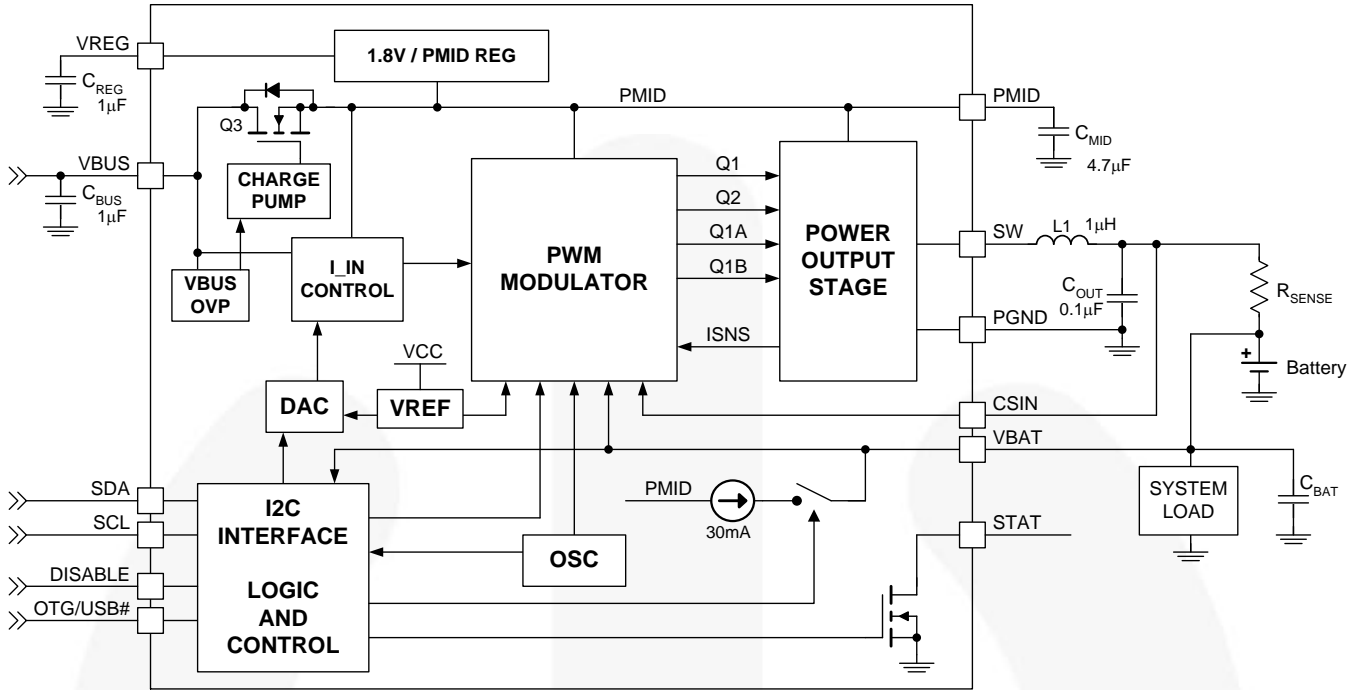

Figure 2. IC and System Block Diagram

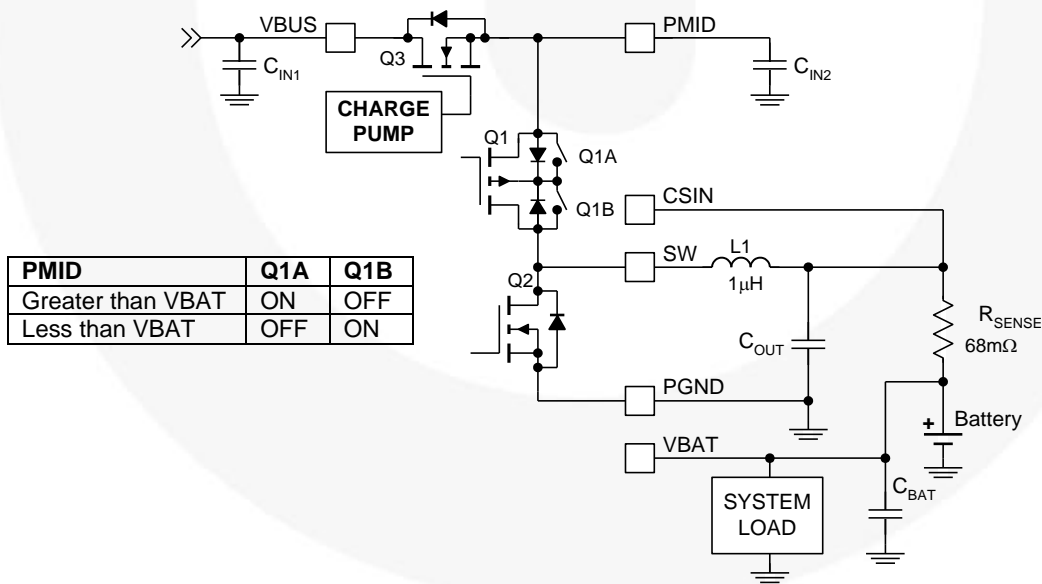

Figure 3. Power Stage

Pin Configuration



Figure 4. WLCSP-20 Pin Assignments

Pin Definitions

Pin #	Name	Part #	Description
A1, A2	VBUS	ALL	Charger Input Voltage and USB-OTG output voltage. Bypass with a 1 μ F capacitor to PGND.
A3	NC	ALL	No Connect. No external connection is made between this pin and the IC's internal circuitry.
A4	SCL	ALL	I²C Interface Serial Clock. This pin should not be left floating.
B1-B3	PMID	ALL	Power Input Voltage. Power input to the charger regulator, bypass point for the input current sense, and high-voltage input switch. Bypass with a minimum of 4.7 μ F, 6.3 V capacitor to PGND.
B4	SDA	ALL	I²C Interface Serial Data. This pin should not be left floating.
C1-C3	SW	ALL	Switching Node. Connect to output inductor.
C4	STAT	ALL	Status. Open-drain output indicating charge status. The IC pulls this pin LOW when charge is in process.
D1-D3	PGND	ALL	Power Ground. Power return for gate drive and power transistors. The connection from this pin to the bottom of C _{MID} should be as short as possible.
D4	OTG	ALL	On-The-Go. Enables boost regulator in conjunction with OTG_EN and OTG_PL bits (see Table 16). On VBUS Power-On Reset (POR), this pin sets the input current limit for t _{15MIN} charging.
E1	CSIN	ALL	Current-Sense Input. Connect to the sense resistor in series with the battery. The IC uses this node to sense current into the battery. Bypass this pin with a 0.1 μ F capacitor to PGND.
E2	AUXPWR	FAN5400, FAN5401, FAN5402	Auxiliary Power. Connect to the battery pack to provide IC power during High-Impedance Mode. Bypass with a 1 μ F capacitor to PGND.
E2	DISABLE	FAN5403, FAN5404, FAN5405	Charge Disable. If this pin is HIGH, charging is disabled. When LOW, charging is controlled by the I ² C registers. When this pin is HIGH, the 15-minute timer is reset. This pin does not affect the 32-second timer.
E3	VREG	ALL	Regulator Output. Connect to a 1 μ F capacitor to PGND. This pin can supply up to 2 mA of DC load current. For FAN5400-FAN5402, the output voltage is PMID, which is limited to 6.5 V. For FAN5403-FAN5405, the output voltage is regulated to 1.8 V.
E4	VBAT	ALL	Battery Voltage. Connect to the positive (+) terminal of the battery pack. Bypass with a 0.1 μ F capacitor to PGND if the battery is connected through long leads.

Absolute Maximum Ratings

Stresses exceeding the absolute maximum ratings may damage the device. The device may not function or be operable above the recommended operating conditions and stressing the parts to these levels is not recommended. In addition, extended exposure to stresses above the recommended operating conditions may affect device reliability. The absolute maximum ratings are stress ratings only.

Symbol	Parameter		Min.	Max.	Unit
V _{BUS}	VBUS Voltage	Continuous	-1.4	20.0	V
		Pulsed, 100 ms Maximum Non-Repetitive	-2.0		
V _{STAT}	STAT Voltage		-0.3	16.0	V
V _I	PMID Voltage			7.0	V
	SW, CSIN, VBAT, AUXPWR, DISABLE Voltage		-0.3	7.0	
V _O	Voltage on Other Pins		-0.3	6.5 ⁽⁴⁾	V
$\frac{dV_{BUS}}{dt}$	Maximum VBUS Slope above 5.5 V when Boost or Charger are Active			4	V/ μ s
ESD	Electrostatic Discharge Protection Level	Human Body Model per JESD22-A114	2000		V
		Charged Device Model per JESD22-C101	500		
T _J	Junction Temperature		-40	+150	°C
T _{STG}	Storage Temperature		-65	+150	°C
T _L	Lead Soldering Temperature, 10 Seconds			+260	°C

Note:

4. Lesser of 6.5 V or V_I + 0.3 V.

Recommended Operating Conditions

The Recommended Operating Conditions table defines the conditions for actual device operation. Recommended operating conditions are specified to ensure optimal performance to the datasheet specifications. Fairchild does not recommend exceeding them or designing to absolute maximum ratings.

Symbol	Parameter		Min.	Max.	Units
V _{BUS}	Supply Voltage		4	6	V
V _{BAT(MAX)}	Maximum Battery Voltage when Boost enabled			4.5	V
$\frac{dV_{BUS}}{dt}$	Negative VBUS Slew Rate during VBUS Short Circuit, C _{MID} ≤ 4.7 μ F, see <i>VBUS Short While Charging</i>	T _A ≤ 60°C		4	V/ μ s
		T _A ≥ 60°C		2	
T _A	Ambient Temperature		-30	+85	°C
T _J	Junction Temperature (<i>see Thermal Regulation and Protection section</i>)		-30	+120	°C

Thermal Properties

Junction-to-ambient thermal resistance is a function of application and board layout. This data is measured with four-layer 2s2p boards in accordance with JEDEC standard JESD51. Special attention must be paid not to exceed junction temperature T_{J(max)} at a given ambient temperature T_A. For measured data, see Table 11.

Symbol	Parameter	Typical	Units
θ_{JA}	Junction-to-Ambient Thermal Resistance	60	°C/W
θ_{JB}	Junction-to-PCB Thermal Resistance	20	°C/W

Electrical Specifications

Unless otherwise specified: according to the circuit of Figure 1; recommended operating temperature range for T_J and T_A ; $V_{BUS}=5.0$ V; HZ_MODE ; $OPA_MODE=0$; (Charge Mode); SCL , SDA , $OTG=0$ or 1.8 V; and typical values are for $T_J=25^\circ\text{C}$.

Symbol	Parameter	Conditions	Min.	Typ.	Max.	Units	
Power Supplies							
I_{VBUS}	VBUS Current	$V_{BUS} > V_{BUS(min)}$, PWM Switching		10		mA	
		$V_{BUS} > V_{BUS(min)}$; PWM Enabled, Not Switching (Battery OVP Condition); I_{IN} Setting=100 mA		2.5		mA	
		$0^\circ\text{C} < T_J < 85^\circ\text{C}$, $HZ_MODE=1$ $V_{BAT} < V_{LOWV}$, 32S Mode		63	90	μA	
I_{LKG}	VBAT to VBUS Leakage Current	$0^\circ\text{C} < T_J < 85^\circ\text{C}$, $HZ_MODE=1$, $V_{BAT}=4.2$ V, $V_{BUS}=0$ V		0.2	5.0	μA	
I_{BAT}	Battery Discharge Current in High-Impedance Mode	$0^\circ\text{C} < T_J < 85^\circ\text{C}$, $HZ_MODE=1$, $V_{BAT}=4.2$ V			20	μA	
		FAN5403-05, $DISABLE=1$, $0^\circ\text{C} < T_J < 85^\circ\text{C}$, $V_{BAT}=4.2$ V			10		
Charger Voltage Regulation							
V_{OREG}	Charge Voltage Range		3.5		4.4	V	
	Charge Voltage Accuracy	$T_A=25^\circ\text{C}$	-0.5%		+0.5%		
		$T_J=0$ to 125°C	-1%		+1%		
Charging Current Regulation							
I_{OCHRG}	Output Charge Current Range	$V_{LOWV} < V_{BAT} < V_{OREG}$ $V_{BUS} > V_{SLP}$, $R_{SENSE}=68$ m Ω		550		1250	mA
	Charge Current Accuracy Across R_{SENSE}	20 mV $\leq V_{IREG} \leq$ 40 mV	FAN5400-02	95	100	105	%
			FAN5403-05	92	97	102	
		$V_{IREG} > 40$ mV	FAN5400-02	97	100	103	
			FAN5403-05	94	97	100	
Weak Battery Detection							
V_{LOWV}	Weak Battery Threshold Range		3.4		3.7	V	
	Weak Battery Threshold Accuracy		-5		+5	%	
	Weak Battery Deglitch Time	Rising Voltage, 2 mV Overdrive		30		ms	
Logic Levels: DISABLE, SDA, SCL, OTG							
V_{IH}	High-Level Input Voltage		1.05			V	
V_{IL}	Low-Level Input Voltage				0.4	V	
I_{IN}	Input Bias Current	Input Tied to GND or V_{IN}		0.01	1.00	μA	
Charge Termination Detection							
$I_{(TERM)}$	Termination Current Range	$V_{BAT} > V_{OREG} - V_{RCH}$, $V_{BUS} > V_{SLP}$, $R_{SENSE}=68$ m Ω		50		400	mA
	Termination Current Accuracy	$[V_{CSIN} - V_{BAT}]$ from 3 mV to 20 mV	-25		+25	%	
		$[V_{CSIN} - V_{BAT}]$ from 20 mV to 40 mV	-5		+5		
Termination Current Deglitch Time	2 mV Overdrive			30		ms	
1.8 V Linear Regulator							
V_{REG}	1.8 V Regulator Output	I_{REG} from 0 to 2 mA, FAN5403-05	1.7	1.8	1.9	V	

Continued on the following page...

Electrical Specifications

Unless otherwise specified: according to the circuit of Figure 1; recommended operating temperature range for T_J and T_A ; $V_{BUS}=5.0$ V; HZ_MODE ; $OPA_MODE=0$; (Charge Mode); SCL , SDA , $OTG=0$ or 1.8 V; and typical values are for $T_J=25^\circ\text{C}$.

Symbol	Parameter	Conditions	Min.	Typ.	Max.	Units
Input Power Source Detection						
$V_{IN(MIN)1}$	VBUS Input Voltage Rising	To Initiate and Pass VBUS Validation		4.29	4.42	V
$V_{IN(MIN)2}$	Minimum VBUS during Charge	During Charging		3.71	3.94	V
t_{VBUS_VALID}	VBUS Validation Time			30		ms
Special Charger (V_{BUS}) (FAN5403 – FAN5405)						
V_{SP}	Special Charger Setpoint Accuracy		-3		+3	%
Input Current Limit						
I_{INLIM}	Input Current Limit Threshold	I_{IN} Set to 100 mA	88	93	98	mA
		I_{IN} Set to 500 mA	450	475	500	
V_{REF} Bias Generator						
V_{REF}	Bias Regulator Voltage	$V_{BUS} > V_{IN(MIN)}$ or $V_{BAT} > V_{BAT(MIN)}$			6.5	V
	Short-Circuit Current Limit			20		mA
Battery Recharge Threshold						
V_{RCH}	Recharge Threshold	Below $V_{(OREG)}$	100	120	150	mV
	Deglintch Time	V_{BAT} Falling Below V_{RCH} Threshold		130		ms
STAT Output						
$V_{STAT(OL)}$	STAT Output Low	$I_{STAT}=10$ mA			0.4	V
$I_{STAT(OH)}$	STAT High Leakage Current	$V_{STAT}=5$ V			1	μA
Battery Detection						
I_{DETECT}	Battery Detection Current before Charge Done (Sink Current) ⁽⁵⁾	Begins after Termination Detected and $V_{BAT} \leq V_{OREG} - V_{RCH}$		-0.80		mA
t_{DETECT}	Battery Detection Time			262		ms
Sleep Comparator						
V_{SLP}	Sleep-Mode Entry Threshold, $V_{BUS} - V_{BAT}$	$2.3 \text{ V} \leq V_{BAT} \leq V_{OREG}$, V_{BUS} Falling	0	0.04	0.10	V
V_{SLP_EXIT}	Deglintch Time for VBUS Rising Above $V_{SLP} + V_{SLP_EXIT}$	Rising Voltage		30		ms
Power Switches (see Figure 3)						
$R_{DS(ON)}$	Q3 On Resistance (VBUS to PMID)	$I_{IN(LIMIT)}=500$ mA		180	250	m Ω
	Q1 On Resistance (PMID to SW)			130	225	
	Q2 On Resistance (SW to GND)			150	225	
Charger PWM Modulator						
f_{SW}	Oscillator Frequency		2.7	3.0	3.3	MHz
D_{MAX}	Maximum Duty Cycle				100	%
D_{MIN}	Minimum Duty Cycle			0		%
I_{SYNC}	Synchronous to Non-Synchronous Current Cut-Off Threshold ⁽⁶⁾	Low-Side MOSFET (Q2) Cycle-by-Cycle Current Limit		140		mA

Continued on the following page...

Electrical Specifications

Unless otherwise specified: according to the circuit of Figure 1; recommended operating temperature range for T_J and T_A ; $V_{BUS}=5.0$ V; HZ_MODE ; $OPA_MODE=0$; (Charge Mode); SCL , SDA , $OTG=0$ or 1.8 V; and typical values are for $T_J=25^\circ\text{C}$.

Symbol	Parameter	Conditions	Min.	Typ.	Max.	Units
Boost Mode Operation ($OPA_MODE=1$, $HZ_MODE=0$)						
V_{BOOST}	Boost Output Voltage at V_{BUS}	$2.5\text{ V} < V_{BAT} < 4.5\text{ V}$, I_{LOAD} from 0 to 200 mA	4.80	5.07	5.17	V
		$2.7\text{ V} < V_{BAT} < 4.5\text{ V}$, I_{LOAD} from 0 to 200 mA	4.85	5.07	5.17	
$I_{BAT(BOOST)}$	Boost Mode Quiescent Current	PFM Mode, $V_{BAT}=3.6\text{ V}$, $I_{OUT}=0$		140	300	μA
$I_{LIMPK(BST)}$	Q2 Peak Current Limit		1100	1380	1660	mA
$UVLO_{BST}$	Minimum Battery Voltage for Boost Operation	While Boost Active		2.42		V
		To Start Boost Regulator		2.58	2.70	
VBUS Load Resistance						
R_{VBUS}	VBUS to PGND Resistance	Normal Operation		1500		$\text{K}\Omega$
		Charger Validation		100		Ω
Protection and Timers						
$V_{BUS_{OVP}}$	VBUS Over-Voltage Shutdown	V_{BUS} Rising	6.09	6.29	6.49	V
	Hysteresis	V_{BUS} Falling		100		mV
$I_{LIMPK(CHG)}$	Q1 Cycle-by-Cycle Peak Current Limit	Charge Mode		2.3		A
V_{SHORT}	Battery Short-Circuit Threshold	V_{BAT} Rising	1.95	2.00	2.05	V
	Hysteresis	V_{BAT} Falling		100		
I_{SHORT}	Linear Charging Current	$V_{BAT} < V_{SHORT}$	20	30	40	mA
$T_{SHUTDWN}$	Thermal Shutdown Threshold ⁽⁷⁾	T_J Rising		145		$^\circ\text{C}$
	Hysteresis ⁽⁷⁾	T_J Falling		10		
T_{CF}	Thermal Regulation Threshold ⁽⁷⁾	Charge Current Reduction Begins		120		$^\circ\text{C}$
t_{INT}	Detection Interval			2.1		s
t_{32S}	32-Second Timer ⁽⁸⁾	Charger Enabled	20.5	25.2	28.0	s
		Charger Disabled	18.0	25.2	34.0	
t_{15MIN}	15-Minute Timer	15-Minute Mode (FAN5400, FAN5402, FAN5404, FAN5405)	12.0	13.5	15.0	min
Δt_{LF}	Low-Frequency Timer Accuracy	Charger Inactive	-25		25	%

Notes:

- Negative current is current flowing from the battery to V_{BUS} (discharging the battery).
- Q2 always turns on for 60 ns, then turns off if current is below I_{SYNC} .
- Guaranteed by design; not tested in production.
- This tolerance (%) applies to all timers on the IC, including soft-start and deglitching timers.

I²C Timing Specifications

Guaranteed by design.

Symbol	Parameter	Conditions	Min.	Typ.	Max.	Units
f _{SCL}	SCL Clock Frequency	Standard Mode			100	kHz
		Fast Mode			400	
		High-Speed Mode, C _B ≤ 100 pF			3400	
		High-Speed Mode, C _B ≤ 400 pF			1700	
t _{BUF}	Bus-Free Time between STOP and START Conditions	Standard Mode		4.7		μs
		Fast Mode		1.3		
t _{HD;STA}	START or Repeated START Hold Time	Standard Mode		4		μs
		Fast Mode		600		ns
		High-Speed Mode		160		ns
t _{LOW}	SCL LOW Period	Standard Mode		4.7		μs
		Fast Mode		1.3		μs
		High-Speed Mode, C _B ≤ 100 pF		160		ns
		High-Speed Mode, C _B ≤ 400 pF		320		ns
t _{HIGH}	SCL HIGH Period	Standard Mode		4		μs
		Fast Mode		600		ns
		High-Speed Mode, C _B ≤ 100 pF		60		ns
		High-Speed Mode, C _B ≤ 400 pF		120		ns
t _{SU;STA}	Repeated START Setup Time	Standard Mode		4.7		μs
		Fast Mode		600		ns
		High-Speed Mode		160		ns
t _{SU;DAT}	Data Setup Time	Standard Mode		250		ns
		Fast Mode		100		
		High-Speed Mode		10		
t _{HD;DAT}	Data Hold Time	Standard Mode	0		3.45	μs
		Fast Mode	0		900	ns
		High-Speed Mode, C _B ≤ 100 pF	0		70	ns
		High-Speed Mode, C _B ≤ 400 pF	0		150	ns
t _{RCL}	SCL Rise Time	Standard Mode	20 + 0.1C _B		1000	ns
		Fast Mode	20 + 0.1C _B		300	
		High-Speed Mode, C _B ≤ 100 pF		10	80	
		High-Speed Mode, C _B ≤ 400 pF		20	160	
t _{FCL}	SCL Fall Time	Standard Mode	20 + 0.1C _B		300	ns
		Fast Mode	20 + 0.1C _B		300	
		High-Speed Mode, C _B ≤ 100 pF		10	40	
		High-Speed Mode, C _B ≤ 400 pF		20	80	
t _{RDA} t _{RCL1}	SDA Rise Time Rise Time of SCL after a Repeated START Condition and after ACK Bit	Standard Mode	20 + 0.1C _B		1000	ns
		Fast Mode	20 + 0.1C _B		300	
		High-Speed Mode, C _B ≤ 100 pF		10	80	
		High-Speed Mode, C _B ≤ 400 pF		20	160	

Continued on the following page...

I²C Timing Specifications

Guaranteed by design.

Symbol	Parameter	Conditions	Min.	Typ.	Max.	Units
t _{FDA}	SDA Fall Time	Standard Mode		20 + 0.1C _B	300	ns
		Fast Mode		20 + 0.1C _B	300	
		High-Speed Mode, C _B ≤ 100 pF		10	80	
		High-Speed Mode, C _B ≤ 400 pF		20	160	
t _{SU;STO}	Stop Condition Setup Time	Standard Mode		4		μs
		Fast Mode		600		ns
		High-Speed Mode		160		ns
C _B	Capacitive Load for SDA, SCL				400	pF

Timing Diagrams

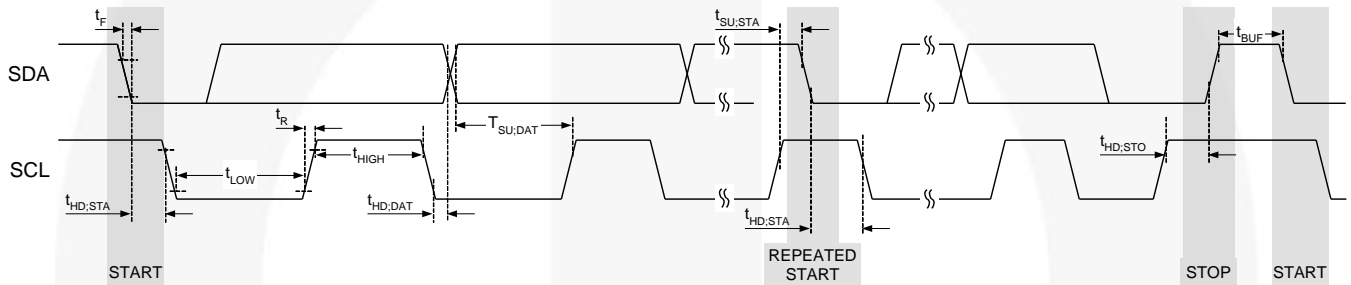
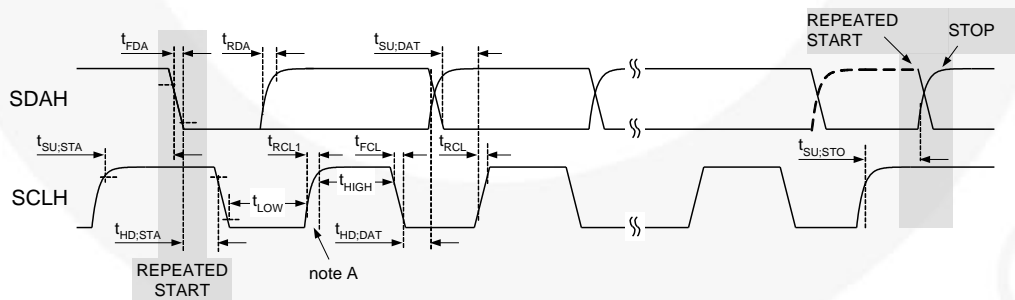

Figure 5. I²C Interface Timing for Fast and Slow Modes



= MCS Current Source Pull-up

= R_p Resistor Pull-up

Note A: First rising edge of SCLH after Repeated Start and after each ACK bit.

Figure 6. I²C Interface Timing for High-Speed Mode

Charge Mode Typical Characteristics

Unless otherwise specified, circuit of Figure 1, $V_{OREG}=4.2\text{ V}$, $V_{BUS}=5.0\text{ V}$, and $T_A=25^\circ\text{C}$.

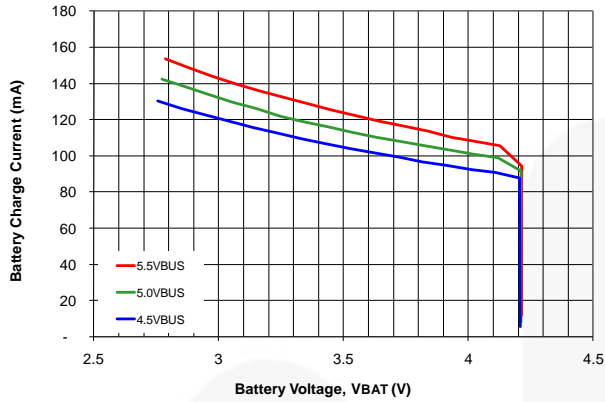

Figure 7. Battery Charge Current vs. V_{BUS} with $I_{INLIM}=100\text{ mA}$

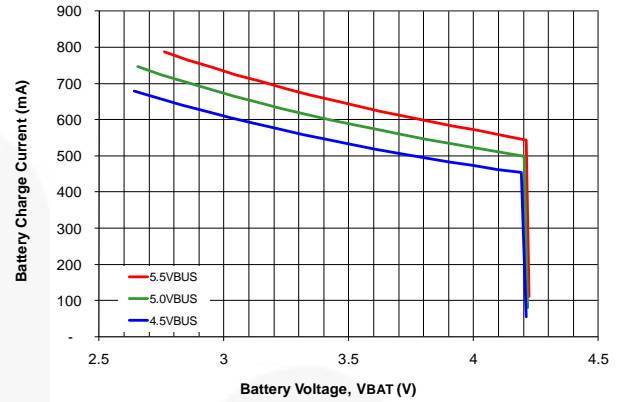

Figure 8. Battery Charge Current vs. V_{BUS} with $I_{INLIM}=500\text{ mA}$

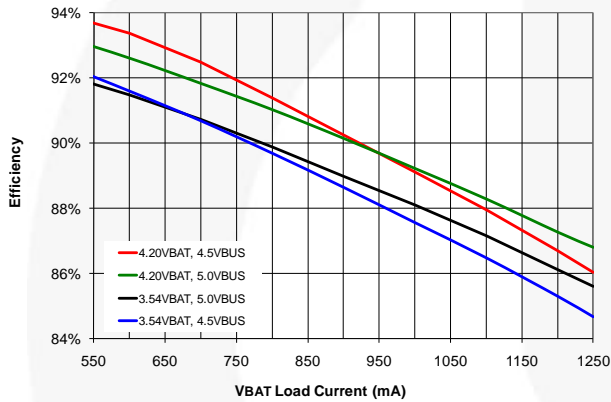

Figure 9. Charger Efficiency, No I_{INLIM} , $I_{CHARGE}=1,250\text{ mA}$

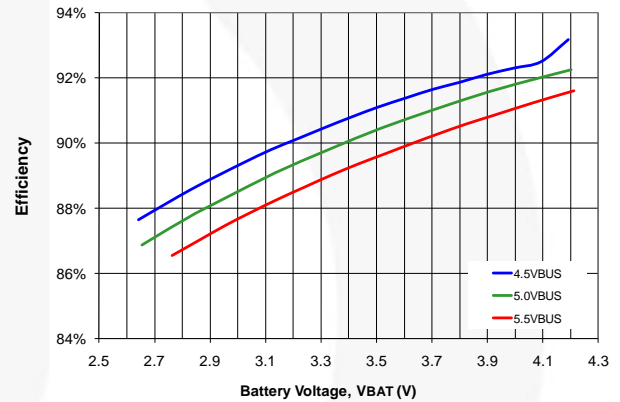

Figure 10. Charger Efficiency vs. V_{BUS} , $I_{INLIM}=500\text{ mA}$

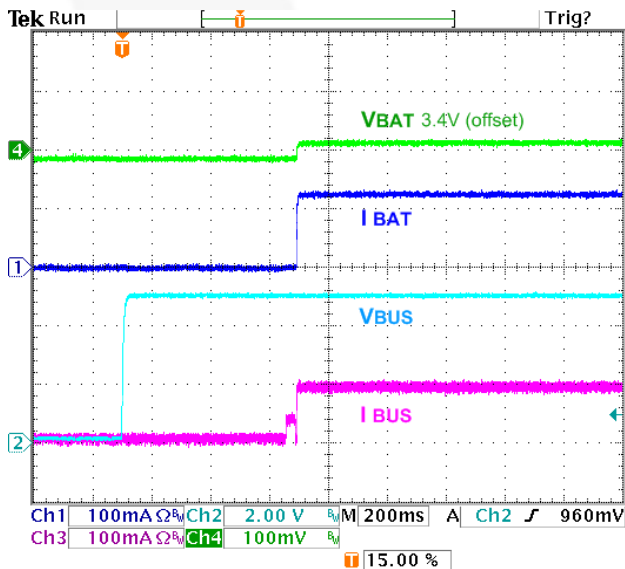

Figure 11. Auto-Charge Startup at V_{BUS} Plug-in, $I_{INLIM}=100\text{ mA}$, $OTG=1$, $V_{BAT}=3.4\text{ V}$

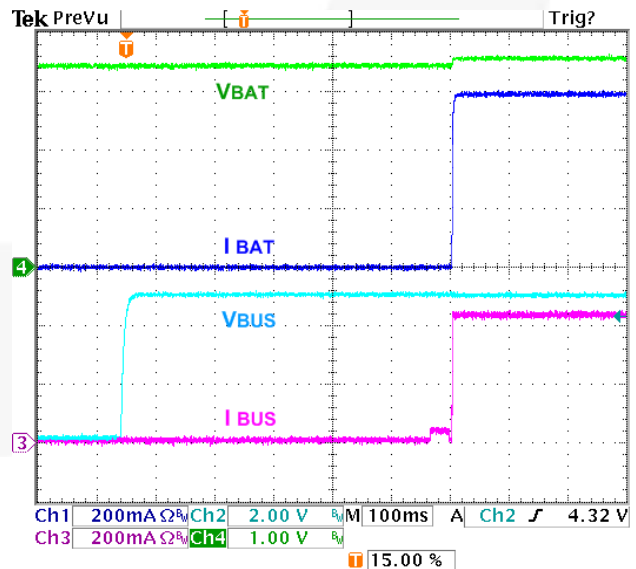

Figure 12. Auto-Charge Startup at V_{BUS} Plug-in, $I_{INLIM}=500\text{ mA}$, $OTG=1$, $V_{BAT}=3.4\text{ V}$

Charge Mode Typical Characteristics

Unless otherwise specified, circuit of Figure 1, $V_{OREG}=4.2\text{ V}$, $V_{BUS}=5.0\text{ V}$, and $T_A=25^\circ\text{C}$.

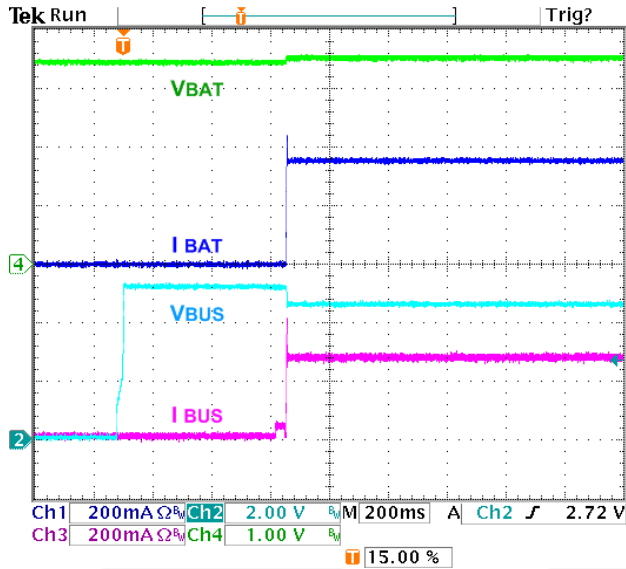

Figure 13. AutoCharge Startup with 300 mA Limited Charger / Adaptor, $I_{NLIM}=500\text{ mA}$, $OTG=1$, $V_{BAT}=3.4\text{ V}$

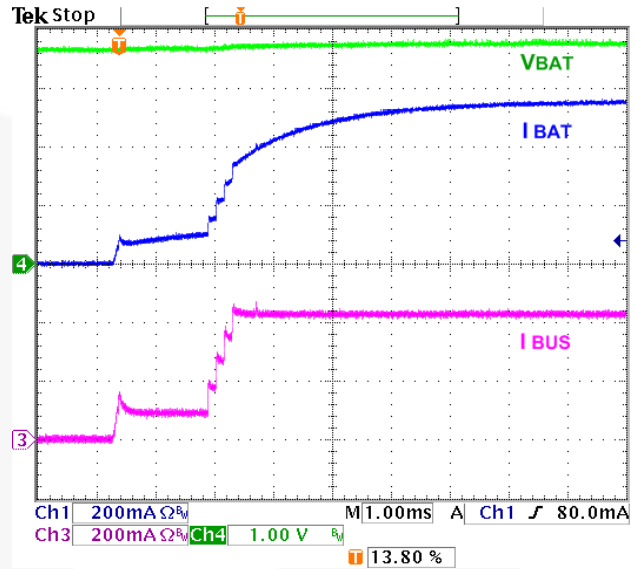

Figure 14. Charger Startup with HZ_MODE Bit Reset, $I_{NLIM}=500\text{ mA}$, $I_{OCHARGE}=950\text{ mA}$, $OREG=4.2\text{ V}$, $V_{BAT}=3.6\text{ V}$

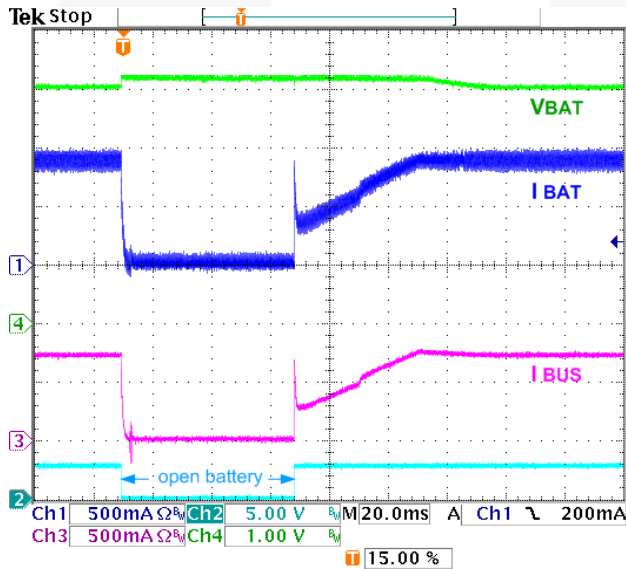

Figure 15. Battery Removal / Insertion during Charging, $V_{BAT}=3.9\text{ V}$, $I_{OCHARGE}=950\text{ mA}$, No I_{NLIM} , $TE=0$

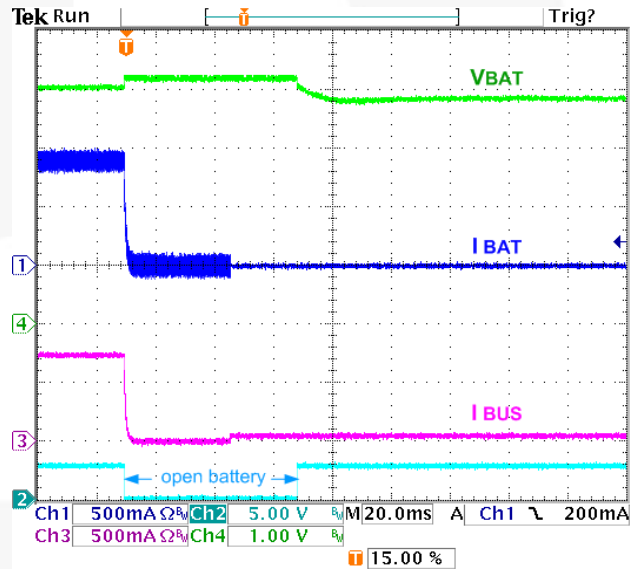

Figure 16. Battery Removal / Insertion during Charging, $V_{BAT}=3.9\text{ V}$, $I_{OCHARGE}=950\text{ mA}$, No I_{NLIM} , $TE=1$

Charge Mode Typical Characteristics

Unless otherwise specified, circuit of Figure 1, $V_{OREG}=4.2\text{ V}$, $V_{BUS}=5.0\text{ V}$, and $T_A=25^\circ\text{C}$.

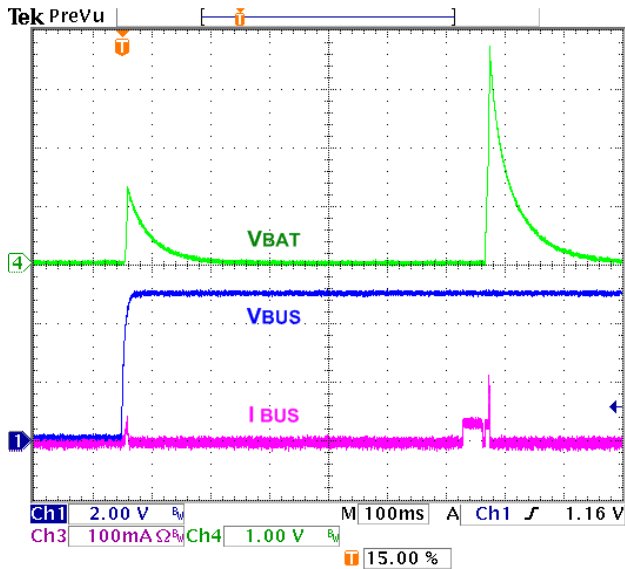

Figure 17. No Battery at V_{BUS} Power-up; FAN5400, FAN5403

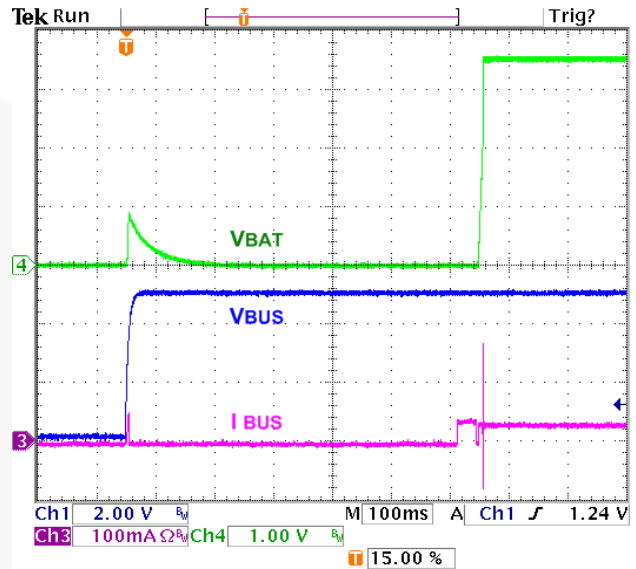

Figure 18. No Battery at V_{BUS} Power-up; FAN5402, FAN5405

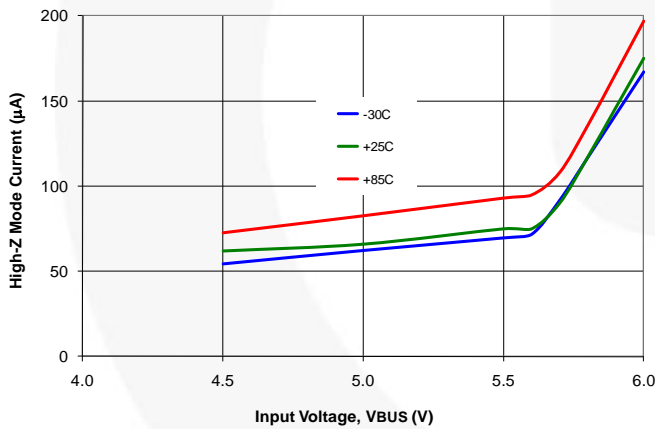

Figure 19. V_{BUS} Current in High-Impedance Mode with Battery Open

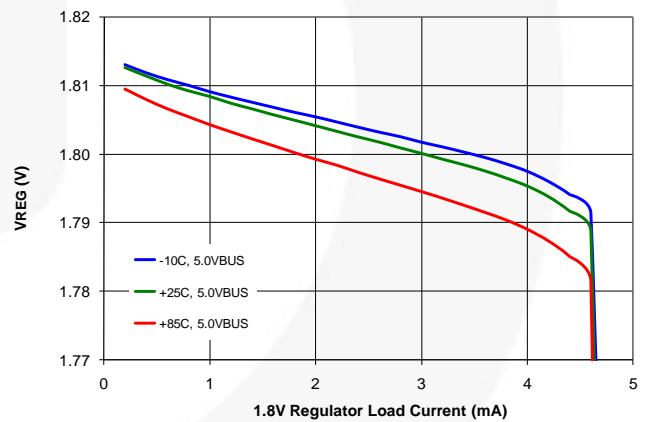

Figure 20. V_{REG} 1.8 V Output Regulation

Boost Mode Typical Characteristics

Unless otherwise specified, using circuit of Figure 1, $V_{BAT}=3.6\text{ V}$, $T_A=25^\circ\text{C}$.

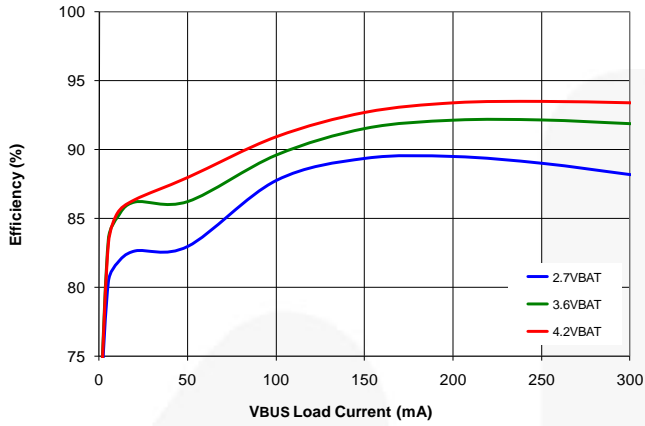

Figure 21. Efficiency vs. V_{BAT}

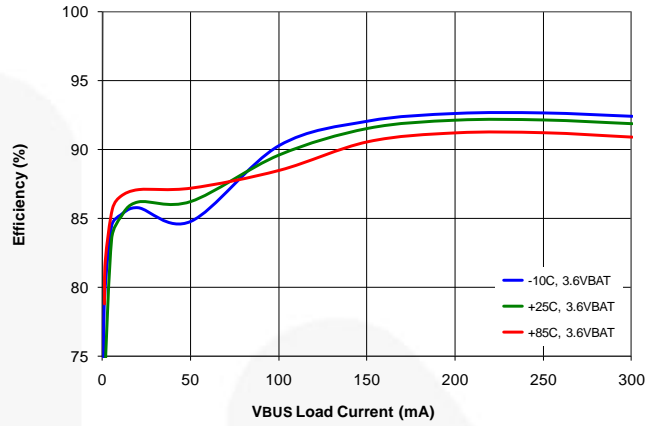

Figure 22. Efficiency Over-Temperature

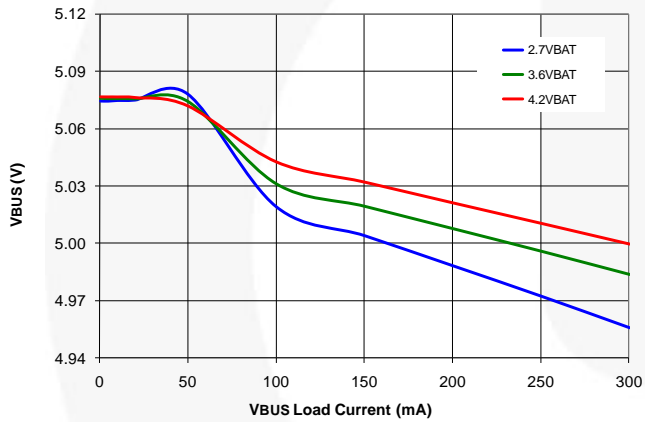

Figure 23. Output Regulation vs. V_{BAT}

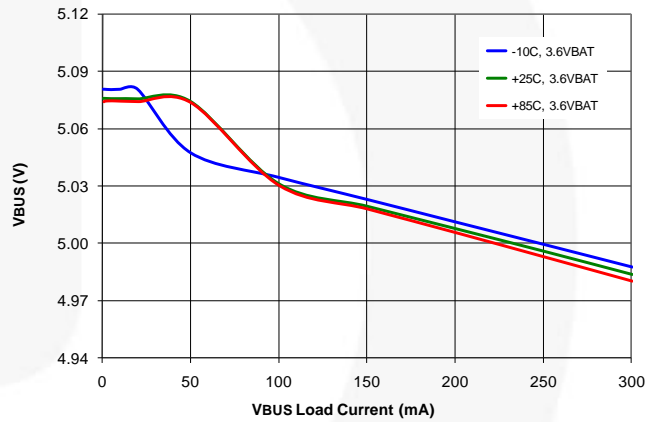

Figure 24. Output Regulation Over-Temperature

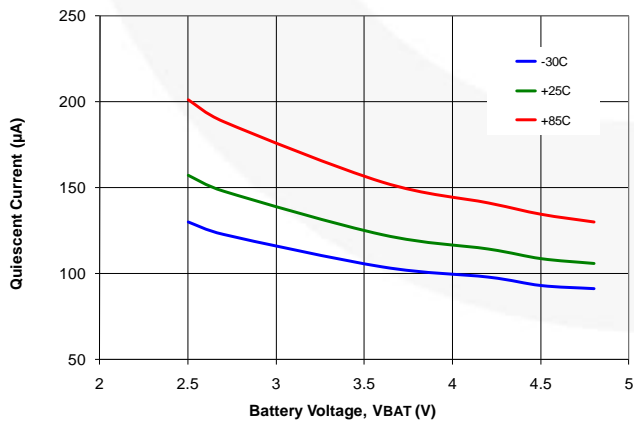

Figure 25. Quiescent Current

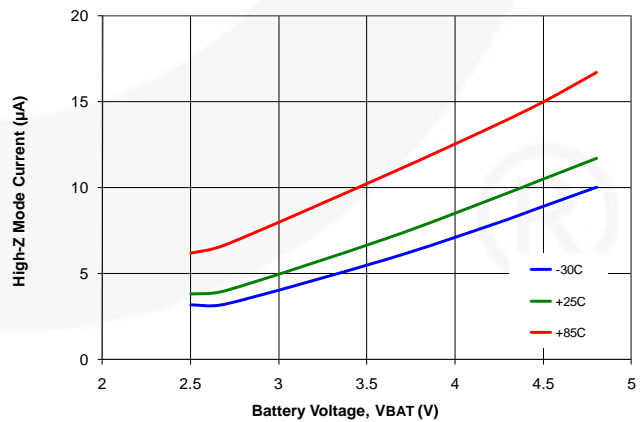

Figure 26. High-Impedance Mode Battery Current

Boost Mode Typical Characteristics

Unless otherwise specified, using circuit of Figure 1, $V_{BAT}=3.6\text{ V}$, $T_A=25^\circ\text{C}$.

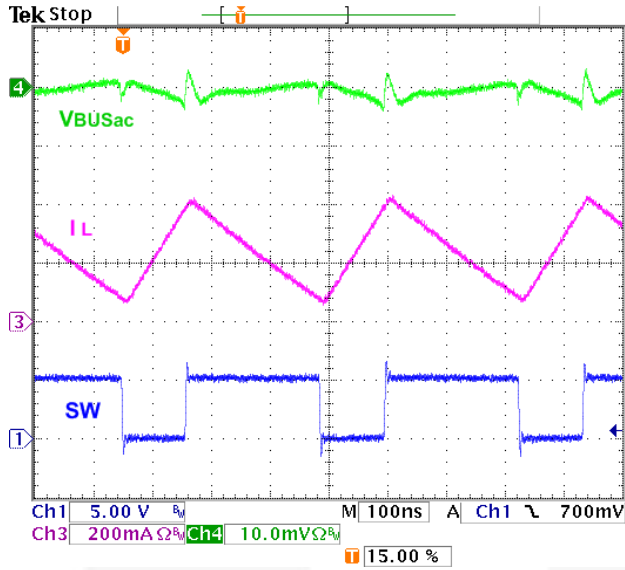

Figure 27. Boost PWM Waveform

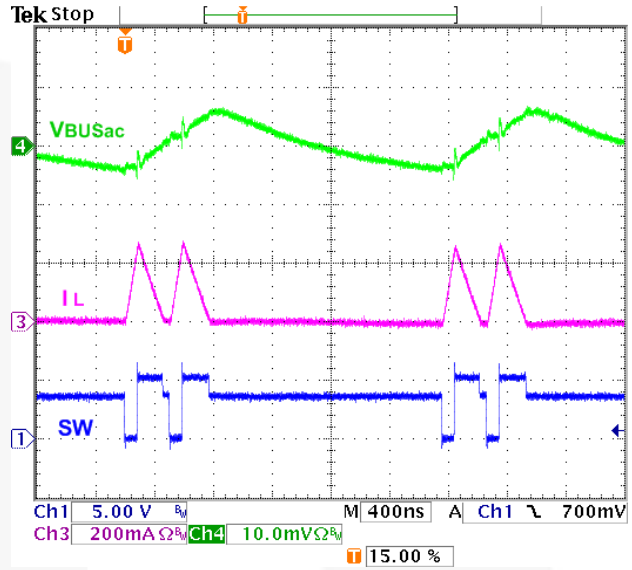

Figure 28. Boost PFM Waveform

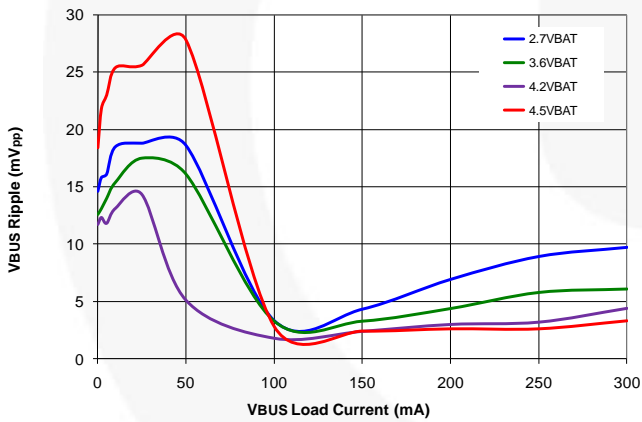

Figure 29. Output Ripple vs. V_{BAT}

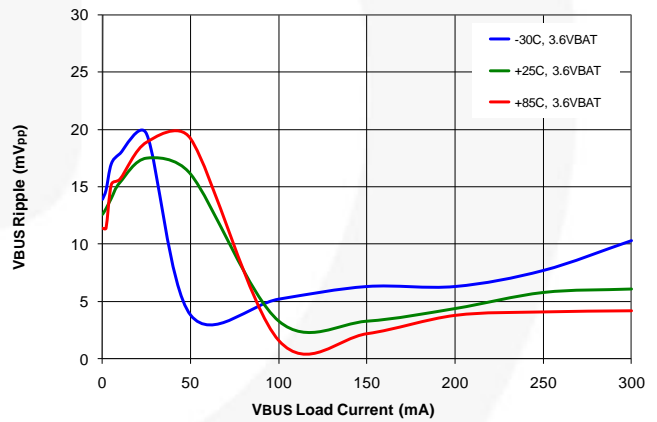

Figure 30. Output Ripple vs. Temperature

Boost Mode Typical Characteristics

Unless otherwise specified, using circuit of Figure 1, $V_{BAT}=3.6\text{ V}$, $T_A=25^\circ\text{C}$.

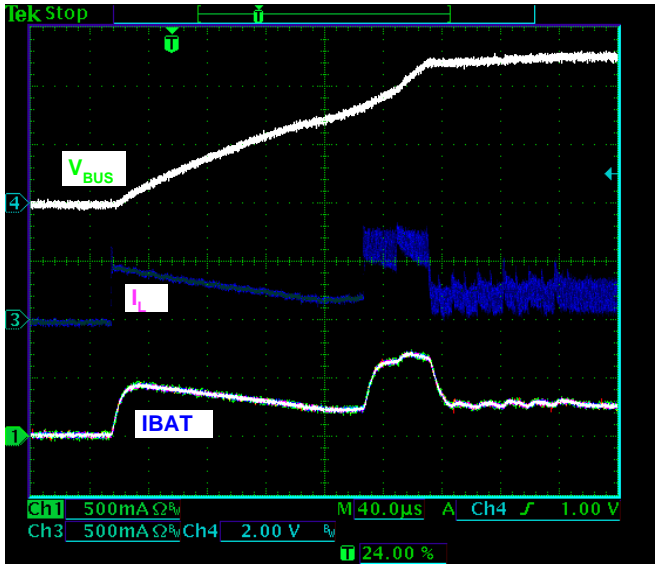

Figure 31. Startup, 3.6 V_{BAT} , 44 Ω Load, Additional 10 μF , X5R Across V_{BUS}

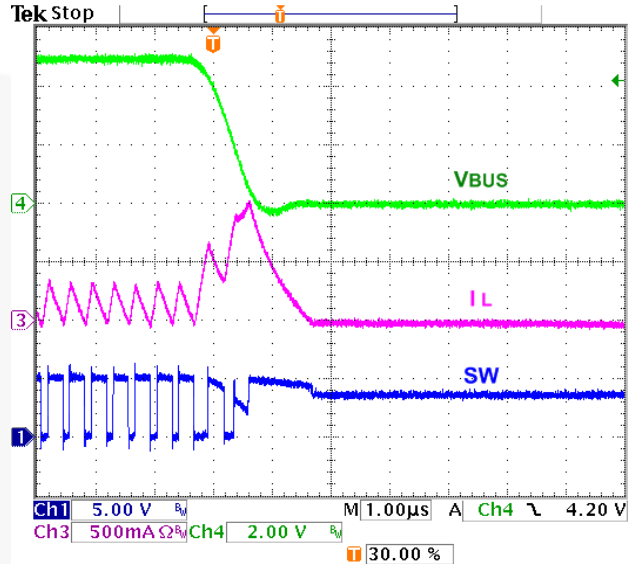

Figure 32. V_{BUS} Fault Response, 3.6 V_{BAT}

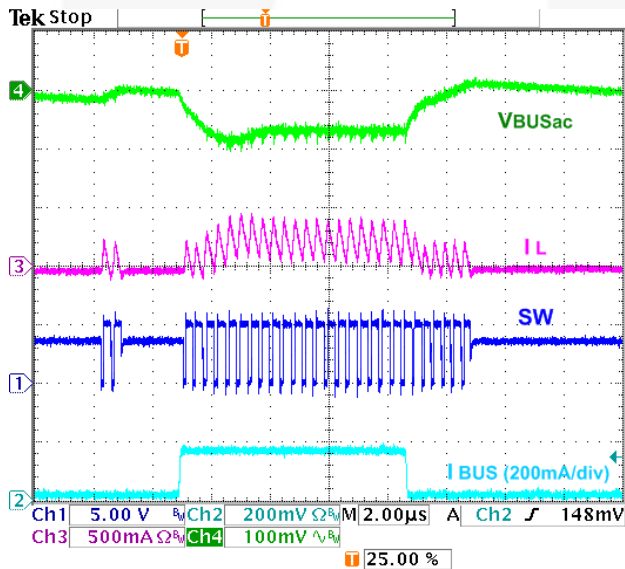

Figure 33. Load Transient, 5-155-5 mA, $t_R=t_F=100\text{ ns}$

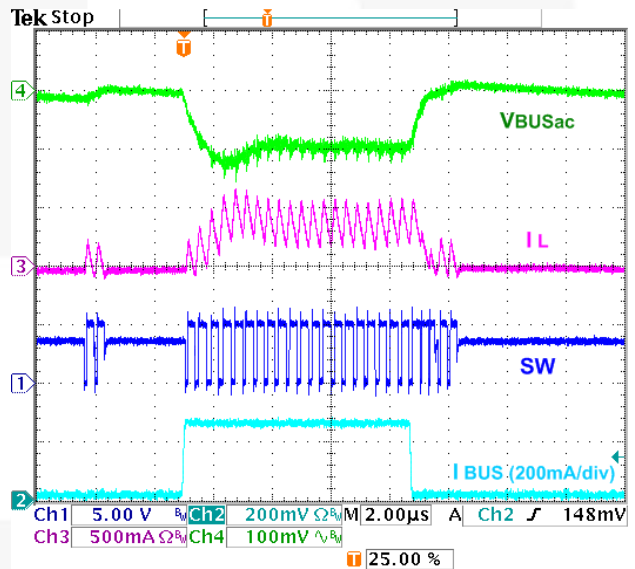

Figure 34. Load Transient, 5-255-5 mA, $t_R=t_F=100\text{ ns}$

Circuit Description / Overview

When charging batteries with a current-limited input source, such as USB, a switching charger's high efficiency over a wide range of output voltages minimizes charging time.

FAN540X combines a highly integrated synchronous buck regulator for charging with a synchronous boost regulator, which can supply 5 V to USB On-The-Go (OTG) peripherals. The regulator employs synchronous rectification for both the charger and boost regulators to maintain high efficiency over a wide range of battery voltages and charge states.

The FAN540X has three operating modes:

1. **Charge Mode:**
Charges a single-cell Li-ion or Li-polymer battery.
2. **Boost Mode:**
Provides 5 V power to USB-OTG with an integrated synchronous rectification boost regulator using the battery as input.
3. **High-Impedance Mode:**
Both the boost and charging circuits are OFF in this mode. Current flow from VBUS to the battery or from the battery to VBUS is blocked in this mode. This mode consumes very little current from VBUS or the battery.

Note: Default settings are denoted by **bold typeface**.

Charge Mode

In Charge Mode, FAN540X employs four regulation loops:

1. **Input Current:** Limits the amount of current drawn from VBUS. This current is sensed internally and can be programmed through the I²C interface.
2. **Charging Current:** Limits the maximum charging current. This current is sensed using an external R_{SENSE} resistor.
3. **Charge Voltage:** The regulator is restricted from exceeding this voltage. As the internal battery voltage rises, the battery's internal impedance and R_{SENSE} work in conjunction with the charge voltage regulation to decrease the amount of current flowing to the battery. Battery charging is completed when the voltage across R_{SENSE} drops below the I_{TERM} threshold.
4. **Temperature:** If the IC's junction temperature reaches 120°C, charge current is continuously reduced until the IC's temperature stabilizes at 120°C.

In addition, the FAN5403-05 employ an additional loop to limit the amount of drop on VBUS to a programmable voltage (V_{SP}) to accommodate "special chargers" that limit current to a lower current than might be available from a "normal" USB wall charger.

Battery Charging Curve

If the battery voltage is below V_{SHORT}, a linear current source pre-charges the battery until V_{BAT} reaches V_{SHORT}. The PWM charging circuit is then started and the battery is charged

with a constant current if sufficient input power is available. The current slew rate is limited to prevent overshoot.

The FAN540X is designed to work with a current-limited input source at VBUS. During the current regulation phase of charging, I_{INLIM} or the programmed charging current limits the amount of current available to charge the battery and power the system. The effect of I_{INLIM} on I_{CHARGE} can be seen in Figure 36.

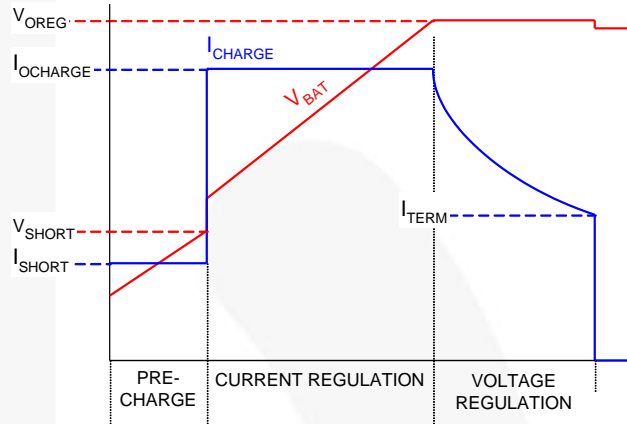

Figure 35. Charge Curve, I_{CHARGE} Not Limited by I_{INLIM}

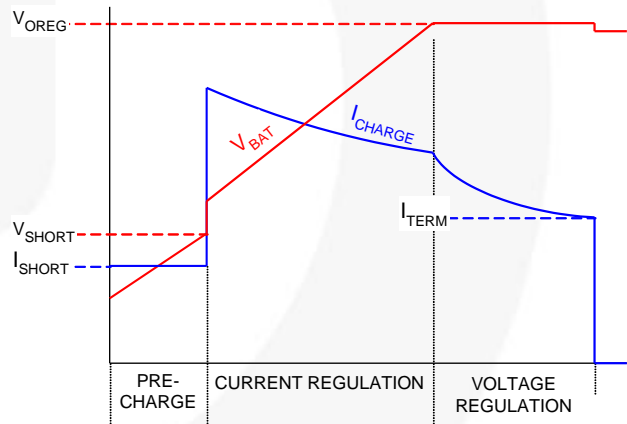

Figure 36. Charge Curve, I_{INLIM} Limits I_{CHARGE}

Assuming that V_{OREG} is programmed to the cell's fully charged "float" voltage, the current that the battery accepts with the PWM regulator limiting its output (sensed at V_{BAT}) to V_{OREG} declines, and the charger enters the voltage regulation phase of charging. When the current declines to the programmed I_{TERM} value, the charge cycle is complete. Charge current termination can be disabled by resetting the TE bit (REG1[3]).

The charger output or "float" voltage can be programmed by the OREG bits from 3.5 V to 4.44 V in 20 mV increments, as shown in Table 3.

Table 3. OREG Bits (OREG[7:2]) vs. Charger V_{OUT} (V_{OREG}) Float Voltage

Decimal	Hex	VOREG	Decimal	Hex	VOREG
0	00	3.50	32	20	4.14
1	01	3.52	33	21	4.16
2	02	3.54	34	22	4.18
3	03	3.56	35	23	4.20
4	04	3.58	36	24	4.22
5	05	3.60	37	25	4.24
6	06	3.62	38	26	4.26
7	07	3.64	39	27	4.28
8	08	3.66	40	28	4.30
9	09	3.68	41	29	4.32
10	0A	3.70	42	2A	4.34
11	0B	3.72	43	2B	4.36
12	0C	3.74	44	2C	4.38
13	0D	3.76	45	2D	4.40
14	0E	3.78	46	2E	4.42
15	0F	3.80	47	2F	4.44
16	10	3.82	48	30	4.44
17	11	3.84	49	31	4.44
18	12	3.86	50	32	4.44
19	13	3.88	51	33	4.44
20	14	3.90	52	34	4.44
21	15	3.92	53	35	4.44
22	16	3.94	54	36	4.44
23	17	3.96	55	37	4.44
24	18	3.98	56	38	4.44
25	19	4.00	57	39	4.44
26	1A	4.02	58	3A	4.44
27	1B	4.04	59	3B	4.44
28	1C	4.06	60	3C	4.44
29	1D	4.08	61	3D	4.44
30	1E	4.10	62	3E	4.44

The following charging parameters can be programmed by the host through I²C:

Table 4. Programmable Charging Parameters

Parameter	Name	Register
Output Voltage Regulation	V _{OREG}	REG2[7:2]
Battery Charging Current Limit	I _{CHRG}	REG4[6:4]
Input Current Limit	I _{INLIM}	REG1[7:6]
Charge Termination Limit	I _{TERM}	REG4[2:0]
Weak Battery Voltage	V _{LOWV}	REG1[5:4]

A new charge cycle begins when one of the following occurs:

- The battery voltage falls below V_{OREG} - V_{RCH}
- VBUS Power On Reset (POR) clears and the battery voltage is below the weak battery threshold (V_{LOWV}). **This occurs for all versions except the FAN5401.**
- $\overline{\text{CE}}$ or HZ_MODE is reset through I²C write to CONTROL1 (R1) register.

Charge Current Limit (I_{CHARGE})

Table 5. I_{CHARGE} (REG4 [6:4]) Current as Function of I_{CHARGE} Bits and R_{SENSE} Resistor Values

DEC	BIN	HEX	V _{RSENSE} (mV)	I _{CHARGE} (mA)	
				68 mΩ	100 mΩ
0	000	00	37.4	550	374
1	001	01	44.2	650	442
2	010	02	51.0	750	510
3	011	03	57.8	850	578
4	100	04	64.6	950	646
5	101	05	71.4	1050	714
6	110	06	78.2	1150	782
7	111	07	85.0	1250	850

Termination Current Limit

Current charge termination is enabled when TE (REG1[3])=1. Typical termination current values are given in Table 6.

Table 6. I_{TERM} Current as Function of I_{TERM} Bits (REG4[2:0]) and R_{SENSE} Resistor Values

I _{TERM}	FAN5400 - FAN5402			FAN5403 - FAN5405		
	V _{RSENSE} (mV)	I _{TERM} (mA)		V _{RSENSE} (mV)	I _{TERM} (mA)	
		68 mΩ	100 mΩ		68 mΩ	100 mΩ
0	3.4	50	34	3.3	49	33
1	6.8	100	68	6.6	97	66
2	10.2	150	102	9.9	146	99
3	13.6	200	136	13.2	194	132
4	17.0	250	170	16.5	243	165
5	20.4	300	204	19.8	291	198
6	23.8	350	238	23.1	340	231
7	27.2	400	272	26.4	388	264

When the charge current falls below I_{TERM} for a period of 32 ms; PWM charging stops and the STAT bits change to READY (00) for about 500 ms while the IC determines whether the battery and charging source are still connected. The STAT bits then change to CHARGE DONE (10), provided the battery and charger are still connected.

PWM Controller in Charge Mode

The IC uses a current-mode PWM controller to regulate the output voltage and battery charge currents. The synchronous rectifier (Q2) has a negative current limit that turns off Q2 at 140 mA to prevent current flow from the battery.

Safety Timer

This section references Figure 41 and Figure 42.

At the beginning of charging, the IC starts a 15-minute timer (t_{15MIN}). When this timer times out, charging is terminated. Writing to any register through I²C stops and resets the t_{15MIN} timer, which in turn starts a 32-second timer (t_{32S}). Setting the TMR_RST bit (REG0[7]) resets the t_{32S} timer. If the t_{32S} timer times out, charging is terminated, the registers are set to their default values, and charging resumes using the default values with the t_{15MIN} timer running.

Normal charging is controlled by the host with the t_{32S} timer running to ensure that the host is alive. Charging with the t_{15MIN} timer running is used for charging that is unattended by the host. If the t_{15MIN} timer expires, the IC turns off the charger, sets the \overline{CE} bit, and indicates a timer fault (110) on the FAULT bits (REG0[2:0]). This sequence prevents overcharge if the host fails to reset the t_{32S} timer.

V_{BUS} POR / Non-Compliant Charger Rejection

When the IC detects that V_{BUS} has risen above V_{IN(MIN)1} (4.4 V), the IC applies a 110 Ω load from V_{BUS} to GND. To clear the V_{BUS} POR (Power-On-Reset) and begin charging, V_{BUS} must remain above V_{IN(MIN)1} and below V_{BUS(OVP)} for t_{VBUS_VALID} (30 ms) before the IC initiates charging. The V_{BUS} validation sequence always occurs before charging is initiated or re-initiated (for example, after a V_{BUS} OVP fault or a V_{RCH} recharge initiation).

t_{VBUS_VALID} ensures that unfiltered 50 / 60 Hz chargers and other non-compliant chargers are rejected.

USB-Friendly Boot Sequence

For all versions except FAN5401, FAN5404

At V_{BUS} POR, when the battery voltage is above the weak battery threshold (V_{LOWV}), the IC operates in accordance with its I²C register settings. If V_{BAT} < V_{LOWV}, the IC sets all registers to their default values and enables the charger using an input current limit controlled by the OTG pin (100 mA if OTG is LOW and 500 mA if OTG is HIGH). This feature can revive a battery whose voltage is too low to ensure reliable host operation. Charging continues in the absence of host communication even after the battery has reached V_{OREG}, whose default value is 3.54 V, and the charger remains active until t_{15MIN} times out. Once the host processor begins writing to the IC, charging parameters are set by the host, which must continually reset the t_{32S} timer to continue charging using the programmed charging parameters. If t_{32S} times out, the register defaults are loaded, the FAULT bits are set to 110, STAT is pulsed HIGH, and charging continues with default charge parameters.

The FAN5401 and FAN5404 do not automatically initiate charging at V_{BUS} POR. Instead, they wait for the host to initiate charging through I²C commands.

Input Current Limiting

To minimize charging time without overloading V_{BUS} current limitations, the IC's input current limit can be programmed by the I_{INLIM} bits (REG1[7:6]).

Table 7. Input Current Limit

I _{INLIM} REG1[7:6]	Input Current Limit
00	100 mA
01	500 mA
10	800 mA
11	No limit

For all versions except the FAN5401 and FAN5404, the OTG pin establishes the input current limit when t_{15MIN} is running. For the FAN5401 and FAN5404, no charging occurs automatically at V_{BUS} POR, so the input current limit is established by the I_{INLIM} bits.

Flow Charts

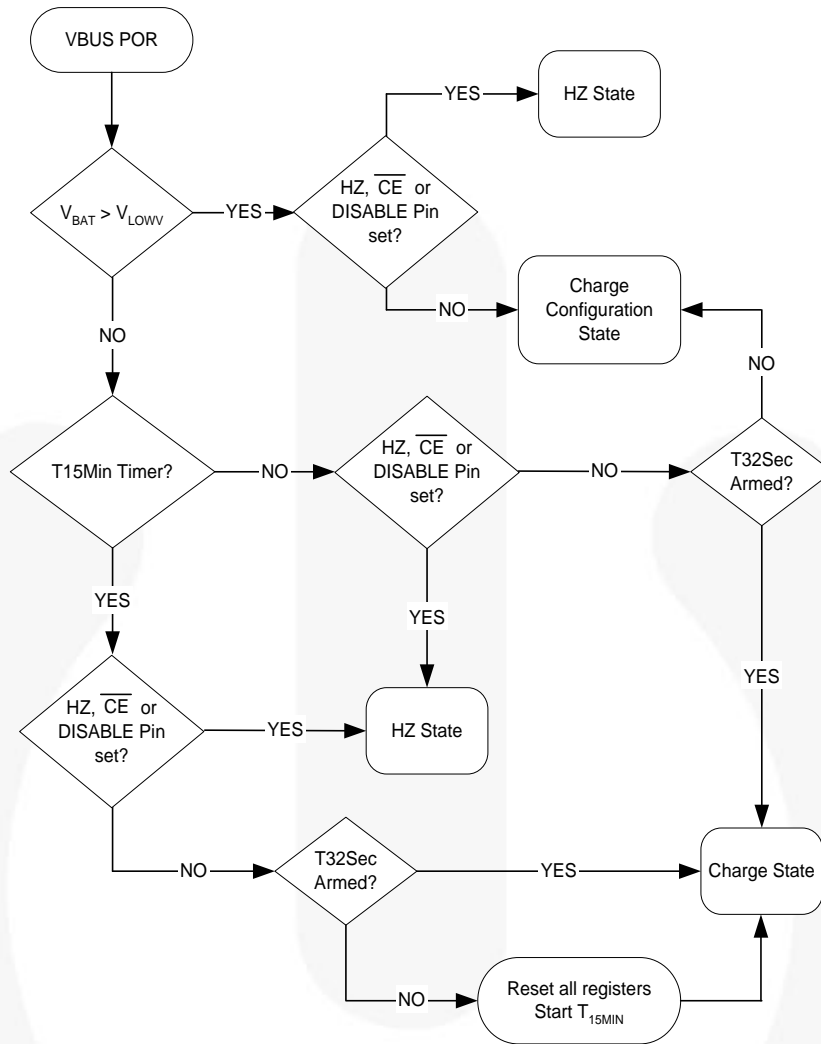

Figure 37. Charger VBUS POR

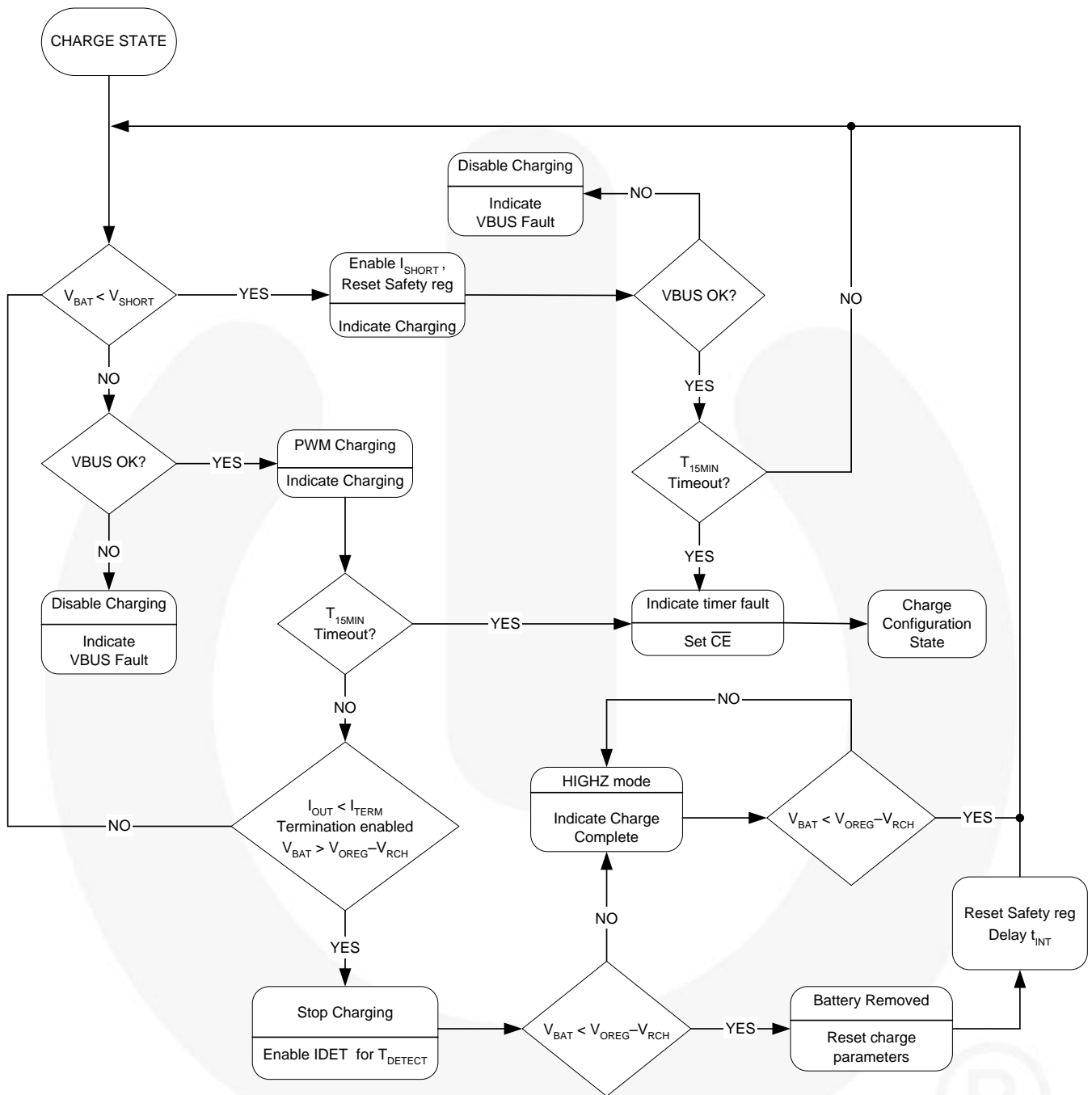

Figure 38. Charge Mode

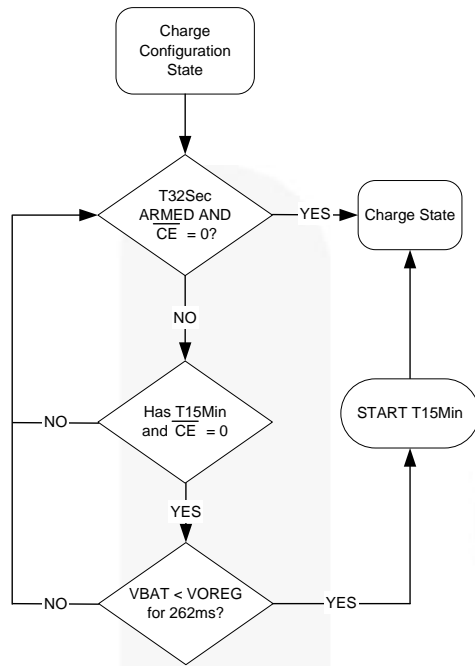

Figure 39. Charge Configuration

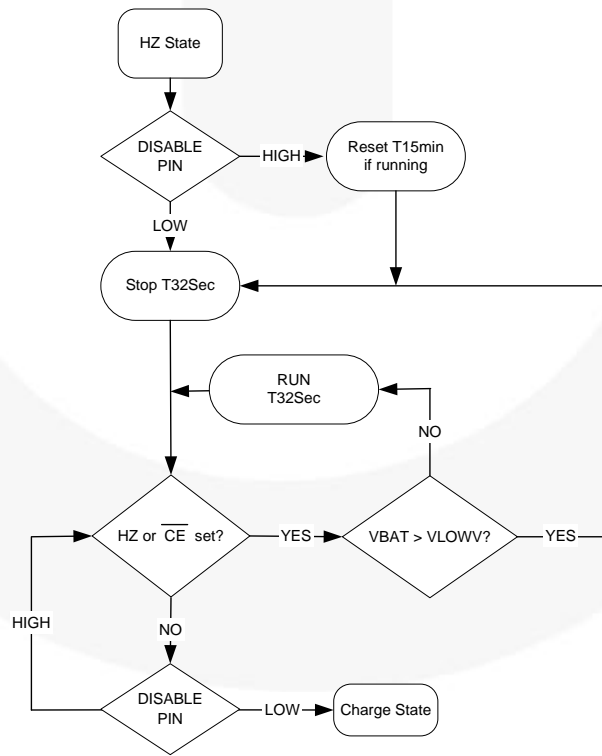

Figure 40. HZ-State

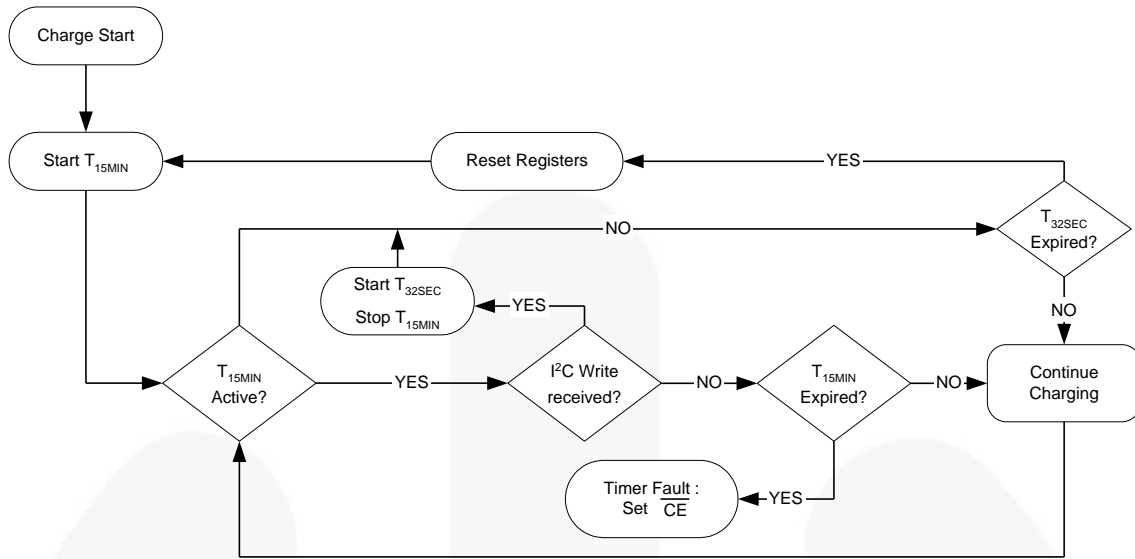

Figure 41. Timer Flow Chart for FAN5400, FAN5402, FAN5403, FAN5405

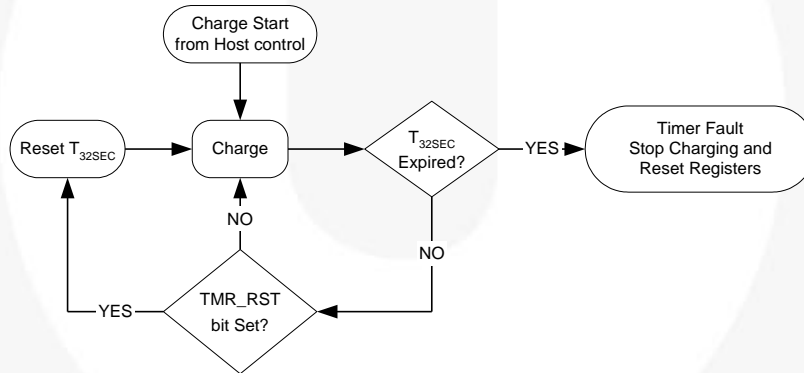

Figure 42. Timer Flow Chart for FAN5401, FAN5404

Special Charger

FAN5403-05 Only

The FAN5403, FAN5404, and FAN5405 have additional functionality to limit input current in case a current-limited “special charger” is supplying VBUS. The FAN5403-05 slowly increases the charging current until either:

- I_{NLIM} or $I_{OCHARGE}$ is reached
- or
- $V_{BUS}=V_{SP}$.

If V_{BUS} collapses to V_{SP} when the current is ramping up, the FAN5403-05 charge with an input current that keeps $V_{BUS}=V_{SP}$. When the V_{SP} control loop is limiting the charge current, the SP bit (REG5[4]) is set.

Table 8. V_{SP} as Function of SP Bits (REG5[2:0])

SP (REG5[2:0])			
DEC	BIN	HEX	V_{SP}
0	000	00	4.213
1	001	01	4.293
2	010	02	4.373
3	011	03	4.453
4	100	04	4.533
5	101	05	4.613
6	110	06	4.693
7	111	07	4.773

Safety Settings

FAN5403-FAN5405 Only

The FAN5403-05 contain a SAFETY register (REG6) that prevents the values in OREG (REG2[7:2]) and IOCHARGE (REG4[6:4]) from exceeding the values of the VSAFE and ISAFE values.

After V_{BAT} exceeds V_{SHORT} , the SAFETY register is loaded with its default value and may be written only before any other register is written. After writing to any other register, the SAFETY register is locked until V_{BAT} falls below V_{SHORT} .

The ISAFE (REG6[6:4]) and VSAFE (REG6[3:0]) registers establish values that limit the maximum values of $I_{OCHARGE}$ and V_{OREG} used by the control logic. If the host attempts to write a value higher than VSAFE or ISAFE to OREG or IOCHARGE, respectively; the VSAFE, ISAFE value appears as the OREG, IOCHARGE register value, respectively.

Table 9. I_{SAFE} ($I_{OCHARGE}$ Limit) as Function of ISAFE Bits (REG6[6:4])

ISAFE (REG6[6:4])			V_{RSENSE} (mV)	I_{SAFE} (mA)	
DEC	BIN	HEX		68 mΩ	100 mΩ
0	000	00	37.4	550	374
1	001	01	44.2	650	442
2	010	02	51.0	750	510
3	011	03	57.8	850	578
4	100	04	64.6	950	646
5	101	05	71.4	1050	714
6	110	06	78.2	1150	782
7	111	07	85.0	1250	850

Table 10. V_{SAFE} (V_{OREG} Limit) as Function of VSAFE Bits (REG6[3:0])

VSAFE (REG6[3:0])			Max. OREG (REG2[7:2])	VOREG Max.
DEC	BIN	HEX		
0	0000	00	100011	4.20
1	0001	01	100100	4.22
2	0010	02	100101	4.24
3	0011	03	100110	4.26
4	0100	04	100111	4.28
5	0101	05	101000	4.30
6	0110	06	101001	4.32
7	0111	07	101010	4.34
8	1000	08	101011	4.36
9	1001	09	101100	4.38
10	1010	0A	101101	4.40
11	1011	0B	101110	4.42
12	1100	0C	101111	4.44
13	1101	0D	110000	4.44
14	1110	0E	110001	4.44
15	1111	0F	110010	4.44

Thermal Regulation and Protection

When the IC’s junction temperature reaches T_{CF} (about 120°C), the charger reduces its output current to 550 mA to prevent overheating. If the temperature increases beyond $T_{SHUTDOWN}$; charging is suspended, the FAULT bits are set to 101, and STAT is pulsed HIGH. In Suspend Mode, all timers stop and the state of the IC’s logic is preserved. Charging resumes at programmed current after the die cools to about 120°C.

Additional θ_{JA} data points, measured using the FAN540X evaluation board, are given in Table 11 (measured with $T_A=25^\circ\text{C}$). Note that as power dissipation increases, the effective θ_{JA} decreases due to the larger difference between the die temperature and its ambient.

Table 11. FAN5400 Evaluation Board Measured θ_{JA}

Power (W)	θ_{JA}
0.504	54°C / W
0.844	50°C / W
1.506	46°C / W

Charge Mode Input Supply Protection

Sleep Mode

When V_{BUS} falls below $V_{BAT} + V_{SLP}$, and V_{BUS} is above $V_{IN(MIN)}$, the IC enters Sleep Mode to prevent the battery from draining into V_{BUS} . During Sleep Mode, reverse current is disabled by body switching Q1.

Input Supply Low-Voltage Detection

The IC continuously monitors V_{BUS} during charging. If V_{BUS} falls below $V_{IN(MIN)}$, the IC:

1. Terminates charging
2. Pulses the STAT pin, sets the STAT bits to 11, and sets the FAULT bits to 011.

If V_{BUS} recovers above the $V_{IN(MIN)}$ rising threshold after time t_{INT} (about two seconds), the charging process is repeated. This function prevents the USB power bus from collapsing or oscillating when the IC is connected to a suspended USB port or a low-current-capable OTG device.

Input Over-Voltage Detection

When the V_{BUS} exceeds $V_{BUS(OVP)}$, the IC:

1. Turns off Q3
2. Suspends charging
3. Sets the FAULT bits to 001, sets the STAT bits to 11, and pulses the STAT pin.

When V_{BUS} falls about 150 mV below $V_{BUS(OVP)}$, the fault is cleared and charging resumes after V_{BUS} is revalidated (see *VBUS POR / Non-Compliant Charger Rejection*).

VBUS Short While Charging

If V_{BUS} is shorted with a very low impedance while the IC is charging with $I_{INLIMIT}=100\text{ mA}$, the IC may not meet datasheet specifications until power is removed. To trigger this condition, V_{BUS} must be driven from 5 V to GND with a high slew rate. Achieving this slew rate requires a $0\ \Omega$ short to the USB cable less than 10cm from the connector.

Charge Mode Battery Detection & Protection

VBAT Over-Voltage Protection

The OREG voltage regulation loop prevents V_{BAT} from overshooting the OREG voltage by more than 50 mV when the battery is removed. When the PWM charger runs with no battery, the TE bit is not set and a battery is inserted that is charged to a voltage higher than V_{OREG} ; PWM pulses stop. If no further pulses occur for 30 ms, the IC sets the FAULT bits to 100, sets the STAT bits to 11, and pulses the STAT pin.

Battery Detection During Charging

The IC can detect the presence, absence, or removal of a battery if the termination bit (TE) is set. During normal charging, once V_{BAT} is close to V_{OREG} and the termination charge current is detected, the IC terminates charging and sets the STAT bits to 10. It then turns on a discharge current, I_{DETECT} , for t_{DETECT} . If V_{BAT} is still above $V_{OREG} - V_{RCH}$, the battery is present and the IC sets the FAULT bits to 000. If V_{BAT} is below $V_{OREG} - V_{RCH}$, the battery is absent and the IC:

1. Sets the registers to their default values.
2. Sets the FAULT bits to 111.
3. Resumes charging with default values after t_{INT} .

Battery Short-Circuit Protection

If the battery voltage is below the short-circuit threshold (V_{SHORT}); a linear current source, I_{SHORT} , supplies V_{BAT} until $V_{BAT} > V_{SHORT}$.

Battery Detection During Power-up

For FAN5400 and FAN5403

At V_{BUS} POR, a 5 k Ω load is applied to V_{BAT} for 500 ms to discharge any residual system capacitance in case the battery is absent. If $V_{BAT} < V_{SHORT}$, linear charging commences. When V_{BAT} rises above V_{SHORT} , PWM charging proceeds with the float voltage (OREG) temporarily set to 4 V. If the battery voltage exceeds 3.7 V within 32 ms of the beginning of PWM charging, the battery is absent. If battery absent is detected:

1. High-Impedance Mode is entered.
2. FAULT bits are set to 111.
3. The t_{15MIN} timer is disabled until V_{BUS} is removed.

If V_{BAT} remains below 3.7 V during the initial 32 ms period, the float voltage returns to the OREG register setting and PWM charging continues.

System Operation with No Battery

The FAN5402 and FAN5405 continue charging after V_{BUS} POR with the default parameters, regulating the V_{BAT} line to 3.54 V until the host processor issues commands or the 15-minute timer expires. In this way, the FAN5402 and FAN5405 can start the system without a battery.

The FAN540X soft-start function can interfere with the system supply with battery absent. The soft-start activates whenever V_{OREG} , I_{INLIM} , or $I_{OCHARGE}$ are set from a lower to higher value. During soft-start, the I_{IN} limit drops to 100 mA for about 1 ms unless I_{INLIM} is set to 11 (no limit). This could cause the system processor to fail to start. To avoid this behavior, use the following sequence.

1. Set the OTG pin HIGH. When V_{BUS} is plugged in, I_{INLIM} is set to 500 mA until the system processor powers up and can set parameters through I²C.
2. Program the Safety Register.
3. Set I_{INLIM} to 11 (no limit).
4. Set OREG to the desired value (typically 4.18).
5. Reset the IOLEVEL bit, then set IOCHARGE.
6. Set I_{INLIM} to 500mA if a USB source is connected.

During the initial system startup, while the charger IC is being programmed, the system current is limited to 325 mA for 1ms during steps 4 and 5. This is the value of the soft-start I_{CHARGE} current used when I_{NLIM} is set to No Limit.

If the system is powered up without a battery present, the CV bit should be set. When a battery is inserted, the CV bit is cleared.

Charger Status / Fault Status

The STAT pin indicates the operating condition of the IC and provides a fault indicator for interrupt driven systems.

Table 12. STAT Pin Function

EN_STAT	Charge State	STAT Pin
0	X	OPEN
X	Normal Conditions	OPEN
1	Charging	LOW
X	Fault (Charging or Boost)	128 μ s Pulse, then OPEN

The FAULT bits (R0[2:0]) indicate the type of fault in Charge Mode (see Table 13).

Table 13. Fault Status Bits During Charge Mode

Fault Bit			Fault Description
B2	B1	B0	
0	0	0	Normal (No Fault)
0	0	1	VBUS OVP
0	1	0	Sleep Mode
0	1	1	Poor Input Source
1	0	0	Battery OVP
1	0	1	Thermal Shutdown
1	1	0	Timer Fault
1	1	1	No Battery

Charge Mode Control Bits

Setting either HZ_MODE or \overline{CE} through I²C disables the charger and puts the IC into High-Impedance Mode and resets t_{32S} . If $V_{BAT} < V_{LOWV}$ while in High-Impedance Mode, t_{32S} begins running and, when it overflows, all registers (except SAFETY) reset, which enables t_{15MIN} charging on versions with the 15-minute timer.

When t_{15MIN} overflows, the IC sets the \overline{CE} bit and the IC enters High-Impedance Mode. If \overline{CE} was set by t_{15MIN} overflow, a new charge cycle can only be initiated through I²C or VBUS POR.

Setting the RESET bit clears all registers. If HZ_MODE or \overline{CE} bits were set when the RESET bit is set, these bits are also cleared, but the t_{32S} timer is not started, and the IC remains in High-Impedance Mode.

Table 14. FAN5403–FAN5405 DISABLE Pin and \overline{CE} Bit Functionality

Charging	DISABLE Pin	\overline{CE}	HZ_MODE
ENABLE	0	0	0
DISABLE	X	1	X
DISABLE	X	X	1
DISABLE	1	X	X

Raising the DISABLE pin stops t_{32S} from advancing, but does not reset it. If the DISABLE pin is raised during t_{15MIN} charging, the t_{15MIN} timer is reset.

Operational Mode Control

OPA_MODE (REG1[0]) and the HZ_MODE (REG1[1]) bits in conjunction with the FAULT state define the operational mode of the charger.

Table 15. Operation Mode Control

HZ_MODE	OPA_MODE	FAULT	Operation Mode
0	0	0	Charge
0	X	1	Charge Configure
0	1	0	Boost
1	X	X	High Impedance

The IC resets the OPA_MODE bit whenever the boost is deactivated, whether due to a fault or being disabled by setting the HZ_MODE bit.

Boost Mode

Boost Mode can be enabled if the IC is in 32-Second Mode with the OTG pin and OPA_MODE bits as indicated in Table 16. The OTG pin ACTIVE state is 1 if OTG_PL=1 and 0 when OTG_PL=0.

If boost is active using the OTG pin, Boost Mode is initiated even if the HZ_MODE=1. The HZ_MODE bit overrides the OPA_MODE bit.

Table 16. Enabling Boost

OTG_EN	OTG Pin	HZ_MODE	OPA_MODE	BOOST
1	ACTIVE	X	X	Enabled
X	X	0	1	Enabled
X	$\overline{\text{ACTIVE}}$	X	0	Disabled
0	X	1	X	Disabled
1	$\overline{\text{ACTIVE}}$	1	1	Disabled
0	ACTIVE	0	0	Disabled

To remain in Boost Mode, the TMR_RST must be set by the host before the t_{32S} timer times out. If t_{32S} times out in Boost Mode; the IC resets all registers, pulses the STAT pin, sets the FAULT bits to 110, and resets the BOOST bit. VBUS POR or reading R0 clears the fault condition.

Boost PWM Control

The IC uses a minimum on-time and computed minimum off-time to regulate VBUS. The regulator achieves excellent transient response by employing current-mode modulation. This technique causes the regulator to exhibit a load line. During PWM Mode, the output voltage drops slightly as the input current rises. With a constant V_{BAT} , this appears as a constant output resistance.

The “droop” caused by the output resistance when a load is applied allows the regulator to respond smoothly to load transients with no undershoot from the load line. This can be seen in Figure 33 and Figure 43.

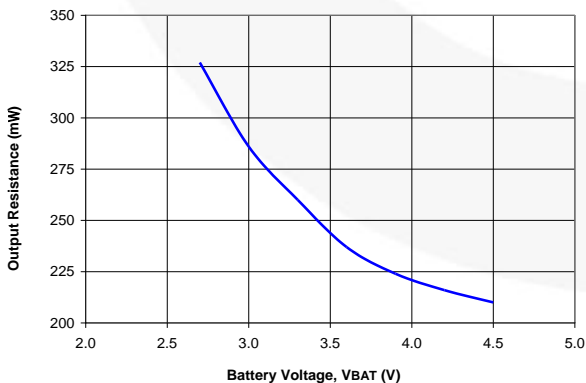

Figure 43. Output Resistance (R_{OUT})

V_{BUS} as a function of I_{LOAD} can be computed when the regulator is in PWM Mode (continuous conduction) as:

$$V_{OUT} = 5.07 - R_{OUT} \cdot I_{LOAD} \quad \text{EQ. 1}$$

At $V_{BAT}=3.3\text{ V}$, and $I_{LOAD}=200\text{ mA}$, V_{BUS} would drop to:

$$V_{OUT} = 5.07 - 0.26 \cdot 0.2 = 5.018\text{V} \quad \text{EQ. 1A}$$

At $V_{BAT}=2.7\text{V}$, and $I_{LOAD}=200\text{mA}$, V_{BUS} would drop to:

$$V_{OUT} = 5.07 - 0.327 \cdot 0.2 = 5.005\text{V} \quad \text{EQ. 1B}$$

PFM Mode

If $V_{BUS} > V_{REF_{BOOST}}$ (nominally 5.07 V) when the minimum off-time has ended, the regulator enters PFM Mode. Boost pulses are inhibited until $V_{BUS} < V_{REF_{BOOST}}$. The minimum on-time is increased to enable the output to pump up sufficiently with each PFM boost pulse. Therefore the regulator behaves like a constant on-time regulator, with the bottom of its output voltage ripple at 5.07 V in PFM Mode.

Table 17. Boost PWM Operating States

Mode	Description	Invoked When
LIN	Linear Startup	$V_{BAT} > V_{BUS}$
SS	Boost Soft-Start	$V_{BUS} < V_{BST}$
BST	Boost Operating Mode	$V_{BAT} > UVLO_{BST}$ and SS Completed

Startup

When the boost regulator is shut down, current flow is prevented from V_{BAT} to V_{BUS} , as well as reverse flow from V_{BUS} to V_{BAT} .

LIN State

When EN rises, if $V_{BAT} > UVLO_{BST}$, the regulator first attempts to bring PMID within 400 mV of V_{BAT} using an internal 450 mA current source from VBAT (LIN State). If PMID has not achieved $V_{BAT} - 400\text{ mV}$ after 560 μs , a FAULT state is initiated.

SS State

When $PMID > V_{BAT} - 400\text{ mV}$, the boost regulator begins switching with a reduced peak current limit of about 50% of its normal current limit. The output slews up until V_{BUS} is within 5% of its set point; at which time, the regulation loop is closed and the current limit is set to 100%.

If the output fails to achieve 95% of its set point (V_{BST}) within 128 μs , the current limit is increased to 100%. If the output fails to achieve 95% of its set point after this second 384 μs period, a fault state is initiated.

BST State

This is the normal operating mode of the regulator. The regulator uses a minimum t_{OFF} -minimum t_{ON} modulation scheme. The minimum t_{OFF} is proportional to $\frac{V_{IN}}{V_{OUT}}$, which

keeps the regulator's switching frequency reasonably constant in CCM. $t_{ON(MIN)}$ is proportional to V_{BAT} and is a higher value if the inductor current reached 0 before $t_{OFF(MIN)}$ in the prior cycle.

To ensure the VBUS does not pump significantly above the regulation point, the boost switch remains off as long as $FB > V_{REF}$.

Boost Faults

If a BOOST fault occurs:

1. The STAT pin pulses.
2. OPA_MODE bit is reset.
3. The power stage is in High-Impedance Mode.
4. The FAULT bits (REG0[2:0]) are set per Table 18.

Restart After Boost Faults

If boost was enabled with the OPA_MODE bit and OTG_EN=0, Boost Mode can only be enabled through subsequent I²C commands since OPA_MODE is reset on boost faults. If OTG_EN=1 and the OTG pin is still ACTIVE (see Table 16), the boost restarts after a 5.2 ms delay, as shown in Figure 44. If the fault condition persists, restart is attempted every 5 ms until the fault clears or an I²C command disables the boost.

Table 18. Fault Bits During Boost Mode

Fault Bit			Fault Description
B2	B1	B0	
0	0	0	Normal (no fault)
0	0	1	$V_{BUS} > V_{BUS_{OVP}}$
0	1	0	V_{BUS} fails to achieve the voltage required to advance to the next state during soft-start or sustained (>50 μ s) current limit during the BST state.
0	1	1	$V_{BAT} < UVLO_{BST}$
1	0	0	N/A: This code does not appear.
1	0	1	Thermal shutdown
1	1	0	Timer fault; all registers reset.
1	1	1	N/A: This code does not appear.

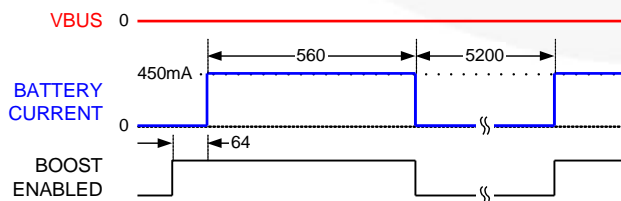

Figure 44. Boost Response Attempting to Start into VBUS Short Circuit (Times in μ s)

VREG Pin

The VREG pin on FAN5400 - FAN5402 provides a voltage protected from over-voltage surges on VBUS, which can be used to run auxiliary circuits. This voltage is essentially a current-limited replica of PMID. The maximum voltage on this node is 5.9 V.

FAN5403-FAN5405 provide a 1.8 V regulated output on this pin, which can be disabled through I²C by setting the DIS_VREG bit (REG5[6]). VREG can supply up to 2 mA. This circuit, which is powered from PMID, is enabled only when PMID > V_{BAT} and does not drain current from the battery. During boost, VREG is off. It is also off when the HZ_MODE bit (REG1[1])=1.

Monitor Register (Reg10h)

Additional status monitoring bits enable the host processor to have more visibility into the status of the IC. The monitor bits are real-time status indicators and are not internally debounced or otherwise time qualified.

The state of the MONITOR register bits listed in High-Impedance Mode are only valid when VBUS is valid.

Table 19. MONITOR Register Bit Definitions

BIT#	NAME	STATE		Active When
		0	1	
MONITOR Address 10h				
7	ITERM_CMP	$V_{CSIN} - V_{BAT} < V_{ITERM}$	$V_{CSIN} - V_{BAT} > V_{ITERM}$	Charging with TE=1
		$V_{CSIN} - V_{BAT} < 1mV$	$V_{CSIN} - V_{BAT} > 1mV$	Charging with TE=0
6	VBAT_CMP	$V_{BAT} < V_{SHORT}$	$V_{BAT} > V_{SHORT}$	Charging
		$V_{BAT} < V_{LOWV}$	$V_{BAT} > V_{LOWV}$	High-Impedance Mode
		$V_{BAT} < UVLO_{BST}$	$V_{BAT} > UVLO_{BST}$	Boosting
5	LINCHG	Linear Charging Not Enabled	Linear Charging Enabled	Charging
4	T_120	$T_J < 120^{\circ}C$	$T_J > 120^{\circ}C$	
3	ICHG	Charging Current Controlled by I_{CHARGE} Control Loop	Charging Current Not Controlled by I_{CHARGE} Control Loop	Charging
2	IBUS	I_{BUS} Limiting Charging Current	Charge Current Not Limited by I_{BUS}	Charging
1	VBUS_VALID	V_{BUS} Not Valid	V_{BUS} is Valid	$V_{BUS} > V_{BAT}$
0	CV	Constant Current Charging	Constant Voltage Charging	Charging

I²C Interface

The FAN540X's serial interface is compatible with Standard, Fast, Fast Plus, and High-Speed Mode I²C-Bus® specifications. The FAN540X's SCL line is an input and its SDA line is a bi-directional open-drain output; it can only pull down the bus when active. The SDA line only pulls LOW during data reads and when signaling ACK. All data is shifted in MSB (bit 7) first.

Slave Address

Table 20. I²C Slave Address Byte

Part Types	7	6	5	4	3	2	1	0
FAN5400–FAN5404	1	1	0	1	0	1	1	R/W
FAN5405	1	1	0	1	0	1	0	R/W

In hex notation, the slave address assumes a 0 LSB. The hex slave address for the FAN5405 is D4h and is D6h for all other parts in the family.

Bus Timing

As shown in Figure 45, data is normally transferred when SCL is LOW. Data is clocked in on the rising edge of SCL. Typically, data transitions shortly at or after the falling edge of SCL to allow ample time for the data to set up before the next SCL rising edge.

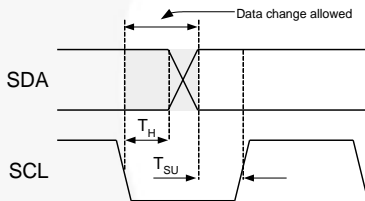

Figure 45. Data Transfer Timing

Each bus transaction begins and ends with SDA and SCL HIGH. A transaction begins with a START condition, which is defined as SDA transitioning from 1 to 0 with SCL HIGH, as shown in Figure 46.

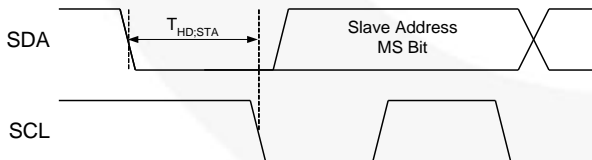

Figure 46. Start Bit

A transaction ends with a STOP condition, which is defined as SDA transitioning from 0 to 1 with SCL HIGH, as shown in Figure 47.

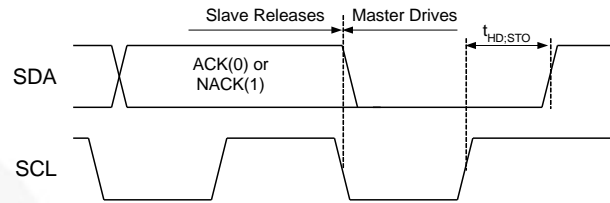

Figure 47. Stop Bit

During a read from the FAN540X (Figure 50), the master issues a Repeated Start after sending the register address and before resending the slave address. The Repeated Start is a 1-to-0 transition on SDA while SCL is HIGH, as shown in Figure 48.

High-Speed (HS) Mode

The protocols for High-Speed (HS), Low-Speed (LS), and Fast-Speed (FS) Modes are identical except the bus speed for HS Mode is 3.4 MHz. HS Mode is entered when the bus master sends the HS master code 00001XXX after a start condition. The master code is sent in Fast or Fast Plus Mode (less than 1MHz clock); slaves do not ACK this transmission.

The master then generates a repeated start condition (Figure 48) that causes all slaves on the bus to switch to HS Mode. The master then sends I²C packets, as described above, using the HS Mode clock rate and timing.

The bus remains in HS Mode until a stop bit (Figure 47) is sent by the master. While in HS Mode, packets are separated by repeated start conditions (Figure 48).

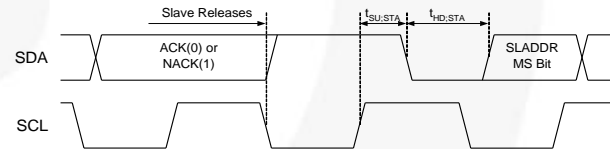

Figure 48. Repeated Start Timing

Read and Write Transactions

The figures below outline the sequences for data read and write. Bus control is signified by the shading of the packet, defined as Master Drives Bus and Slave Drives Bus. All addresses and data are MSB first.

Table 21. Bit Definitions for Figure 49, Figure 50

Symbol	Definition
S	START, see Figure 46.
A	ACK. The slave drives SDA to 0 to acknowledge the preceding packet.
\bar{A}	NACK. The slave sends a 1 to NACK the preceding packet.
R	Repeated START, see Figure 48
P	STOP, see Figure 47

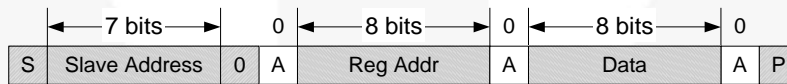

Figure 49. Write Transaction

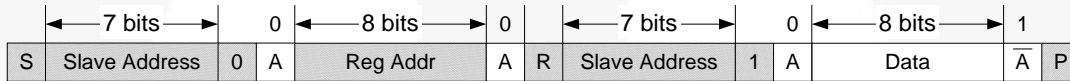

Figure 50. Read Transaction

Register Descriptions

The FAN5400-FAN5402 have seven user-accessible registers; the FAN5403-05 have an additional two registers, as defined in Table 22.

Table 22. I²C Register Address

IC	Register		Address Bits							
	Name	REG#	7	6	5	4	3	2	1	0
ALL	CONTROL0	0	0	0	0	0	0	0	0	0
	CONTROL1	1	0	0	0	0	0	0	0	1
	OREG	2	0	0	0	0	0	0	1	0
	IC_INFO	03 or 3Bh	0	0	0	0	0	0	1	1
	IBAT	4	0	0	0	0	0	1	0	0
FAN5403-FAN5405	SP_CHARGER	5	0	0	0	0	0	1	0	1
	SAFETY	6	0	0	0	0	0	1	1	0
ALL	MONITOR	10h	0	0	0	0	1	0	1	0

Table 23. Register Bit Definitions

This table defines the operation of each register bit for all IC versions. Default values are in **bold** text.

Bit	Name	Value	Type	Description
CONTROL0				Register Address: 00 Default Value=X1XX 0XXX
7	TMR_RST OTG	1	W	Writing a 1 resets the t _{32S} timer; writing a 0 has no effect
			R	Returns the OTG pin level (1=HIGH)
6	EN_STAT	0	R/W	Prevents STAT pin from going LOW during charging; STAT pin still pulses to enunciate faults
			1	Enables STAT pin LOW when IC is charging
5:4	STAT	00	R	Ready
				Charge in progress
				Charge done
				Fault
3	BOOST	0	R	IC is not in Boost Mode
				IC is in Boost Mode
2:0	FAULT		R	Fault status bits: <i>for Charge Mode, see Table 13; for Boost Mode: see Table 18</i>

Table 23. Register Bit Definitions (Continued)

Bit	Name	Value	Type	Description
CONTROL1				Register Address: 01 Default Value=0011 0000 (30h)
7:6	I _{NLIM}		R/W	Input current limit, see Table 7
5:4	V _{LOWV}	00	R/W	3.4 V
		01		3.5 V
		10		3.6 V
		11		3.7 V
3	TE	0	R/W	Disable charge current termination
		1		Enable charge current termination
2	$\overline{\text{CE}}$	0	R/W	Charger enabled
		1		Charger disabled
1	HZ_MODE	0	R/W	Not High-Impedance Mode
		1		High-Impedance Mode
0	OPA_MODE	0	R/W	Charge Mode
		1		Boost Mode
OREG				Register Address: 02 Default Value=0000 1010 (0Ah)
7:2	OREG		R/W	Charger output “float” voltage; programmable from 3.5 to 4.44 V in 20 mV increments; defaults to 000010 (3.54 V) , see Table 3
1	OTG_PL	0	R/W	OTG pin active LOW
		1		OTG pin active HIGH
0	OTG_EN	0	R/W	Disables OTG pin
		1		Enables OTG pin
IC_INFO				Register Address: 03 or 3B Default Value=100X XXXX
7:5	Vendor Code	100	R	Identifies Fairchild Semiconductor as the IC supplier
4:3	PN		R	Part number bits, see the <i>Ordering Info</i> on page 1
2:0	REV		R	IC Revision, revision 1.X, where X is the decimal of these three bits
IBAT				Register Address: 04 Default Value=1000 1001 (89h)
7	RESET	1	W	Writing a 1 resets charge parameters, except the Safety register (Reg6), to their defaults: writing a 0 has no effect; read returns 1
6:4	IOCHARGE	Table 5	R/W	Programs the maximum charge current, see Table 5
3	Reserved	1	R	Unused
2:0	ITERM	Table 6	R/W	Sets the current used for charging termination, see Table 6

Table 23. Register Bit Definitions (Continued)

SP_CHARGER (FAN5403 – FAN5405)			Register Address: 05	Default Value=001X X100
7	Reserved	0	R	Unused
6	DIS_VREG	0	R/W	1.8 V regulator is ON
		1		1.8 V regulator is OFF
5	IO_LEVEL	0	R/W	Output current is controlled by IOCHARGE bits
		1		Voltage across R _{SENSE} for output current control is set to 22.1 mV (325 mA for R _{SENSE} =68 mΩ, 221 mA for 100 mΩ)
4	SP	0	R	Special charger is not active (V _{BUS} is able to stay above V _{SP})
		1		Special charger has been detected and V _{BUS} is being regulated to V _{SP}
3	EN_LEVEL	0	R	DISABLE pin is LOW
		1		DISABLE pin is HIGH
2:0	VSP	Table 8	R/W	Special charger input regulation voltage, <i>see Table 8</i>
SAFETY (FAN5403 – FAN5405)			Register Address: 06	Default Value=0100 0000 (40h)
7	Reserved	0	R	Bit disabled and always returns 0 when read back
6:4	ISAFE	Table 9	R/W	Sets the maximum I _{CHARGE} value used by the control circuit, <i>see Table 9</i>
3:0	VSAFE	Table 10	R/W	Sets the maximum V _{OREG} used by the control circuit, <i>see Table 10</i>
MONITOR			Register Address: 10h (16)	<i>See Table 19</i>
7	ITERM_CMP	See Table 19	R	Real-time ITERM comparator output: 1 when VRSENSE > ITERM reference. Dynamic system loads can cause this bit to toggle between 0 and 1.
6	VBAT_CMP		R	Output of VBAT comparator
5	LINCHG		R	30 mA linear charger ON
4	T_120		R	Thermal regulation comparator; when=1 and T_145=0, the charge current is limited to 22.1 mV across R _{SENSE}
3	ICHG		R	0 indicates the I _{CHARGE} loop is controlling the battery charge current
2	IBUS		R	0 indicates the I _{BUS} (input current) loop is controlling the battery charge current
1	VBUS_VALID		R	1 indicates V _{BUS} has passed validation and is capable of charging
0	CV		R	1 indicates the constant-voltage loop (OREG) is controlling the charger and all current limiting loops have released

PCB Layout Recommendations

Bypass capacitors should be placed as close to the IC as possible. In particular, the total loop length for CMID should be minimized to reduce overshoot and ringing on the SW, PMID, and VBUS pins. All power and ground pins must be

routed to their bypass capacitors using top copper if possible. Copper area connecting to the IC should be maximized to improve thermal performance.

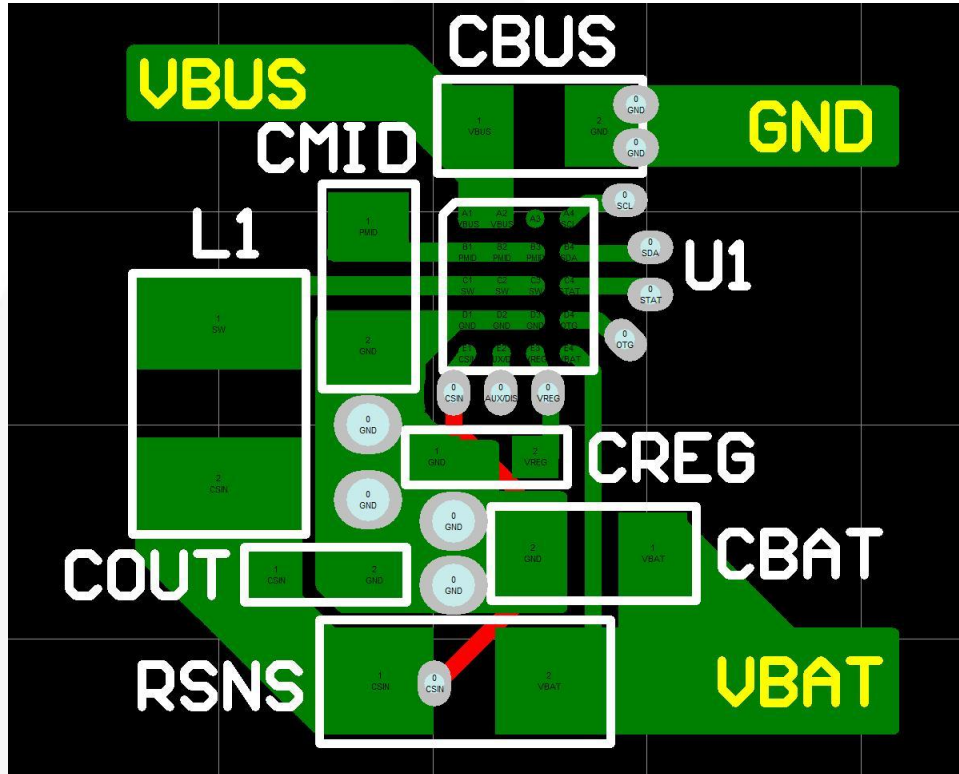
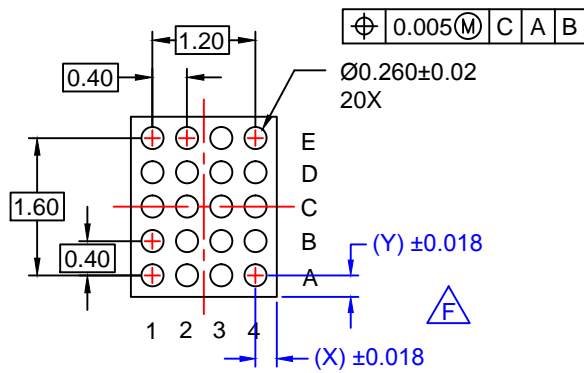
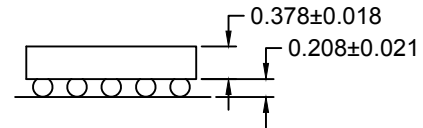
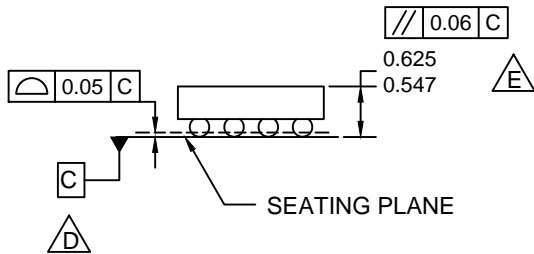
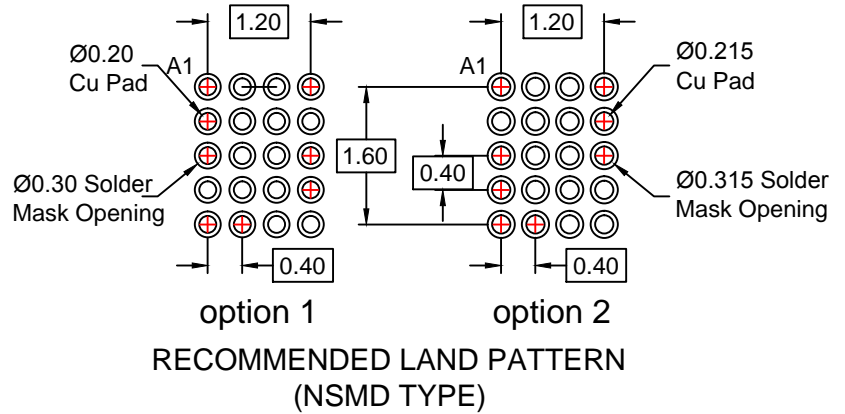
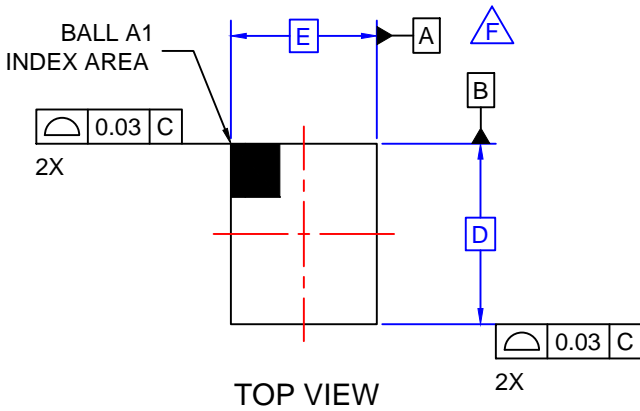

Figure 51. PCB Layout Recommendations

The following information applies to the WLCSP package dimensions on the next page:

Product-Specific Dimensions

Product	D	E	X	Y
FAN540xUCX	1.960 ±0.030	1.870 ±0.030	0.335	0.180



NOTES:

- A. NO JEDEC REGISTRATION APPLIES.
- B. DIMENSIONS ARE IN MILLIMETERS.
- C. DIMENSIONS AND TOLERANCE PER ASMEY14.5M, 2009.
- D. DATUM C IS DEFINED BY THE SPHERICAL CROWNS OF THE BALLS.
- E. PACKAGE NOMINAL HEIGHT IS 586 MICRONS ±39 MICRONS (547-625 MICRONS).
- F. FOR DIMENSIONS D, E, X, AND Y SEE PRODUCT DATASHEET.
- G. DRAWING FILNAME: MKT-UC020AArev4.





TRADEMARKS

The following includes registered and unregistered trademarks and service marks, owned by Fairchild Semiconductor and/or its global subsidiaries, and is not intended to be an exhaustive list of all such trademarks.

- AccuPower™
- AttitudeEngine™
- Awinda®
- AX-CAP®*
- BitSiC™
- Build it Now™
- CorePLUS™
- CorePOWER™
- CROSSVOL™
- CTL™
- Current Transfer Logic™
- DEUXPEED®
- Dual Cool™
- EcoSPARK®
- EfficientMax™
- ESBC™
- F**™
- Fairchild®
- Fairchild Semiconductor®
- FACT Quiet Series™
- FACT®
- FastvCore™
- FETBench™
- FPS™
- F-PFS™
- FRFET®
- Global Power ResourceSM
- GreenBridge™
- Green FPS™
- Green FPS™ e-Series™
- Gmax™
- GTO™
- IntelliMAX™
- ISOPLANAR™
- Making Small Speakers Sound Louder and Better™
- MegaBuck™
- MICROCOUPLER™
- MicroFET™
- MicroPak™
- MicroPak2™
- MillerDrive™
- MotionMax™
- MotionGrid®
- MTi®
- MTx®
- MVN®
- mWSaver®
- OptoHiT™
- OPTOLOGIC®
- OPTOPLANAR®
- ®
- Power Supply WebDesigner™
- PowerTrench®
- PowerXS™
- Programmable Active Droop™
- QFET®
- QS™
- Quiet Series™
- RapidConfigure™
- ™
- Saving our world, 1mW/W/kW at a time™
- SignalWise™
- SmartMax™
- SMART START™
- Solutions for Your Success™
- SPM®
- STEALTH™
- SuperFET®
- SuperSOT™-3
- SuperSOT™-6
- SuperSOT™-8
- SupreMOS®
- SyncFET™
- Sync-Lock™
- ®
- TinyBoost®
- TinyBuck®
- TinyCalc™
- TinyLogic®
- TINYOPTO™
- TinyPower™
- TinyPWM™
- TinyWire™
- TranSiC™
- TriFault Detect™
- TRUECURRENT®*
- μSerDes™
- ™
- UHC®
- Ultra FRFET™
- UniFET™
- VcX™
- VisualMax™
- VoltagePlus™
- XS™
- Xsens™
- 仙童®

* Trademarks of System General Corporation, used under license by Fairchild Semiconductor.

DISCLAIMER

FAIRCHILD SEMICONDUCTOR RESERVES THE RIGHT TO MAKE CHANGES WITHOUT FURTHER NOTICE TO ANY PRODUCTS HEREIN TO IMPROVE RELIABILITY, FUNCTION, OR DESIGN. TO OBTAIN THE LATEST, MOST UP-TO-DATE DATASHEET AND PRODUCT INFORMATION, VISIT OUR WEBSITE AT [HTTP://WWW.FAIRCHILDSEMI.COM](http://www.fairchildsemi.com). FAIRCHILD DOES NOT ASSUME ANY LIABILITY ARISING OUT OF THE APPLICATION OR USE OF ANY PRODUCT OR CIRCUIT DESCRIBED HEREIN; NEITHER DOES IT CONVEY ANY LICENSE UNDER ITS PATENT RIGHTS, NOR THE RIGHTS OF OTHERS. THESE SPECIFICATIONS DO NOT EXPAND THE TERMS OF FAIRCHILD'S WORLDWIDE TERMS AND CONDITIONS, SPECIFICALLY THE WARRANTY THEREIN, WHICH COVERS THESE PRODUCTS.

AUTHORIZED USE

Unless otherwise specified in this data sheet, this product is a standard commercial product and is not intended for use in applications that require extraordinary levels of quality and reliability. This product may not be used in the following applications, unless specifically approved in writing by a Fairchild officer: (1) automotive or other transportation, (2) military/aerospace, (3) any safety critical application – including life critical medical equipment – where the failure of the Fairchild product reasonably would be expected to result in personal injury, death or property damage. Customer's use of this product is subject to agreement of this Authorized Use policy. In the event of an unauthorized use of Fairchild's product, Fairchild accepts no liability in the event of product failure. In other respects, this product shall be subject to Fairchild's Worldwide Terms and Conditions of Sale, unless a separate agreement has been signed by both Parties.

ANTI-COUNTERFEITING POLICY

Fairchild Semiconductor Corporation's Anti-Counterfeiting Policy. Fairchild's Anti-Counterfeiting Policy is also stated on our external website, www.fairchildsemi.com, under Terms of Use

Counterfeiting of semiconductor parts is a growing problem in the industry. All manufacturers of semiconductor products are experiencing counterfeiting of their parts. Customers who inadvertently purchase counterfeit parts experience many problems such as loss of brand reputation, substandard performance, failed applications, and increased cost of production and manufacturing delays. Fairchild is taking strong measures to protect ourselves and our customers from the proliferation of counterfeit parts. Fairchild strongly encourages customers to purchase Fairchild parts either directly from Fairchild or from Authorized Fairchild Distributors who are listed by country on our web page cited above. Products customers buy either from Fairchild directly or from Authorized Fairchild Distributors are genuine parts, have full traceability, meet Fairchild's quality standards for handling and storage and provide access to Fairchild's full range of up-to-date technical and product information. Fairchild and our Authorized Distributors will stand behind all warranties and will appropriately address any warranty issues that may arise. Fairchild will not provide any warranty coverage or other assistance for parts bought from Unauthorized Sources. Fairchild is committed to combat this global problem and encourage our customers to do their part in stopping this practice by buying direct or from authorized distributors.

PRODUCT STATUS DEFINITIONS

Definition of Terms

Datasheet Identification	Product Status	Definition
Advance Information	Formative / In Design	Datasheet contains the design specifications for product development. Specifications may change in any manner without notice.
Preliminary	First Production	Datasheet contains preliminary data; supplementary data will be published at a later date. Fairchild Semiconductor reserves the right to make changes at any time without notice to improve design.
No Identification Needed	Full Production	Datasheet contains final specifications. Fairchild Semiconductor reserves the right to make changes at any time without notice to improve the design.
Obsolete	Not In Production	Datasheet contains specifications on a product that is discontinued by Fairchild Semiconductor. The datasheet is for reference information only.

Rev. I77