

# NSS30100LT1G

## 30 V, 2 A, Low $V_{CE(sat)}$ PNP Transistor

ON Semiconductor's e<sup>2</sup>PowerEdge family of low  $V_{CE(sat)}$  transistors are miniature surface mount devices featuring ultra low saturation voltage ( $V_{CE(sat)}$ ) and high current gain capability. These are designed for use in low voltage, high speed switching applications where affordable efficient energy control is important.

Typical application are DC-DC converters and power management in portable and battery powered products such as cellular and cordless phones, PDAs, computers, printers, digital cameras and MP3 players. Other applications are low voltage motor controls in mass storage products such as disc drives and tape drives. In the automotive industry they can be used in air bag deployment and in the instrument cluster. The high current gain allows e<sup>2</sup>PowerEdge devices to be driven directly from PMU's control outputs, and the Linear Gain (Beta) makes them ideal components in analog amplifiers.

- NSV Prefix for Automotive and Other Applications Requiring Unique Site and Control Change Requirements; AEC-Q101 Qualified and PPAP Capable
- These Devices are Pb-Free, Halogen Free/BFR Free and are RoHS Compliant

### MAXIMUM RATINGS ( $T_A = 25^\circ\text{C}$ )

Rating	Symbol	Max	Unit
Collector-Emitter Voltage	$V_{CEO}$	-30	Vdc
Collector-Base Voltage	$V_{CBO}$	-50	Vdc
Emitter-Base Voltage	$V_{EBO}$	-5.0	Vdc
Collector Current – Continuous	$I_C$	-1.0	A
Collector Current – Peak	$I_{CM}$	-2.0	A

### THERMAL CHARACTERISTICS

Characteristic	Symbol	Max	Unit
Total Device Dissipation $T_A = 25^\circ\text{C}$ Derate above $25^\circ\text{C}$	$P_D$ (Note 1)	310	mW
Thermal Resistance, Junction to Ambient	$R_{\theta JA}$ (Note 1)	403	$^\circ\text{C}/\text{W}$
Total Device Dissipation $T_A = 25^\circ\text{C}$ Derate above $25^\circ\text{C}$	$P_D$ (Note 2)	710	mW
Thermal Resistance, Junction to Ambient	$R_{\theta JA}$ (Note 2)	176	$^\circ\text{C}/\text{W}$
Total Device Dissipation (Single Pulse < 10 sec.)	$P_{D\text{single}}$ (Note 3)	575	mW
Junction and Storage Temperature Range	$T_J, T_{stg}$	-55 to +150	$^\circ\text{C}$

Stresses exceeding those listed in the Maximum Ratings table may damage the device. If any of these limits are exceeded, device functionality should not be assumed, damage may occur and reliability may be affected.

1. FR-4 @ Minimum Pad.
2. FR-4 @ 1.0 X 1.0 inch Pad.
3. Refer to Figure 8.



ON Semiconductor®

[www.onsemi.com](http://www.onsemi.com)

**30 VOLTS  
2.0 AMPS  
PNP LOW  $V_{CE(sat)}$  TRANSISTOR  
EQUIVALENT  $R_{DS(on)}$  200 m $\Omega$**

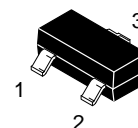
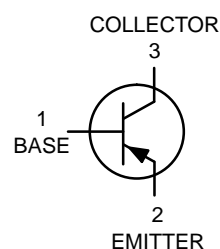

**SOT-23 (TO-236)  
CASE 318  
STYLE 6**

### MARKING DIAGRAM

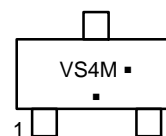

VS4 = Specific Device Code  
M = Date Code\*  
▪ = Pb-Free Package

(Note: Microdot may be in either location)

\*Date Code orientation and/or overbar may vary depending upon manufacturing location.

### ORDERING INFORMATION

Device	Package	Shipping†
NSS30100LT1G, NSV30100LT1G	SOT-23 (Pb-Free)	3000/Tape & Reel

†For information on tape and reel specifications, including part orientation and tape sizes, please refer to our Tape and Reel Packaging Specification Brochure, BRD8011/D.

# NSS30100LT1G

## ELECTRICAL CHARACTERISTICS ( $T_A = 25^\circ\text{C}$ unless otherwise noted)

Characteristic	Symbol	Min	Max	Unit
<b>OFF CHARACTERISTICS</b>				
Collector–Emitter Breakdown Voltage ( $I_C = -10\text{ mA}$ , $I_B = 0$ )	$V_{(BR)CEO}$	-30	-	Vdc
Collector–Base Breakdown Voltage ( $I_C = -0.1\text{ mA}$ , $I_E = 0$ )	$V_{(BR)CBO}$	-50	-	Vdc
Emitter–Base Breakdown Voltage ( $I_E = -0.1\text{ mA}$ , $I_C = 0$ )	$V_{(BR)EBO}$	-5.0	-	Vdc
Collector Cutoff Current ( $V_{CB} = -30\text{ Vdc}$ , $I_E = 0$ )	$I_{CBO}$	-	-0.1	$\mu\text{A}$ dc
Collector–Emitter Cutoff Current ( $V_{CES} = -30\text{ Vdc}$ )	$I_{CES}$	-	-0.1	$\mu\text{A}$ dc
Emitter Cutoff Current ( $V_{EB} = -4.0\text{ Vdc}$ )	$I_{EBO}$	-	-0.1	$\mu\text{A}$ dc
<b>ON CHARACTERISTICS</b>				
DC Current Gain (Note 4) (Figure 1) ( $I_C = -1.0\text{ mA}$ , $V_{CE} = -2.0\text{ V}$ ) ( $I_C = -500\text{ mA}$ , $V_{CE} = -2.0\text{ V}$ ) ( $I_C = -1.0\text{ A}$ , $V_{CE} = -2.0\text{ V}$ ) ( $I_C = 2.0\text{ A}$ , $V_{CE} = -2.0\text{ V}$ )	$h_{FE}$	100 100 80 40	- 300 - -	
Collector–Emitter Saturation Voltage (Note 4) (Figure 3) ( $I_C = -0.5\text{ A}$ , $I_B = -0.05\text{ A}$ ) ( $I_C = -1.0\text{ A}$ , $I_B = 0.1\text{ A}$ ) ( $I_C = -2.0\text{ A}$ , $I_B = -0.2\text{ A}$ )	$V_{CE(sat)}$	- - -	-0.25 -0.30 -0.65	V
Base–Emitter Saturation Voltage (Note 4) (Figure 2) ( $I_C = -1.0\text{ A}$ , $I_B = -0.1\text{ A}$ )	$V_{BE(sat)}$	-	-1.2	V
Base–Emitter Turn–on Voltage (Note 4) ( $I_C = -1.0\text{ A}$ , $V_{CE} = -2.0\text{ V}$ )	$V_{BE(on)}$	-	-1.1	V
Cutoff Frequency ( $I_C = -100\text{ mA}$ , $V_{CE} = -5.0\text{ V}$ , $f = 100\text{ MHz}$ )	$f_T$	100	-	MHz
Output Capacitance ( $f = 1.0\text{ MHz}$ )	Cobo	-	15	pF

Product parametric performance is indicated in the Electrical Characteristics for the listed test conditions, unless otherwise noted. Product performance may not be indicated by the Electrical Characteristics if operated under different conditions.

4. Pulsed Condition: Pulse Width = 300 msec, Duty Cycle  $\leq 2\%$ .

# NSS30100LT1G

## TYPICAL CHARACTERISTICS

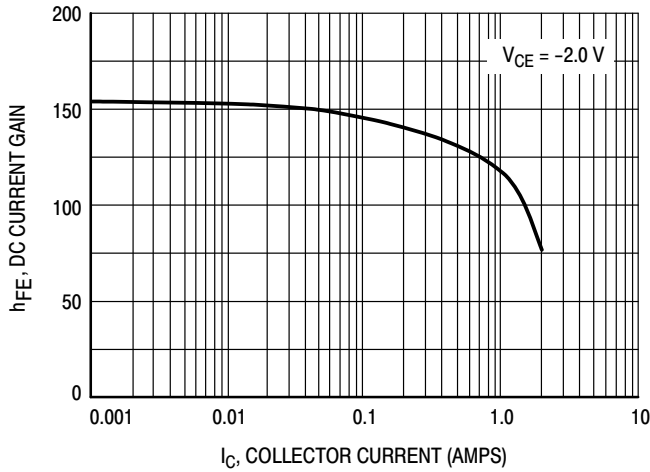

**Figure 1. DC Current Gain versus Collector Current**

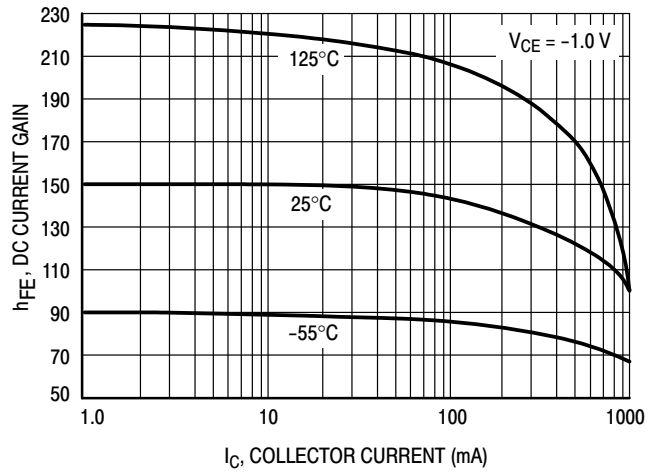

**Figure 2. DC Current Gain versus Collector Current**

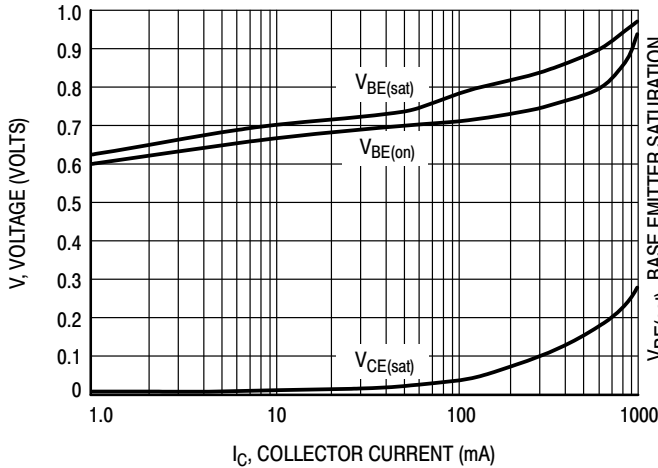

**Figure 3. "On" Voltages**

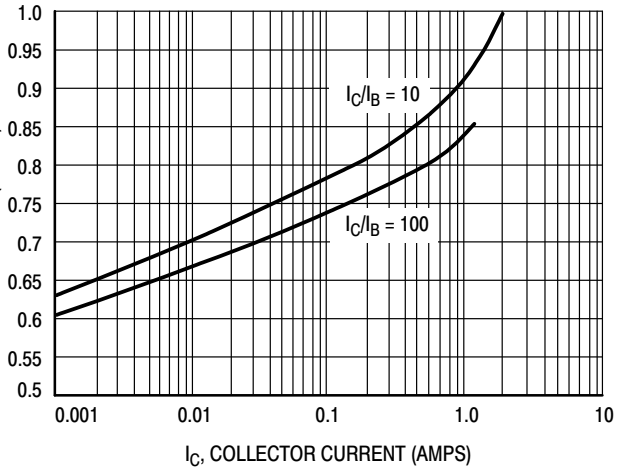

**Figure 4. Base Emitter Saturation Voltage versus Collector Current**

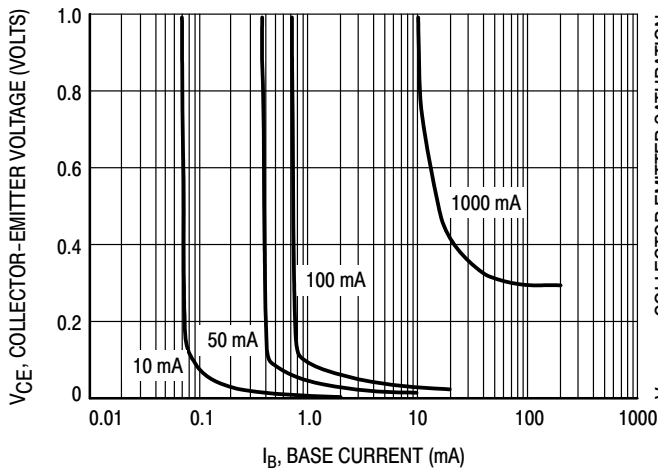

**Figure 5. Collector Emitter Saturation Voltage versus Base Current**

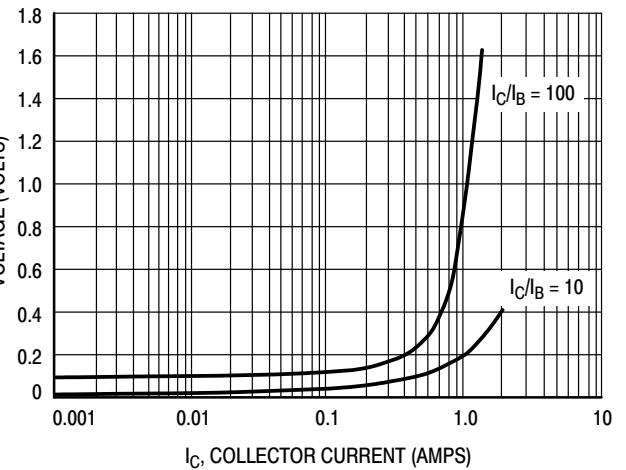

**Figure 6. Collector Emitter Saturation Voltage versus Collector Current**

# NSS30100LT1G

## TYPICAL CHARACTERISTICS

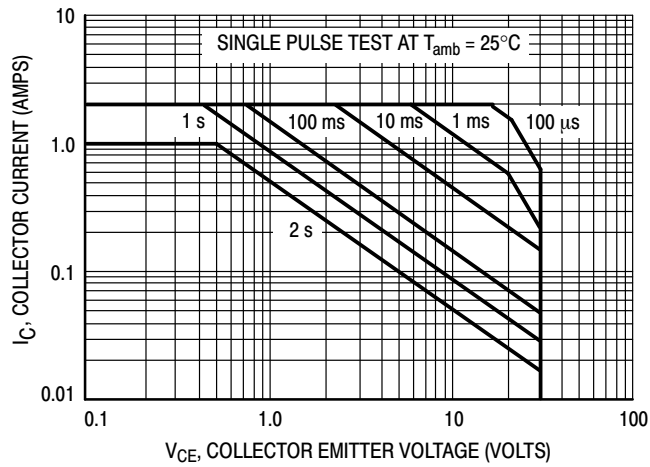

Figure 7. Safe Operating Area

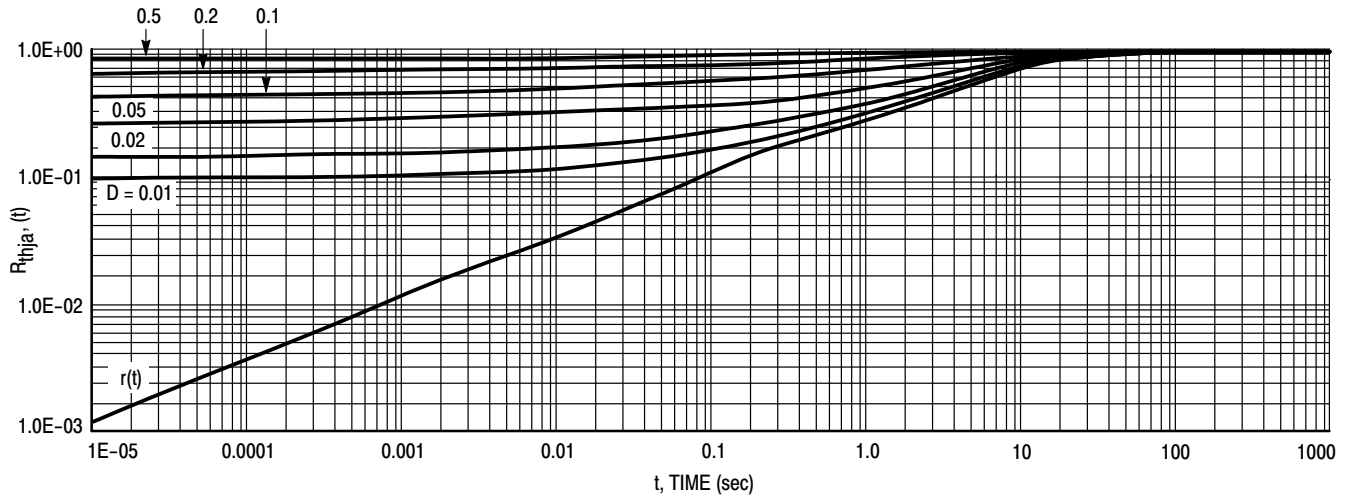
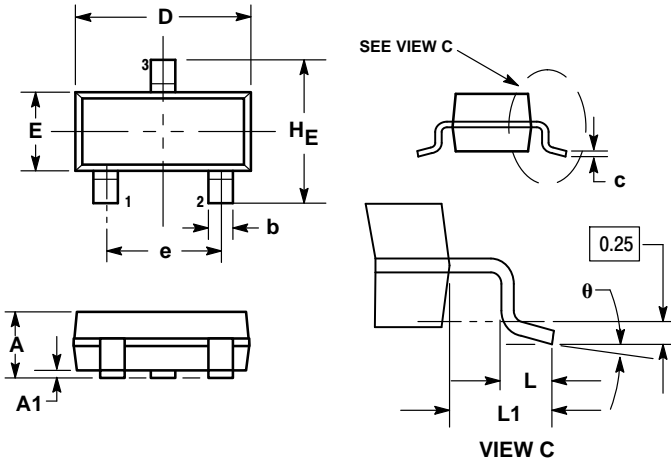

Figure 8. Normalized Thermal Response

# NSS30100LT1G

## PACKAGE DIMENSIONS

SOT-23 (TO-236)  
CASE 318-08  
ISSUE AP



NOTES:

1. DIMENSIONING AND TOLERANCING PER ANSI Y14.5M, 1982.
2. CONTROLLING DIMENSION: INCH.
3. MAXIMUM LEAD THICKNESS INCLUDES LEAD FINISH THICKNESS. MINIMUM LEAD THICKNESS IS THE MINIMUM THICKNESS OF BASE MATERIAL.
4. DIMENSIONS D AND E DO NOT INCLUDE MOLD FLASH, PROTRUSIONS, OR GATE BURRS.

DIM	MILLIMETERS			INCHES		
	MIN	NOM	MAX	MIN	NOM	MAX
A	0.89	1.00	1.11	0.035	0.040	0.044
A1	0.01	0.06	0.10	0.001	0.002	0.004
b	0.37	0.44	0.50	0.015	0.018	0.020
c	0.09	0.13	0.18	0.003	0.005	0.007
D	2.80	2.90	3.04	0.110	0.114	0.120
E	1.20	1.30	1.40	0.047	0.051	0.055
e	1.78	1.90	2.04	0.070	0.075	0.081
L	0.10	0.20	0.30	0.004	0.008	0.012
L1	0.35	0.54	0.69	0.014	0.021	0.029
HE	2.10	2.40	2.64	0.083	0.094	0.104
θ	0°	---	10°	0°	---	10°

STYLE 6:

1. BASE
2. EMITTER
3. COLLECTOR

### SOLDERING FOOTPRINT

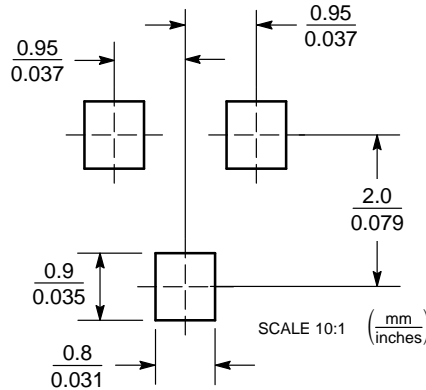

ON Semiconductor and are trademarks of Semiconductor Components Industries, LLC dba ON Semiconductor or its subsidiaries in the United States and/or other countries. ON Semiconductor owns the rights to a number of patents, trademarks, copyrights, trade secrets, and other intellectual property. A listing of ON Semiconductor's product/patent coverage may be accessed at [www.onsemi.com/site/pdf/Patent-Marketing.pdf](http://www.onsemi.com/site/pdf/Patent-Marketing.pdf). ON Semiconductor reserves the right to make changes without further notice to any products herein. ON Semiconductor makes no warranty, representation or guarantee regarding the suitability of its products for any particular purpose, nor does ON Semiconductor assume any liability arising out of the application or use of any product or circuit, and specifically disclaims any and all liability, including without limitation special, consequential or incidental damages. Buyer is responsible for its products and applications using ON Semiconductor products, including compliance with all laws, regulations and safety requirements or standards, regardless of any support or applications information provided by ON Semiconductor. "Typical" parameters which may be provided in ON Semiconductor data sheets and/or specifications can and do vary in different applications and actual performance may vary over time. All operating parameters, including "Typicals" must be validated for each customer application by customer's technical experts. ON Semiconductor does not convey any license under its patent rights nor the rights of others. ON Semiconductor products are not designed, intended, or authorized for use as a critical component in life support systems or any FDA Class 3 medical devices or medical devices with a same or similar classification in a foreign jurisdiction or any devices intended for implantation in the human body. Should Buyer purchase or use ON Semiconductor products for any such unintended or unauthorized application, Buyer shall indemnify and hold ON Semiconductor and its officers, employees, subsidiaries, affiliates, and distributors harmless against all claims, costs, damages, and expenses, and reasonable attorney fees arising out of, directly or indirectly, any claim of personal injury or death associated with such unintended or unauthorized use, even if such claim alleges that ON Semiconductor was negligent regarding the design or manufacture of the part. ON Semiconductor is an Equal Opportunity/Affirmative Action Employer. This literature is subject to all applicable copyright laws and is not for resale in any manner.

### PUBLICATION ORDERING INFORMATION

LITERATURE FULFILLMENT:

Literature Distribution Center for ON Semiconductor  
19521 E. 32nd Pkwy, Aurora, Colorado 80011 USA  
Phone: 303-675-2175 or 800-344-3860 Toll Free USA/Canada  
Fax: 303-675-2176 or 800-344-3867 Toll Free USA/Canada  
Email: [orderlit@onsemi.com](mailto:orderlit@onsemi.com)

N. American Technical Support: 800-282-9855 Toll Free  
USA/Canada  
Europe, Middle East and Africa Technical Support:  
Phone: 421 33 790 2910  
Japan Customer Focus Center  
Phone: 81-3-5817-1050

ON Semiconductor Website: [www.onsemi.com](http://www.onsemi.com)

Order Literature: <http://www.onsemi.com/orderlit>

For additional information, please contact your local Sales Representative