

# CD4078B Types

## CMOS 8-Input NOR/OR Gate

High-Voltage Types (20-Volt Rating)

The RCA-CD4078B NOR/OR Gate provides the system designer with direct implementation of the positive-logic 8-input NOR and OR functions and supplements the existing family of CMOS gates.

The CD4078B types are supplied in 14-lead dual-in-line ceramic packages (D and F suffixes), 14-lead dual-in-line plastic packages (E suffix), 14-lead ceramic flat packages (K suffix), and in chip form (H suffix).

### Features:

- Medium-Speed Operation:  
t<sub>PHL</sub>, t<sub>PLH</sub> = 75 ns (typ.) at V<sub>DD</sub> = 10 V
- Buffered inputs and output
- 5-V, 10-V, and 15-V parametric ratings
- Standardized symmetrical output characteristics
- 100% tested for quiescent current at 20 V
- Maximum input current of 1 μA at 18 V over full package-temperature range: 100 nA at 18 V and 25°C
- Noise margin (over full package-temperature range): 1 V at V<sub>DD</sub> = 5 V  
2 V at V<sub>DD</sub> = 10 V 2.5 V at V<sub>DD</sub> = 15 V
- Meets all requirements of JEDEC Tentative Standard No. 13A, "Standard Specifications for Description of 'B' Series CMOS Devices"

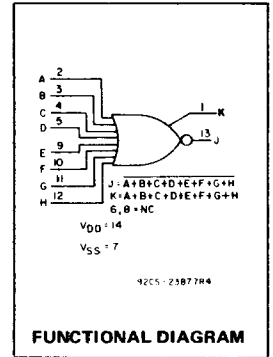

### MAXIMUM RATINGS, Absolute-Maximum Values:

DC SUPPLY-VOLTAGE RANGE, (V <sub>DD</sub> ) (Voltages referenced to V <sub>SS</sub> Terminal)	-0.5 to +20 V
INPUT VOLTAGE RANGE, ALL INPUTS	-0.5 to V <sub>DD</sub> +0.5 V
DC INPUT CURRENT, ANY ONE INPUT	±10 mA
POWER DISSIPATION PER PACKAGE (P <sub>D</sub> ):	
For T <sub>A</sub> = -40 to +60°C (PACKAGE TYPE E)	500 mW
For T <sub>A</sub> = +60 to +85°C (PACKAGE TYPE E)	Derate Linearly at 12 mW/°C to 200 mW
For T <sub>A</sub> = -55 to +100°C (PACKAGE TYPES D, F, K)	500 mW
For T <sub>A</sub> = +100 to +125°C (PACKAGE TYPES D, F, K)	Derate Linearly at 12 mW/°C to 200 mW
DEVICE DISSIPATION PER OUTPUT TRANSISTOR	
FOR T <sub>A</sub> = FULL PACKAGE-TEMPERATURE RANGE (All Package Types)	100 mW
OPERATING-TEMPERATURE RANGE (T <sub>A</sub> ):	
PACKAGE TYPES D, F, K, H	-55 to +125°C
PACKAGE TYPE E	-40 to +85°C
STORAGE TEMPERATURE RANGE (T <sub>stg</sub> )	-65 to +150°C
LEAD TEMPERATURE (DURING SOLDERING):	
At distance 1/16 ± 1/32 inch (1.59 ± 0.79 mm) from case for 10 s max.	+265°C

### RECOMMENDED OPERATING CONDITIONS

For maximum reliability, nominal operating conditions should be selected so that operation is always within the following ranges:

CHARACTERISTIC	Min.	Max.	Units
Supply Voltage Range (For T <sub>A</sub> Full Package Temperature Range)	3	18	V

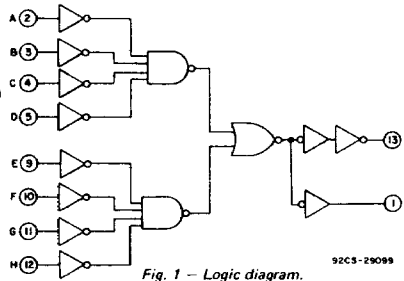

Fig. 1 - Logic diagram.

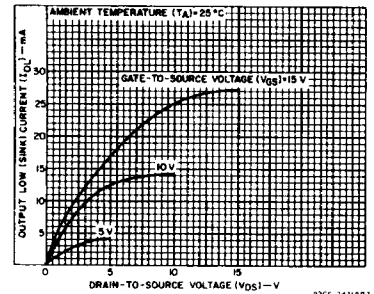

Fig. 2 - Typical output low (sink) current characteristics.

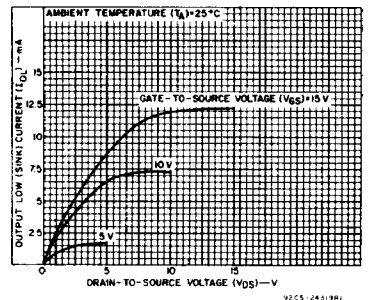

Fig. 3 - Minimum output low (sink) current characteristics.

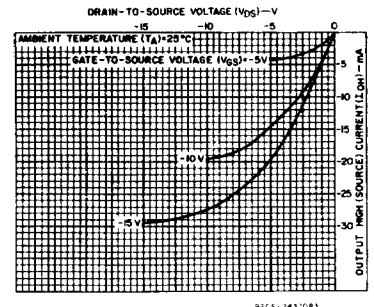

Fig. 4 - Typical output high (source) current characteristics.

### DYNAMIC ELECTRICAL CHARACTERISTICS

At T<sub>A</sub> = 25°C, Input t<sub>r</sub>, t<sub>f</sub> = 20 ns, C<sub>L</sub> = 50 pF, R<sub>L</sub> = 200k Ω

CHARACTERISTIC	TEST CONDITIONS	ALL TYPES LIMITS		UNITS	
		V <sub>DD</sub> VOLTS	TYP.		MAX.
Propagation Delay Time, t <sub>PHL</sub> , t <sub>PLH</sub>		5	150	300	ns
		10	75	150	
		15	55	110	
Transition Time, t <sub>THL</sub> , t <sub>TLH</sub>		5	100	200	ns
		10	50	100	
		15	40	80	
Input Capacitance, C <sub>IN</sub>	Any Input		5	7.5	pF

# CD4078B Types

## STATIC ELECTRICAL CHARACTERISTICS

CHARACTERISTIC	CONDITIONS			LIMITS AT INDICATED TEMPERATURES (°C)							UNITS	
	V <sub>O</sub> (V)	V <sub>IN</sub> (V)	V <sub>DD</sub> (V)					+25				
				-55	-40	+85	+125	Min.	Typ.	Max.		
Quiescent Device Current, I <sub>DD</sub> Max.	-	0,5	5	0.25	0.25	7.5	7.5	-	0.01	0.25	μA	
	-	0,10	10	0.5	0.5	15	15	-	0.01	0.5		
	-	0,15	15	1	1	30	30	-	0.01	1		
	-	0,20	20	5	5	150	150	-	0.02	5		
Output Low (Sink) Current I <sub>OL</sub> Min.	0.4	0,5	5	0.64	0.61	0.42	0.36	0.51	1		mA	
	0.5	0,10	10	1.6	1.5	1.1	0.9	1.3	2.6			
	1.5	0,15	15	4.2	4	2.8	2.4	3.4	6.8			
Output High (Source) Current, I <sub>OH</sub> Min.	4.6	0,5	5	-0.64	-0.61	-0.42	-0.36	-0.51	-1		mA	
	2.5	0,5	5	-2	-1.8	-1.3	-1.15	-1.6	-3.2			
	9.5	0,10	10	-1.6	-1.5	-1.1	-0.9	-1.3	-2.6			
	13.5	0,15	15	-4.2	-4	-2.8	-2.4	-3.4	-6.8			
Output Voltage Low Level, V <sub>OL</sub> Max.	-	0,5	5			0.05			0	0.05	V	
	-	0,10	10			0.05			0	0.05		
	-	0,15	15			0.05			0	0.05		
Output Voltage High Level, V <sub>OH</sub> Min.	-	0,5	5			4.95			4.95	5	V	
	-	0,10	10			9.95			9.95	10		
	-	0,15	15			14.95			14.95	15		
Input Low Voltage, V <sub>IL</sub> Max.	0.5, 4.5	-	5			1.5			-	1.5	V	
	1.9	-	10			3			-	3		
	1.5, 13.5	-	15			4			-	4		
Input High Voltage, V <sub>IH</sub> Min.	0.5, 4.5	-	5			3.5			3.5	-	V	
	1.9	-	10			7			7	-		
	1.5, 13.5	-	15			11			11	-		
Input Current I <sub>IN</sub> Max.			0,18	18	±0.1	±0.1	±1	±1	-	±10 <sup>-5</sup>	±0.1	μA

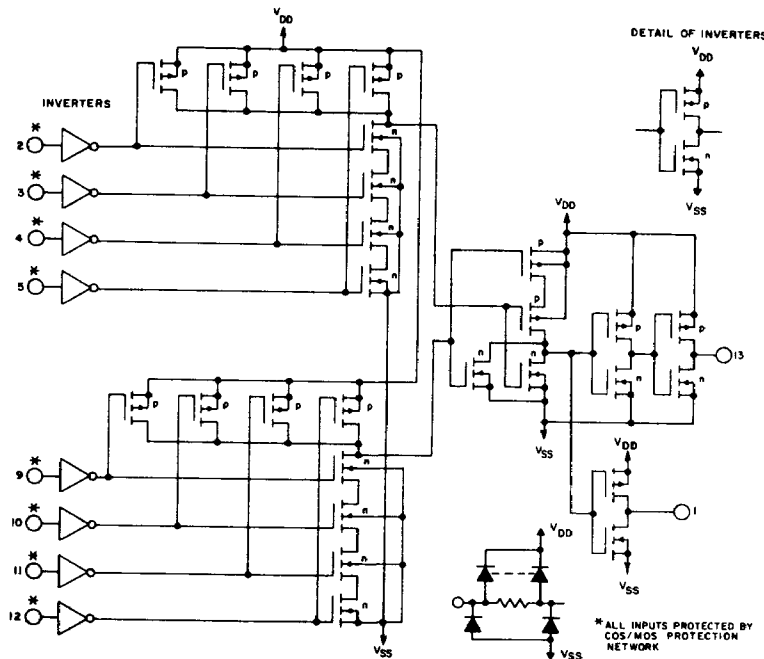

Fig. 8 - Schematic diagram.

92CL-29008

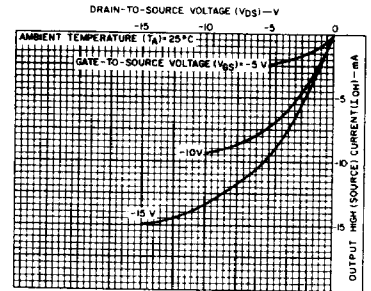

Fig. 5 - Minimum output high (source) current characteristics.

92CS-2432142

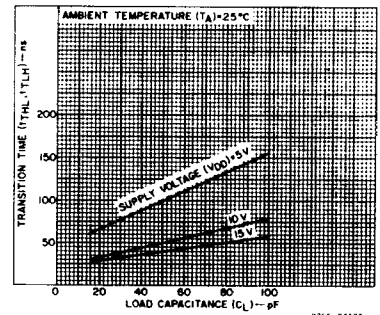

Fig. 6 - Typical transition time as a function of load capacitance.

92CS-24522

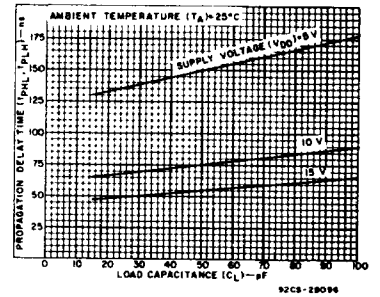

Fig. 7 - Typical propagation delay time as a function of load capacitance.

92CS-28906

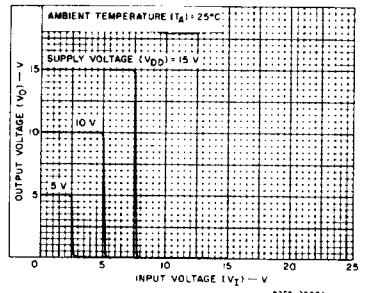

Fig. 9 - Typical voltage transfer characteristics (NOR output).

92CS-28904

# CD4078B Types

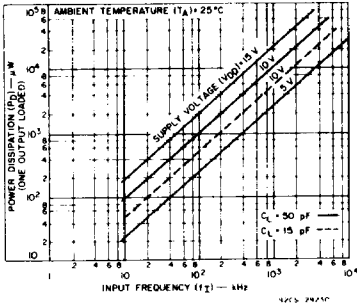

Fig. 10 – Typical dynamic power dissipation as a function of frequency.

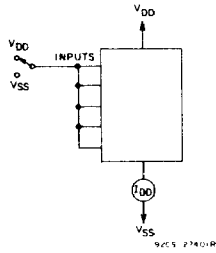

Fig. 11 – Quiescent-device-current test circuit.

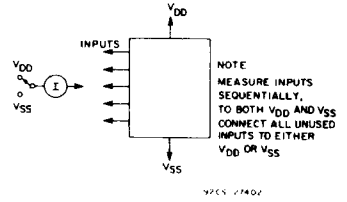

Fig. 12 – Input current test circuit.

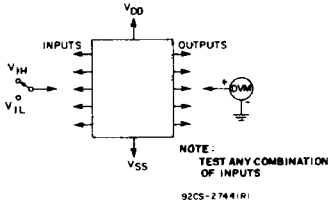

Fig. 13 – Input-voltage test circuit.

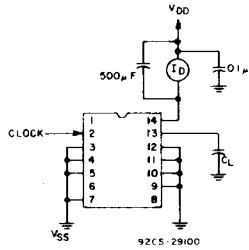
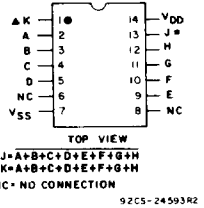
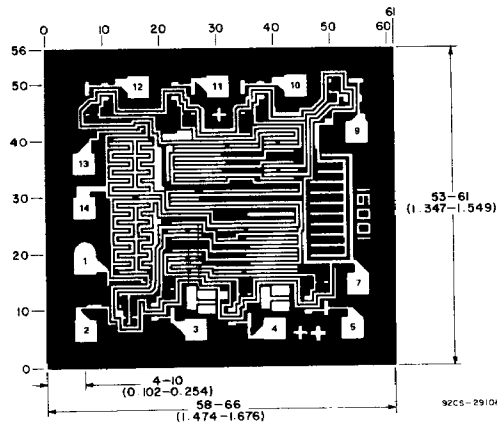

Fig. 14 – Dynamic power dissipation test circuit.



TERMINAL ASSIGNMENT



Dimensions and pad layout for CD4078BH.

Dimensions in parentheses are in millimeters and are derived from the basic inch dimensions as indicated. Grid graduations are in mils ( $10^{-3}$  inch).

The photographs and dimensions of each CMOS chip represent a chip when it is part of the wafer. When the wafer is separated into individual chips, the angle of cleavage may vary with respect to the chip face for different chips. The actual dimensions of the isolated chip, therefore, may differ slightly from the nominal dimensions shown. The user should consider a tolerance of  $-3$  mils to  $+16$  mils applicable to the nominal dimensions shown.