

# LM108, LM108A, LM208, LM208A, LM308, LM308A OPERATIONAL AMPLIFIERS

D2808, OCTOBER 1983 – REVISED FEBRUARY 1991

- Input Offset Current . . . 200 pA Max at 25°C for LM108, LM108A, LM208, LM208A
- Input Bias Current . . . 2 nA Max at 25°C for LM108, LM108A, LM208, LM208A
- Supply Current . . . 600  $\mu$ A Max at 25°C for LM108, LM108A, LM208, LM208A
- Input Offset Voltage . . . 500  $\mu$ V Max at 25°C for LM108A, LM208A, LM308A
- Offset Voltage Temperature Coefficient . . . 5  $\mu$ V/°C Max for LM108A, LM208A, LM308A
- Supply Voltage Range . . .  $\pm 2$  V to  $\pm 18$  V
- Applications:
  - Integrators
  - Transducer Amplifiers
  - Analog Memories
  - Light Meters
- Designed To Be Interchangeable With National LM108 Series and Linear Technology LM108 Series

D, JG, OR P PACKAGE  
(TOP VIEW)

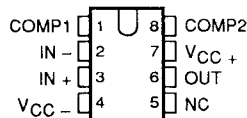

L PACKAGE  
(TOP VIEW)

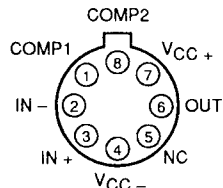

NC – No internal connection  
Pin 4 (L package) is in electrical contact with the case.

symbol

## description

The LM108 series of precision operational amplifiers is particularly well-suited for high-source-impedance applications requiring low input offset and bias currents as well as low power dissipation. Unlike FET input amplifiers, the input offset and bias currents of the LM108 series do not vary significantly with temperature. Advanced design, processing, and testing techniques make this series a superior choice over previous devices. For applications requiring higher performance, see the LT1008 and LT1012.

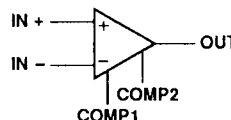

The LM108 and LM108A are characterized for operation over the full military temperature range of  $-55^{\circ}\text{C}$  to  $125^{\circ}\text{C}$ . The LM208 and LM208A are characterized for operation from  $-40^{\circ}\text{C}$  to  $105^{\circ}\text{C}$ . The LM308 and LM308A are characterized for operation from  $0^{\circ}\text{C}$  to  $70^{\circ}\text{C}$ .

## AVAILABLE OPTIONS

$T_A$	$V_{IO}$ max AT 25°C	PACKAGE			
		SMALL OUTLINE (D)	CERAMIC DIP (JG)	METAL CAN (L)	PLASTIC DIP (P)
0°C to 70°C	0.5 mV	LM308AD	————	————	LM308AP
	7.5 mV	LM308D	————	————	LM308P
$-40^{\circ}\text{C}$ to $105^{\circ}\text{C}$	0.5 mV	LM208AD	————	————	LM208AP
	2 mV	LM208D	————	————	LM208P
$-55^{\circ}\text{C}$ to $125^{\circ}\text{C}$	0.5 mV	LM108AD	LM108AJG	LM108AL	LM108AP
	2 mV	LM108D	LM108JG	LM108L	LM108P

The D package is available taped and reeled. Add the suffix R to the device type (e.g., LM308ADR).

PRODUCTION DATA documents contain information current as of publication date. Products conform to specifications per the terms of Texas Instruments standard warranty. Production processing does not necessarily include testing of all parameters.

**TEXAS  
INSTRUMENTS**

POST OFFICE BOX 655303 • DALLAS, TEXAS 75265

Copyright © 1991, Texas Instruments Incorporated

On products compliant to MIL-STD-883, Class B, all parameters are tested unless otherwise noted. On all other products, production processing does not necessarily include testing of all parameters.

# LM108, LM108A, LM208, LM208A, LM308, LM308A OPERATIONAL AMPLIFIERS

## schematic

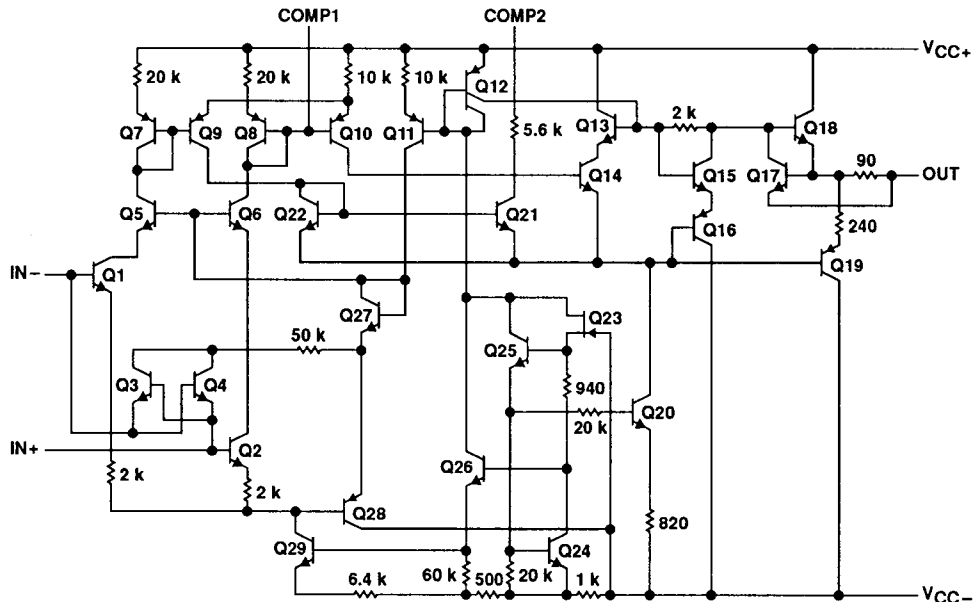

All resistor values shown are nominal and in ohms.

### absolute maximum ratings over operating free-air temperature range (unless otherwise noted)

Supply voltage, $V_{CC+}$ (see Note 1): LM108, LM108A, LM208, LM208A	20 V
LM308, LM308A	18 V
Supply voltage, $V_{CC-}$ (see Note 1): LM108, LM108A, LM208, LM208A	-20 V
LM308, LM308A	-18 V
Input voltage range, $V_I$ (see Note 2)	$\pm 15$ V
Differential input current (see Notes 3 and 4)	$\pm 10$ mA
Duration of output short-circuit at (or below) 25°C (see Note 5)	unlimited
Operating free-air temperature range, $T_A$ : LM108, LM108A	-55°C to 125°C
LM208, LM208A	-40°C to 105°C
LM308, LM308A	0°C to 70°C
Storage temperature range	-65°C to 150°C
Lead temperature 1,6 mm (1/16 inch) from case for 10 seconds: D or P package	260°C
Lead temperature 1,6 mm (1/16 inch) from case for 10 seconds: JG or L package	300°C

- NOTES: 1. All voltage values, unless otherwise noted, are with respect to the midpoint between  $V_{CC+}$  and  $V_{CC-}$ .
2. The magnitude of the input voltage must never exceed the magnitude of the supply voltage or 15 V, whichever is less.
3. The inputs are shunted with two opposite-facing base-emitter diodes for over-voltage protection. Therefore, excessive current will flow if a differential input voltage in excess of approximately 1 V is applied between the inputs unless some limiting resistance is used.
4. Differential voltages are at the noninverting input terminal with respect to the inverting input terminal.
5. The output may be shorted to ground or either power supply.

# LM108, LM108A, LM208, LM208A, LM308, LM308A OPERATIONAL AMPLIFIERS

## recommended operating conditions

	LM108, LM108A			LM208, LM208A			LM308, LM308A			UNIT
	MIN	NOM	MAX	MIN	NOM	MAX	MIN	NOM	MAX	
Supply voltage, $V_{CC+}$	5		20	5		20	5		20	V
Supply voltage, $V_{CC-}$	-5		-20	-5		-20	-5		-20	V
Operating free-air temperature, $T_A$	-55		125	-40		85	0		70	°C

## electrical characteristics at specified free-air temperature, $V_{CC\pm} = \pm 5\text{ V to } \pm 20\text{ V}$ (unless otherwise noted)

PARAMETER	TEST CONDITIONS	$T_A^\dagger$	LM108A, LM208A			LM108, LM208			UNIT
			MIN	TYP	MAX	MIN	TYP	MAX	
$V_{IO}$ Input offset voltage	$R_S = 50\ \Omega$	25°C		0.3	0.5		0.7	2	mV
		Full range			1			3	
$\alpha_{VIO}$ Temperature coefficient of input offset voltage		Full range		1	5*		3	15*	$\mu\text{V}/^\circ\text{C}$
$I_{IO}$ Input offset current		25°C		0.05	0.2		0.05	0.2	nA
		Full range			0.4			0.4	
$\alpha_{IIO}$ Temperature coefficient of input offset current		Full range		0.5	2.5*		0.5	2.5*	$\text{pA}/^\circ\text{C}$
$I_B$ Input bias current		25°C		0.5	2		0.5	2	nA
		Full range			3			3	
$V_{ICR}$ Common-mode input voltage range	$V_{CC\pm} = \pm 15\text{ V}$	Full range		$\pm 13.5$		$\pm 13.5$			V
$V_{OM}$ Maximum peak output voltage swing	$V_{CC\pm} = \pm 15\text{ V}$ , $R_L = 10\text{ k}\Omega$	Full range		$\pm 13$		$\pm 13$			V
$A_{VD}$ Large-signal differential voltage amplification	$V_{CC\pm} = \pm 15\text{ V}$ , $V_O = \pm 10\text{ V}$ , $R_L \geq 10\text{ k}\Omega$	25°C		80	300		50	300	V/mV
		Full range		40			25		
$r_i$ Input resistance		25°C		30*	70		30*	70	$\text{M}\Omega$
CMRR Common-mode rejection ratio		Full range		96		85			dB
$k_{SVR}$ Supply-voltage rejection ratio ( $\Delta V_{CC\pm} / \Delta V_{IO}$ )		Full range		96		80			dB
$I_{CC}$ Supply current		25°C		0.3	0.6		0.3	0.6	mA
		105°C, 125°C			0.4			0.4	

\*On products compliant to MIL-STD-883, Class B, these parameters are not production tested.

†Full range is  $-40^\circ\text{C}$  to  $105^\circ\text{C}$  for the LM208 and LM208A and  $-55^\circ\text{C}$  to  $125^\circ\text{C}$  for the LM108 and LM108A.

# LM308, LM308A OPERATIONAL AMPLIFIERS

electrical characteristics at specified free-air temperature,  $V_{CC\pm} = \pm 5\text{ V}$  to  $\pm 15\text{ V}$  (unless otherwise noted)

PARAMETER	TEST CONDITIONS	$T_A^{\dagger}$	LM308A			LM308			UNIT
			MIN	TYP	MAX	MIN	TYP	MAX	
$V_{IO}$	Input offset voltage	$R_S = 50\ \Omega$	25°C	0.3	0.5	2	7.5	mV	
			Full range	0.73			10		
$\alpha_{VIO}$	Temperature coefficient of input offset voltage		Full range	2	5	6	30	$\mu\text{V}/^{\circ}\text{C}$	
$I_{IO}$	Input offset current		25°C	0.2	1	0.2	1	nA	
			Full range	1.5			1.5		
$\alpha_{IIO}$	Temperature coefficient of input offset current		Full range	2	10	2	10	$\mu\text{A}/^{\circ}\text{C}$	
$I_{IB}$	Input bias current		25°C	1.5	7	1.5	7	nA	
			Full range	10			10		
$V_{ICR}$	Common-mode input voltage range	$V_{CC\pm} = \pm 15\text{ V}$	Full range	$\pm 14$		$\pm 14$		V	
$V_{OM}$	Maximum peak output voltage swing	$V_{CC\pm} = \pm 15\text{ V}$ , $R_L = 10\text{ k}\Omega$	Full range	$\pm 13$		$\pm 13$		V	
$A_{VD}$	Large-signal differential voltage amplification	$V_{CC\pm} = \pm 15\text{ V}$ , $V_O = \pm 10\text{ V}$ , $R_L \geq 10\text{ k}\Omega$	25°C	80	300	25	300	V/mV	
			Full range	60			15		
$r_i$	Input resistance		25°C	10	40	10	40	M $\Omega$	
CMRR	Common-mode rejection ratio		Full range	96		80		dB	
$k_{SVR}$	Supply-voltage rejection ratio ( $\Delta V_{CC\pm} / \Delta V_{IO}$ )		Full range	96		80		dB	
$I_{CC}$	Supply current		25°C	0.3	0.8	0.3	0.8	mA	

<sup>†</sup>Full range is 0°C to 70°C.

TYPICAL CHARACTERISTICS†

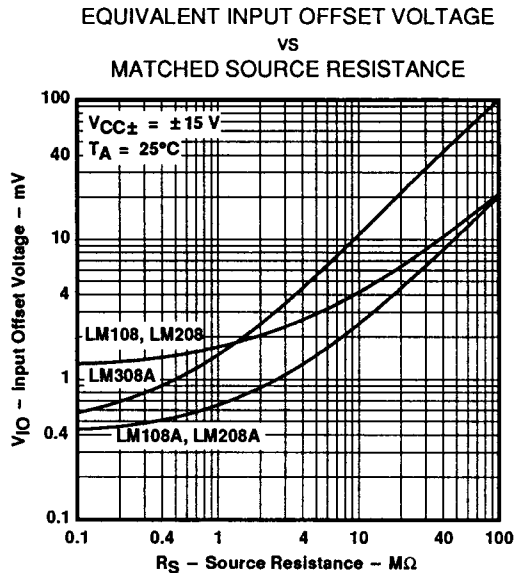

Figure 1

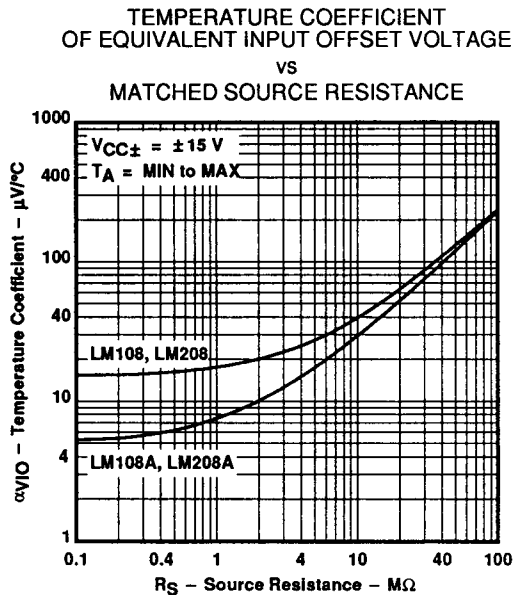

Figure 2

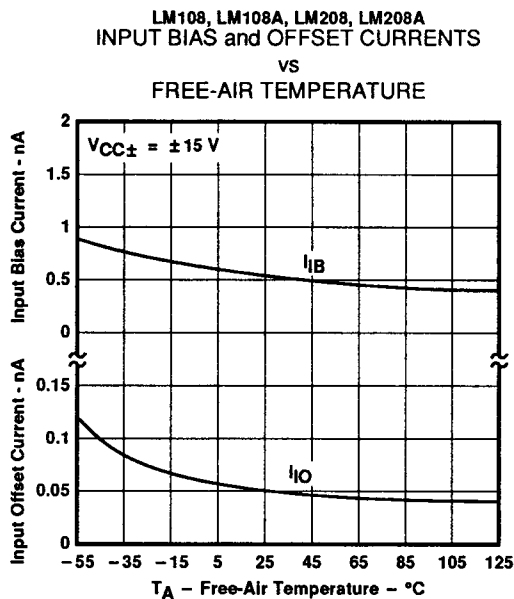

Figure 3

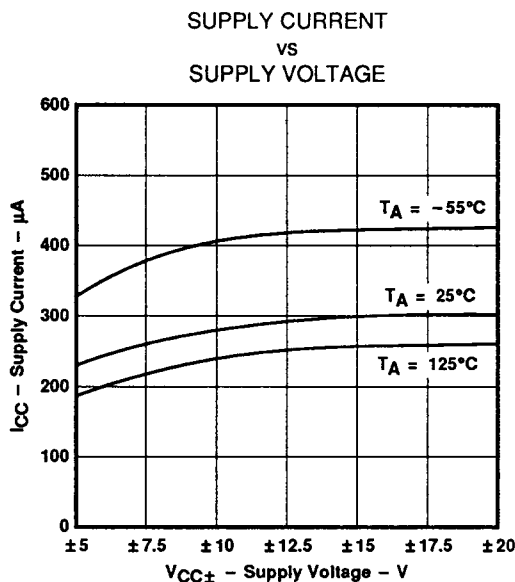

Figure 4

†Data at high and low temperatures are applicable only within the rated operating free-air temperature ranges of the various devices.

TYPICAL CHARACTERISTICS†

MAXIMUM PEAK OUTPUT VOLTAGE SWING  
VS  
FREQUENCY

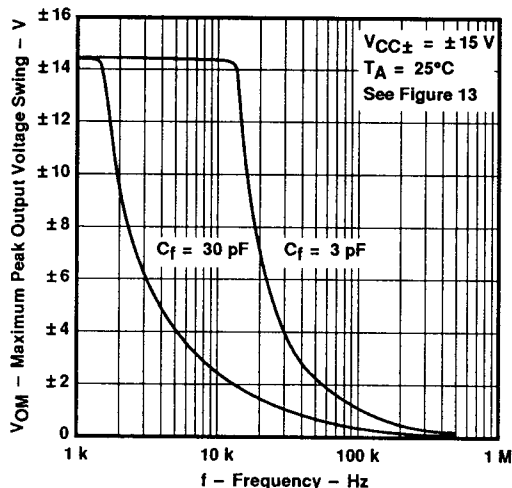

Figure 5

MAXIMUM PEAK OUTPUT VOLTAGE SWING  
VS  
OUTPUT CURRENT

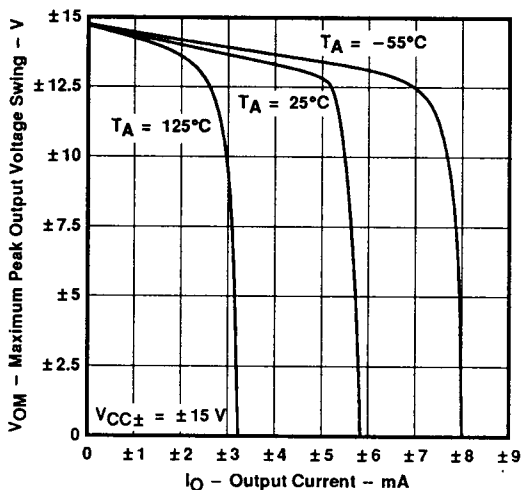

Figure 6

DIFFERENTIAL VOLTAGE AMPLIFICATION  
VS  
SUPPLY VOLTAGE

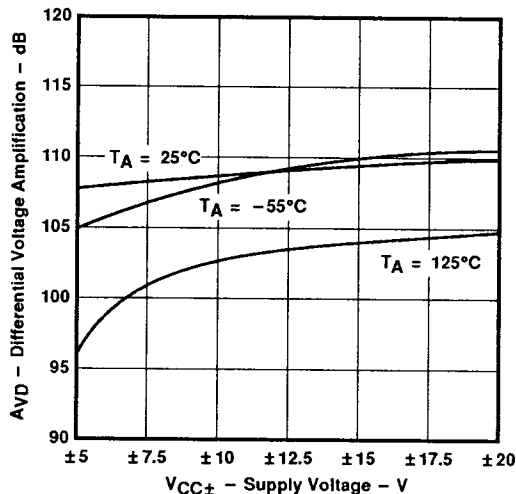

Figure 7

DIFFERENTIAL VOLTAGE AMPLIFICATION  
and PHASE DELAY  
VS  
FREQUENCY

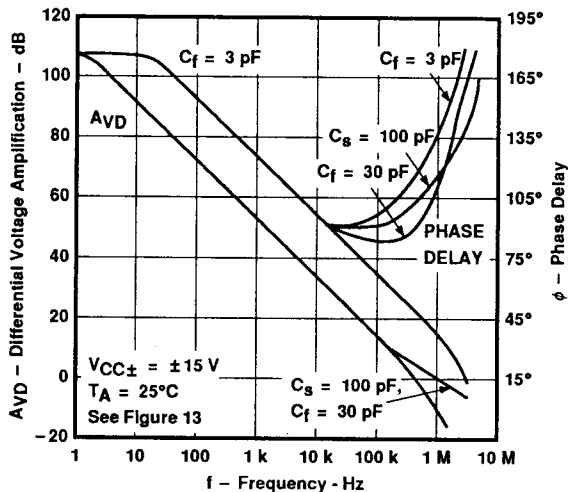

Figure 8

†Data at high and low temperatures are applicable only within the rated operating free-air temperature ranges of the various devices.

TYPICAL CHARACTERISTICS

SUPPLY VOLTAGE REJECTION RATIO  
VS  
FREQUENCY

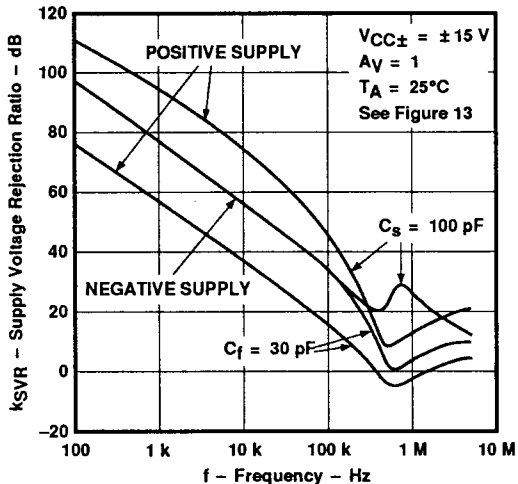

Figure 9

CLOSED-LOOP OUTPUT IMPEDANCE  
VS  
FREQUENCY

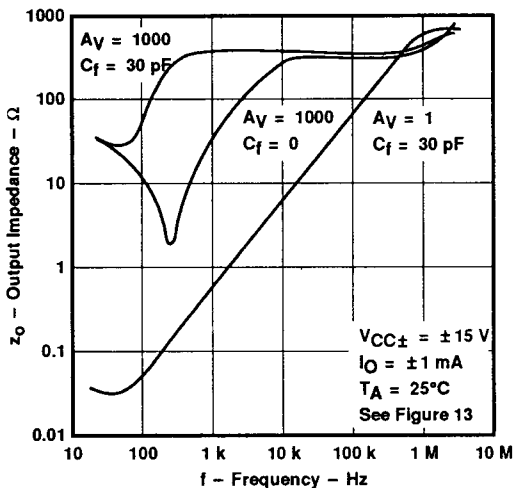

Figure 10

EQUIVALENT INPUT NOISE VOLTAGE  
VS  
FREQUENCY

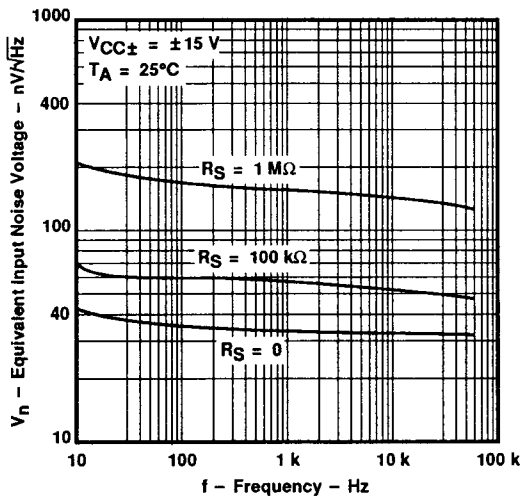

Figure 11

VOLTAGE FOLLOWER  
PULSE RESPONSE

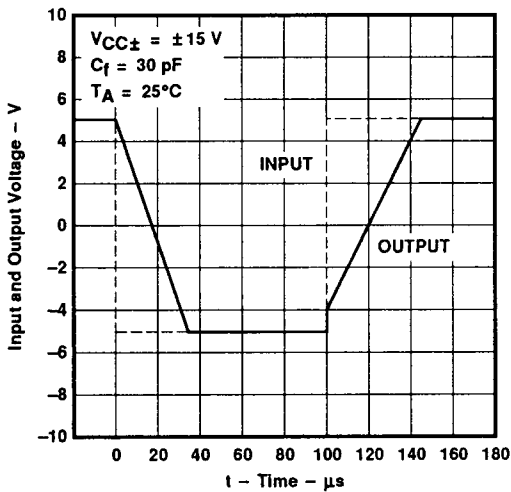
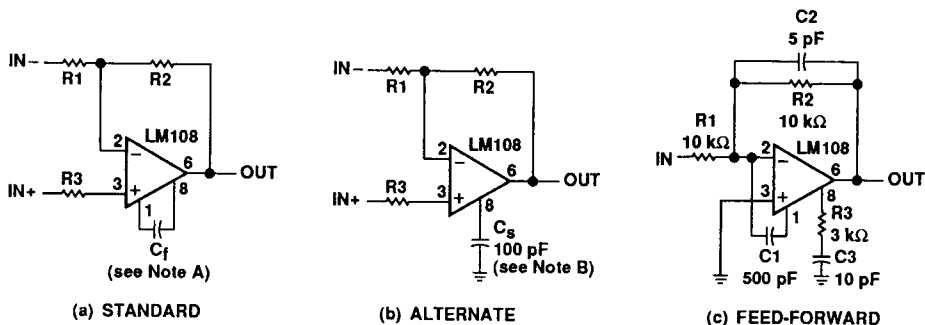

Figure 12

## APPLICATION INFORMATION

### frequency compensation

Figure 13 shows the frequency compensation circuits for standard compensation, alternate compensation, and feed-forward compensation. The alternate compensation circuit improves supply voltage rejection by a factor of ten.



NOTES: A.  $C_f \geq R_1 C_O / (R_1 + R_2)$ ,  $C_O = 30 \text{ pF}$ , bandwidth and slew rate are proportional to  $1/C_f$ .  
B. Bandwidth and slew rate are proportional to  $1/C_s$ .

Figure 13. Frequency Compensation Circuits

### input guarding

Input guarding is used to reduce surface leakage (see Figure 14). Both sides of the board must be guarded. Bulk leakage reduction is less than surface leakage reduction and depends on the guard-ring width. The guard ring is connected to a low-impedance point at the same potential as the sensitive input leads. Connections for various op-amp configurations are shown in Figure 15.

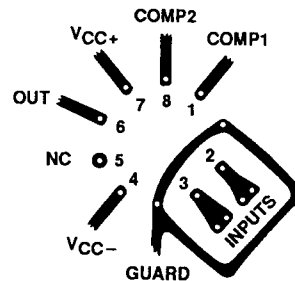

Figure 14. Input Guarding

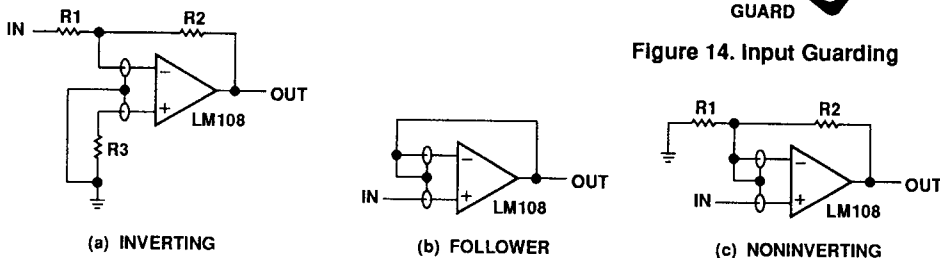

Figure 15. Guard Ring Connections for Various Op Amp Configurations



APPLICATION INFORMATION

input protection

Current is limited by R2 even when the input is connected to a voltage source outside the common-mode range [see Figure 16(a)]. If one supply reverses, current is controlled by R1. These resistors do not affect normal operation. The input resistor controls the current when the input exceeds the supply voltages, when the power for the op amp is turned off, or when the output is shorted [see Figure 16(b)].

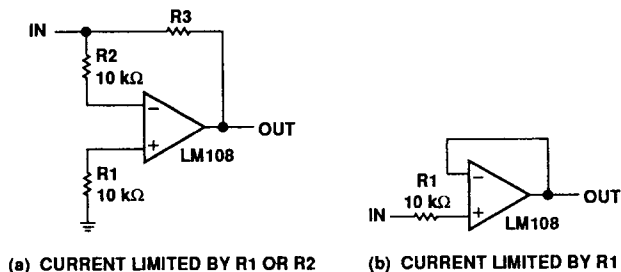
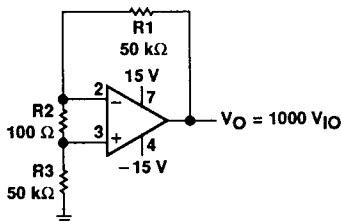

Figure 16. Input Protection

input offset voltage testing

The test circuit for input offset voltage is shown in Figure 17. This circuit is also used as the burn-in configuration with supply voltages equal to  $\pm 20$  V,  $R1 = R3 = 10$  k $\Omega$ ,  $R2 = 200$   $\Omega$ ,  $AV = 100$ .



NOTE A: Resistors must have low thermoelectric potential.

Figure 17. Test Circuit for Input Offset Voltage

APPLICATION INFORMATION

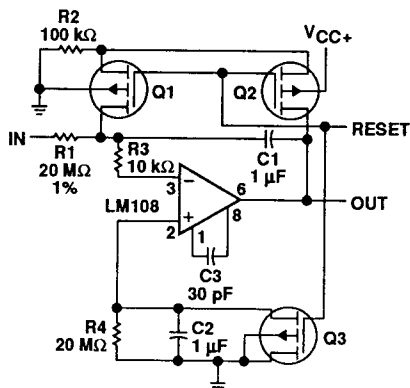

NOTE A: Q1 and Q3 should not have internal gate-protection diodes.

Figure 18. Low-Drift Integrator With Reset

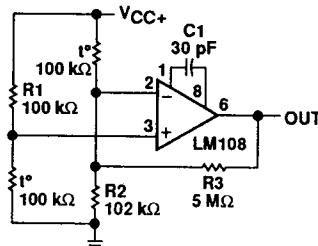

NOTE A:  $R1 = R2R3/(R2 + R3)$ .

Figure 19. Amplifier for Bridge Transducers

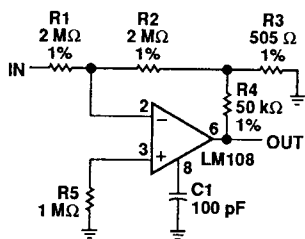

NOTE A:  $R2 > R1$ ,  $R2 \gg R3$ ,  
 $A_v = R2(R3 + R4)/R1R3$ .

Figure 20. Inverting Amplifier With High Input Resistance

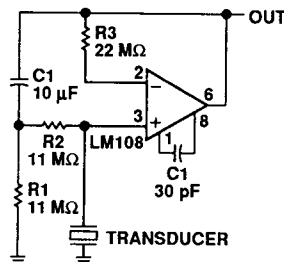
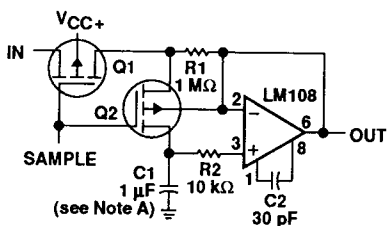
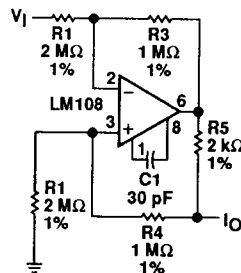

Figure 21. Amplifier for Piezoelectric Transducers



NOTES: A Teflon, polyethylene, or polycarbonate dielectric capacitor.  
B. Worst-case drift is less than 2.5 mV/s.

Figure 22. Sample-and-Hold Amplifier



NOTE A:  $I_O = (R3)V_I/R1R5$   
 $R3 = R4 + R5$   
 $R1 = R2$

Figure 23. Bilateral Current Source

APPLICATION INFORMATION

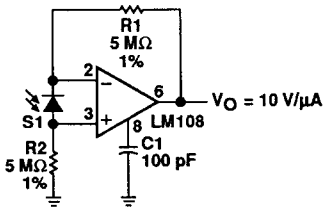
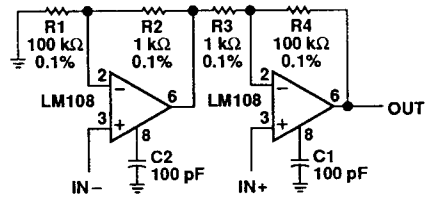
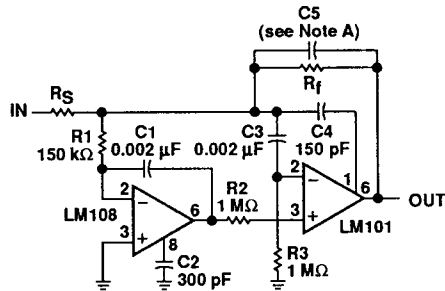

Figure 24. Amplifier for Photodiode Sensor



NOTE A:  $R_1 = R_4$ ,  $R_2 = R_3$ ,  $A_V = 1 + R_1/R_2$

Figure 25. Differential-Input Instrumentation Amplifier



- NOTES: A.  $C_5 = 6 \times 10^{-9}/R_f$   
 B. Power bandwidth = 250 kHz  
 C. Small-signal bandwidth = 3.5 MHz  
 D. Slew Rate = 10 V/μs  
 E. The LM101 increases speed, raises high- and low-frequency gain, increases output drive capability, and eliminates thermal feedback.

Figure 26. Fast Summing Amplifier