

CMOS 21-Stage Counter

High-Voltage Types (20-Volt Rating)

■ CD4045B is a timing circuit consisting of 21 counter stages, two output-shaping flip-flops, two inverter output drivers, and input inverters for use in a crystal oscillator. The CD4045B configuration provides 21 flip-flop counting stages, and two flip-flops for shaping the output waveform for a 3.125% duty cycle. Push-pull operation is provided by the inverter output drivers.

The first inverter is intended for use as a crystal oscillator/amplifier. However, it may be used as a normal logic inverter if desired. A crystal oscillator circuit can be made less sensitive to voltage-supply variations by the use of source resistors. In this device, the sources of the p and n transistors have been brought out to package terminals. If external resistors are not required, the sources must be shorted to their respective substrates (S_p to V_{DD} , S_n to V_{SS}). See Fig. 1. The first inverter in conjunction with an outboard inverter, such as 1/6 CD4069, and R_X , C_X , and R_S can also be used to construct an RC oscillator. The following data is supplied as a guide in the selection of values for R_X , R_S , and C_X used in Fig. 11:

1. R_X max = 10 M Ω with R_S = 10 M Ω and C_X = 50 pF
2. C_X max = 25 μ F with R_S = 560 k Ω and R_X = 50 k Ω

The CD4045B types are supplied in 16-lead dual-in-line ceramic packages (D and F suffixes), 16-lead dual-in-line plastic packages (E suffix), and in chip form (H suffix).

Applications:

- Digital equipment in which ultra-low dissipation and/or operation using a battery source is required.
- Accurate timing from a crystal oscillator for timing applications such as wall clocks, table clocks, automobile clocks, and digital timing references in any circuit requiring accurately timed outputs at various intervals in the counting sequence.
- Driving miniature synchronous motors, stepping motors, or external bipolar transistors in push-pull fashion.

Features:

- Very low operating dissipation <1 mW (typ.) @ V_{DD} = 5 V, $f\phi$ = 1 MHz
- Output drivers with sink or source capability 7 mA (typ.) @ V_{DD} = 5 V
- Medium speed (typ.) $f\phi$ = 25 MHz @ V_{DD} = 10 V
- 100% tested for quiescent current at 20 V
- 5-V, 10-V, and 15-V parametric ratings
- Meets all requirements of JEDEC Tentative Standard No. 13B, Standard Specifications for Description of 'B' Series CMOS Devices"

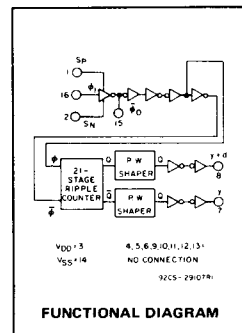

MAXIMUM RATINGS, Absolute-Maximum Values:

DC SUPPLY-VOLTAGE RANGE, (V_{DD})	-0.5V to +20V
Voltages referenced to V_{SS} Terminal	
INPUT VOLTAGE RANGE, ALL INPUTS	-0.5V to V_{DD} + 0.5V
DC INPUT CURRENT, ANY ONE INPUT	\pm 10mA
POWER DISSIPATION PER PACKAGE (P_D):	
For T_A = -55°C to +100°C	500mW
For T_A = +100°C to +125°C	Derate Linearly at 12mW/°C to 200mW
DEVICE DISSIPATION PER OUTPUT TRANSISTOR	
FOR T_A = FULL PACKAGE-TEMPERATURE RANGE (All Package Types)	100mW
OPERATING-TEMPERATURE RANGE (T_A)	-55°C to +125°C
STORAGE TEMPERATURE RANGE (T_{stg})	-65°C to +150°C
LEAD TEMPERATURE (DURING SOLDERING):	
At distance 1/16 \pm 1/32 inch (1.59 \pm 0.79mm) from case for 10s max	+265°C

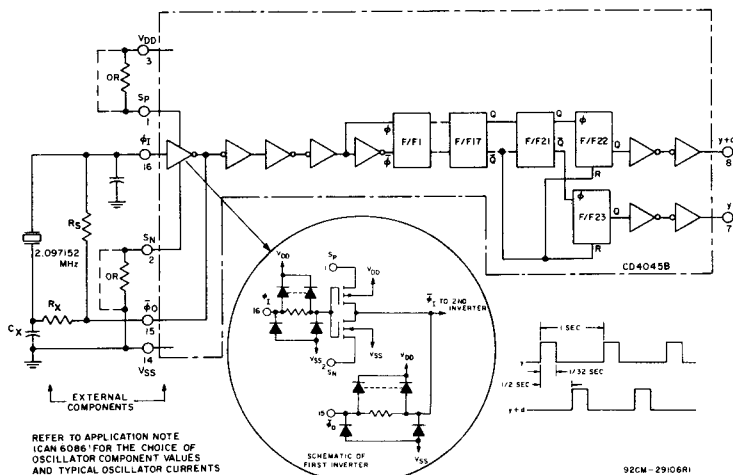

Fig. 1 - CD4045B and outboard components in a typical 21-stage counter application.

CD4045B Types

STATIC ELECTRICAL CHARACTERISTICS

CHARACTERISTIC	CONDITIONS			LIMITS AT INDICATED TEMPERATURES (°C)							UNIT
	V _O (V)	V _{IN} (V)	V _{DD} (V)	-55	-40	+85	+125	+25			
								Min.	Typ.	Max.	
Quiescent Device Current, I _{DD} Max.	-	0,5	5	5	5	150	150	-	0.04	5	μA
	-	0,10	10	10	10	300	300	-	0.04	10	
	-	0,15	15	20	20	600	600	-	0.04	20	
	-	0,20	20	100	100	3000	3000	-	0.08	100	
Output Low (Sink) Current I _{OL} Min.	0.4	0,5	5	4.5	4.3	2.9	2.5	3.6	7	-	mA
	0.5	0,10	10	11.2	10.5	7.7	6.3	9.1	18	-	
	1.5	0,15	15	29.4	28	19.6	16.8	23.8	47	-	
Output High (Source) Current, I _{OH} Min.	4.6	0,5	5	-4.5	-4.3	-2.9	-2.5	-3.6	-7	-	mA
	9.5	0,10	10	-11.2	-10.5	-7.7	-6.3	-9.1	-18	-	
	13.5	0,15	15	-29.4	-28	-19.6	-16.8	-23.8	-47	-	
Pin 15 Output Low and High Current, I _{OL} , I _{OH}	0.4,4.6	0,5	5	-				±0.1	±0.18	-	mA
	0.5,9.5	0,10	10	-				±0.2	±0.3	-	
Output Voltage: Low-Level, V _{OL} Max.	-	0,5	5	0.05				-	-	0.05	V
	-	0,10	10	0.05				-	-	0.05	
Output Voltage: High-Level, V _{OH} Min.	-	0,5	5	4.95				4.95	5	-	V
	-	0,10	10	9.95				9.95	10	-	
	-	0,15	15	14.95				14.95	15	-	
Input Low Voltage, V _{IL} Max.	0.5,4.5	-	5	1.5				-	-	1.5	V
	1.9	-	10	3				-	-	3	
Input High Voltage, V _{IH} Min.	1.5,13.5	-	15	4				-	-	4	V
	0.5,4.5	-	5	3.5				3.5	-	-	
	1.9	-	10	7				7	-	-	
Input Current I _{IN} Max.	1.5,13.5	-	15	11				11	-	-	μA
	-	0,18	18	±0.1	±0.1	±1	±1	-	±10 ⁻⁵	±0.1	

RECOMMENDED OPERATING CONDITIONS

For maximum reliability, nominal operating conditions should be selected so that operation is always within the following ranges

CHARACTERISTIC	V _{DD} (V)	LIMITS		UNITS
		Min.	Max.	
Supply-Voltage Range (For T _A = Full Package-Temperature Range)	-	3	18	V
Minimum Input-Pulse Width, t _W	5	-	100	ns
	10	-	50	
	15	-	40	
Maximum Input-Pulse Frequency, f _φ (External Pulse Source)	5	5	-	MHz
	10	12	-	
	15	15	-	

CD4045B Types

DYNAMIC ELECTRICAL CHARACTERISTICS at $T_A = 25^\circ\text{C}$; Input $t_r, t_f = 20\text{ ns}$, $C_L = 50\text{ pF}$, $R_L = 200\text{ k}\Omega$

CHARACTERISTIC	TEST CONDITIONS	V_{DD} V	LIMITS			UNITS
			Min.	Typ.	Max.	
Propagation Delay Time: ϕ_1 to y or y+d out t_{PHL}, t_{PLH}		5	-	2.2	5.5	μs
		10	-	0.9	2.7	
		15	-	0.65	2	
Transition Time: t_{THL}, t_{TLH}		5	-	25	50	ns
		10	-	13	25	
		15	-	10	20	
Minimum Input-Pulse Width t_W		5	-	50	100	ns
		10	-	25	50	
		15	-	20	40	
Input-Pulse Rise or Fall Time: $t_r\phi, t_f\phi$		5	-	-	500	μs
		10	-	-	500	
		15	-	-	500	
Maximum Input-Pulse Frequency: (External Pulse Source) f_ϕ		5	5	10	-	MHz
		10	12	25	-	
		15	15	30	-	
Input Capacitance, C_{IN}	Any Input		-	5	7.5	pF
Variation of Output Frequency (Unit-to-Unit)	f = 5 MHz	5	-	0.05	-	%
		10	-	0.03	-	
		15	-	0.1	-	
RC Oscillator Operation						
Maximum Oscillator Frequency (See Fig. 11) f_{osc}	$R_X = 50\text{ k}\Omega$, $R_S = 560\text{ k}\Omega$, $C_X = 50\text{ pF}$	5	45	60	75	kHz
		10	45	60	75	
		15	45	60	75	

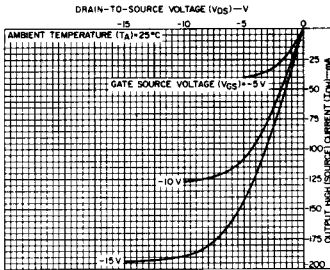

Fig. 4 - Typical output high (source) current characteristics.

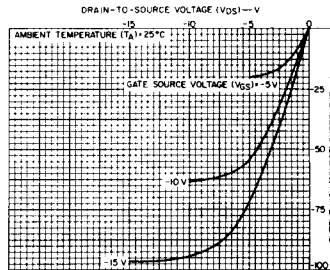

Fig. 5 - Minimum output high (source) characteristics.

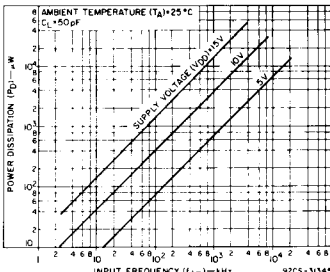

Fig. 7 - Typical power dissipation as a function of input frequency (21 counting stages).

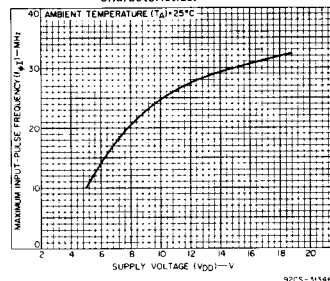

Fig. 8 - Typical maximum input-pulse frequency as a function of supply voltage.

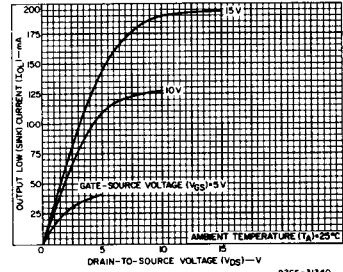

Fig. 2 - Typical output low (sink) current characteristics.

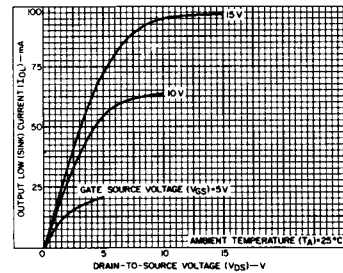

Fig. 3 - Minimum output low (sink) current characteristics.

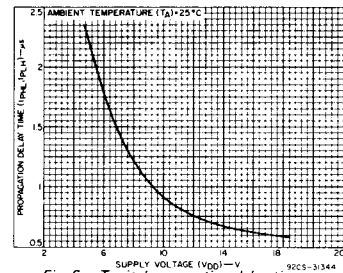

Fig. 6 - Typical propagation delay time as a function of supply voltage (ϕ_1 to y or y+d out vs. V_{DD}).

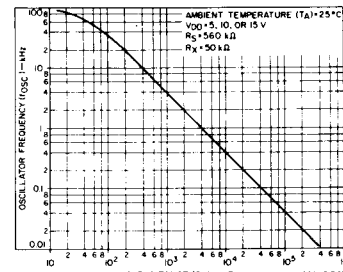

Fig. 9 - Typical RC oscillator frequency as a function of capacitance (C_X). See Fig. 11.

CD4045B Types

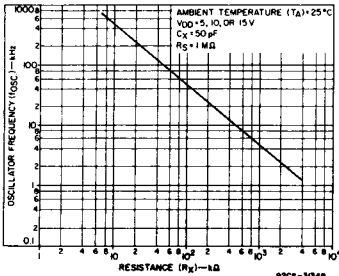

Fig. 10 – Typical RC oscillator frequency as a function of resistance (R_X). See Fig. 11.

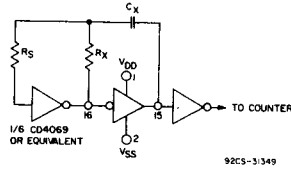

Fig. 11 – Typical RC circuit.

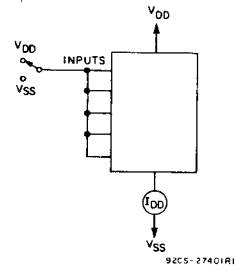

Fig. 12 – Quiescent-device-current test circuit.

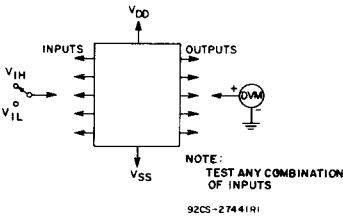

Fig. 13 – Noise-immunity test circuit.

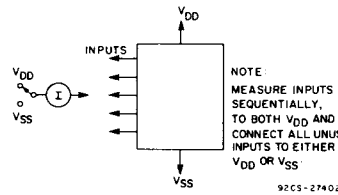

Fig. 14 – Input-leakage-current test circuit.

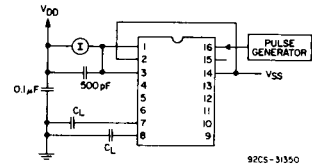
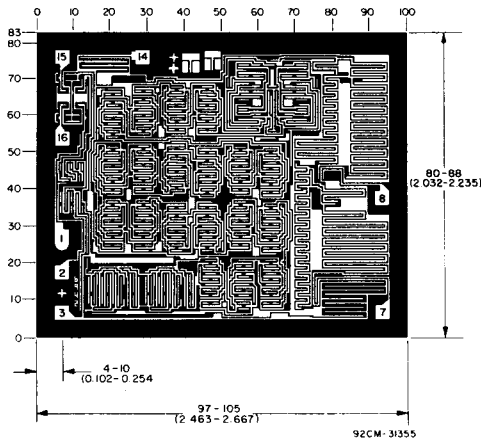

Fig. 15 – Dynamic power dissipation test circuit.



Chip dimensions and pad layout for CD4045B

Dimensions in parentheses are in millimeters and are derived from the basic inch dimensions as indicated. Grid graduations are in mils (10^{-3} inch).

TERMINAL DIAGRAM Top View

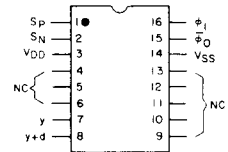

92CS-24478R2

NC=NO CONNECTION

NOTE Observe power-supply terminal connections, V_{DD} is terminal No. 3 and V_{SS} is terminal No. 14 (not 16 and 8 respectively, as in other CD4000B Series 16-lead devices).

3
COMMERCIAL CMOS
HIGH VOLTAGE ICs