

FPF2174 IntelliMAX™ Advanced Load Management Products

Features

- 1.8 to 5.5V Input Voltage Range
- Controlled Turn-On
- 200mA Current Limit Option
- Undervoltage Lockout
- Thermal Shutdown
- $1\mu\text{A}$ Shutdown Current
- Fast Current limit Response Time
 - 3 μs to Moderate Over Currents
 - 20ns to Hard Shorts
- Integrated very low V_F Schottky Diode for Reverse Current Blocking
- Integrated Zener Diode for Output Clamp
- RoHS Compliant

Applications

- PDAs
- Cell Phones
- GPS Devices
- MP3 Players
- Digital Cameras
- Peripheral Ports
- Hot Swap Supplies



General Description

The FPF2174 is a load switch which combines the functionality of the IntelliMAX™ series load switch with a very low forward voltage drop Schottky barrier rectifier and a zener clamp at the output. The integrated solution provides full protection to systems and loads which may encounter large current conditions in a very compact MLP 3x3 package. This device contains a 0.125 Ω current-limited P-channel MOSFET which can operate over an input voltage range of 1.8-5.5V. The Schottky diode acts as a barrier so that no reverse current can flow when the MOSFET is off and the output voltage is higher than the input voltage. Switch control is by a logic input (ON) capable of interfacing directly with low voltage control signals. Each part contains thermal shutdown protection which shuts off the switch to prevent damage to the part when a continuous over-current condition causes excessive heating.

When the switch current reaches the current limit, the part operates in a constant-current mode to prohibit excessive currents from causing damage. If the constant current condition still persists after 10ms, these parts will shut off the switch and pull the fault signal pin (FLAGB) low. The switch will remain off until the ON pin is cycled. The minimum current limit is 200mA.

These parts are available in a space-saving 6L MLP 3x3 package.

Typical Application Circuit

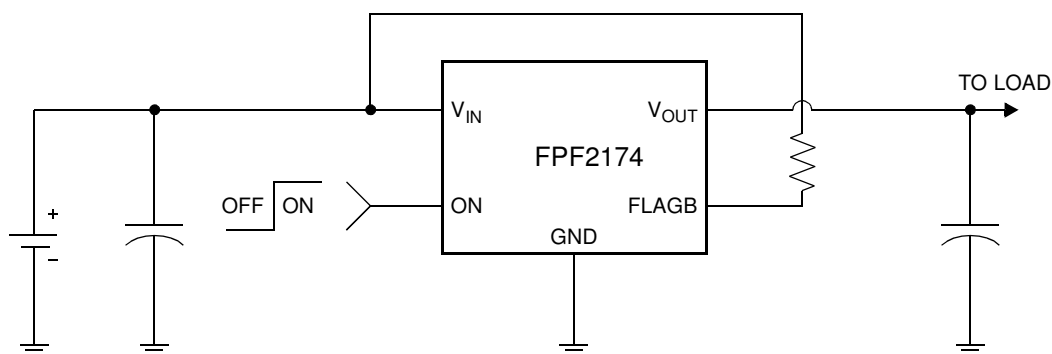

Ordering Information

Part	Current Limit Min [mA]	Current Limit Blanking Time Typ [ms]	Auto-Restart Time [ms]	ON Pin Activity	Top Mark
FPF2174	200	10	NA	Active HI	2174

Functional Block Diagram

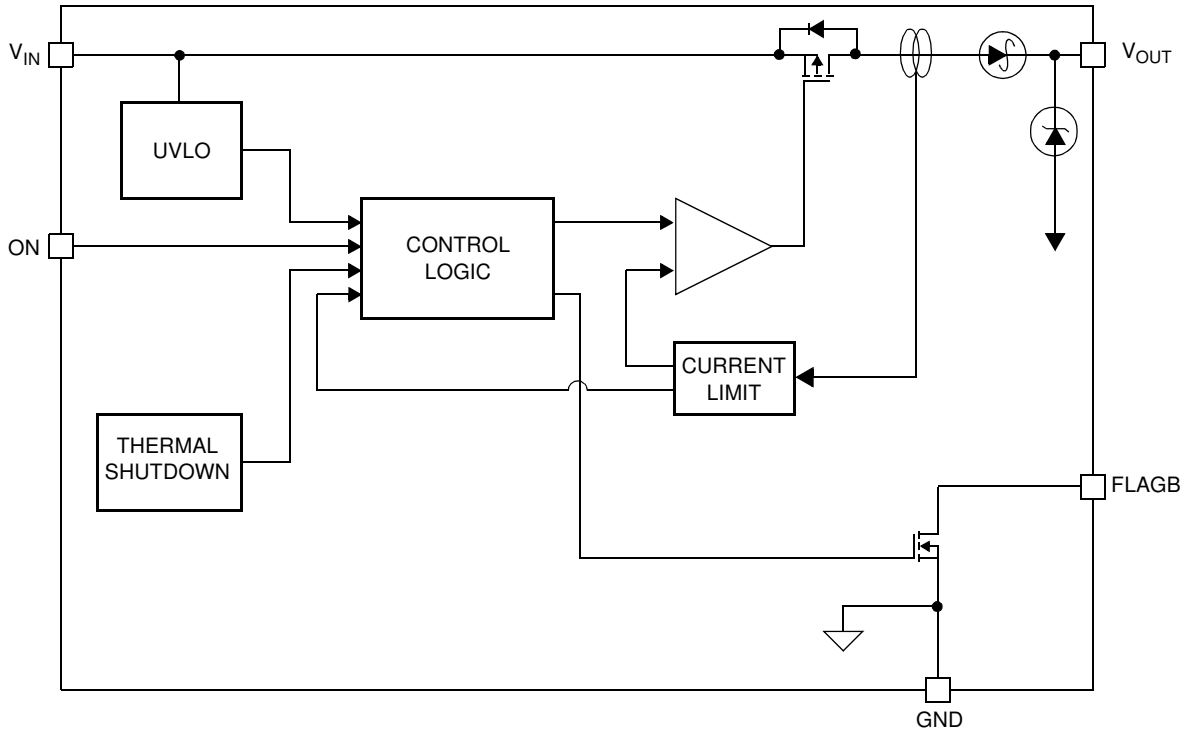

Pin Configuration

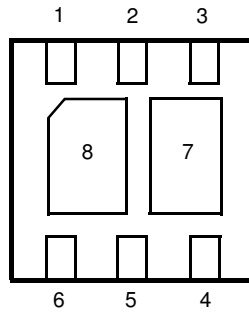

3x3 MLP BOTTOM VIEW

Pin Description

Pin	Name	Function
1	V _{IN}	Supply Input: Input to the power switch and the supply voltage for the IC
2	NC	No Connect
3, 7	V _{OUT}	Switch Output: Output of the power switch
4	GND	Ground
5	FLAGB	Fault Output: Active LO, open drain output which indicates an over current supply, under voltage or over temperature state.
6	ON	ON Control Input
8	PAD1	IC substrate. Can be connected to GND. Do not connect to other pins.

Absolute Maximum Ratings

Parameter		Min	Max	Unit
V_{IN} , ON, FLAGB to GND		-0.3	6	V
V_{OUT} to GND		-0.3	20	V
Power Dissipation @ $T_A = 25^\circ\text{C}$ (note 1)		-	1.4	W
Operating Temperature Range		-40	85	$^\circ\text{C}$
Storage Temperature		-65	150	$^\circ\text{C}$
Thermal Resistance, Junction to Ambient		-	70	$^\circ\text{C}/\text{W}$
Electrostatic Discharge Protection	HBM	4000	-	V
	MM	400	-	V

Recommended Operating Range

Parameter		Min	Max	Unit
V_{IN}		1.8	5.5	V
Ambient Operating Temperature, T_A		-40	85	$^\circ\text{C}$

Electrical Characteristics

$V_{IN} = 1.8$ to 5.5V , $T_A = -40$ to $+85^\circ\text{C}$ unless otherwise noted. Typical values are at $V_{IN} = 3.3\text{V}$ and $T_A = 25^\circ\text{C}$.

Parameter	Symbol	Conditions	Min	Typ	Max	Units	
Basic Operation							
Operating Voltage	V_{IN}		1.8	-	5.5	V	
Quiescent Current	I_Q	$I_{OUT} = 0\text{mA}$ V_{ON} ACTIVE	$V_{IN} = 1.8$ to 3.3V	-	95	-	μA
			$V_{IN} = 3.3$ to 5.5V	-	110	200	
Shutdown Current	I_{SHDN}	$V_{ON} = 0\text{V}$, $I_{OUT} = 0\text{mA}$	-	-	1	μA	
Latch-off Current	$I_{LATCHOFF}$	$V_{ON} = V_{IN}$, after an overcurrent fault	-	50	-	μA	
Reverse Block Leakage Current	I_R	$V_{OUT} = 12\text{V}$, $V_{IN} = V_{ON} = 0\text{V}$, $T_A = 25^\circ\text{C}$	-	-	10	μA	
Reverse Breakdown Voltage		$I_{OUT} = 1\text{mA}$	-	15	-	V	
Dropout Voltage	V_{DROP}	$T_A = 25^\circ\text{C}$, $I_{OUT} = 150\text{mA}$	-	0.3	0.4	V	
		$T_A = 85^\circ\text{C}$, $I_{OUT} = 150\text{mA}$		0.23	-		
		$T_A = -40^\circ\text{C}$, $I_{OUT} = 150\text{mA}$	-	0.36	-		
ON Input Logic High Voltage (ON)	V_{IH}	$V_{IN} = 1.8\text{V}$	0.75	-	-	V	
		$V_{IN} = 5.5\text{V}$	1.3	-	-		
ON Input Logic Low Voltage	V_{IL}	$V_{IN} = 1.8\text{V}$	-	-	0.5	V	
		$V_{IN} = 5.5\text{V}$	-	-	1.0		
ON Input Leakage		$V_{ON} = V_{IN}$ or GND	-	-	1	μA	
Off Switch Leakage	I_{SWOFF}	$V_{ON} = 0\text{V}$, $V_{OUT} = 0\text{V}$ @ $V_{IN} = 5.5\text{V}$, $T_A = 85^\circ\text{C}$			1	μA	
		$V_{ON} = 0\text{V}$, $V_{OUT} = 0\text{V}$ @ $V_{IN} = 3.3\text{V}$, $T_A = 25^\circ\text{C}$		10	100	nA	
FLAGB Output Logic Low Voltage		$V_{IN} = 5\text{V}$, $I_{SINK} = 10\text{mA}$	-	-	0.2	V	
		$V_{IN} = 1.8\text{V}$, $I_{SINK} = 10\text{mA}$	-	-	0.3		
FLAGB Output High Leakage Current		$V_{IN} = 5\text{V}$, Switch on	-	-	1	μA	

Electrical Characteristics Cont.

$V_{IN} = 1.8$ to $5.5V$, $T_A = -40$ to $+85^\circ C$ unless otherwise noted. Typical values are at $V_{IN} = 3.3V$ and $T_A = 25^\circ C$.

Parameter	Symbol	Conditions	Min	Typ	Max	Units
Protections						
Current Limit	I_{LIM}	$V_{IN} = 3.3V$	200	300	400	mA
Thermal Shutdown		Shutdown Threshold	-	140	-	°C
		Return from Shutdown	-	130	-	
		Hysteresis	-	10	-	
Under Voltage Shutdown	UVLO	V_{IN} Increasing	1.5	1.6	1.7	V
Under Voltage Shutdown Hysteresis			-	47	-	mV
Zener Clamp Voltage	V_Z	$I_Z = 1mA$	-	15.58	-	V
Zener Leakage	I_Z	$V_Z = 12V$	-	-	10	μA
Dynamic						
Delay On Time	t_{dON}	$R_L = 500\Omega$, $C_L = 0.1\mu F$	-	25	50	μs
Delay Off Time	t_{dOFF}	$R_L = 500\Omega$, $C_L = 0.1\mu F$	-	20	40	μs
V_{OUT} Rise Time	t_R	$R_L = 500\Omega$, $C_L = 0.1\mu F$	-	14	30	μs
V_{OUT} Fall Time	t_F	$R_L = 500\Omega$, $C_L = 0.1\mu F$	-	126	250	μs
Over Current Blanking Time	t_{BLANK}		5	10	20	ms
Short Circuit Response Time		$V_{IN} = V_{ON} = 3.3V$. Moderate Over-Current Condition.	-	3	-	μs
		$V_{IN} = V_{ON} = 3.3V$. Hard Short.	-	20	-	ns

Note 1: Package power dissipation on 1 square inch pad, 2 oz. copper board.

Typical Characteristics

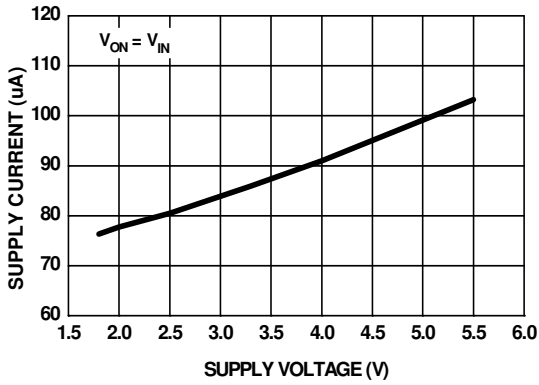

Figure 1. Quiescent Current vs. Input Voltage

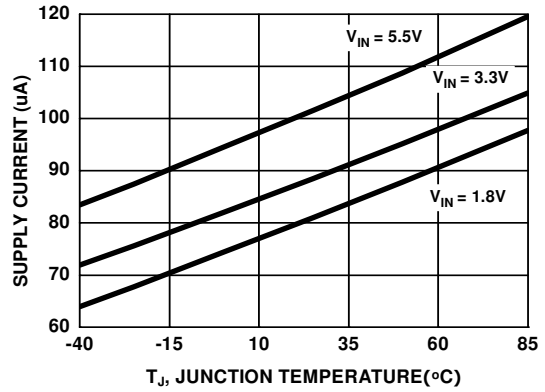

Figure 2. Quiescent Current vs. Temperature

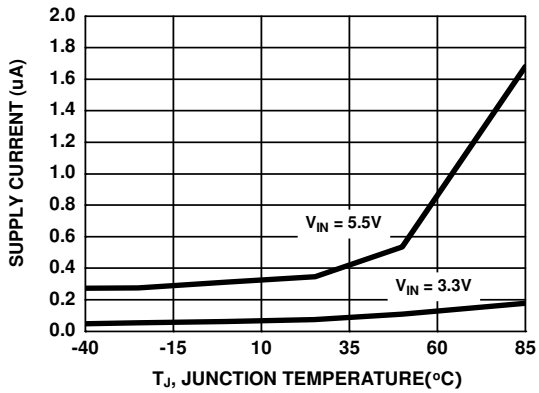

Figure 3. I_{SHUTDOWN} Current vs. Temperature

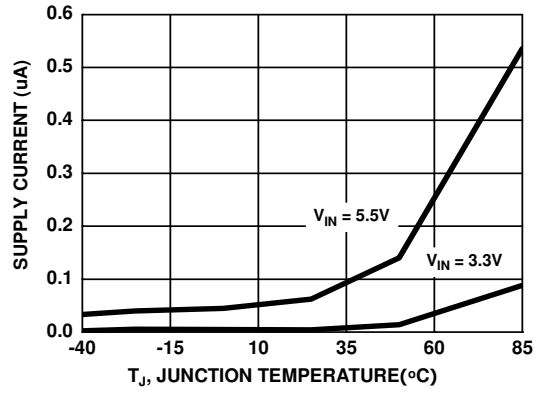

Figure 4. I_{SWITCH-OFF} Current vs. Temperature

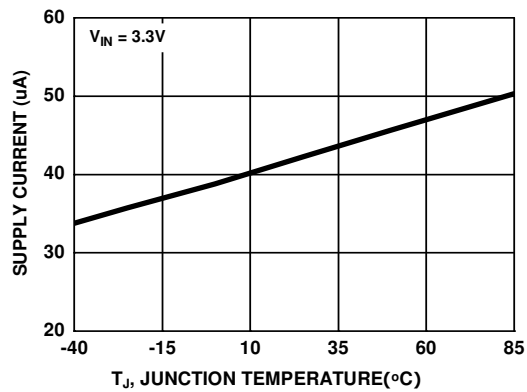

Figure 5. Latchoff current vs. Temperature

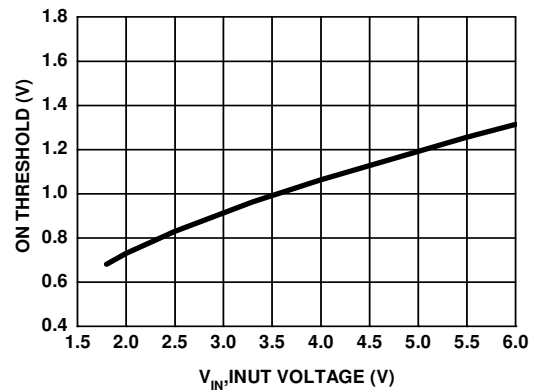

Figure 6. Input Voltage vs. On Threshold Voltage

Typical Characteristics

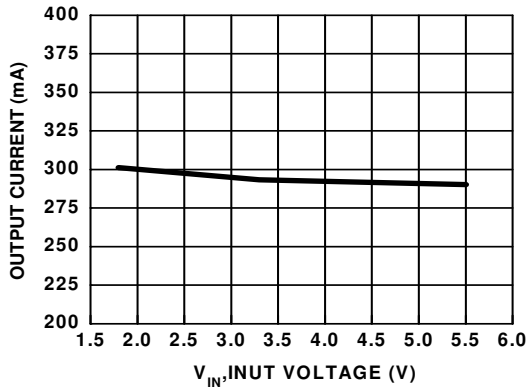

Figure 7. Current Limit vs. Output Voltage

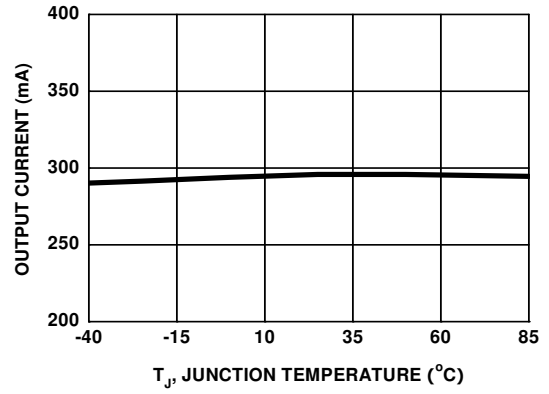

Figure 8. Current Limit vs. Temperature

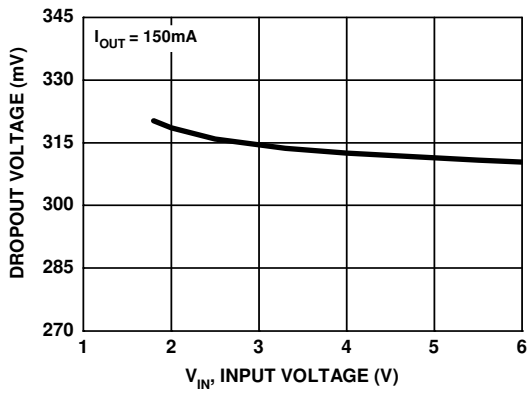

Figure 9. Drop Voltage vs. Input Voltage

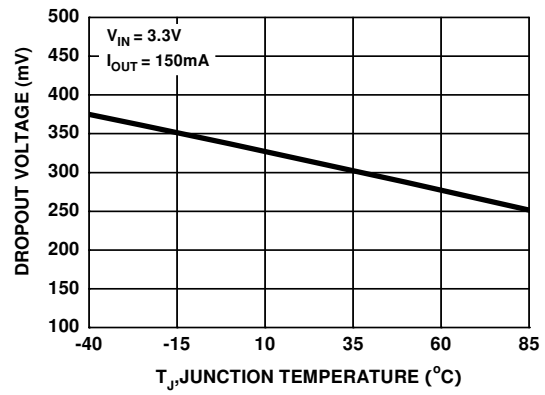

Figure 10. Drop Voltage vs. Temperature

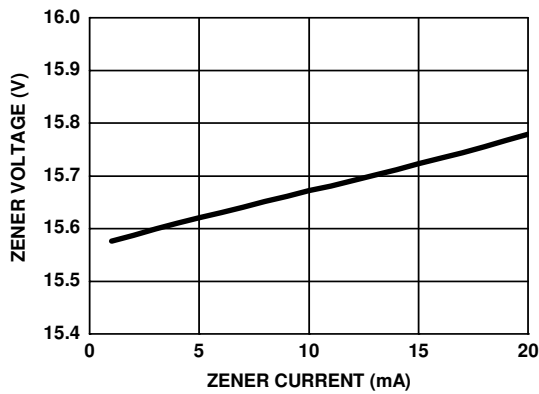

Figure 11. Zener Voltage vs. Zener Current

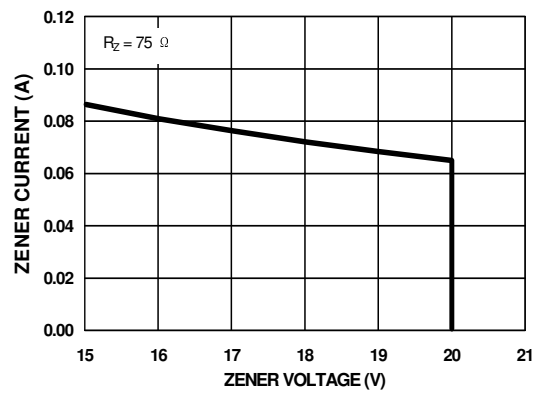

Figure 12. Zener Diode Safe Operating Area

Typical Characteristics

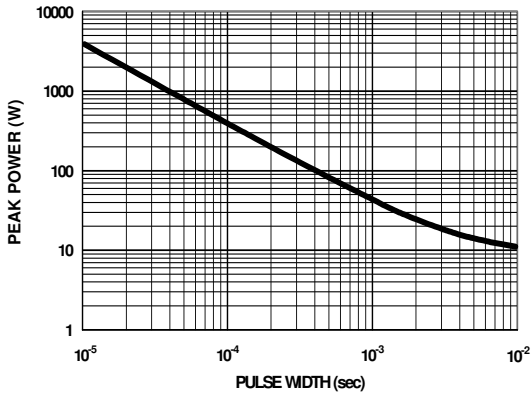

Figure 13. Single Pulse Maximum Power Dissipation of Zener Diode

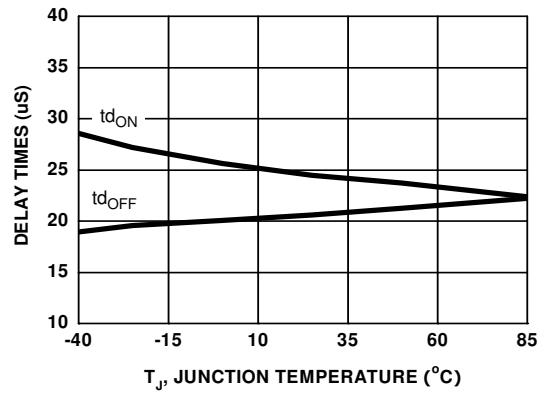

Figure 14. T_{ON}/T_{OFF} vs. Temperature

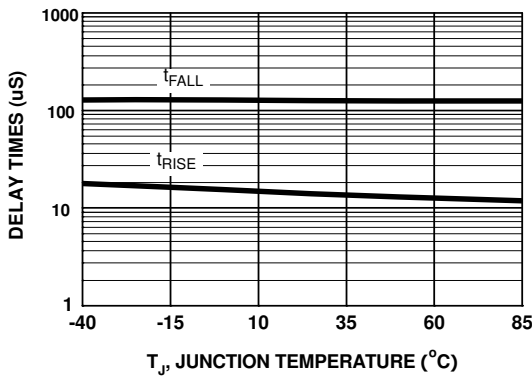

Figure 15. T_{Rise}/T_{Fall} vs. Temperature

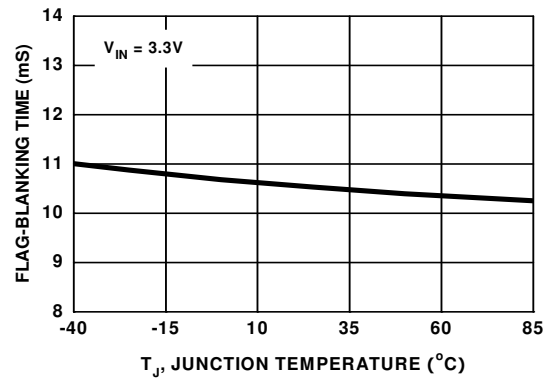

Figure 16. T_{BLANK} vs. Temperature

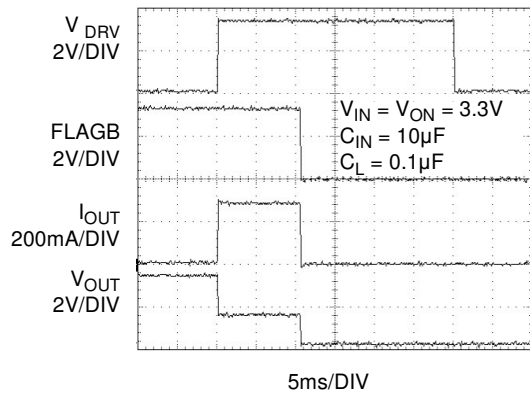

Figure 17. T_{BLANK} Response

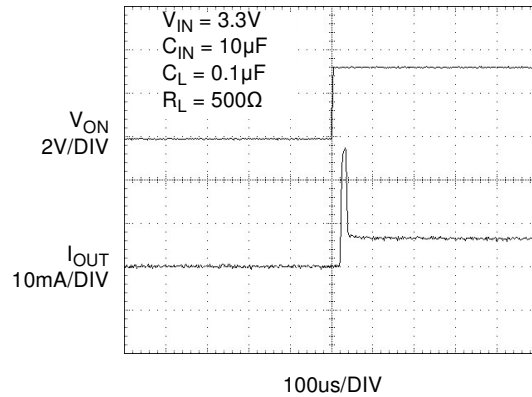

Figure 18. T_{ON} Response

Typical Characteristics

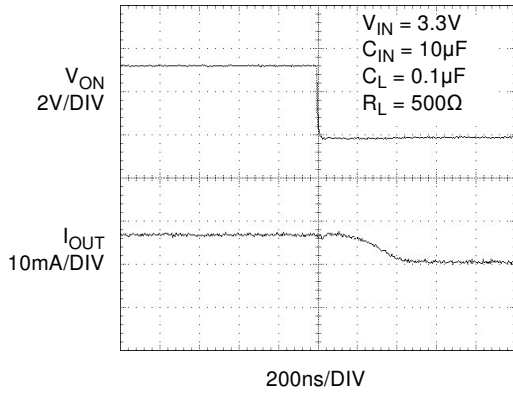

Figure 19. T_{OFF} Response

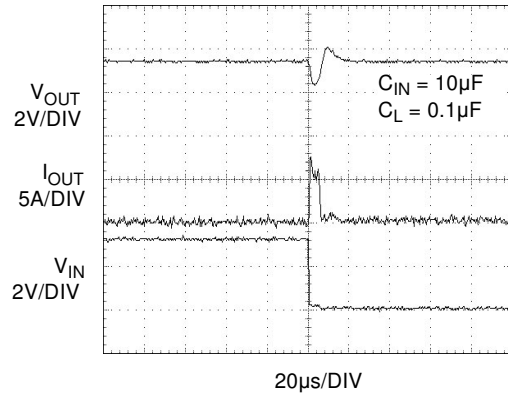

Figure 20. Short Circuit Response Time
(Output Shorted to GND)

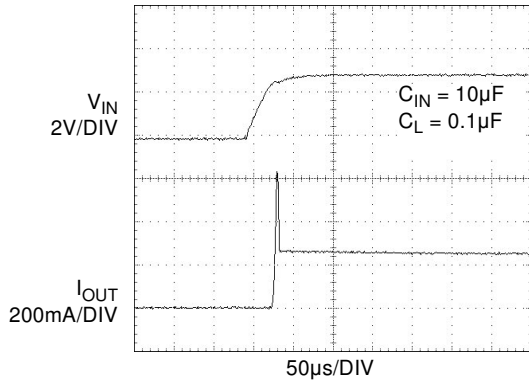

Figure 21. Current Limit Response Time
(Switch power up to hard short)

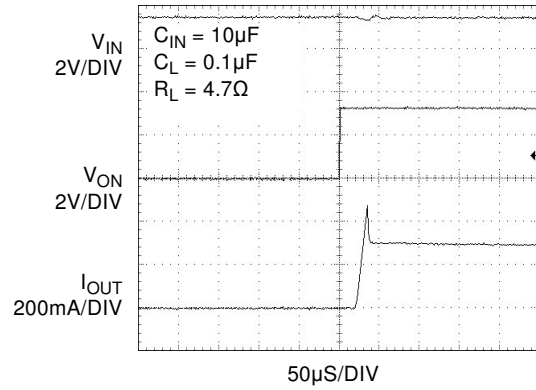

Figure 22. Current Limit Response Time
(Output has a 4.7Ω load)

Description of Operation

The FPF2174 is a current limited switch that protects systems and loads which can be damaged or disrupted by the application of high currents. The core of the device is a 0.125Ω P-channel MOSFET and a controller capable of functioning over a wide input operating range of 1.8-5.5V paired with a low forward voltage drop Schottky diode for reverse blocking and a 16V zener diode for output clamp. The controller protects against system malfunctions through current limiting, under-voltage lockout and thermal shutdown. The current limit is preset for 200mA.

On/Off Control

The ON pin controls the state of the switch. Activating ON continuously holds the switch in the on state so long as there is no under-voltage on V_{IN} or a junction temperature in excess of 150°C. ON is active HI and has a low threshold making it capable of interfacing with low voltage signals. When the MOSFET is off, the Schottky diode acts as a barrier so that no reverse current can flow when V_{OUT} is greater than V_{IN} .

Fault Reporting

Upon the detection of an over-current, an input under-voltage, or an over-temperature condition, the FLAGB signals the fault mode by activating LO. The FLAGB goes LO at the end of the blanking time and is latched LO and ON must be toggled to release it. FLAGB is an open-drain MOSFET which requires a pull-up resistor between V_{IN} and FLAGB. During shutdown, the pull-down on FLAGB is disabled to reduce current draw from the supply.

Current Limiting

The current limit guarantees that the current through the switch doesn't exceed a maximum value while not limiting at less than a minimum value. The minimum current is 200mA and the maximum current is 400mA. The device has a blanking time of 10ms, nominally, during which the switch will act as a constant current source. At the end of the blanking time, the switch will be turned-off and the FLAGB pin will activate to indicate that current limiting has occurred.

Under-Voltage Lockout

The under-voltage lockout turns-off the switch if the input voltage drops below the under-voltage lockout threshold. With the ON pin active the input voltage rising above the under-voltage lockout threshold will cause a controlled turn-on of the switch which limits current over-shoots.

Thermal Shutdown

The thermal shutdown protects the die from internally or externally generated excessive temperatures. During an over-temperature condition the FLAGB is activated and the switch is turned-off. The switch automatically turns-on again if temperature of the die drops below the threshold temperature.

Transient Safe Operating Area of Zener Diode

Integrated zener diode is designed to protect systems from a transient over voltage stress resulting from a flyback voltage ($L \cdot di/dt$) such as connecting the output of switch to an active rails.

When the transient voltage exceed the zener threshold (V_z) the zener starts conducting and prevents the output of loadswitch from experiencing those transient over voltages and protects any reverse current from flowing through the switch. For reliable operation, user should not exceed the SOA curve shown in Figure 13.

Application Information

Typical Application

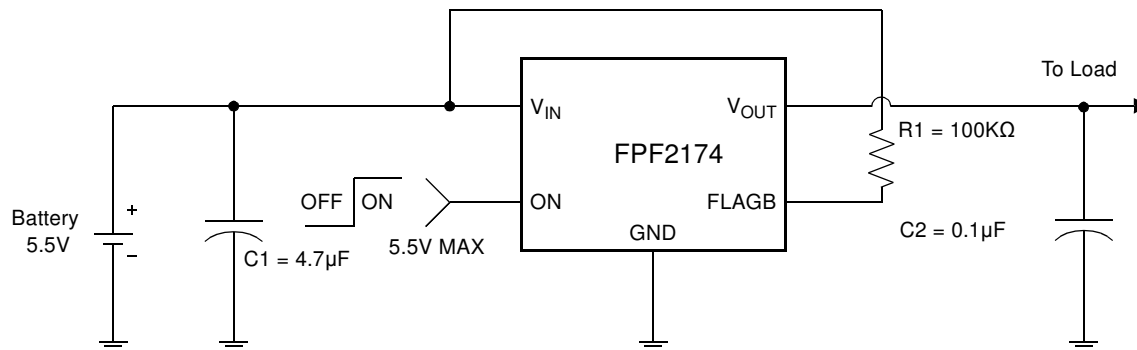

Input Capacitor

To limit the voltage drop on the input supply caused by transient in-rush currents when the switch turns-on into a discharged load capacitor or a short-circuit, a capacitor needs to be placed between V_{IN} and GND. A 4.7µF ceramic capacitor, C_{IN} , placed close to the pins is usually sufficient. Higher values of C_{IN} can be used to further reduce the voltage drop.

Output Capacitor

A 0.1µF capacitor C_{OUT} , should be placed between V_{OUT} and GND. This capacitor will prevent parasitic board inductances from forcing V_{OUT} below GND when the switch turns-off.

Power Dissipation

During normal operation as a switch, the power dissipation is small and has little effect on the operating temperature of the part. The parts with the higher current limits will dissipate the most power and that will only be typically,

$$P = I_{LIM} \times V_{DROP} = 0.4 \times 0.4 = 160\text{mW} \quad (2)$$

When using the part, attention must be given to the manual resetting of the part. Continuously resetting the part at a high duty cycle when a short on the output is present can cause the temperature of the part to increase. The junction temperature will only be allowed to increase to the thermal shutdown threshold. Once this temperature has been reached, toggling ON will not turn-on the switch until the junction temperature drops.

Board Layout

For best performance, all traces should be as short as possible. To be most effective, the input and output capacitors should be placed close to the device to minimize the effects that parasitic trace inductances may have on normal and short-circuit operation. Using wide traces for V_{IN} , V_{OUT} and GND will help minimize parasitic electrical effects along with minimizing the case to ambient thermal impedance.

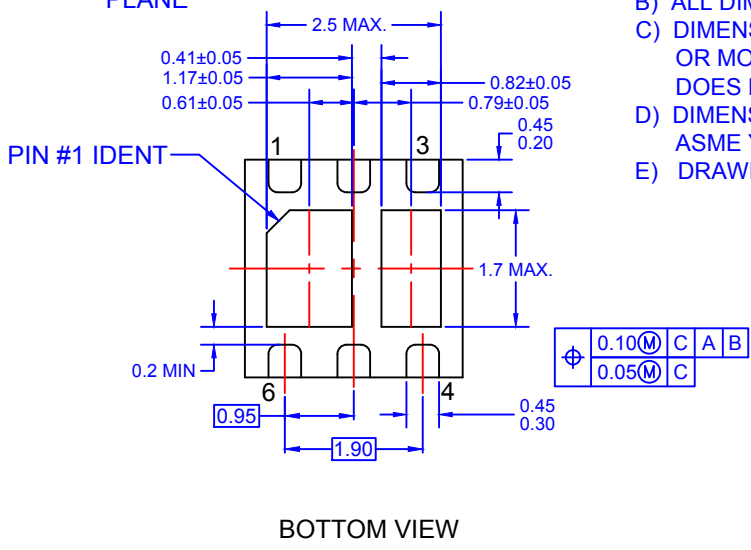
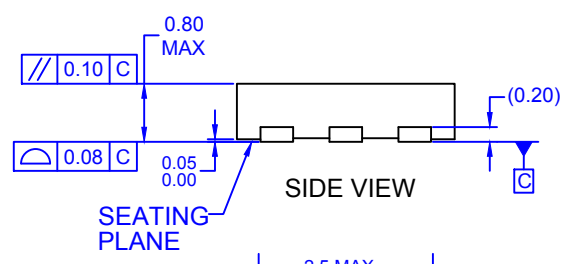
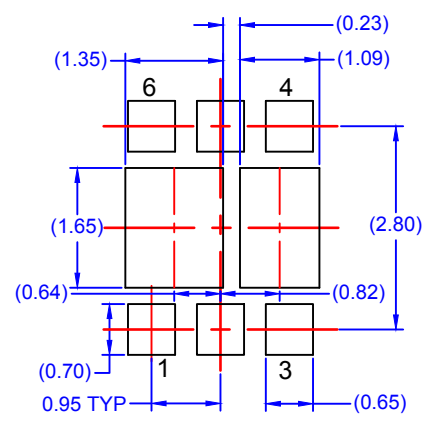
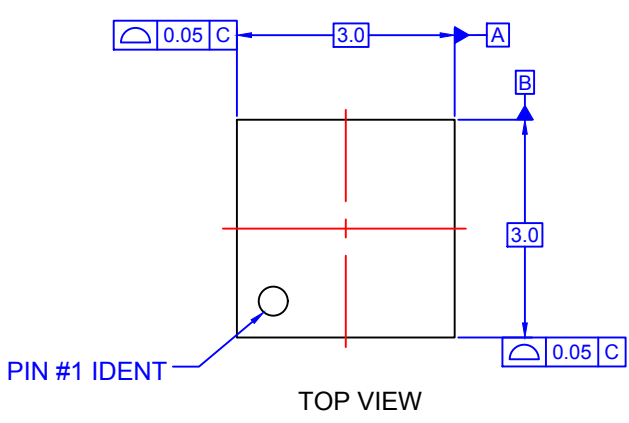

- NOTES: UNLESS OTHERWISE SPECIFIED
- A) CONFORMS TO JEDEC REGISTRATION, MO-229, VARIATION WEEA
 - B) ALL DIMENSIONS ARE IN MILLIMETERS.
 - C) DIMENSIONS DO NOT INCLUDE BURRS OR MOLD FLASH. MOLD FLASH OR BURRS DOES NOT EXCEED 0.10MM.
 - D) DIMENSIONING AND TOLERANCING PER ASME Y14.5M-2009.
 - E) DRAWING FILE NAME: MKT-MLP06HREV2





TRADEMARKS

The following includes registered and unregistered trademarks and service marks, owned by Fairchild Semiconductor and/or its global subsidiaries, and is not intended to be an exhaustive list of all such trademarks.

- | | | | |
|--------------------------|--|---------------------------------------|------------------|
| AccuPower™ | F-PFS™ | OPTOPLANAR® | SYSTEM GENERAL® |
| AttitudeEngine™ | FRFET® | Power Supply WebDesigner™ | TinyBoost® |
| Awinda® | Global Power Resource SM | PowerTrench® | TinyBuck® |
| AX-CAP®* | GreenBridge™ | PowerXS™ | TinyCalc™ |
| BitSiC™ | Green FPS™ | Programmable Active Droop™ | TinyLogic® |
| Build it Now™ | Green FPS™ e-Series™ | QFET® | TINYOPTO™ |
| CorePLUS™ | Gmax™ | QS™ | TinyPower™ |
| CorePOWER™ | GTO™ | Quiet Series™ | TinyPWM™ |
| CROSSVOLT™ | IntelliMAX™ | RapidConfigure™ | TinyWire™ |
| CTL™ | ISOPLANAR™ | Saving our world, 1mW/W/kW at a time™ | TranSiC™ |
| Current Transfer Logic™ | Making Small Speakers Sound Louder and Better™ | SignalWise™ | TriFault Detect™ |
| DEUXPEED® | MegaBuck™ | SmartMax™ | TRUECURRENT®* |
| Dual Cool™ | MICROCOUPLER™ | SMART START™ | μSerDes™ |
| EcoSPARK® | MicroFET™ | Solutions for Your Success™ | UHC® |
| EfficientMax™ | MicroPak™ | SPM® | Ultra FRFET™ |
| ESBC™ | MicroPak2™ | STEALTH™ | UniFET™ |
| F [®] | MillerDrive™ | SuperFET® | VCX™ |
| Fairchild® | MotionMax™ | SuperSOT™-3 | VisualMax™ |
| Fairchild Semiconductor® | MotionGrid® | SuperSOT™-6 | VoltagePlus™ |
| FACT Quiet Series™ | MTi® | SuperSOT™-8 | XST™ |
| FACT® | MTx® | SupreMOS® | Xsens™ |
| FastvCore™ | MVN® | SyncFET™ | 仙童® |
| FETBench™ | mWSaver® | Sync-Lock™ | |
| FPS™ | OptoHiT™ | | |
| | OPTOLOGIC® | | |

* Trademarks of System General Corporation, used under license by Fairchild Semiconductor.

DISCLAIMER

FAIRCHILD SEMICONDUCTOR RESERVES THE RIGHT TO MAKE CHANGES WITHOUT FURTHER NOTICE TO ANY PRODUCTS HEREIN TO IMPROVE RELIABILITY, FUNCTION, OR DESIGN. TO OBTAIN THE LATEST, MOST UP-TO-DATE DATASHEET AND PRODUCT INFORMATION, VISIT OUR WEBSITE AT [HTTP://WWW.FAIRCHILDSEMI.COM](http://www.fairchildsemi.com). FAIRCHILD DOES NOT ASSUME ANY LIABILITY ARISING OUT OF THE APPLICATION OR USE OF ANY PRODUCT OR CIRCUIT DESCRIBED HEREIN; NEITHER DOES IT CONVEY ANY LICENSE UNDER ITS PATENT RIGHTS, NOR THE RIGHTS OF OTHERS. THESE SPECIFICATIONS DO NOT EXPAND THE TERMS OF FAIRCHILD'S WORLDWIDE TERMS AND CONDITIONS, SPECIFICALLY THE WARRANTY THEREIN, WHICH COVERS THESE PRODUCTS.

AUTHORIZED USE

Unless otherwise specified in this data sheet, this product is a standard commercial product and is not intended for use in applications that require extraordinary levels of quality and reliability. This product may not be used in the following applications, unless specifically approved in writing by a Fairchild officer: (1) automotive or other transportation, (2) military/aerospace, (3) any safety critical application – including life critical medical equipment – where the failure of the Fairchild product reasonably would be expected to result in personal injury, death or property damage. Customer's use of this product is subject to agreement of this Authorized Use policy. In the event of an unauthorized use of Fairchild's product, Fairchild accepts no liability in the event of product failure. In other respects, this product shall be subject to Fairchild's Worldwide Terms and Conditions of Sale, unless a separate agreement has been signed by both Parties.

ANTI-COUNTERFEITING POLICY

Fairchild Semiconductor Corporation's Anti-Counterfeiting Policy. Fairchild's Anti-Counterfeiting Policy is also stated on our external website, www.fairchildsemi.com, under Terms of Use

Counterfeiting of semiconductor parts is a growing problem in the industry. All manufacturers of semiconductor products are experiencing counterfeiting of their parts. Customers who inadvertently purchase counterfeit parts experience many problems such as loss of brand reputation, substandard performance, failed applications, and increased cost of production and manufacturing delays. Fairchild is taking strong measures to protect ourselves and our customers from the proliferation of counterfeit parts. Fairchild strongly encourages customers to purchase Fairchild parts either directly from Fairchild or from Authorized Fairchild Distributors who are listed by country on our web page cited above. Products customers buy either from Fairchild directly or from Authorized Fairchild Distributors are genuine parts, have full traceability, meet Fairchild's quality standards for handling and storage and provide access to Fairchild's full range of up-to-date technical and product information. Fairchild and our Authorized Distributors will stand behind all warranties and will appropriately address any warranty issues that may arise. Fairchild will not provide any warranty coverage or other assistance for parts bought from Unauthorized Sources. Fairchild is committed to combat this global problem and encourage our customers to do their part in stopping this practice by buying direct or from authorized distributors.

PRODUCT STATUS DEFINITIONS

Definition of Terms

Datasheet Identification	Product Status	Definition
Advance Information	Formative / In Design	Datasheet contains the design specifications for product development. Specifications may change in any manner without notice.
Preliminary	First Production	Datasheet contains preliminary data; supplementary data will be published at a later date. Fairchild Semiconductor reserves the right to make changes at any time without notice to improve design.
No Identification Needed	Full Production	Datasheet contains final specifications. Fairchild Semiconductor reserves the right to make changes at any time without notice to improve the design.
Obsolete	Not In Production	Datasheet contains specifications on a product that is discontinued by Fairchild Semiconductor. The datasheet is for reference information only.