

National Semiconductor is now part of
Texas Instruments.

Search <http://www.ti.com/> for the latest technical
information and details on our current products and services.

DS36950

Quad Differential Bus Transceiver

General Description

The DS36950 is a low power, space-saving quad EIA-485 differential bus transceiver especially suited for high speed, parallel, multipoint, computer I/O bus applications. A compact 20-pin surface mount PLCC package provides high transceiver integration and a very small PC board footprint.

Timing uncertainty across an interface using multiple devices, a typical problem in a parallel interface, is specified—minimum and maximum propagation delay times are guaranteed.

Six devices can implement a complete IPI master or slave interface. Three transceivers in a package are pinned out for

connection to a parallel databus. The fourth transceiver, with the flexibility provided by its individual enables, can serve as a control bus transceiver.

Features

- Pinout for IPI interface
- Compact 20-pin PLCC package
- Meets EIA-485 standard for multipoint bus transmission
- Greater than 60 mA source/sink
- Thermal Shutdown Protection

Pinout and Logic Diagram

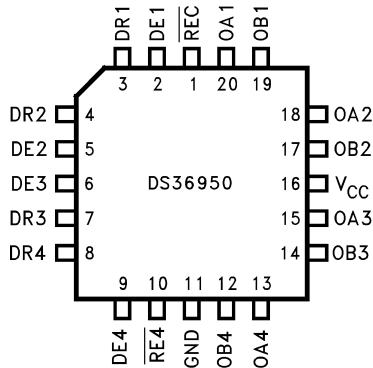

Order Number DS36950
See NS Package Number V20A

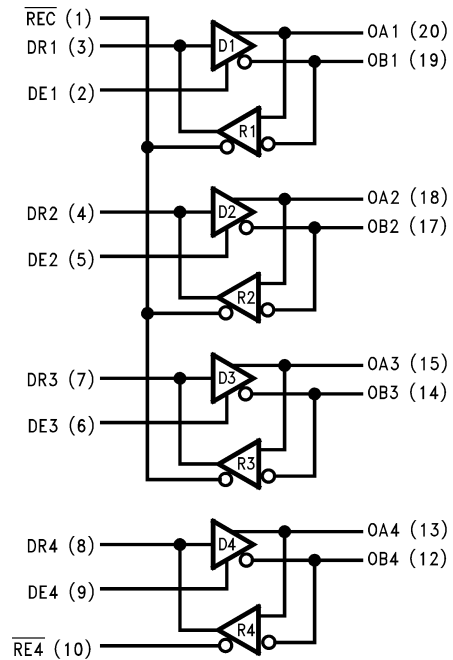

01060202

Absolute Maximum Ratings (Note 1)

If Military/Aerospace specified devices are required, please contact the National Semiconductor Sales Office/Distributors for availability and specifications.

Supply Voltage	7V
Control Input Voltage	$V_{CC} + 0.5V$
Driver Input Voltage	$V_{CC} + 0.5V$
Driver Output Voltage/Receiver Input Voltage	-10V to +15V
Receiver Output Voltage	5.5V
Continuous Power Dissipation @ 25°C	
V Package	1.73W

Derate V Package 13.9 mW/°C above 25°C

Storage Temp. Range	-65°C to +150°C
Lead Temp. (Soldering 4 Sec.)	260°C

Recommended Operating Conditions

Supply Voltage, V_{CC}	4.75V to 5.25V
Bus Voltage	-7V to +12V
Operating Free Air Temp. (T_A)	0°C to +70°C

Electrical Characteristics (Note 2)

Over Supply Voltage and Operating Temperature ranges, unless otherwise specified

Symbol	Parameter	Conditions	Min	Typ	Max	Units
DRIVER CHARACTERISTICS						
V_{ODL}	Differential Driver Output Voltage (Full Load)	$I_L = 60 \text{ mA}$ $V_{CM} = 0V$	1.5	1.9		V
V_{OD}	Differential Driver Output Voltage (Termination Load)	$R_L = 100\Omega$ (EIA-422)	2.0	3.5		V
		$R_L = 54\Omega$ (EIA-485)	1.5	3.2		V
ΔV_{ODI}	Change in Magnitude of Driver Differential Output Voltage for Complementary Output States	$R_L = 54\Omega$ or 100Ω (Note 4) (Figure 1) (EIA-485)			0.2	V
V_{OC}	Driver Common Mode Output Voltage (Note 5)	$R_L = 54\Omega$ (Figure 1) (EIA-485)			3.0	V
ΔV_{OCI}	Change in Magnitude of Common Mode Output Voltage	(Note 4) (Figure 1) (EIA-485)			0.2	V
V_{OH}	Output Voltage HIGH	$I_{OH} = -55 \text{ mA}$	2.7	3.2		V
V_{OL}	Output Voltage LOW	$I_{OL} = 55 \text{ mA}$		1.4	1.7	V
V_{IH}	Input Voltage HIGH		2.0			V
V_{IL}	Input Voltage LOW				0.8	V
V_{CL}	Input Clamp Voltage	$I = -18 \text{ mA}$			-1.5	V
I_{IH}	Input High Current	$V_I = 2.4V$ (Note 3)			20	μA
I_{IL}	Input Low Current	$V_I = 0.4V$ (Note 3)			-20	μA
I_{OSC}	Driver Short-Circuit Output Current (Note 9)	$V_O = -7V$ (EIA-485)		-130	-250	mA
		$V_O = 0V$ (EIA-422)		-90	-150	mA
		$V_O = +12V$ (EIA-485)		130	250	mA
RECEIVER CHARACTERISTICS						
I_{OSR}	Short Circuit Output Current	$V_O = 0V$ (Note 9)	-15	-28	-75	mA
I_{OZ}	TRI-STATE® Output Current	$V_O = 0.4V$ to $2.4V$			20	μA
V_{OH}	Output Voltage High	$V_{ID} = 0.20V$, $I_{OH} = -0.4 \text{ mA}$	2.4	3.0		V
V_{OL}	Output Voltage Low	$V_{ID} = -0.20V$, $I_{OL} = 4 \text{ mA}$		0.35	0.5	V
V_{TH}	Differential Input High Threshold Voltage	$V_O = V_{OH}$, $I_O = -0.4 \text{ mA}$ (EIA-422/485)		0.03	0.20	V
V_{TL}	Differential Input Low Threshold Voltage (Note 6)	$V_O = V_{OL}$, $I_O = 4.0 \text{ mA}$ (EIA-422/485)	-0.20	-0.03		V
V_{HST}	Hysteresis (Note 7)	$V_{CM} = 0V$	35	60		mV
DRIVER AND RECEIVER CHARACTERISTICS						
V_{IH}	Enable Input Voltage High		2.0			V
V_{IL}	Enable Input Voltage Low				0.8	V

Electrical Characteristics (Note 2) (Continued)

Over Supply Voltage and Operating Temperature ranges, unless otherwise specified

Symbol	Parameter	Conditions	Min	Typ	Max	Units	
DRIVER AND RECEIVER CHARACTERISTICS							
V_{CL}	Enable Input Clamp Voltage	$I = -18 \text{ mA}$			-1.5	V	
I_{IN}	Line Input Current (Note 8)	Other Input = 0V	$V_I = +12\text{V}$		0.5	1	mA
			$V_I = -7\text{V}$		-0.45	-0.8	mA
I_{IH}	Enable Input Current High	$V_{OH} = 2.4\text{V}$	$\overline{RE4}$ or DE			20	μA
			\overline{REC}			60	μA
I_{IL}	Enable Input Current Low	$V_{OL} = 0.4\text{V}$	$\overline{RE4}$ or DE			-20	μA
			\overline{REC}			-60	μA
I_{CC}	Supply Current (Note 10)	No Load, Outputs Enabled		75	90	mA	
I_{CCZ}	Supply Current (Note 10)	No Load, Outputs Disabled		50	70	mA	

Switching Characteristics

Over Supply Voltage and Operating Temperature ranges, unless otherwise specified

Symbol	Conditions	Min	Typ	Max	Units	
DRIVER SINGLE-ENDED CHARACTERISTICS						
t_{PZH}	$R_L = 110\Omega$ (Figure 4)		35	40	ns	
t_{PZL}	$R_L = 110\Omega$ (Figure 5)		25	40	ns	
t_{PHZ}	$R_L = 110\Omega$ (Figure 4)		15	25	ns	
t_{PLZ}	$R_L = 110\Omega$ (Figure 5)		35	40	ns	
DRIVER DIFFERENTIAL CHARACTERISTICS						
t_R, t_F	Rise & Fall Time	$R_L = 54\Omega$		13	16	ns
t_{PLHD}	Differential Propagation	$C_L = 50 \text{ pF}$	9	15	19	ns
t_{PHLD}	Delays (Note 15)	$C_D = 15 \text{ pF}$	9	15	19	ns
t_{SKD}	$ t_{PLHD} - t_{PHLD} $ Differential Skew	(Figures 3, 8)		3	6	ns
RECEIVER CHARACTERISTICS						
t_{PLHD}	Differential Propagation Delays		9	14	19	ns
t_{PHLD}	$C_L = 15 \text{ pF}, V_{CM} = 1.5\text{V}$ (Figure 6)		9	14	19	ns
t_{SKD}	$ t_{PLHD} - t_{PHLD} $ Differential Receiver Skew			1	3	ns
t_{ZH}	Output Enable Time to High Level	$C_L = 15 \text{ pF}$ (Figure 7)		15	22	ns
t_{ZL}	Output Enable Time to Low Level			20	30	ns
t_{HZ}	Output Disable Time from High Level			10	17	ns
t_{LZ}	Output Disable Time from Low Level			17	25	ns

Note 1: "Absolute Maximum Ratings" are those values beyond which the safety of the device cannot be guaranteed. They are not meant to imply that the devices should be operated at these limits. The tables of "Electrical Characteristics" specify conditions for device operation.

Note 2: Current into device pins is define as positive. Current out of device pins is defined as negative. All voltages are referenced to ground unless otherwise specified.

Note 3: I_{IH} and I_{IL} includes driver input current and receiver TRI-STATE leakage current.

Note 4: ΔV_{OD} and ΔV_{OC} are changes in magnitude of V_{OD} and V_{OC} , respectively, that occur when the input changes state.

Note 5: In EIA Standards EIA-422 and EIA-485, V_{OC} , which is the average of the two output voltages with respect to ground, is called output offset voltage, V_{OS} .

Note 6: Threshold parameter limits specified as an algebraic value rather than by magnitude.

Note 7: Hysteresis defined as $V_{HST} = V_{TH} - V_{TL}$.

Note 8: I_{IN} includes the receiver input current and driver TRI-STATE leakage current.

Note 9: Short one output at a time.

Note 10: Total package supply current.

Note 11: All typicals are given for $V_{CC} = 5.0\text{V}$ and $T_A = 25^\circ\text{C}$.

Parameter Measurement Information

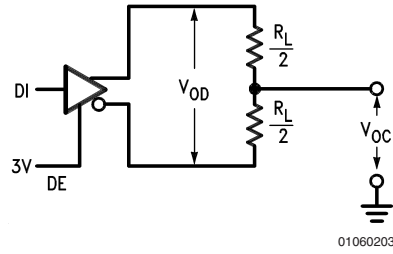

FIGURE 1. Driver V_{OD} and V_{OC}

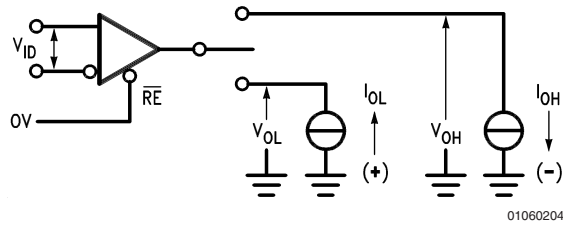

FIGURE 2. Receiver V_{OH} and V_{OL}

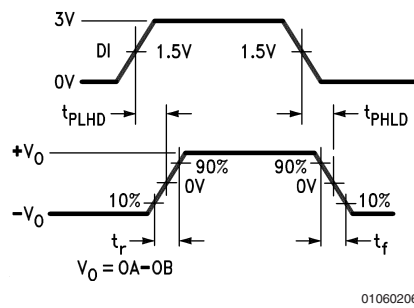
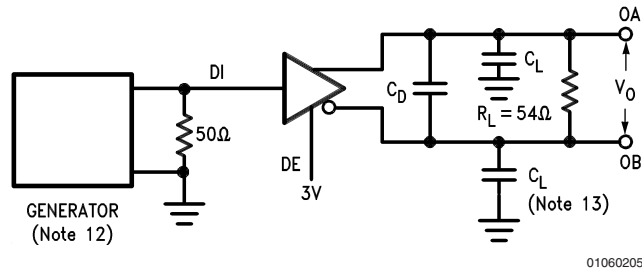
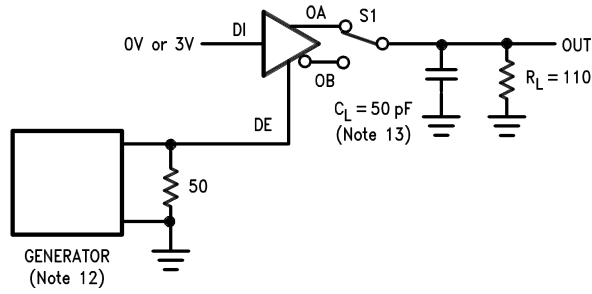

FIGURE 3. Driver Differential Propagation Delay and Transition Timing

Parameter Measurement Information (Continued)



S1 to OA for DI = 3V
 S1 to OB for DI = 0V

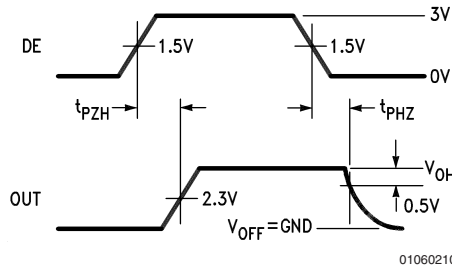
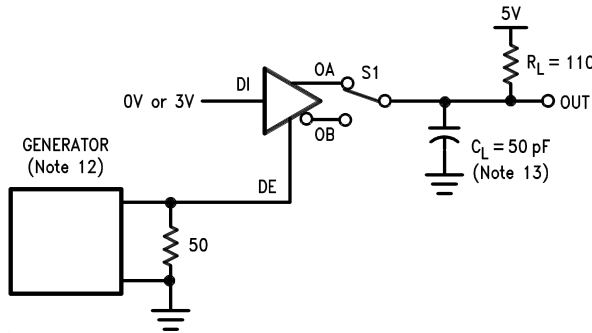

FIGURE 4. Driver Enable and Disable Timing (t_{PZH} , t_{PHZ})



S1 to OA for DI = 0V
 S1 to OB for DI = 3V

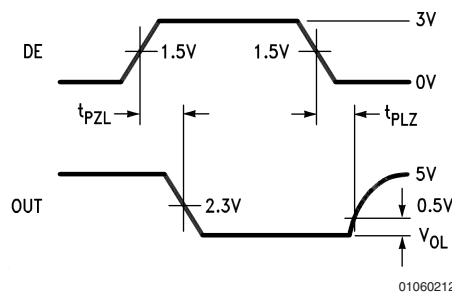
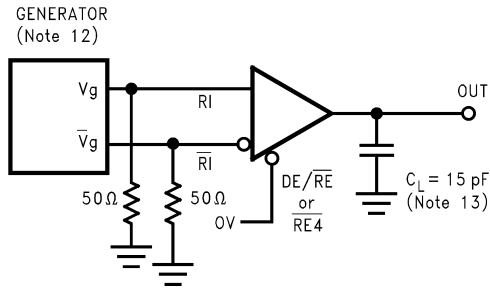
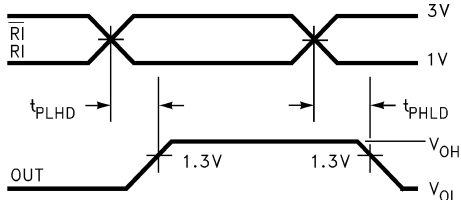

FIGURE 5. Driver Enable and Disable Timing (t_{PZL} , t_{PLZ})

Parameter Measurement Information (Continued)



01060213



01060214

FIGURE 6. Receiver Differential Propagation Delay Timing

Parameter Measurement Information (Continued)

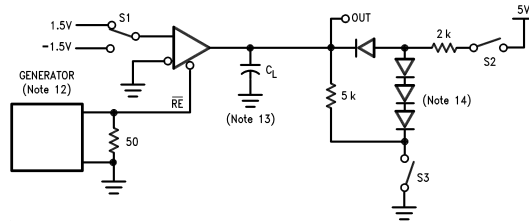

01060215

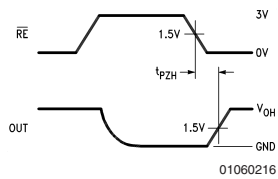

S1 1.5V
S2 OPEN
S3 CLOSED

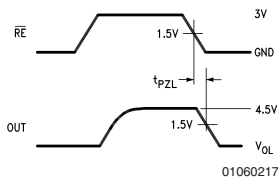

S1 -1.5V
S2 CLOSED
S3 OPEN

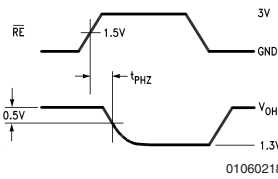

S1 1.5V
S2 CLOSED
S3 CLOSED

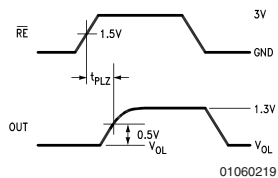

S1 -1.5V
S2 CLOSED
S3 CLOSED

FIGURE 7. Receiver Enable and Disable Timing

Parameter Measurement Information (Continued)

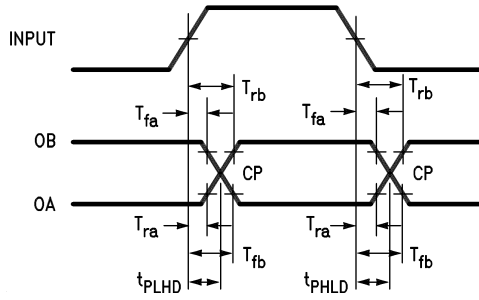

01060220

TCP = Crossing Point

Tra, Trb, Tfa, and Tfb are propagation delay measurements to the 20% and 80% levels.

$$TCP = \frac{(Tfb \times Trb) - (Tra \times Tfa)}{Trb - Tra - Tfa + Tfb}$$

FIGURE 8. Propagation Delay Timing for Calculation of Driver Differential Propagation Delays

Note 12: The input pulse is supplied by a generator having the following characteristics:

f = 1.0 MHz, 50% Duty Cycle, t_r and $t_f < 6.0$ ns, $Z_O = 50\Omega$

Note 13: C_L includes probe and stray capacitance.

Note 14: Diodes are 1N916 or equivalent.

Note 15: Differential propagation delays are calculated from single-ended propagation delays measured from driver input to the 20% and 80% levels on the driver outputs (See Figure 8).

Typical Performance Characteristics

Driver Differential Propagation Delay vs Temperature

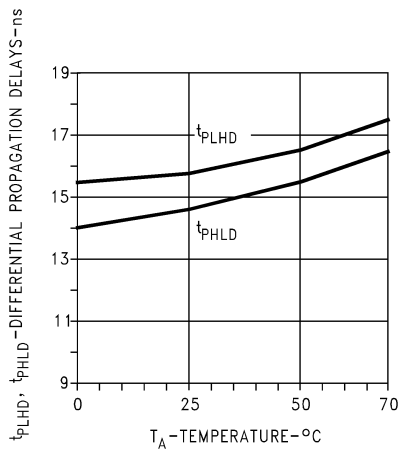

01060223

Driver Differential Propagation Delay vs VCC

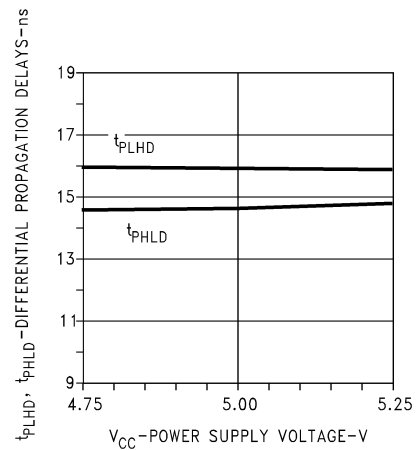

01060224

Typical Performance Characteristics (Continued)

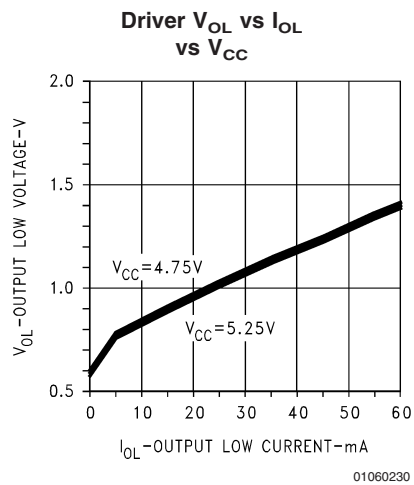
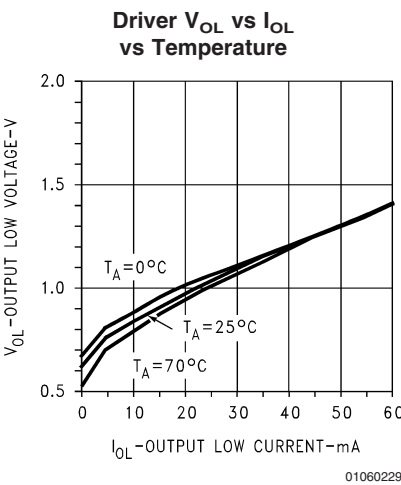
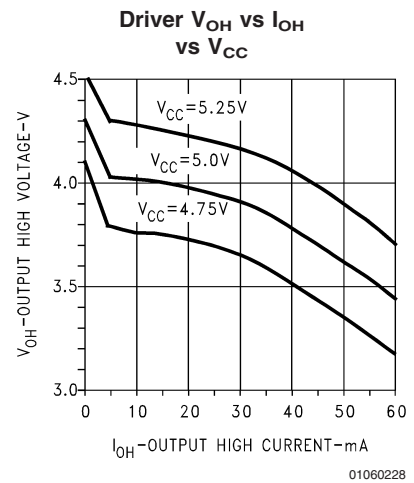
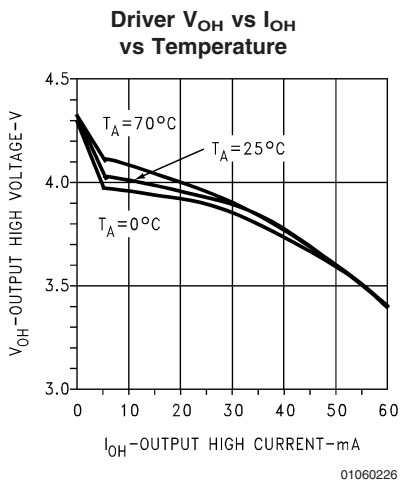
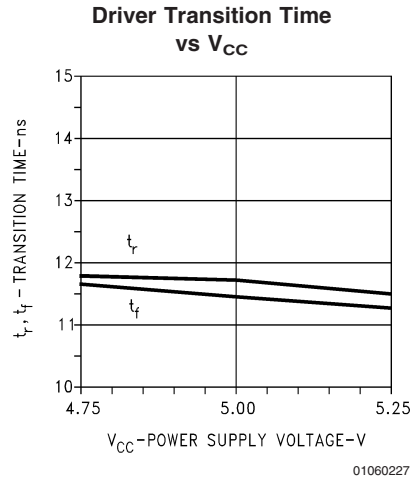
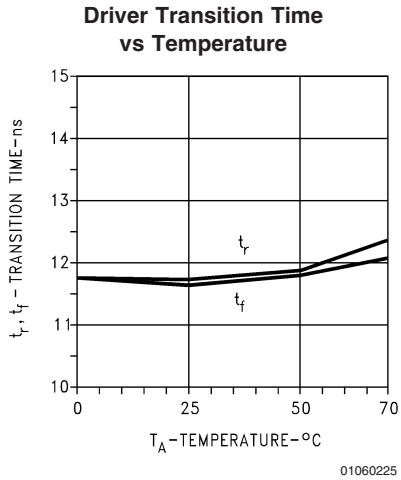

Typical Performance Characteristics (Continued)

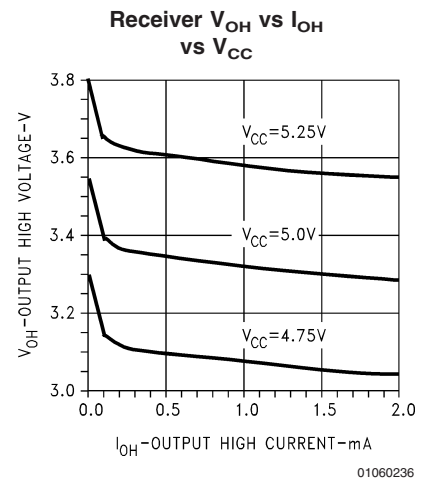
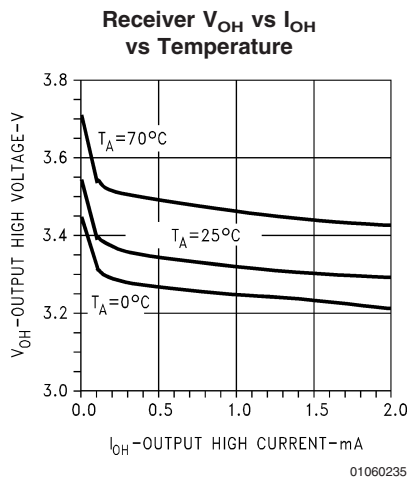
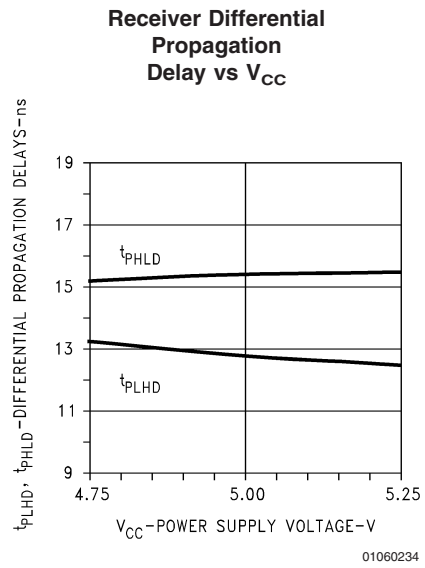
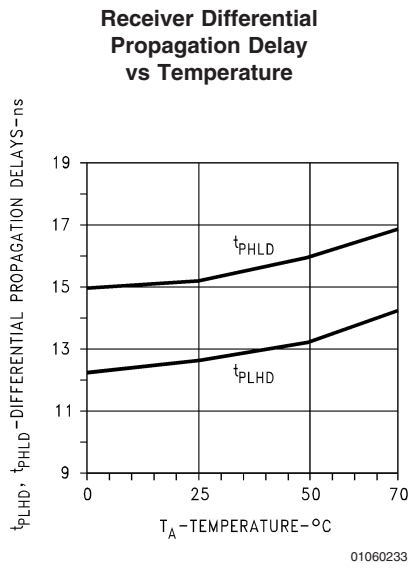
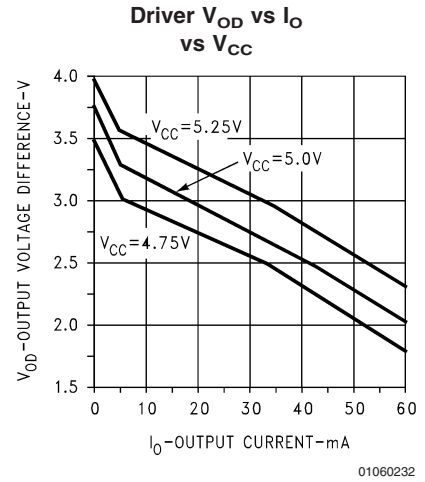
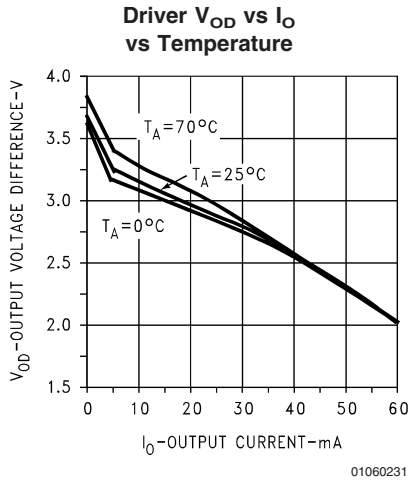

Typical Performance Characteristics (Continued)

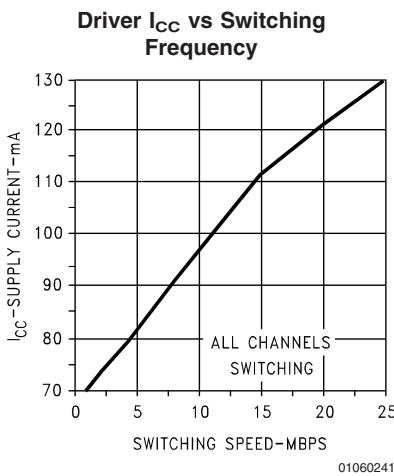
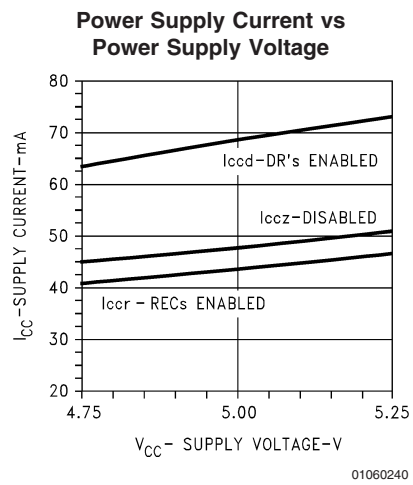
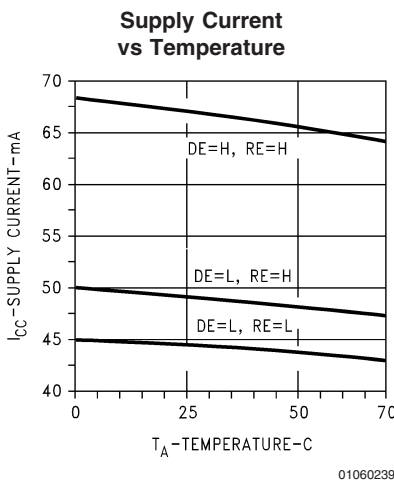
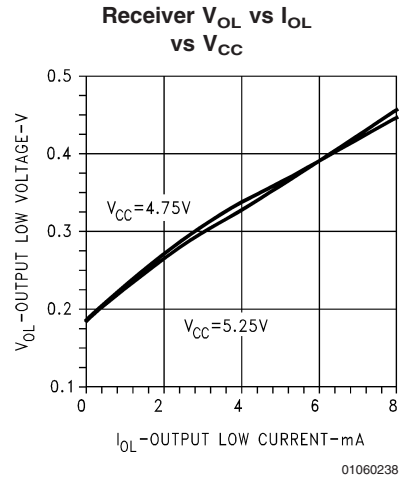
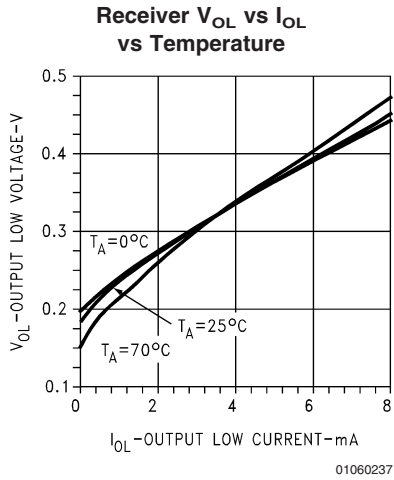

Physical Dimensions inches (millimeters) unless otherwise noted

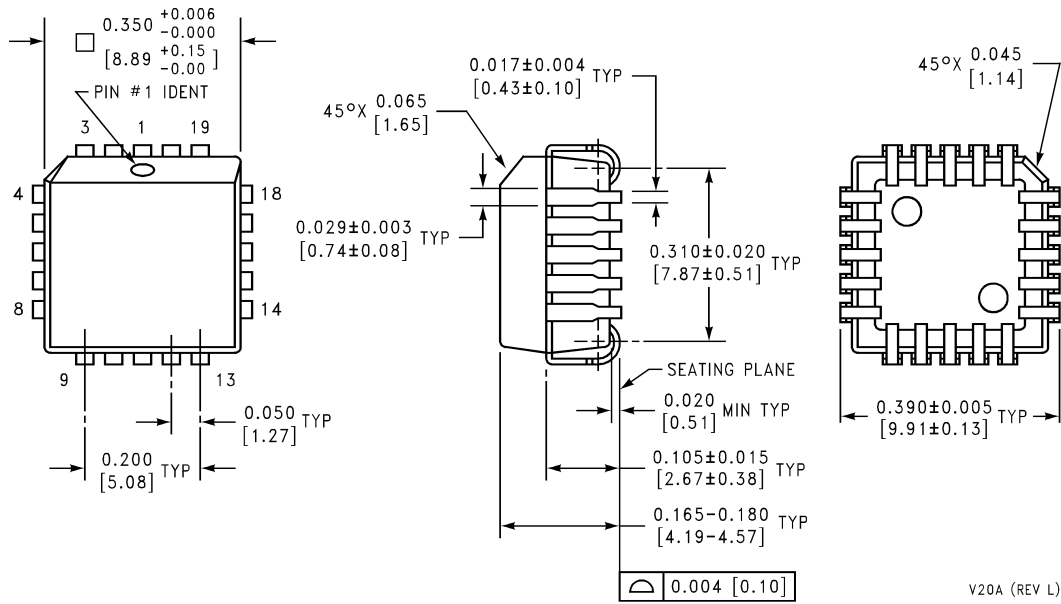

Order Number DS36950
NS Package Number V20A

V20A (REV L)

National does not assume any responsibility for use of any circuitry described, no circuit patent licenses are implied and National reserves the right at any time without notice to change said circuitry and specifications.

For the most current product information visit us at www.national.com.

LIFE SUPPORT POLICY

NATIONAL'S PRODUCTS ARE NOT AUTHORIZED FOR USE AS CRITICAL COMPONENTS IN LIFE SUPPORT DEVICES OR SYSTEMS WITHOUT THE EXPRESS WRITTEN APPROVAL OF THE PRESIDENT AND GENERAL COUNSEL OF NATIONAL SEMICONDUCTOR CORPORATION. As used herein:

1. Life support devices or systems are devices or systems which, (a) are intended for surgical implant into the body, or (b) support or sustain life, and whose failure to perform when properly used in accordance with instructions for use provided in the labeling, can be reasonably expected to result in a significant injury to the user.
2. A critical component is any component of a life support device or system whose failure to perform can be reasonably expected to cause the failure of the life support device or system, or to affect its safety or effectiveness.

BANNED SUBSTANCE COMPLIANCE

National Semiconductor certifies that the products and packing materials meet the provisions of the Customer Products Stewardship Specification (CSP-9-111C2) and the Banned Substances and Materials of Interest Specification (CSP-9-111S2) and contain no "Banned Substances" as defined in CSP-9-111S2.

 **National Semiconductor**
Americas Customer
Support Center
Email: new.feedback@nsc.com
Tel: 1-800-272-9959

National Semiconductor
Europe Customer Support Center
Fax: +49 (0) 180-530 85 86
Email: europe.support@nsc.com
Deutsch Tel: +49 (0) 69 9508 6208
English Tel: +44 (0) 870 24 0 2171
Français Tel: +33 (0) 1 41 91 8790

National Semiconductor
Asia Pacific Customer
Support Center
Email: ap.support@nsc.com

National Semiconductor
Japan Customer Support Center
Fax: 81-3-5639-7507
Email: jpn.feedback@nsc.com
Tel: 81-3-5639-7560