

## 100MHz Current Feedback Video Amplifier with Disable

January 1996

### Features

- This Circuit is Processed in Accordance to MIL-STD-883 and is Fully Conformant Under the Provisions of Paragraph 1.2.1.
- Wide Unity Gain Bandwidth ..... 105MHz (Min)
- Slew Rate ..... 800V/ $\mu$ s
- Output Current .....  $\pm$ 30mA (Min)
- Drives 3.5V into 75 $\Omega$
- Differential Gain ..... 0.025%
- Differential Phase ..... 0.025 Deg
- Low Input Noise Voltage ..... 4.5nV/ $\sqrt{\text{Hz}}$
- Low Supply Current ..... 10mA (Max)
- Wide Supply Range .....  $\pm$ 5V to  $\pm$ 15V
- Output Enable/Disable
- High Performance Replacement for EL2020/883

### Applications

- Unity Gain Video/Wideband Buffer
- Video Gain Block
- Video Distribution Amp/Coax Cable Driver
- Flash A/D Driver
- Waveform Generator Output Driver
- Current to Voltage Converter; D/A Output Buffer
- Radar Systems
- Imaging Systems

### Description

The HA-5020/883 is a wide bandwidth, high slew rate amplifier optimized for video applications and gains between 1 and 10. Manufactured on Harris' Reduced Feature Complementary Bipolar DI process, this amplifier uses current mode feedback to maintain higher bandwidth at a given gain than conventional voltage feedback amplifiers. Since it is a closed loop device, the HA-5020/883 offers better gain accuracy and lower distortion than open loop buffers.

The HA-5020/883 features low differential gain and phase and will drive two double terminated 75 $\Omega$  coax cables to video levels with low distortion. Adding a gain flatness performance of 0.1dB makes this amplifier ideal for demanding video applications. The bandwidth and slew rate of the HA-5020/883 are relatively independent of closed loop gain. The 105MHz unity gain bandwidth only decreases to 77MHz at a gain of 10. The HA-5020/883 used in place of a conventional op amp will yield a significant improvement in the speed power product. To further reduce power, the HA-5020/883 has a disable function which significantly reduces supply current, while forcing the output to a true high impedance state. This allows the outputs of multiple amplifiers to be wire-OR'd into multiplexer configurations. The device also includes output short circuit protection and output offset voltage adjustment.

The HA-5020/883 offers significant enhancements over competing amplifiers, such as the EL2020. Improvements include unity gain bandwidth, slew rate, video performance, lower supply current, and superior DC specifications.

### Ordering Information

PART NUMBER	TEMPERATURE RANGE	PACKAGE
HA7-5020/883	-55°C to +125°C	8 Lead CerDIP
HA4-5020/883	-55°C to +125°C	20 Lead Ceramic LCC

### Pinouts

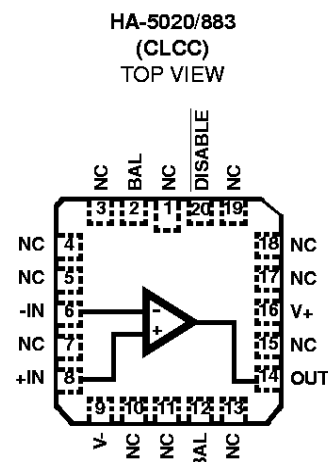
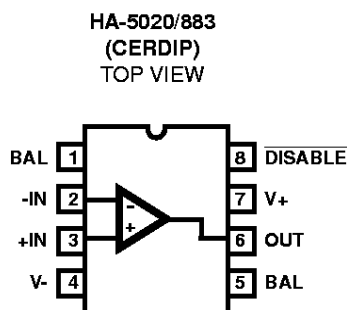

## Specifications HA-5020/883

### Absolute Maximum Ratings

Voltage Between V+ and V- Terminals	36V
Differential Input Voltage	8V
Voltage at Either Input Terminal	V+ to V-
Peak Output Current	Full Short Circuit Protected
Junction Temperature (T <sub>J</sub> )	+175°C
Storage Temperature Range	-65°C to +150°C
ESD Rating	< 2000V
Lead Temperature (Soldering 10s)	+300°C

### Thermal Information (Typical)

Thermal Package Characteristics	$\theta_{JA}$	$\theta_{JC}$
CerDIP Package	115°C/W	30°C/W
Ceramic LCC Package	75°C/W	23°C/W
Package Power Dissipation Limit at +75°C for T <sub>J</sub> ≤ +175°C		
CerDIP Package	0.87W	
Ceramic LCC Package	1.33W	
Package Power Dissipation Derating Factor Above +75°C		
CerDIP Package	8.7mW/°C	
Ceramic LCC Package	13.3mW/°C	

**CAUTION:** Stresses above those listed in "Absolute Maximum Ratings" may cause permanent damage to the device. This is a stress only rating and operation of the device at these or any other conditions above those indicated in the operational sections of this specification is not implied.

### Operating Conditions

Operating Temperature Range	-55°C to +125°C	$V_{INCM} \leq 1/2(V+ - V-)$	$R_F = 1k\Omega$
Operating Supply Voltage	±5V to ±15V	$R_L \geq 400\Omega$	$V_{DISABLE} = V+ \text{ or } 0V$

**TABLE 1. DC ELECTRICAL PERFORMANCE CHARACTERISTICS**

Device Tested at: Supply Voltage = ±15V, R<sub>SOURCE</sub> = 0Ω, A<sub>VCL</sub> = +1, R<sub>F</sub> = 1kΩ, R<sub>LOAD</sub> = 400Ω, V<sub>OUT</sub> = 0V, V<sub>DISABLE</sub> = V+, Unless Otherwise Specified.

PARAMETERS	SYMBOL	CONDITIONS	GROUP A SUBGROUP	TEMPERATURE	LIMITS		UNITS
					MIN	MAX	
Input Offset Voltage	V <sub>IO</sub>	V <sub>CM</sub> = 0V	1	+25°C	-8	8	mV
			2, 3	+125°C, -55°C	-10	10	mV
Common Mode Rejection Ratio	+CMRR	$\Delta V_{CM} = +10V, V+ = 5V, V- = -25V$	1	+25°C	60	-	dB
			2, 3	+125°C, -55°C	50	-	dB
	-CMRR	$\Delta V_{CM} = -10V, V+ = 25V, V- = -5V$	1	+25°C	60	-	dB
			2, 3	+125°C, -55°C	50	-	dB
Power Supply Rejection Ratio	+PSRR	$\Delta V_{SUP} = 13.5V, V+ = 4.5V, V- = -15V; V+ = 18V, V- = -15V$	1	+25°C	64	-	dB
			2, 3	+125°C, -55°C	60	-	dB
	-PSRR	$\Delta V_{SUP} = 13.5V, V+ = 15V, V- = -4.5V; V+ = 15V, V- = -18V$	1	+25°C	64	-	dB
			2, 3	+125°C, -55°C	60	-	dB
Non-Inverting (+IN) Current	I <sub>BP</sub>	V <sub>CM</sub> = 0V	1	+25°C	-8	8	μA
			2, 3	+125°C, -55°C	-20	20	μA
+IN Common Mode Rejection	IBPCMP	$\Delta V_{CM} = +10V, V+ = 5V, V- = -25V$	1	+25°C	-	0.1	μA/V
			2, 3	+125°C, -55°C	-	0.5	μA/V
	IBPCMN	$\Delta V_{CM} = -10V, V+ = 25V, V- = -5V$	1	+25°C	-	0.1	μA/V
			2, 3	+125°C, -55°C	-	0.5	μA/V
Non-Inverting (+IN) Input Impedance	+R <sub>IN</sub>	Calculated 1/IBPCMP	1	+25°C	10	-	MΩ
			2, 3	+125°C, -55°C	2	-	MΩ
+IN Power Supply Rejection	IBPPSP	$\Delta V_{SUP} = 13.5V, V+ = 4.5V, V- = -15V; V+ = 18V, V- = -15V$	1	+25°C	-	0.06	μA/V
			2, 3	+125°C, -55°C	-	0.2	μA/V
	IBPPSN	$\Delta V_{SUP} = 13.5V, V+ = 15V, V- = -4.5V; V+ = 15V, V- = -18V$	1	+25°C	-	0.06	μA/V
			2, 3	+125°C, -55°C	-	0.2	μA/V
Inverting Input (-IN) Current	I <sub>BN</sub>	V <sub>CM</sub> = 0V	1	+25°C	-20	20	μA
			2, 3	+125°C, -55°C	-50	50	μA

## Specifications HA-5020/883

**TABLE 1. DC ELECTRICAL PERFORMANCE CHARACTERISTICS (Continued)**

Device Tested at: Supply Voltage =  $\pm 15V$ ,  $R_{SOURCE} = 0\Omega$ ,  $A_{VCL} = +1$ ,  $R_F = 1k\Omega$ ,  $R_{LOAD} = 400\Omega$ ,  $V_{OUT} = 0V$ ,  $V_{DISABLE} = V+$ ,  
Unless Otherwise Specified.

PARAMETERS	SYMBOL	CONDITIONS	GROUP A SUBGROUP	TEMPERATURE	LIMITS		UNITS
					MIN	MAX	
-IN Common Mode Rejection	IBNCMP	$\Delta V_{CM} = +10V$ , $V+ = 5V$ , $V- = -25V$	1	+25°C	-	0.4	$\mu A/V$
			2, 3	+125°C, -55°C	-	0.5	$\mu A/V$
	IBNCMN	$\Delta V_{CM} = -10V$ , $V+ = 25V$ , $V- = -5V$	1	+25°C	-	0.4	$\mu A/V$
			2, 3	+125°C, -55°C	-	0.5	$\mu A/V$
-IN Power Supply Rejection	IBNPSP	$\Delta V_{SUP} = 13.5V$ , $V+ = 4.5V$ , $V- = -15V$ ; $V+ = 18V$ , $V- = -15V$	1	+25°C	-	0.2	$\mu A/V$
			2, 3	+125°C, -55°C	-	0.5	$\mu A/V$
	IBNPSN	$\Delta V_{SUP} = 13.5V$ , $V+ = 15V$ , $V- = -4.5V$ ; $V+ = 15V$ , $V- = -18V$	1	+25°C	-	0.2	$\mu A/V$
			2, 3	+125°C, -55°C	-	0.5	$\mu A/V$
Common Mode Range	+CMR	$V+ = 5V$ , $V- = -25V$	1	+25°C	10	-	V
			2, 3	+125°C, -55°C	10	-	V
	-CMR	$V+ = 25V$ , $V- = -5V$	1	+25°C	-	-10	V
			2, 3	+125°C, -55°C	-	-10	V
Transimpedance	+AZOL1	$R_L = 400\Omega$ , $V_{OUT} = 0$ to 10V	1	+25°C	1	-	M $\Omega$
			2, 3	+125°C, -55°C	1	-	M $\Omega$
	-AZOL1	$R_L = 400\Omega$ , $V_{OUT} = 0$ to -10V	1	+25°C	1	-	M $\Omega$
			2, 3	+125°C, -55°C	1	-	M $\Omega$
Output Voltage Swing	+V <sub>OUT</sub>	$V_{IN} = 12.8V$	1, 2	+25°C, +125°C	12	-	V
			3	-55°C	11	-	V
	-V <sub>OUT</sub>	$V_{IN} = -12.8V$	1, 2	+25°C, +125°C	-	-12	V
			3	-55°C	-	-11	V
	+V <sub>OUT5</sub>	$V+ = 5V$ , $V- = -5V$ , $V_{IN} = 3V$	1	+25°C	2	-	V
			2, 3	+125°C, -55°C	2	-	V
	-V <sub>OUT5</sub>	$V+ = 5V$ , $V- = -5V$ , $V_{IN} = -3V$	1	+25°C	-	-2	V
			2, 3	+125°C, -55°C	-	-2	V
Output Current	+I <sub>OUT</sub>	Note 1	1, 2	+25°C, +125°C	30	-	mA
			3	-55°C	27.5	-	mA
	-I <sub>OUT</sub>	Note 1	1, 2	+25°C, +125°C	-	-30	mA
			3	-55°C	-	-27.5	mA
Short Circuit Output Current	+I <sub>SC</sub>	$R_L = \text{Open}$ , $V_{IN} = 10V$	1	+25°C	50	-	mA
			2, 3	+125°C, -55°C	50	-	mA
	-I <sub>SC</sub>	$R_L = \text{Open}$ , $V_{IN} = -10V$	1	+25°C	-	-50	mA
			2, 3	+125°C, -55°C	-	-50	mA
Disabled Output Current	+I <sub>LEAK</sub>	$V_{IN} = 0V$ , $V_{OUT} = +10V$ , $R_L = \text{Open}$ , $V_{DIS} = 0V$	1	+25°C	-1	1	$\mu A$
			3	-55°C	-1	1	$\mu A$
		2	+125°C	-1	1	$\mu A$	
	-I <sub>LEAK</sub>	$V_{IN} = 0V$ , $V_{OUT} = -10V$ , $R_L = \text{Open}$ , $V_{DIS} = 0V$	1	+25°C	-1	1	$\mu A$
			3	-55°C	-1	1	$\mu A$
		2	+125°C	-1	1	$\mu A$	

## Specifications HA-5020/883

**TABLE 1. DC ELECTRICAL PERFORMANCE CHARACTERISTICS (Continued)**

Device Tested at: Supply Voltage =  $\pm 15V$ ,  $R_{SOURCE} = 0\Omega$ ,  $A_{VCL} = +1$ ,  $R_F = 1k\Omega$ ,  $R_{LOAD} = 400\Omega$ ,  $V_{OUT} = 0V$ ,  $V_{\overline{DISABLE}} = V+$ , Unless Otherwise Specified.

PARAMETERS	SYMBOL	CONDITIONS	GROUP A SUBGROUP	TEMPERATURE	LIMITS		UNITS
					MIN	MAX	
Disable Pin Input Current	$I_{LOGIC}$	$V_{\overline{DIS}} = 0V$	1, 2	+25°C, +125°C	-1	0	mA
			3	-55°C	-1.5	0	mA
Minimum DISABLE Pin Current to Disable	$I_{DIS}$	Note 2	1	+25°C	-	350	$\mu A$
			2, 3	+125°C, -55°C	-	350	$\mu A$
Maximum DISABLE Pin Current to Enable	$I_{EN}$	Note 3	1	+25°C	20	-	$\mu A$
			2, 3	+125°C, -55°C	20	-	$\mu A$
Quiescent Power Supply Current	$I_{CC}$	$R_L = 400\Omega$	1	+25°C	-	10	mA
			2, 3	+125°C, -55°C	-	10	mA
	$I_{EE}$	$R_L = 400\Omega$	1	+25°C	-10	-	mA
			2, 3	+125°C, -55°C	-10	-	mA
Disabled Power Supply Current	$I_{CCDIS}$	$R_L = 400\Omega$ , $V_{\overline{DIS}} = 0V$	1	+25°C	-	5.6	mA
			2, 3	+125°C, -55°C	-	7.5	mA
	$I_{EEDIS}$	$R_L = 400\Omega$ , $V_{\overline{DIS}} = 0V$	1	+25°C	-5.6	-	mA
			2, 3	+125°C, -55°C	-7.5	-	mA
Offset Voltage Adjustment	$+V_{ADJ}$	Note 4	1	+25°C	30	-	mV
			2, 3	+125°C, -55°C	25	-	mV
	$-V_{ADJ}$	Note 4	1	+25°C	-	-30	mV
			2, 3	+125°C, -55°C	-	-25	mV

**NOTES:**

- Guaranteed from  $V_{OUT}$  test by  $I_{OUT} = V_{OUT}/400\Omega$ .
- This is the minimum current which must be sourced from the  $\overline{DISABLE}$  pin, to disable the output. The output is considered disabled when  $V_{OUT} \leq 10mV$ . Conditions are:  $V_{IN} = 10V$ ,  $R_L = 100\Omega$ . The test is performed by sourcing  $350\mu A$  from the  $\overline{DISABLE}$  pin, and testing that the output decreases below the test limit (10mV).
- This is the maximum current that can be sourced from the  $\overline{DISABLE}$  pin with the device remaining enabled. The device is considered disabled when the supply current decreases by at least 0.5mA. Conditions are:  $R_L = 400\Omega$ . Test is performed by sourcing  $20\mu A$  from the  $\overline{DISABLE}$  pin, and testing that the supply current decreases by no more than the test limit (0.5mA).
- The offset adjustment range is referred to the output. The inverting input current ( $-I_{BIAS}$ ) can be adjusted with an external pot between pins 1 and 5, wiper connected to  $V+$ . Since  $-I_{BIAS}$  flows through  $R_F$ , an adjustment of offset voltage results. The amount of offset adjustment is proportional to the value of  $R_F$ . Test conditions are:  $R_L = Open$ ,  $10k\Omega$  from pin 5 to  $V+$ ,  $1k\Omega$  from pin 1 to  $V+$ , for  $+V_{ADJ}$ ;  $R_L = Open$ ,  $1k\Omega$  from pin 5 to  $V+$ ,  $10k\Omega$  from pin 1 to  $V+$ , for  $-V_{ADJ}$ .

**TABLE 2. AC ELECTRICAL PERFORMANCE CHARACTERISTICS**

Device Tested at: Supply Voltage =  $\pm 15V$ ,  $R_{SOURCE} = 50\Omega$ ,  $R_{LOAD} = 400\Omega$ ,  $C_{LOAD} \leq 10pF$ ,  $A_{VCL} = +1V/V$ , Unless Otherwise Specified.

PARAMETERS	SYMBOL	CONDITIONS	GROUP A SUBGROUP	TEMPERATURE	LIMITS		UNITS
					MIN	MAX	
Slew Rate	+SR	$V_{IN} = -10V$ to $+10V$	4	+25°C	600	-	$V/\mu s$
			5, 6	+125°C, -55°C	400	-	$V/\mu s$
	-SR	$V_{IN} = +10V$ to $-10V$	4	+25°C	600	-	$V/\mu s$
			5, 6	+125°C, -55°C	400	-	$V/\mu s$

## Specifications HA-5020/883

**TABLE 3. ELECTRICAL PERFORMANCE CHARACTERISTICS**

Device Characterized at: Supply Voltage =  $\pm 15V$ ,  $R_{SOURCE} = 50\Omega$ ,  $R_{LOAD} = 400\Omega$ ,  $R_F = 1k\Omega$ ,  $V_{\overline{DISABLE}} = V+$ ,  $C_{LOAD} \leq 10pF$ ,  $A_{VCL} = +1V/V$ , Unless Otherwise Specified.

PARAMETERS	SYMBOL	CONDITIONS	NOTES	TEMPERATURE	LIMITS		UNITS
					MIN	MAX	
-3dB Bandwidth	BW <sub>1</sub>	V <sub>O</sub> = 100mV <sub>RMS</sub> , A <sub>V</sub> = +1	1	+25°C	105	-	MHz
	BW <sub>10</sub>	V <sub>O</sub> = 100mV <sub>RMS</sub> , A <sub>V</sub> = +10, R <sub>F</sub> = 360Ω, R <sub>L</sub> = Open	1	+25°C	77	-	MHz
Gain Flatness	GF <sub>5</sub>	V <sub>O</sub> = 100mV <sub>RMS</sub> , f = 5MHz	1	+25°C	-0.075	+0.075	dB
	GF <sub>10</sub>	V <sub>O</sub> = 100mV <sub>RMS</sub> , f = 10MHz	1	+25°C	-0.2	+0.2	dB
Rise Time	t <sub>R</sub>	V <sub>O</sub> = 0V to 1V, R <sub>L</sub> = 100Ω	1, 2	+25°C	-	3.7	ns
Fall Time	t <sub>F</sub>	V <sub>O</sub> = 1V to 0V, R <sub>L</sub> = 100Ω	1, 3	+25°C	-	4.0	ns
Overshoot	+OVS	V <sub>O</sub> = 0V to 1V, R <sub>L</sub> = 100Ω	1	+25°C	-	18.0	%
	-OVS	V <sub>O</sub> = 1V to 0V, R <sub>L</sub> = 100Ω	1	+25°C	-	16.6	%
Slew Rate	+SR <sub>10</sub>	V <sub>O</sub> = -10V to 10V, A <sub>V</sub> = +10, R <sub>F</sub> = 360Ω, R <sub>L</sub> = Open	1, 4	+25°C	1070	-	V/μs
	-SR <sub>10</sub>	V <sub>O</sub> = 10V to -10V, A <sub>V</sub> = +10, R <sub>F</sub> = 360Ω, R <sub>L</sub> = Open	1, 5	+25°C	860	-	V/μs
Disable Time	+t <sub>DIS</sub>	V <sub>O</sub> = 2V to 0V, 50% of V <sub>DIS</sub> to 90% V <sub>O</sub>	1, 6	+25°C	-	3.13	μs
	-t <sub>DIS</sub>	V <sub>O</sub> = -2V to 0V, 50% of V <sub>DIS</sub> to 90% V <sub>O</sub>	1, 6	+25°C	-	2.44	μs
Enable Time	+t <sub>EN</sub>	V <sub>O</sub> = 0V to 2V, 50% to 90%	1, 7	+25°C	-	1.45	μs
	-t <sub>EN</sub>	V <sub>O</sub> = 0V to -2V, 50% to 90%	1, 7	+25°C	-	1.49	μs

**NOTES:**

- Parameters listed in Table 3 are controlled via design or process parameters and are not directly tested at final production. These parameters are lab characterized upon initial design release, or upon design changes. These parameters are guaranteed by characterization based upon data from multiple production runs which reflect lot to lot and within lot variation.
- Measured from 10% to 90% of the output waveform.
- Measured from 90% to 10% of the output waveform.
- Measured from 25% to 75% of the output waveform.
- Measured from 75% to 25% of the output waveform.
- $\overline{DISABLE} = +15V$  to 0V. Measured from the 50% of  $\overline{DISABLE}$  to V<sub>OUT</sub> =  $\pm 200mV$ .
- $\overline{DISABLE} = 0V$  to +15V. Measured from the 50% of  $\overline{DISABLE}$  to V<sub>OUT</sub> =  $\pm 1.8V$ .

**TABLE 4. ELECTRICAL TEST REQUIREMENTS**

MIL-STD-883 TEST REQUIREMENTS	SUBGROUPS (SEE TABLES 1 AND 2)
Interim Electrical Parameters (Pre Burn-In)	1
Final Electrical Test Parameters	1 (Note 1), 2, 3, 4, 5, 6
Group A Test Requirements	1, 2, 3, 4, 5, 6
Groups C and D Endpoints	1

**NOTE:**

- PDA applies to Subgroup 1 only.

**Die Characteristics**

**DIE DIMENSIONS:**

65 x 60 x 19 mils ± 1 mils  
 1640µm x 1520µm x 483µm ± 25.4µm

**METALLIZATION:**

Type: Al, 1% Cu  
 Thickness: 16kÅ ± 2kÅ

**WORST CASE CURRENT DENSITY:**

$5.77 \times 10^4$  A/cm<sup>2</sup> at 30mA

**SUBSTRATE POTENTIAL (Powered Up): V-**

**GLASSIVATION:**

Type: Nitride over Silox  
 Silox Thickness: 12kÅ ± 2kÅ  
 Nitride Thickness: 3.5kÅ ± 1kÅ

**TRANSISTOR COUNT: 62**

**PROCESS: Bipolar Dielectric Isolation**

**Metallization Mask Layout**

HA-5020/883

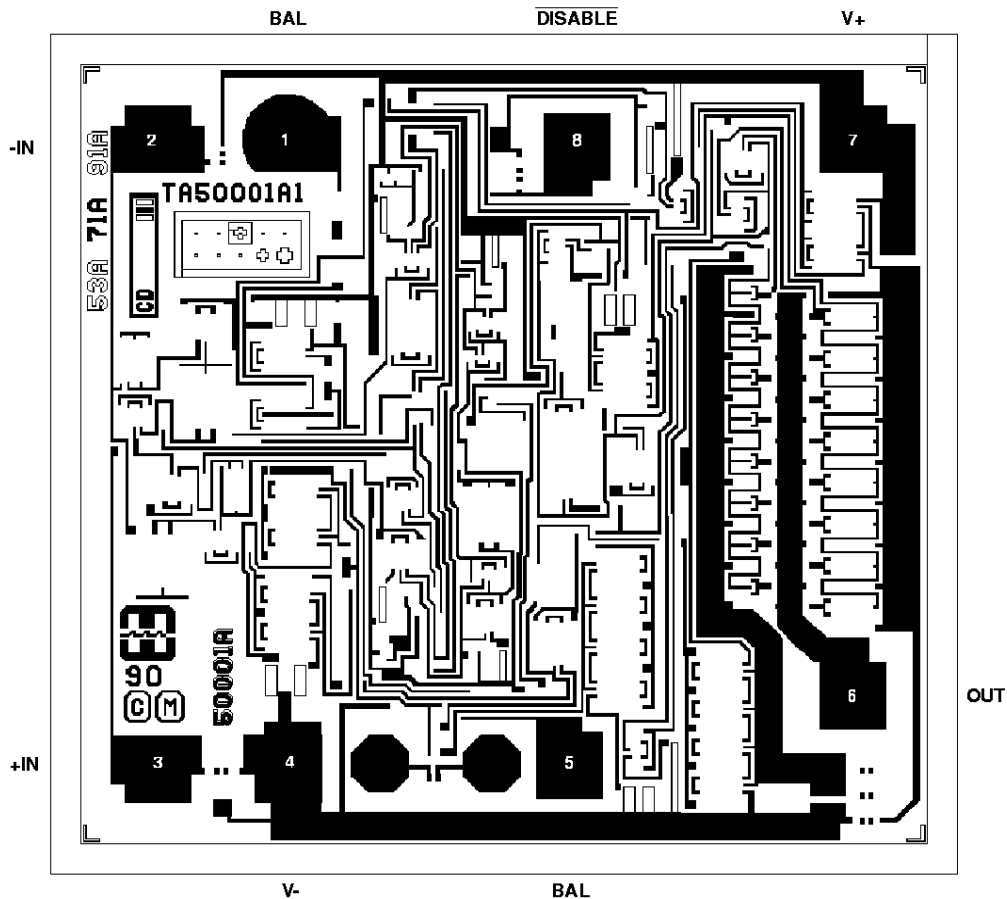

**Test Circuit** (Applies to Table 1)

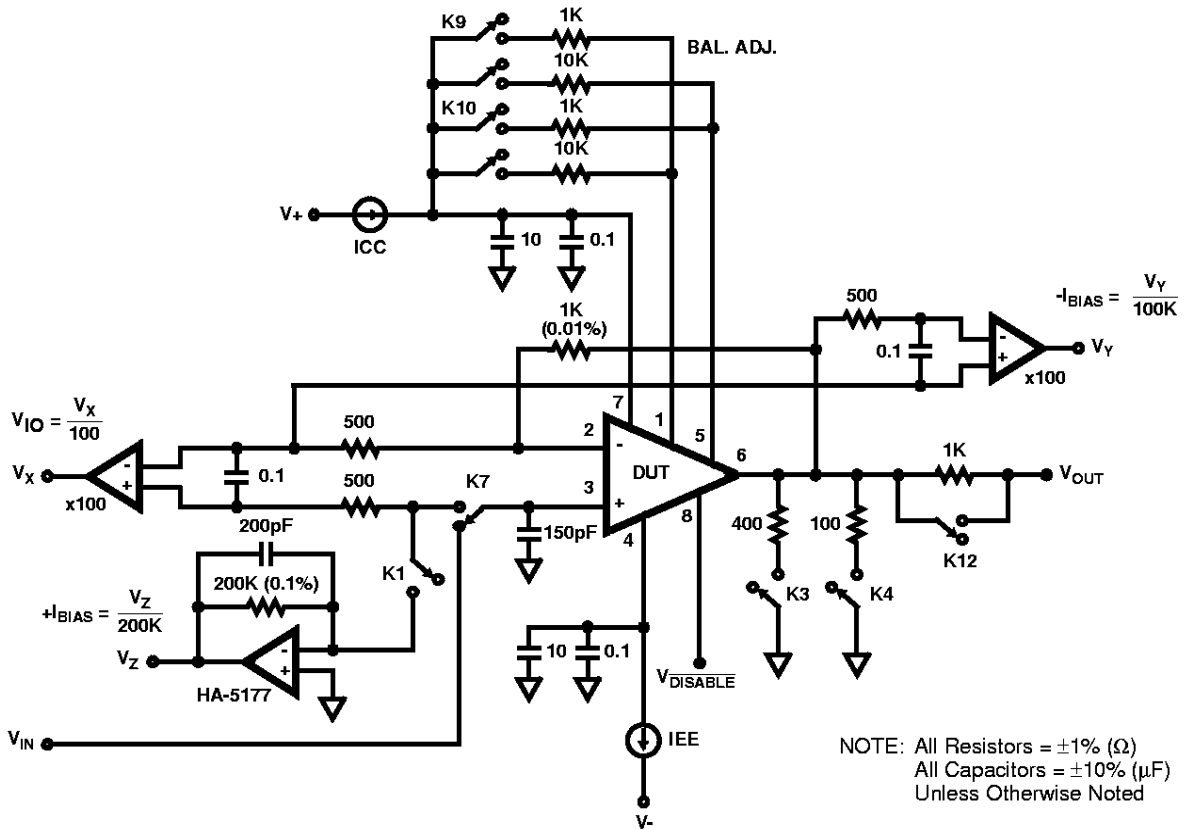

**Test Waveforms**

SIMPLIFIED TEST CIRCUIT FOR LARGE AND SMALL SIGNAL PULSE RESPONSE (Applies to Tables 2 and 3)

**$A_v = +1$  TEST CIRCUIT**

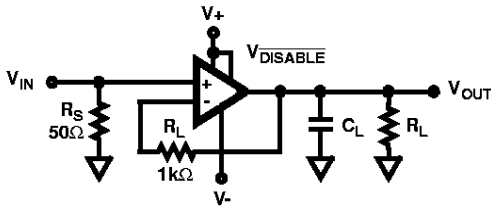

NOTE:  $V_S = \pm 15V$ ,  $A_v = +1$ ,  $C_L \leq 10pF$   
 $R_F = 1k\Omega$ ,  $R_S = 50\Omega$   
 $R_L = 400\Omega$  For Large Signal  
 $R_L = 100\Omega$  For Small Signal

**$A_v = +10$  TEST CIRCUIT**

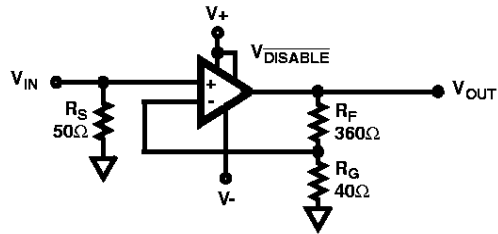

NOTE:  $V_S = \pm 15V$ ,  $A_v = +10$ ,  $C_L \leq 10pF$   
 $R_F = 360\Omega$ ,  $R_G = 40\Omega$   
 $R_S = 50\Omega$ ,  $R_L = \text{Open}$

**LARGE SIGNAL WAVEFORM**

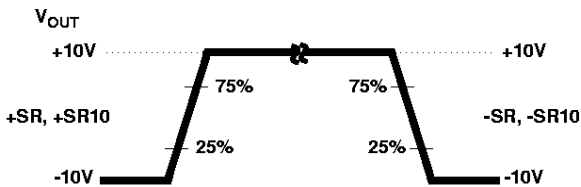

NOTE:  $A_v = +1$ : +SR, -SR  
 $A_v = +10$ : +SR10, -SR10

**SMALL SIGNAL WAVEFORM**

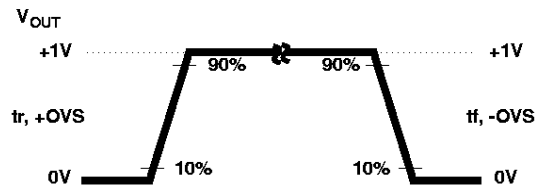

**Test Waveforms (Continued)**

SIMPLIFIED TEST CIRCUIT FOR ENABLE/DISABLE TIMES

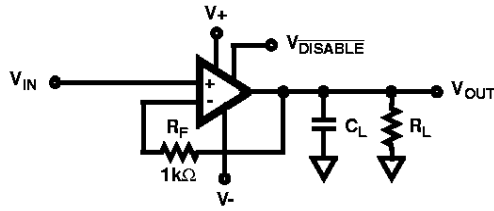

NOTE:  $V_S = \pm 15V$ ,  $A_V = +1$ ,  $C_L \leq 10pF$   
 $R_F = 1k\Omega$ ,  $R_L = 400\Omega$

POSITIVE ENABLE/DISABLE SWITCHING WAVEFORMS

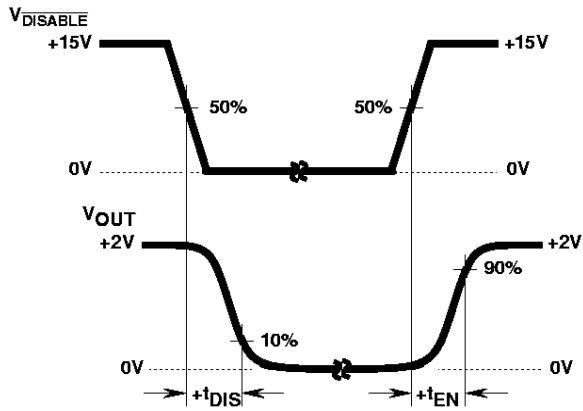

NEGATIVE ENABLE/DISABLE SWITCHING WAVEFORMS

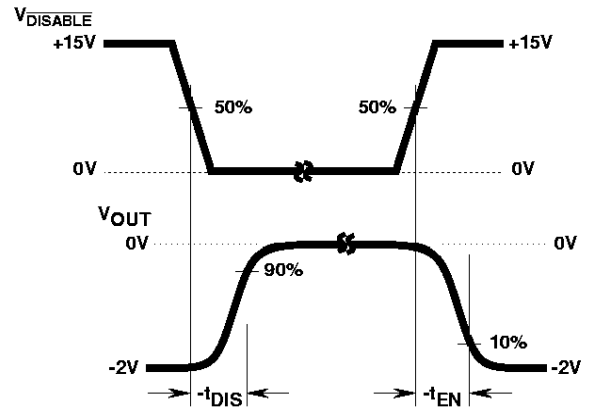



# HA-5020/883

## Burn-In Circuits

HA7-5020/883 CERAMIC DIP

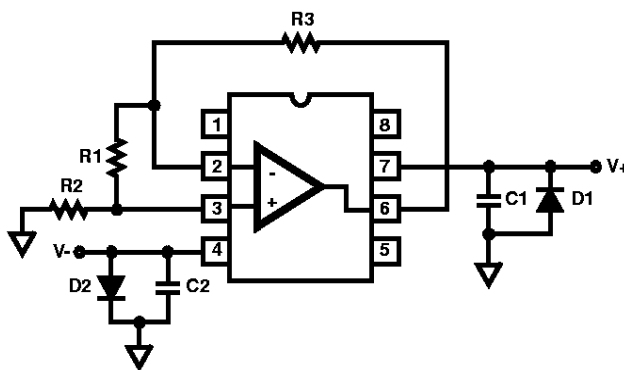

HA4-5020/883 CERAMIC LCC

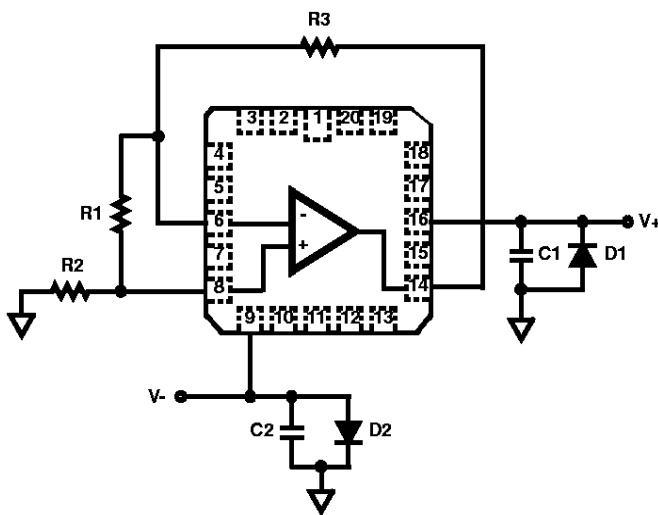

NOTES:

$R_1 = R_2 = 1k\Omega, \pm 5\%$  (Per Socket)

$R_3 = 10k\Omega, \pm 5\%$  (Per Socket)

$C_2 = C_3 = 0.01\mu F$  (Per Socket) or  $0.1\mu F$  (Per Row) Minimum

$D_1 = D_2 = 1N4002$  or Equivalent

$(V+) - (V-) = 31V \pm 1V$

Schematic Diagram

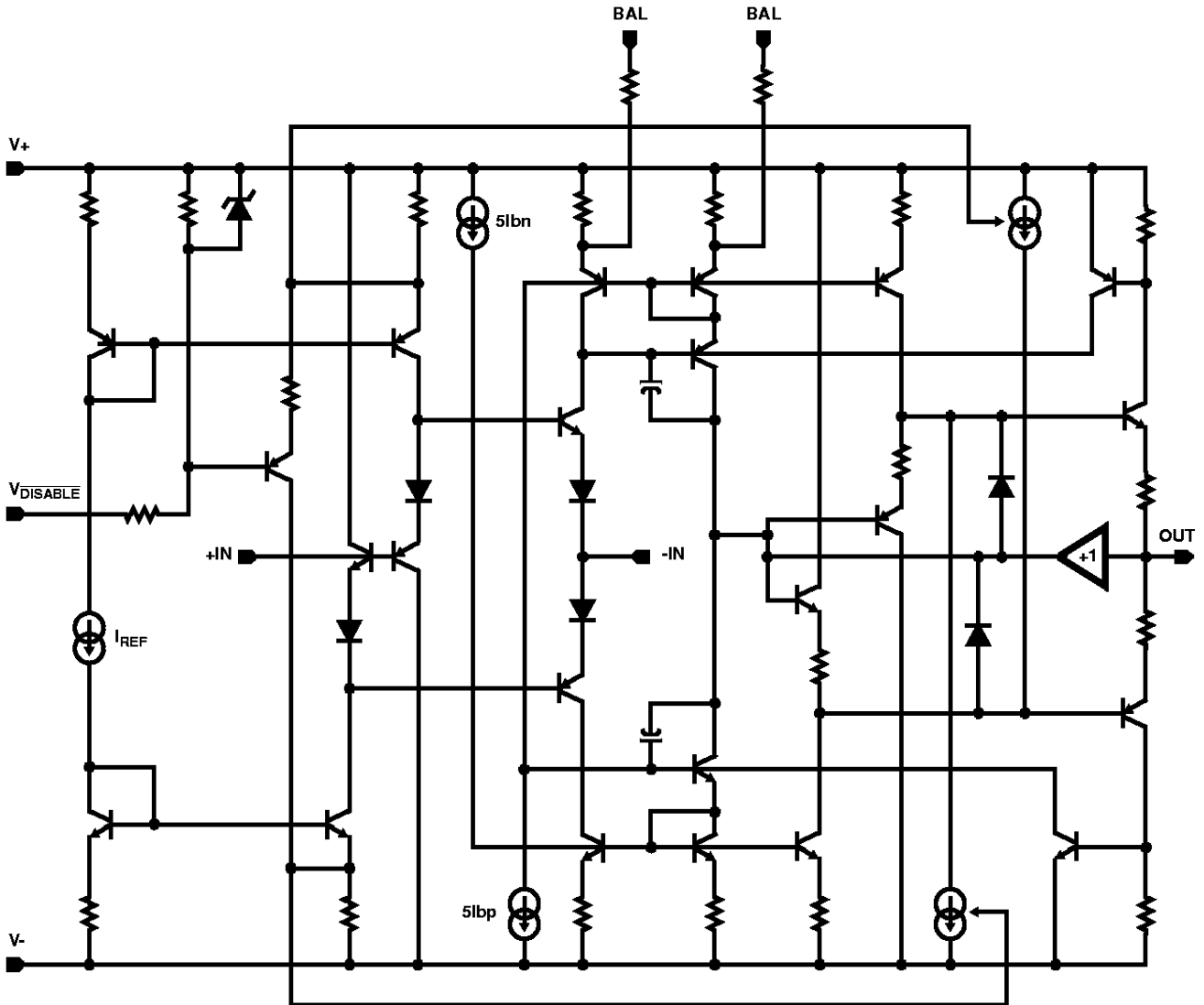

**Packaging**

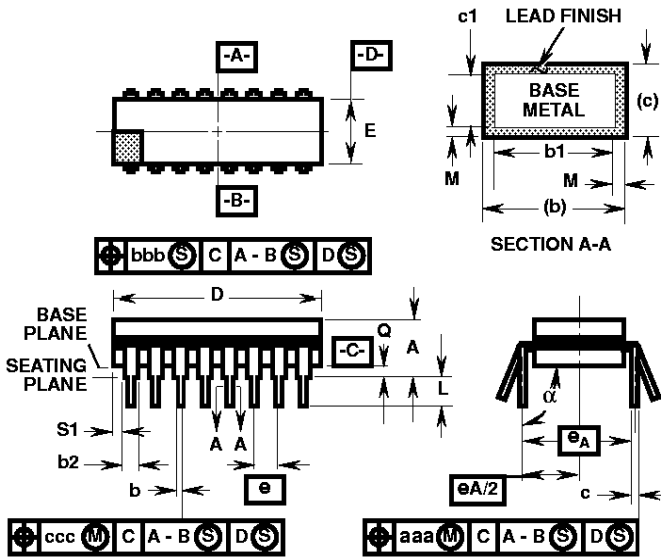

**F8.3A MIL-STD-1835 GDIP1-T8 (D-4, CONFIGURATION A)  
8 LEAD DUAL-IN-LINE FRIT-SEAL CERAMIC PACKAGE**

SYMBOL	INCHES		MILLIMETERS		NOTES
	MIN	MAX	MIN	MAX	
A	-	0.200	-	5.08	-
b	0.014	0.026	0.36	0.66	2
b1	0.014	0.023	0.36	0.58	3
b2	0.045	0.065	1.14	1.65	-
b3	0.023	0.045	0.58	1.14	4
c	0.008	0.018	0.20	0.46	2
c1	0.008	0.015	0.20	0.38	3
D	-	0.405	-	10.29	5
E	0.220	0.310	5.59	7.87	5
e	0.100 BSC		2.54 BSC		-
eA	0.300 BSC		7.62 BSC		-
eA/2	0.150 BSC		3.81 BSC		-
L	0.125	0.200	3.18	5.08	-
Q	0.015	0.060	0.38	1.52	6
S1	0.005	-	0.13	-	7
S2	0.005	-	0.13	-	-
alpha	90°	105°	90°	105°	-
aaa	-	0.015	-	0.38	-
bbb	-	0.030	-	0.76	-
ccc	-	0.010	-	0.25	-
M	-	0.0015	-	0.038	2
N	8		8		8

**NOTES:**

1. Index area: A notch or a pin one identification mark shall be located adjacent to pin one and shall be located within the shaded area shown. The manufacturer's identification shall not be used as a pin one identification mark.
2. The maximum limits of lead dimensions b and c or M shall be measured at the centroid of the finished lead surfaces, when solder dip or tin plate lead finish is applied.
3. Dimensions b1 and c1 apply to lead base metal only. Dimension M applies to lead plating and finish thickness.
4. Corner leads (1, N, N/2, and N/2+1) may be configured with a partial lead paddle. For this configuration dimension b3 replaces dimension b1.
5. This dimension allows for off-center lid, meniscus, and glass overrun.
6. Dimension Q shall be measured from the seating plane to the base plane.
7. Measure dimension S1 at all four corners.
8. N is the maximum number of terminal positions.
9. Dimensioning and tolerancing per ANSI Y14.5M - 1982.
10. Controlling Dimension: Inch.
11. Lead Finish: Type A.
12. Materials: Compliant to MIL-M-38510.

Packaging (Continued)

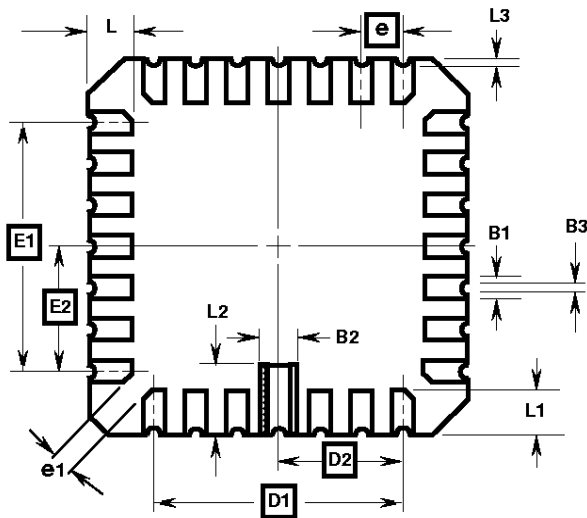
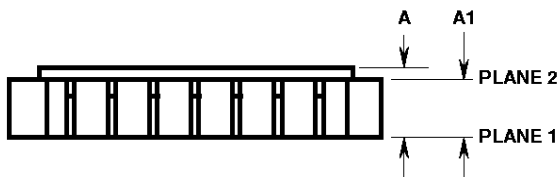
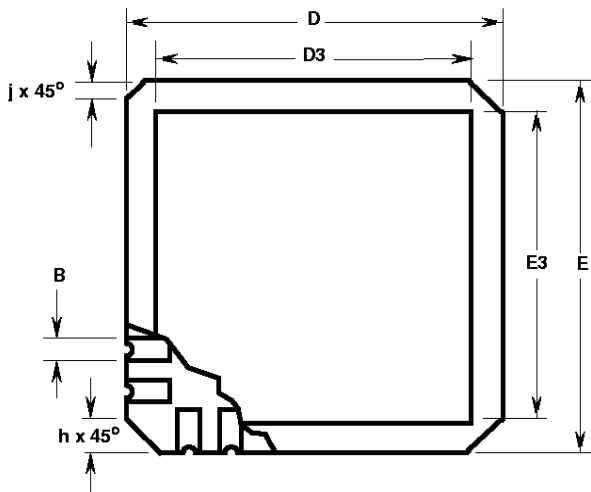

**J20.A MIL-STD-1835 CQCC1-N20 (C-2)**  
**20 PAD METAL SEAL LEADLESS CERAMIC CHIP CARRIER**

SYMBOL	INCHES		MILLIMETERS		NOTES
	MIN	MAX	MIN	MAX	
A	0.060	0.100	1.52	2.54	6, 7
A1	0.050	0.088	1.27	2.23	7
B	-	-	-	-	4
B1	0.022	0.028	0.56	0.71	2, 4
B2	0.072 REF		1.83 REF		-
B3	0.006	0.022	0.15	0.56	-
D	0.342	0.358	8.69	9.09	-
D1	0.200 BSC		5.08 BSC		-
D2	0.100 BSC		2.54 BSC		-
D3	-	0.358	-	9.09	2
E	0.342	0.358	8.69	9.09	-
E1	0.200 BSC		5.08 BSC		-
E2	0.100 BSC		2.54 BSC		-
E3	-	0.358	-	9.09	2
e	0.050 BSC		1.27 BSC		-
e1	0.015	-	0.38	-	2
h	0.040 REF		1.02 REF		5
j	0.020 REF		0.51 REF		5
L	0.045	0.055	1.14	1.40	-
L1	0.045	0.055	1.14	1.40	-
L2	0.075	0.095	1.90	2.41	-
L3	0.003	0.015	0.08	0.38	-
ND	5		5		3
NE	5		5		3
N	20		20		3

NOTES:

1. Metallized castellations shall be connected to plane 1 terminals and extend toward plane 2 across at least two layers of ceramic or completely across all of the ceramic layers to make electrical connection with the optional plane 2 terminals.
2. Unless otherwise specified, a minimum clearance of 0.015 inch (0.381mm) shall be maintained between all metallized features (e.g., lid, castellations, terminals, thermal pads, etc.)
3. Symbol "N" is the maximum number of terminals. Symbols "ND" and "NE" are the number of terminals along the sides of length "D" and "E", respectively.
4. The required plane 1 terminals and optional plane 2 terminals shall be electrically connected.
5. The corner shape (square, notch, radius, etc.) may vary at the manufacturer's option, from that shown on the drawing.
6. Chip carriers shall be constructed of a minimum of two ceramic layers.
7. Maximum limits allows for 0.007 inch solder thickness on pads.
8. Lead Finish: Type A.
9. Materials: Compliant to MIL-M-38510.

## DESIGN INFORMATION

February 1996

## 100MHz Current Feedback Video Amplifier with Disable

The information contained in this section has been developed through characterization by Harris Semiconductor and is for use as application and design information only. No guarantee is implied.

**Typical Performance Curves**  $V_{SUPPLY} = \pm 15V$ ,  $A_V = +1$ ,  $R_F = 1k\Omega$ ,  $R_L = 400\Omega$ ,  $T_A = +25^\circ C$ , Unless Otherwise Specified

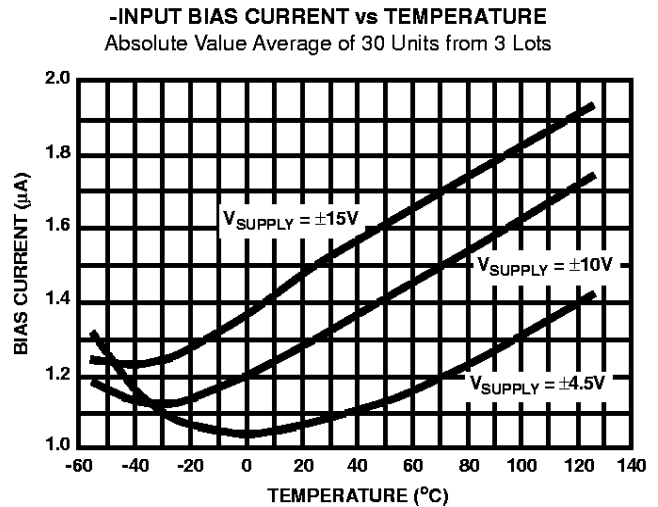
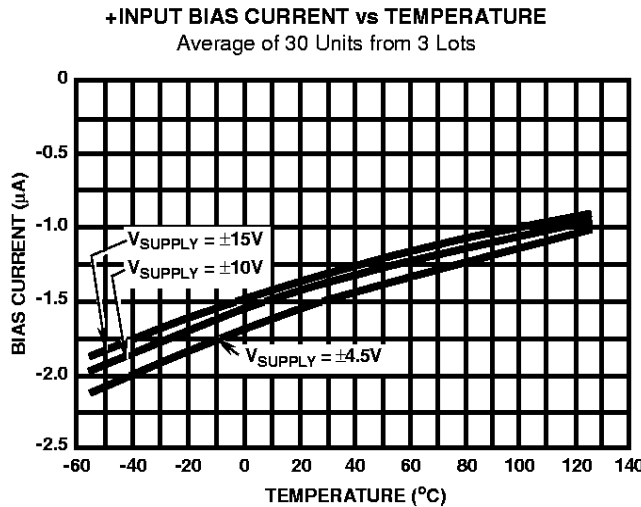
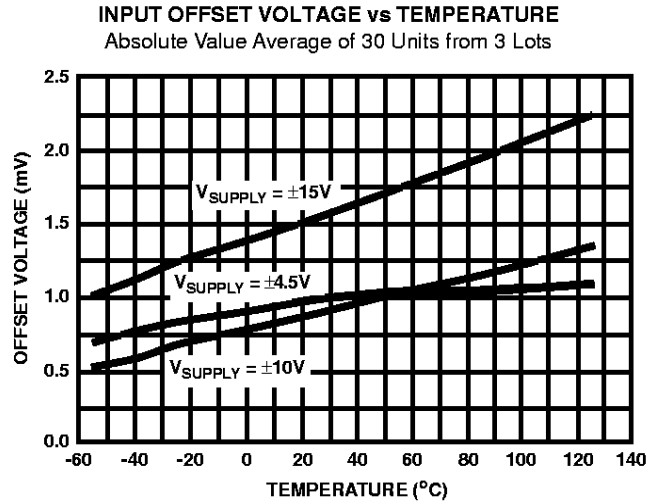
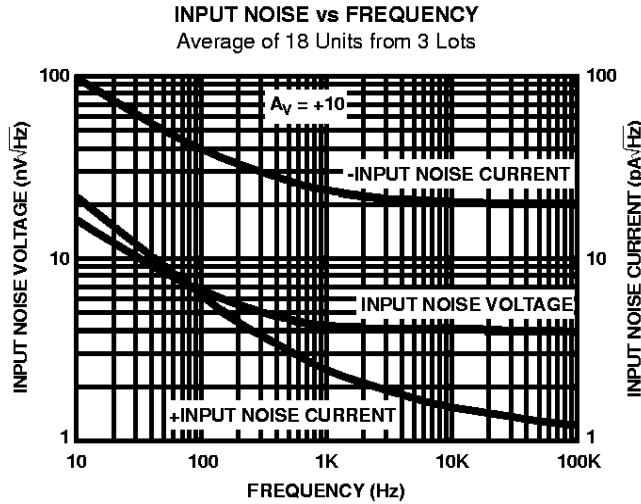

## DESIGN INFORMATION (Continued)

The information contained in this section has been developed through characterization by Harris Semiconductor and is for use as application and design information only. No guarantee is implied.

**Typical Performance Curves**  $V_{SUPPLY} = \pm 15V$ ,  $A_V = +1$ ,  $R_F = 1k\Omega$ ,  $R_L = 400\Omega$ ,  $T_A = +25^\circ C$ , Unless Otherwise Specified

**TRANSIMPEDANCE vs TEMPERATURE**  
Average of 30 Units from 3 Lots

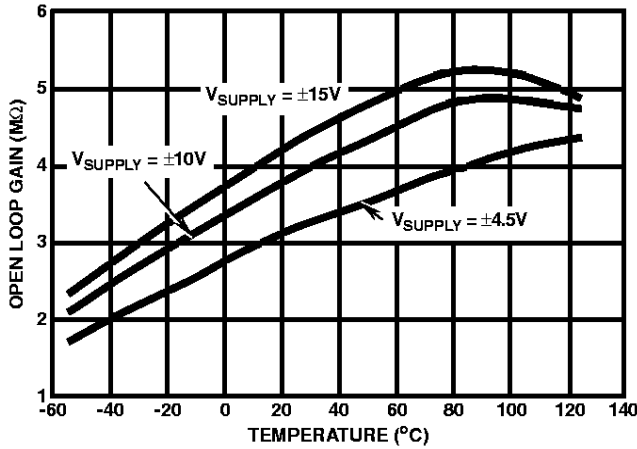

**SUPPLY CURRENT vs SUPPLY VOLTAGE**  
Average of 30 Units from 3 Lots

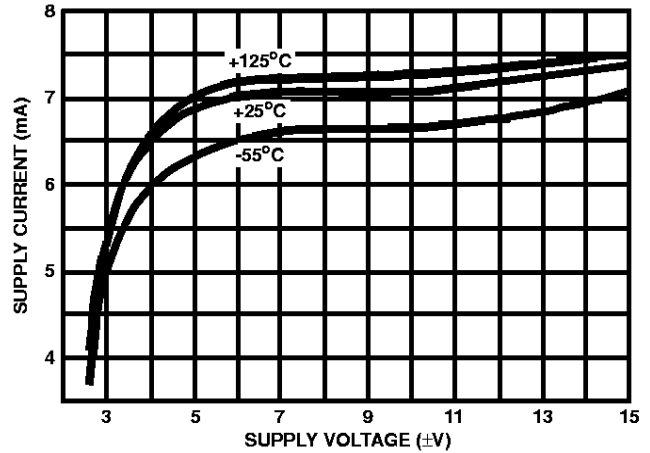

**DISABLE SUPPLY CURRENT vs SUPPLY VOLTAGE**  
Average of 30 Units from 3 Lots

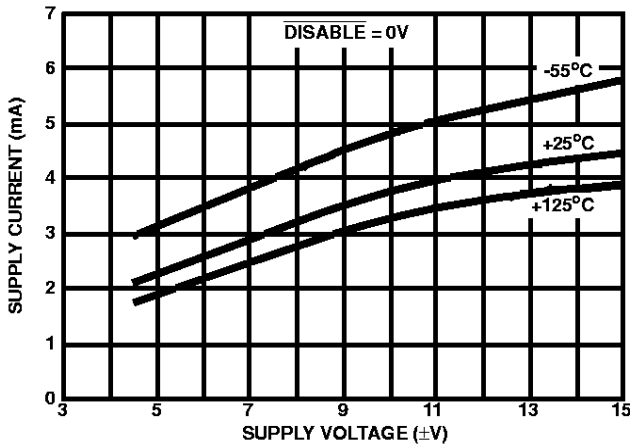

**SUPPLY CURRENT vs DISABLE INPUT VOLTAGE**

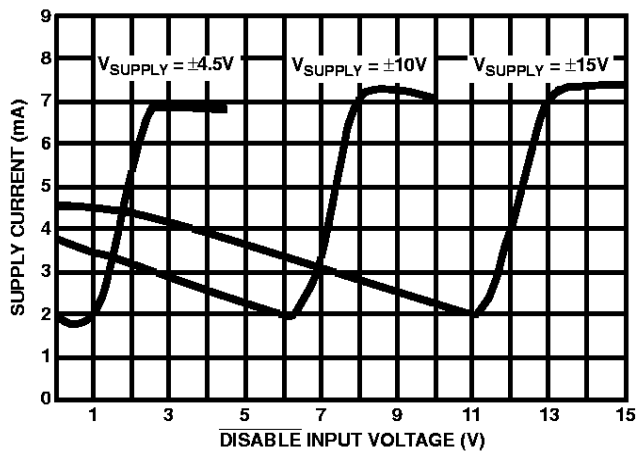

**DISABLE MODE FEEDTHROUGH vs FREQUENCY**

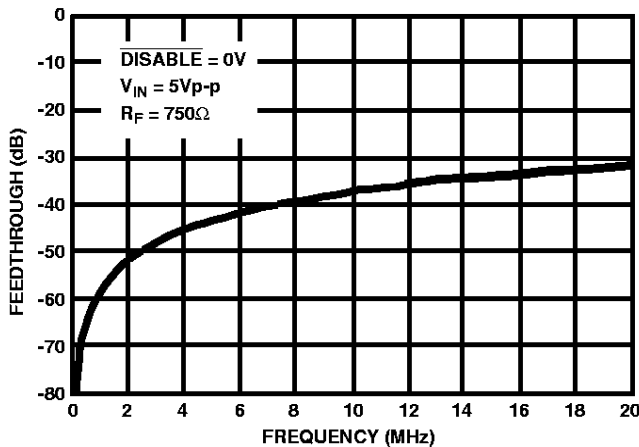

**DISABLED OUTPUT LEAKAGE vs TEMPERATURE**  
Average of 30 Units from 3 Lots

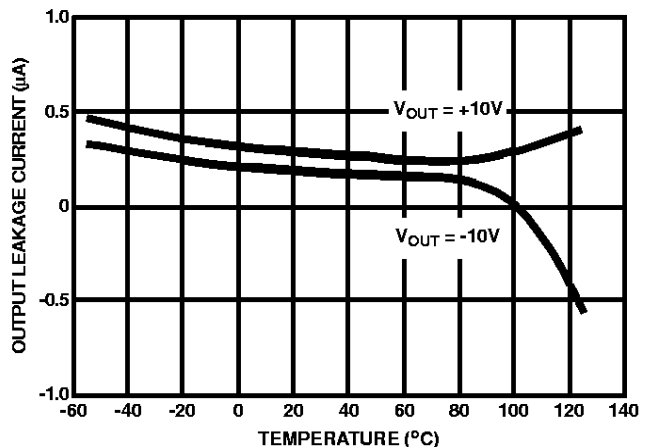

# DESIGN INFORMATION (Continued)

The information contained in this section has been developed through characterization by Harris Semiconductor and is for use as application and design information only. No guarantee is implied.

**Typical Performance Curves**  $V_{SUPPLY} = \pm 15V$ ,  $A_V = +1$ ,  $R_F = 1k\Omega$ ,  $R_L = 400\Omega$ ,  $T_A = +25^\circ C$ , Unless Otherwise Specified

**ENABLE/DISABLE TIME vs OUTPUT VOLTAGE**  
Average of 9 Units from 3 Lots

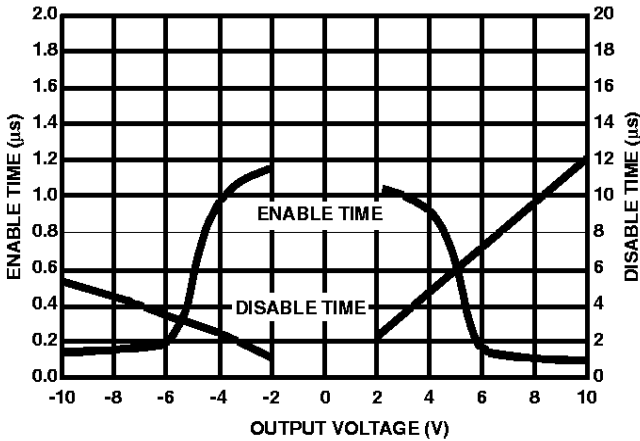

**NON-INVERTING GAIN vs FREQUENCY**

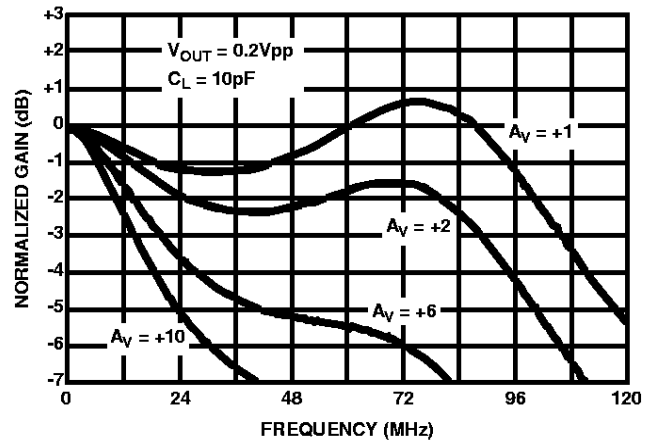

**INVERTING FREQUENCY RESPONSE**

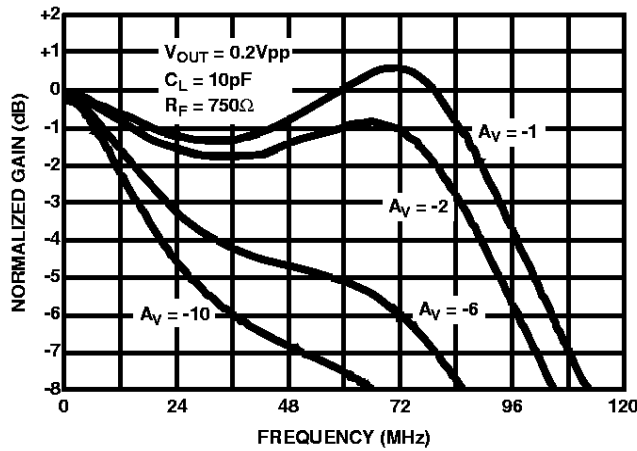

**PHASE vs FREQUENCY**

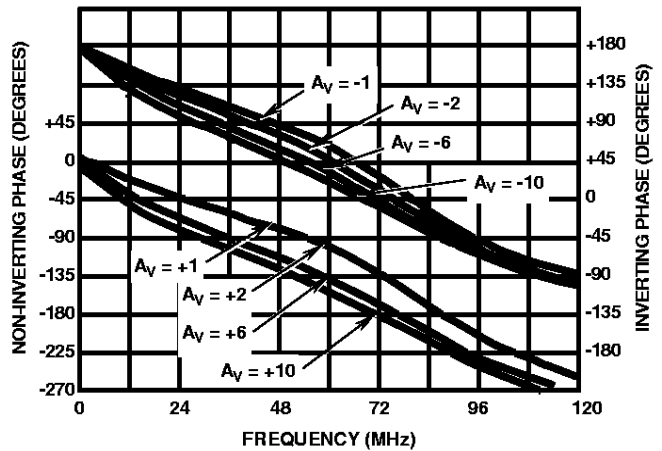

**BANDWIDTH AND GAIN PEAKING vs LOAD RESISTANCE**

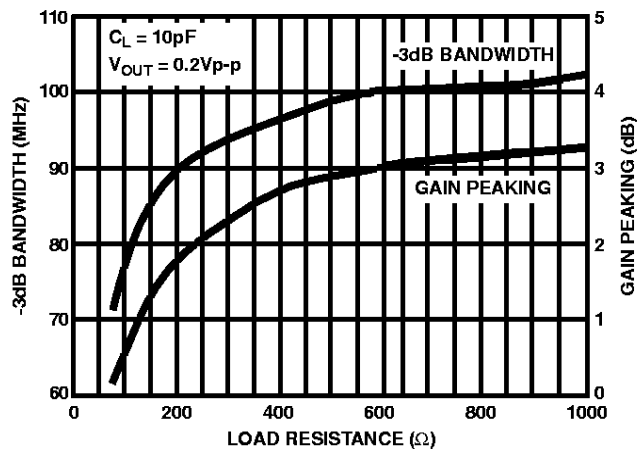

**BANDWIDTH AND GAIN PEAKING vs FEEDBACK RESISTANCE**

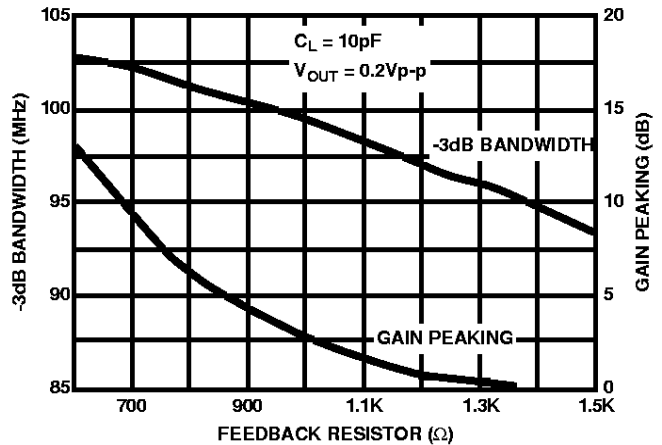

## DESIGN INFORMATION (Continued)

The information contained in this section has been developed through characterization by Harris Semiconductor and is for use as application and design information only. No guarantee is implied.

**Typical Performance Curves**  $V_{SUPPLY} = \pm 15V$ ,  $A_V = +1$ ,  $R_F = 1k\Omega$ ,  $R_L = 400\Omega$ ,  $T_A = +25^\circ C$ , Unless Otherwise Specified

**BANDWIDTH AND GAIN PEAKING vs FEEDBACK RESISTANCE**  
( $A_V = +2$ )

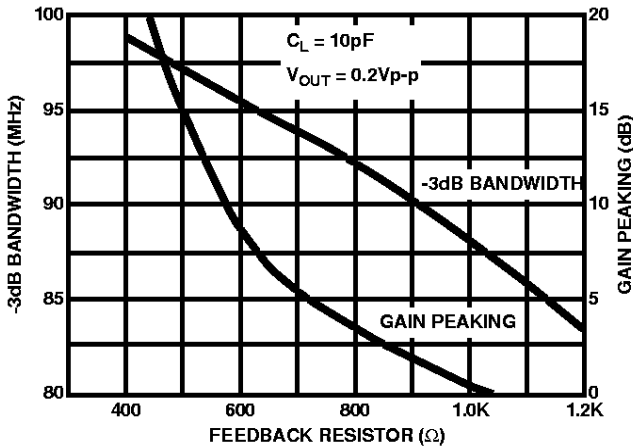

**BANDWIDTH vs FEEDBACK RESISTANCE**  
( $A_V = +10$ )

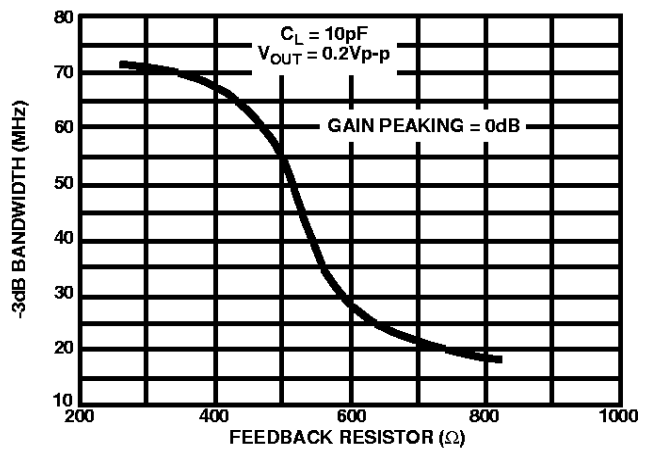

**REJECTION RATIOS vs TEMPERATURE**  
Average of 30 Units from 3 Lots

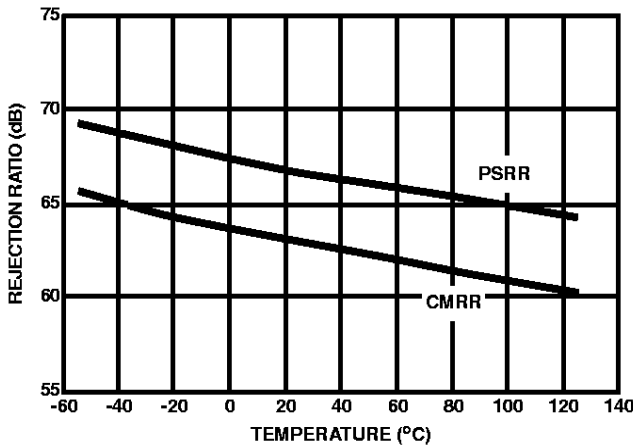

**REJECTION RATIOS vs FREQUENCY**

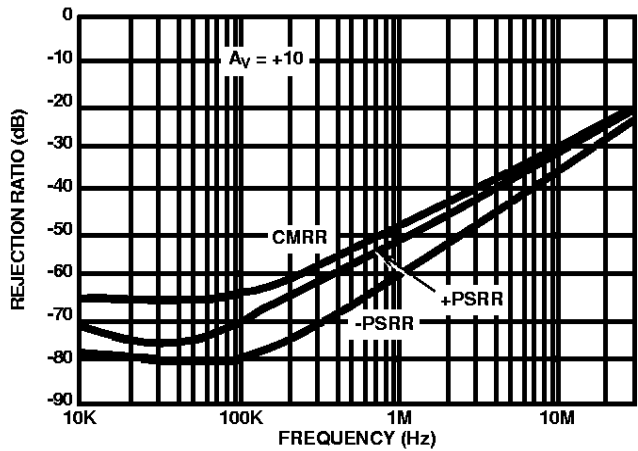

**OUTPUT SWING OVERHEAD vs TEMPERATURE**  
Average of 30 Units from 3 Lots

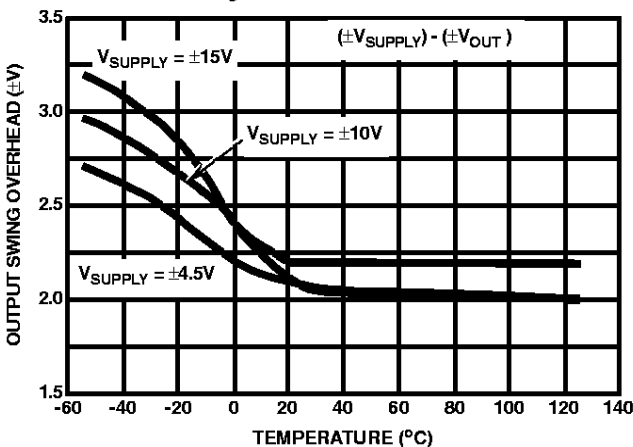

**OUTPUT VOLTAGE SWING vs LOAD RESISTANCE**

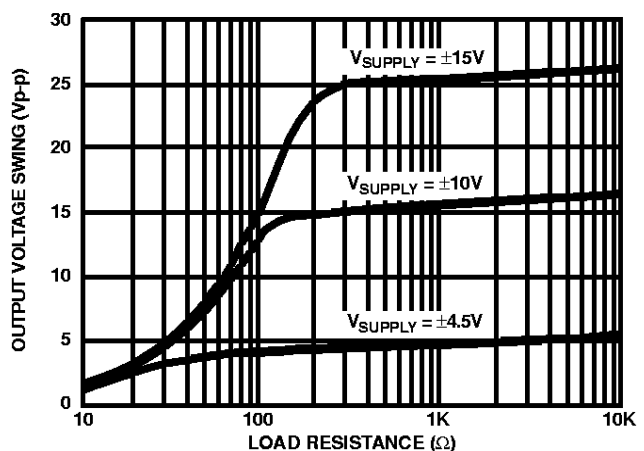



## DESIGN INFORMATION (Continued)

The information contained in this section has been developed through characterization by Harris Semiconductor and is for use as application and design information only. No guarantee is implied.

**Typical Performance Curves**  $V_{SUPPLY} = \pm 15V$ ,  $A_V = +1$ ,  $R_F = 1k\Omega$ ,  $R_L = 400\Omega$ ,  $T_A = +25^\circ C$ , Unless Otherwise Specified

**SHORT CIRCUIT CURRENT LIMIT vs TEMPERATURE**

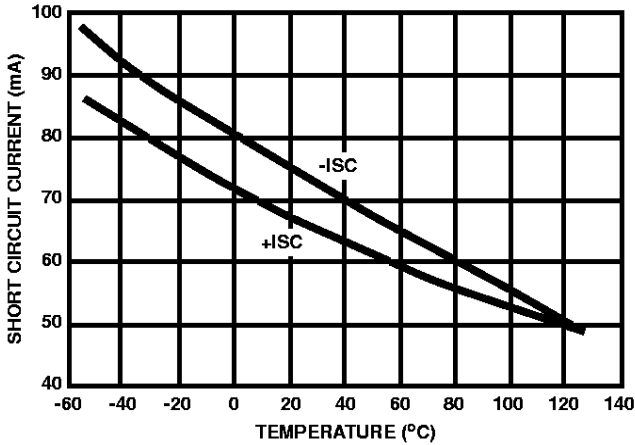

**SMALL SIGNAL PULSE RESPONSE**

Vertical Scale:  $V_{IN} = 100mV/Div.$ ;  $V_{OUT} = 100mV/Div.$   
Horizontal Scale: 20ns/Div.

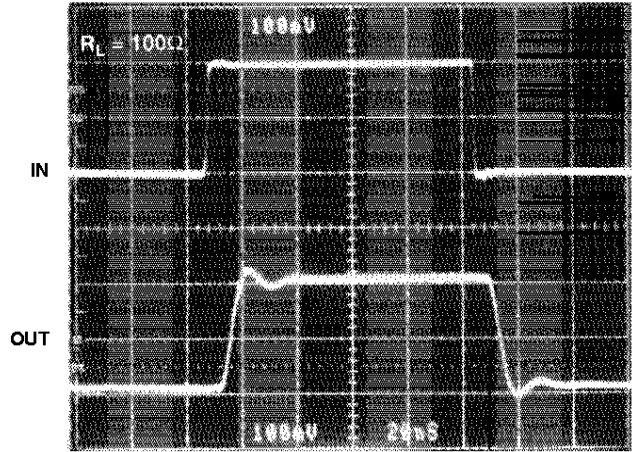

**LARGE SIGNAL PULSE RESPONSE**

Vertical Scale:  $V_{IN} = 5V/Div.$ ;  $V_{OUT} = 5V/Div.$   
Horizontal Scale: 50ns/Div.

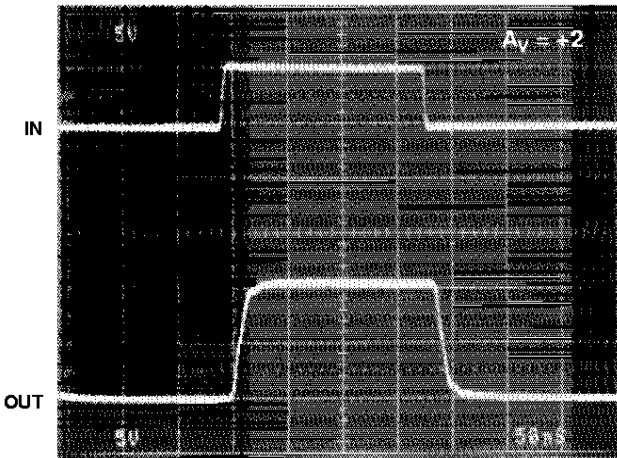

**PROPAGATION DELAY vs TEMPERATURE**

Average of 18 Units from 3 Lots

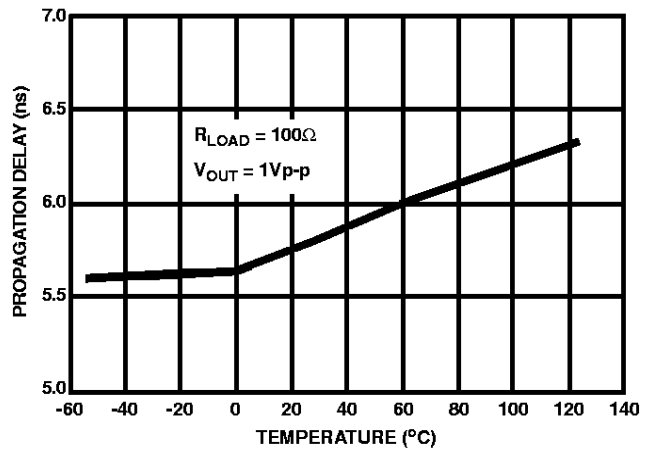

# DESIGN INFORMATION (Continued)

The information contained in this section has been developed through characterization by Harris Semiconductor and is for use as application and design information only. No guarantee is implied.

**Typical Performance Curves**  $V_{SUPPLY} = \pm 15V$ ,  $A_V = +1$ ,  $R_F = 1k\Omega$ ,  $R_L = 400\Omega$ ,  $T_A = +25^\circ C$ , Unless Otherwise Specified

**PROPAGATION DELAY vs SUPPLY VOLTAGE**  
Average of 18 Units from 3 Lots

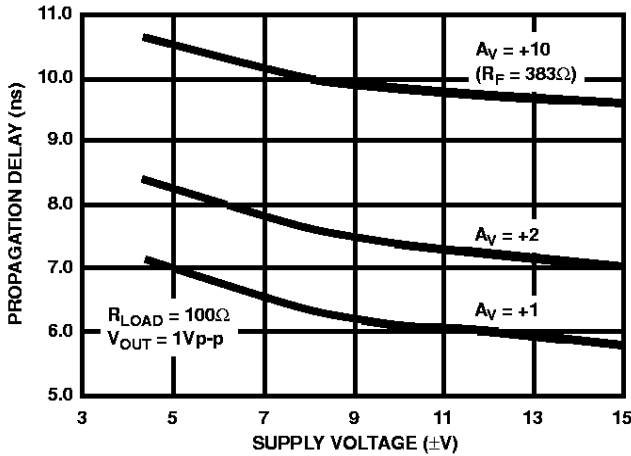

**SMALL SIGNAL OVERSHOOT vs LOAD RESISTANCE**

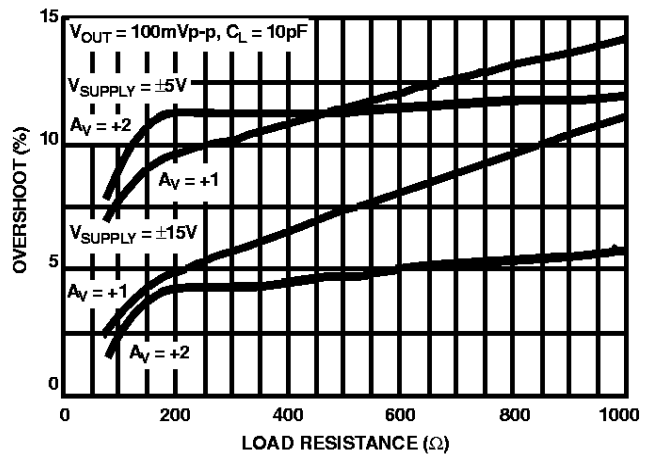

**DISTORTION vs FREQUENCY**

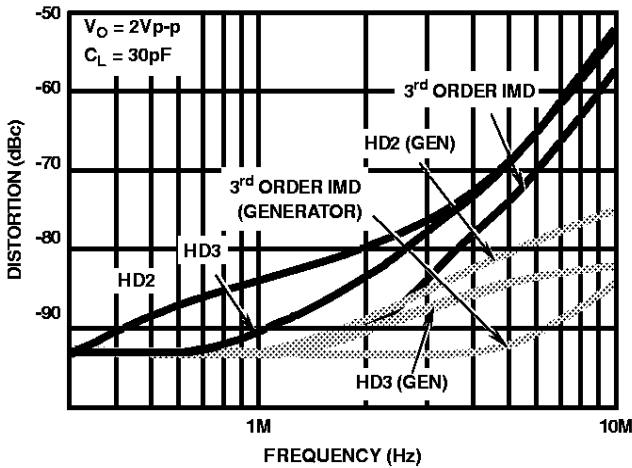

**DIFFERENTIAL GAIN vs SUPPLY VOLTAGE**  
Average of 18 Units from 3 Lots

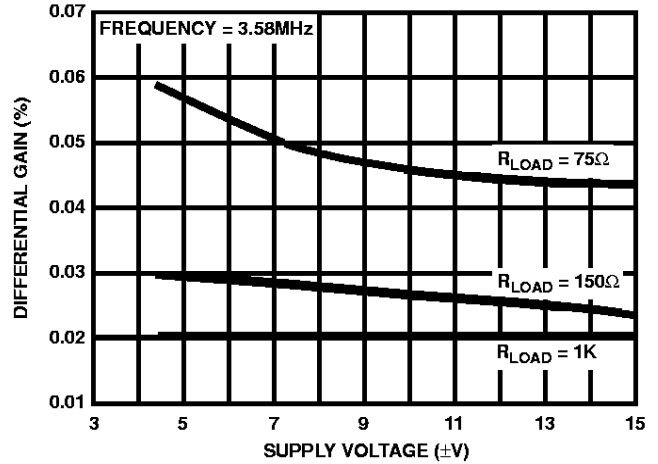

**DIFFERENTIAL PHASE vs SUPPLY VOLTAGE**  
Average of 18 Units from 3 Lots

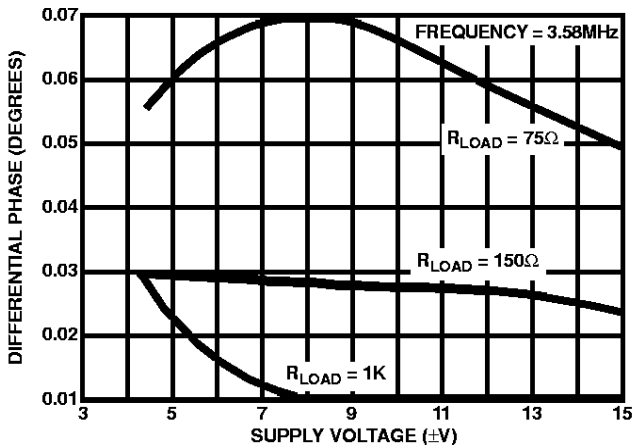

**SLEW RATE vs TEMPERATURE**  
Average of 30 Units from 3 Lots

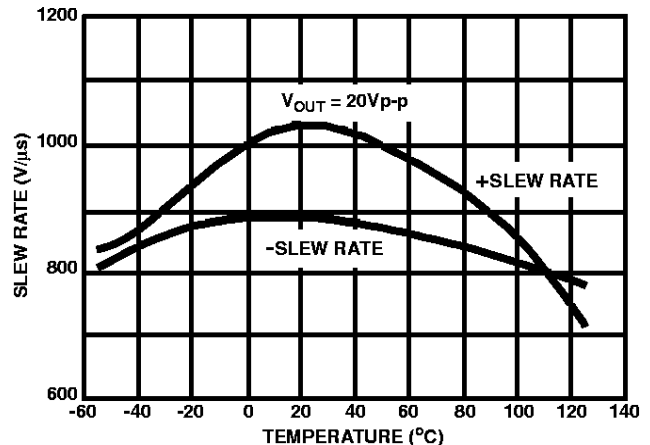

**DESIGN INFORMATION** (Continued)

The information contained in this section has been developed through characterization by Harris Semiconductor and is for use as application and design information only. No guarantee is implied.

**TYPICAL PERFORMANCE CHARACTERISTICS**

Device Characterized at: Supply Voltage =  $\pm 15\text{V}$ ,  $R_F = 1\text{k}\Omega$ ,  $A_V = +1\text{V/V}$ ,  $R_L = 400\Omega$ ,  $C_L \leq 10\text{pF}$ ,  $V_{\text{DISABLE}} = V+$ , Unless Otherwise Specified

PARAMETERS	CONDITIONS	TEMPERATURE	TYPICAL	DESIGN LIMIT	UNITS
Input Offset Voltage	$V_{\text{CM}} = 0\text{V}$	$+25^\circ\text{C}$	2	Table 1	mV
Average Offset Voltage Drift	Versus Temperature	Full	10	15	$\mu\text{V}/^\circ\text{C}$
Positive Input Bias Current	$V_{\text{CM}} = 0\text{V}$	$+25^\circ\text{C}$	3	Table 1	$\mu\text{A}$
Negative Input Bias Current	$V_{\text{CM}} = 0\text{V}$	$+25^\circ\text{C}$	12	Table 1	$\mu\text{A}$
Input Common Mode Range		Full	$\pm 12$	Table 1	V
Offset Voltage Adjustment	See Note 4, Table 1	Full	$\pm 40$	Table 1	mV
Output Voltage Swing	$V_{\text{IN}} = \pm 12.8$	$+25^\circ\text{C}$ to $+125^\circ\text{C}$	$\pm 12.7$	Table 1	V
	$V_{\text{IN}} = \pm 12.8$	$-55^\circ\text{C}$ to $0^\circ\text{C}$	$\pm 11.8$	Table 1	V
Output Current	Implied by $V_{\text{OUT}}/400\Omega$	$+25^\circ\text{C}$	31.7	Table 1	mA
Output Short Circuit Current	$V_{\text{IN}} = \pm 10\text{V}$ , $V_{\text{OUT}} = 0\text{V}$	$+25^\circ\text{C}$	65	Table 1	mA
Quiescent Supply Current	$R_L = \text{Open}$	Full	7.5	Table 1	mA
Supply Current, Disabled	$R_L = \text{Open}$ , $V_{\text{DIS}} = 0\text{V}$	Full	5.0	Table 1	mA
Slew Rate	$V_{\text{IN}} = 20\text{Vp-p}$	$+25^\circ\text{C}$	$\pm 800$	Table 2	$\text{V}/\mu\text{s}$
Overshoot	$V_O = 1\text{Vp-p}$ , $R_L = 100\Omega$	$+25^\circ\text{C}$	7	Table 3	%
Input Noise Voltage	$f = 1\text{kHz}$	$+25^\circ\text{C}$	4.5	8	$\text{nV}/\sqrt{\text{Hz}}$
Positive Input Noise Current	$f = 1\text{kHz}$	$+25^\circ\text{C}$	2.5	4	$\text{pA}/\sqrt{\text{Hz}}$
Negative Input Noise Current	$f = 1\text{kHz}$	$+25^\circ\text{C}$	25	40	$\text{pA}/\sqrt{\text{Hz}}$
Differential Gain	$R_L = 150\Omega$ , NTC-7 Composite	$+25^\circ\text{C}$	0.025	0.05	%
Differential Phase	$R_L = 150\Omega$ , NTC-7 Composite	$+25^\circ\text{C}$	0.025	0.05	Degrees